

Ordering Table — Standard Rocker & Paddle Switches

HOW TO ORDER YOUR DESIGN (Bold Face Type indicates items normally in Distributor Stock)

Following the table from left to right, the designer is able to specify the options wanted. The options are described and illustrated on pages 24-31. Refer to page 57 for mounting hardware.

To determine a part number select the options desired and fill in the boxes in the selection guides illustrated below.

Rocker Switch Selection Guide



Series	Poles and Throw		Circuits ①				Actuator Options		Terminal Options ⑥		Contact Material		Actuator Color		Bezels		Other Option															
	No.	Code	Description			Code	Type	Code	Type	Code	Type	Code	Color	Code	Type	Code	Type															
B	SPDT	1			POS. "C"		Rocker ⑦ (Screw Mount)	J1	Right Angle PC ⑩	A	gold/brass	B	Dark Gray ④	0	Bright Chrome ③	1M	Epoxy Sealed Terminals ⑥															
	DPDT	2	ON	OFF	ON	21	Paddle ⑦ (Screw Mount)	J2	Vertical PC .100 Spacing	AV1	gold/silver	G	White	1	Black ③	2M																
	3PDT	3	ON	NONE	ON	23	Rocker ⑦ (Screw Mount)	J3	Vertical PC .150 Spacing	AV2	coin silver	Q	Black	2	Satin Chrome ③	3M																
	4PDT	4	ON	NONE	ON*	26	Paddle ⑦ (Screw Mount)	J5			⑫	K	Red	3	White ②	1P																
																		ON*	OFF	ON*	27	Snap-In Mount Rocker With Bezel	J11	PC Terminals	C	⑫	L	Green ④	5	Black ②	2P	
																		ON	OFF	ON*	31	Snap-In Mount Paddle With Bezel	J21	PC & Support ①	V3	⑫	M	Blue ④	6	Red ②	3P	
																		ON	ON	ON	32	Snap-In Mount Paddle With Bezel	J21	PC & Support ①	V4			Light Gray ④	8	Black w/LED ②	4P	
																		ON	ON	ON*	33	Large ⑦ Snap-In Mount Rocker With Bezel	J37	Vertical PC .150 Spacing	V5			Yellow ④	9	Green ② ④	5P	
																		NONE	ON	ON*	34 ⑤	Large ⑦ Snap-In Mount Paddle With Bezel	J47	PC & Support ①	V6			Brown ④	10	Blue ② ④	6P	
																		ON*	ON	ON*	35	Snap-In Mount Paddle With Bezel	J47	PC & Support ①	V7					Light Gray ② ④	8P	
																		NONE	ON	ON	53 ⑤	Snap-In Rocker ① ⑦	J50	.750 Wire Wrap	W					Yellow ② ④	9P	
																						Snap-In Rocker ① ⑦	J53	.964 Wire Wrap	W1					Dark Gray ② ④	0P	
																						Snap-In Paddle ① ⑦	J60	.425 Wire Wrap	W3							
																						Snap-In Paddle ① ⑦	J63	1.062 Wire Wrap	W4							
																						Rocker Actuator ⑨	J71									
																						Paddle Actuator ⑨	J72	Solder Lugs	Z							
																						Rocker Actuator ⑨	J73	Quick Connect	Z3							
					Paddle Actuator ⑨	J75																										
					Rocker Actuator ⑨	J76																										
					Paddle Actuator ⑨	J77																										

*Momentary Contact

- ① 1 and 2 pole only.
- ② For J50 and J60 only.
- ③ For J11, J21, J37 and J47 only.
- ④ Consult plant for availability.
- ⑤ These circuits are NOT available with the following 3 and 4 pole options: A, AV1, AV2, V3, V4, V5, V6 and V7.
- ⑥ Epoxy seal standard on all terminal options.

- ⑦ Available with C, Z, Z3 or W-W4 terminations.
- ⑧ Available with AV1, AV2, V3-V7 terminations.
- ⑨ Available with A, AV1, AV2 or V3-V7 terminations.
- ⑩ 1, 2 and 3 pole only.
- ⑪ See page 58 for construction detail, wiring and electrical diagrams.
- ⑫ Same as B, G and Q respectively except terminals brass with tin nickel alloy over nickel plate. Consult plant for availability.

EXAMPLES:

- B121J71AQ2 =** SPDT rocker switch with an ON-OFF-ON circuit, J71 style rocker (black), right angle P.C. terminals with coin silver contacts and epoxy sealed terminals.
- B223J50ZQ22P =** DPDT rocker switch with an ON-NONE-ON circuit, J50 style rocker (black), solder lug terminals with coin silver contacts, black snap in bezel and epoxy sealed terminals.

Standard Rocker & Paddle Switches — Specifications and Materials

SPECIFICATIONS

Contact Rating — Letter codes G and Q — 6 amp at 125 VAC, 3 amp @ 250 VAC, (U.L. recognized, CSA certified) or 6 amp at 28 VDC resistive.

Letter codes B and G — 0.5. volt-amp (VA) maximum @ 28 V maximum (AC or DC).

Life Under Load — 60,000 make-and-break cycles — resistive load only.

Initial Contact Resistance — 10 milliohms maximum. 3 VDC, 100 ma for both silver and gold plated contacts.

Insulation Resistance — 1 & 2 pole — 1,000 megohms minimum.
3 & 4 pole — 1,000 megohms minimum.

Dielectric Strength — 1,000 volts rms at sea level.

Operating Temperature — 30° to +85°C

MATERIALS

Base (body) — 1- and 2-pole — Diallyl Phthalate. (DAP).
3- and 4-pole — high strength phenolic.

Rocker/Paddle — Molded nylon.

Bushing — Brass, nickel plated.

Clamp (frame) — Stainless steel.

Support Bracket — Steel, tin plated.

Metal Bezel — Spring steel.

Plastic Bezel — Molded nylon.

Switching Contacts and Rockers —

Letter Code B — gold/nickel/brass

Letter Code G — gold/nickel/silver

Letter Code Q — Coin silver

Center Terminal

Letter Codes B, G — Gold flash/nickel/brass

Letter Code Q — Silver plated brass.

Hardware — See page 57.

APPROXIMATE BASE DIMENSIONS



Rocker Actuator Options For P.C. Mounting

<p>J71</p>	<p>J72</p>
<p>J73</p>	<p>J75</p>
<p>J76</p>	<p>J77</p>

ACTUATOR/MOUNTING OPTIONS

<p>J1 Screw Mount Rocker</p>	<p>Refer to Page 57 for Mounting Hardware</p>
<p>J2 Screw Mount Paddle Rocker</p>	<p>Refer to Page 57 for Mounting Hardware</p>
<p>J3 Screw Mount Large Rocker</p>	<p>Refer to Page 57 for Mounting Information</p>
<p>J5 Screw Mount Large Tapered Paddle Rocker</p>	<p>Refer to Page 57 for Mounting Hardware</p>

Actuator and Mounting Options — Cont'd

J11 Rocker with Snap-In Bezel ①



J21 Paddle with Snap-In Bezel ①

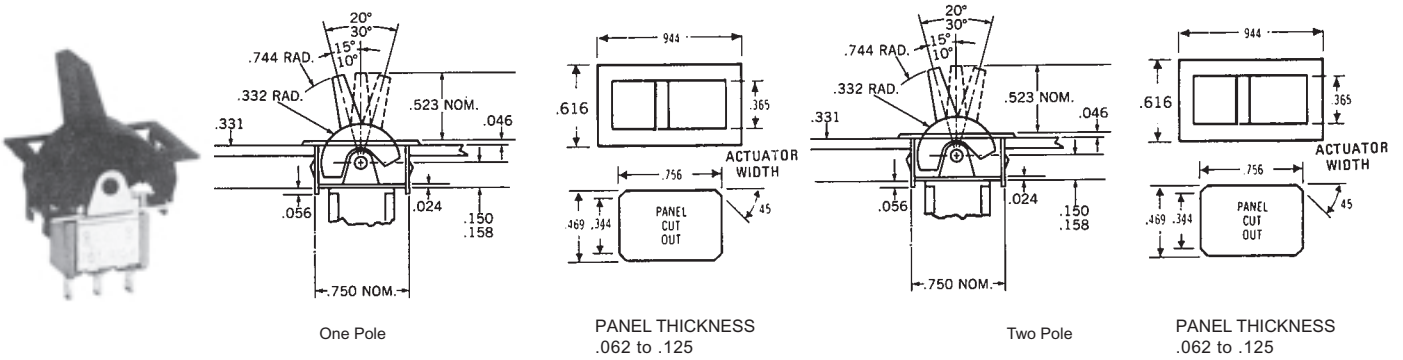

J37 Rocker Actuator/Mounting Option



J47 Paddle Actuator/Mounting Option



① Three and four pole switches require assembly from back of panel.

Actuator and Mounting Options

J50 = Snap in Mounting w/Low Profile Rocker ①
J60 = Snap in Mounting w/Low Profile Paddle

J50 Rocker Style **J60** Paddle Style

PANEL CUT-OUT

J53 = Snap in Mounting w/High Profile Rocker ①
J63 = Snap in Mounting w/High Profile Paddle

J53 Rocker Style **J63** Paddle Style

PANEL CUT-OUT

OPTIONAL BEZELS (For use with J50/J60 Series only)

Bezel Assembled with J50/J60 Series

J50 Rocker Style w/Bezel **J60** Paddle Style w/Bezel

PANEL CUT-OUT

Color	Code	Part No.
White	1P	W-BZ-12A
Black	2P	W-BZ-12
Red	3P	W-BZ-12B

Bezel for L.E.D. Assembled with J50/J60 Series (Note: LED is not supplied)

J50 Rocker Style w/Bezel for L.E.D. **J60** Paddle Style w/Bezel for L.E.D.

PANEL CUT-OUT

Color	Code	Part No.
Black	4P	W-BZ-15

OPTIONAL MOUNTING CLIP (For use with J50/J60 Series only)

Clip Assembled with J50/J60 Series

PANEL CUT-OUT

- For thick plastic panel mount applications (.094" - .125" thick)
- Consult factory for availability

① All rocker switches on this page are snap-in from the front of the panel. No behind panel assembly hardware is needed.



TERMINATION/MOUNTING OPTIONS

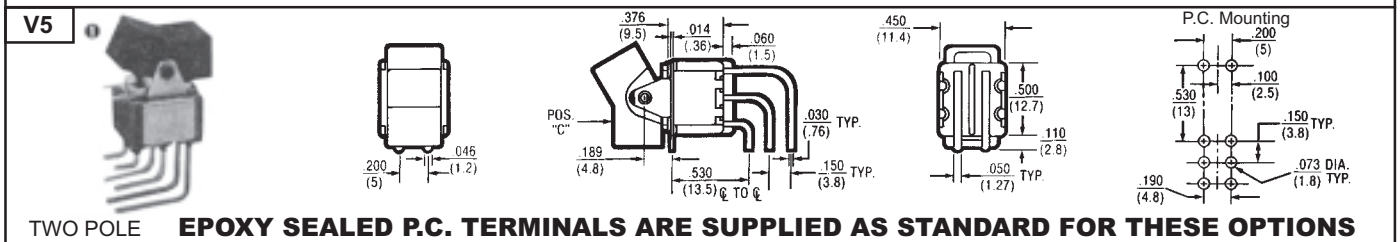
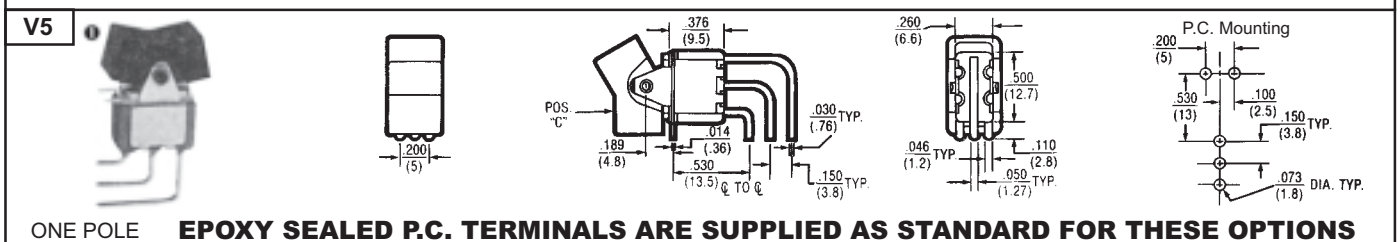
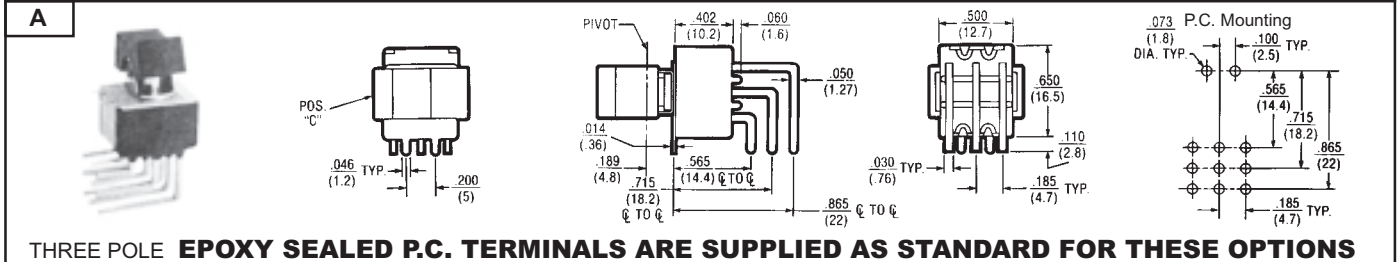
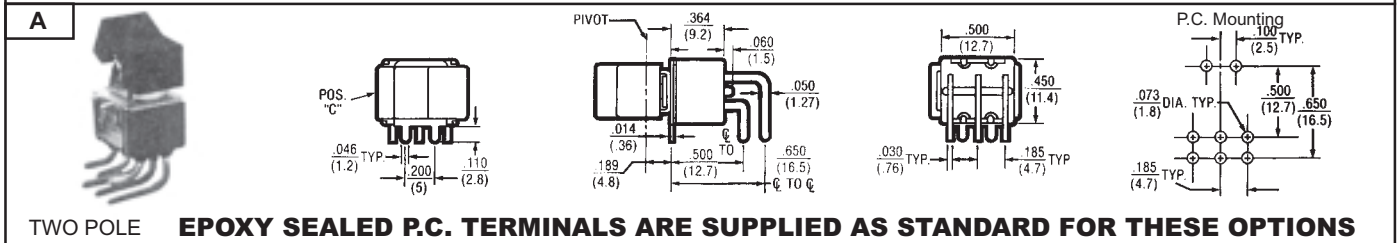
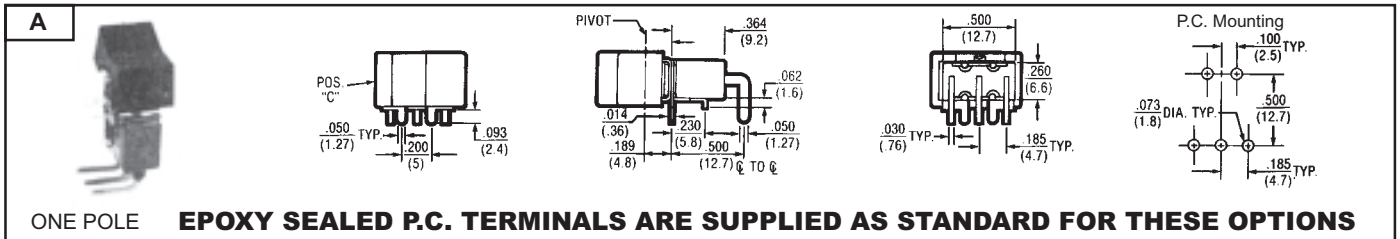

① The V5 option is available in Three and Four Pole Circuits.

Termination/Mounting Options

AV1 w/.100" Terminal Spacing
AV2 w/.150" Terminal Spacing (Pictured Below)

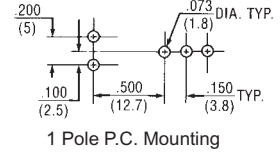
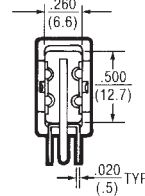
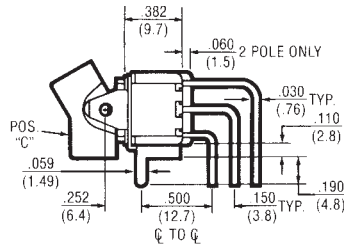
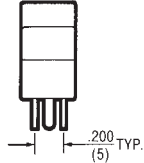
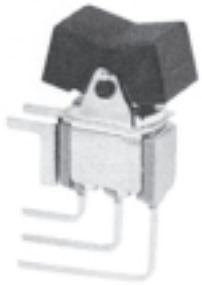

ONE POLE **EPOXY SEALED P.C. TERMINALS ARE SUPPLIED AS STANDARD FOR THESE OPTIONS**

AV1 w/.100" Terminal Spacing
AV2 w/.150" Terminal Spacing (Pictured Below)

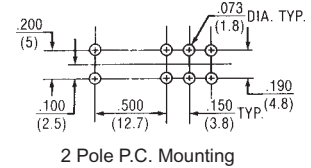
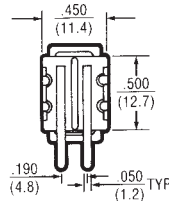
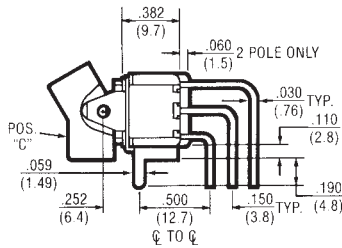
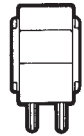

TWO POLE **EPOXY SEALED P.C. TERMINALS ARE SUPPLIED AS STANDARD FOR THESE OPTIONS**

AV1 w/.100" Terminal Spacing
AV2 w/.150" Terminal Spacing (Pictured Below)

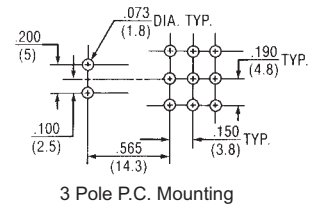
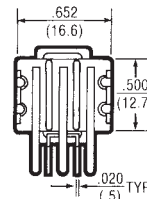
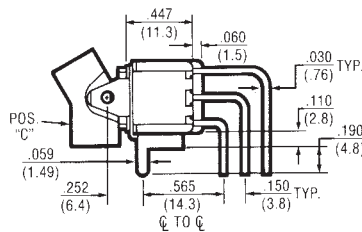
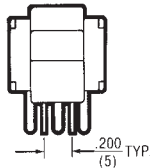

THREE POLE **EPOXY SEALED P.C. TERMINALS ARE SUPPLIED AS STANDARD FOR THESE OPTIONS**

AV1 w/.100" Terminal Spacing
AV2 w/.150" Terminal Spacing (Pictured Below)

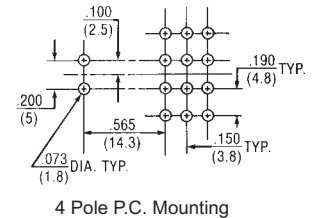
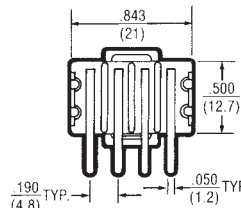
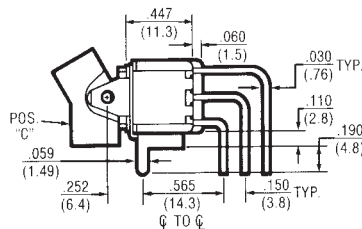
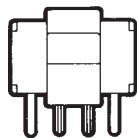

FOUR POLE **EPOXY SEALED P.C. TERMINALS ARE SUPPLIED AS STANDARD FOR THESE OPTIONS**

V3

1 Pole P.C. Mounting
2 Pole P.C. Mounting

EPOXY SEALED P.C. TERMINALS ARE SUPPLIED AS STANDARD FOR THESE OPTIONS

V4

1 Pole P.C. Mounting
2 Pole P.C. Mounting

EPOXY SEALED P.C. TERMINALS ARE SUPPLIED AS STANDARD FOR THESE OPTIONS

V6

1 Pole P.C. Mounting
2 Pole P.C. Mounting

EPOXY SEALED P.C. TERMINALS ARE SUPPLIED AS STANDARD FOR THESE OPTIONS

V7

1 Pole P.C. Mounting
2 Pole P.C. Mounting

EPOXY SEALED P.C. TERMINALS ARE SUPPLIED AS STANDARD FOR THESE OPTIONS



Компания «ЭлектроПласт» предлагает заключение долгосрочных отношений при поставках импортных электронных компонентов на взаимовыгодных условиях!

Наши преимущества:

- Оперативные поставки широкого спектра электронных компонентов отечественного и импортного производства напрямую от производителей и с крупнейших мировых складов;
- Поставка более 17-ти миллионов наименований электронных компонентов;
- Поставка сложных, дефицитных, либо снятых с производства позиций;
- Оперативные сроки поставки под заказ (от 5 рабочих дней);
- Экспресс доставка в любую точку России;
- Техническая поддержка проекта, помощь в подборе аналогов, поставка прототипов;
- Система менеджмента качества сертифицирована по Международному стандарту ISO 9001;
- Лицензия ФСБ на осуществление работ с использованием сведений, составляющих государственную тайну;
- Поставка специализированных компонентов (Xilinx, Altera, Analog Devices, Intersil, Interpoint, Microsemi, Aeroflex, Peregrine, Syfer, Eurofarad, Texas Instrument, Miteq, Cobham, E2V, MA-COM, Hittite, Mini-Circuits, General Dynamics и др.);

Помимо этого, одним из направлений компании «ЭлектроПласт» является направление «Источники питания». Мы предлагаем Вам помощь Конструкторского отдела:

- Подбор оптимального решения, техническое обоснование при выборе компонента;
- Подбор аналогов;
- Консультации по применению компонента;
- Поставка образцов и прототипов;
- Техническая поддержка проекта;
- Защита от снятия компонента с производства.



Как с нами связаться

Телефон: 8 (812) 309 58 32 (многоканальный)

Факс: 8 (812) 320-02-42

Электронная почта: org@eplast1.ru

Адрес: 198099, г. Санкт-Петербург, ул. Калинина, дом 2, корпус 4, литера А.