



■ Renewable energies



■ Water treatment



■ Industrial machines



[www.millenium3.crouzet.com](http://www.millenium3.crouzet.com)

## ***Millenium**3 Standard & Custom*

**The right solution - whatever the application!**

# Millenium3

With Millenium 3...

The right solution - whatever the application!



■ Millenium 3 Standard  
"Compact range"



■ Millenium 3 Standard  
"Expandable range"



■ Millenium 3 Standard  
"Communication range"



■ New features  
"Millenium 3 Standard"



■ New features  
"Millenium 3 Custom"

## Our company at a glance



Always one step ahead of market trends and customer requirements, Crouzet is continually developing its range of both standard and customised automation components and solutions to cover all the latest commercial and industrial applications and meet the needs expressed by manufacturers of automated equipment and machinery.

Headquartered in Moorpark, California-USA, Custom Sensors & Technologies (CST) is made up of the leading brands of Crouzet, Kavlico and Crydom, as well as the former divisions of BEI Technologies, including Newall and Systron Donner. CST provides sensors, controls, and actuation products to the transportation, industrial, and aerospace & defense markets. This new organization means even better service and technical solutions for our customers.

With Micro-control, Crouzet is a specialist provider of complete solutions tailored to meet your needs in terms of:

- Time management
- Management of physical and electrical values
- Counting

The entire range is marketed through a global distribution network working hand in hand with local sales forces dedicated to Micro-control applications.

## 3rd generation of logic controllers at the core of your industry.

With the new Millenium 3, you can take advantage of all the most recent developments in the latest generation of logic controllers. An innovative product, developed, industrialised and marketed by Crouzet, Millenium 3 is the successful synthesis of our expertise in automation systems acquired over a period of more than 40 years.

With the aim of matching your applications even more closely, Crouzet is expanding its **Millenium 3 Standard** logic controller offer which was originally launched in 2006:





- New software functions (sunrise/sunset, etc.)
- New accessories (pressure control solution, levels, flow, broader range of power supplies, remote display/keypad, improved communication extension performance, etc.)

In addition to its **Millenium 3 Standard** logic controllers for today's automation needs, Crouzet is also able to offer its **Millenium 3 Custom** logic controllers for specific applications (water treatment, geothermal systems, etc.), or for use in severe environments.

Whatever the application, Crouzet is able to offer you bespoke products that work in complete harmony with your equipment.



# Contents

	<b>What is a logic controller used for?</b>	p. 4-7
	<b>Millenium 3 Standard</b>	
	<b>Presentation of the offer</b>	
■	Overview of product offer	p. 8-13
■	Introduction to programming software	p. 14-19
■	Examples of application areas with focus on compressor management	p. 20-21
	<b>Catalogue pages</b>	
■	General characteristics	p. 22-25
■	“Compact” range selection guide	p. 26-27
-	“Compact” range CD12-CD20 with display	p. 28
-	“Compact” range CB12-CB20 without display	p. 29
■	“Expandable” range selection guide	p. 30-31
-	“Expandable” range XD10-XD26 with display	p. 32
-	“Expandable” range XB10-XB26 without display	p. 33
-	“Expandable” range/communication “Sandwich” extensions XN03 - XN05 - XN06	p. 34
-	“Expandable” range/digital “Sandwich” extensions XE10	p. 35
-	“Expandable” range/digital termination extensions XR06-XR10-XR14	p. 36
-	“Expandable” range/analogue termination extensions XA04	p. 37
■	<b>Plug &amp; Play solutions</b> for STN and GSM modem communication	p. 38-39
■	I/O wiring and installation diagrams	p. 40-43
	<b>Accessories by function</b>	
■	<b>Programming</b>	p. 44
■	<b>Installing</b>	p. 45
■	<b>Displaying</b>	p. 46-49
■	<b>Converting</b>	p. 50-51
■	<b>Sensing</b>	p. 52-56
■	<b>Power supplies</b>	p. 57-61
	<b>Millenium 3 Custom</b>	
	<b>Presentation of the offer and adaptation capability</b>	
■	Introduction to the Customer Adaptation Technical Service	p. 62-63
■	Hardware adaptation capability	p. 64-65
■	Software adaptation capability	p. 66-67
■	Examples of application solutions	p. 68-69
	<b>Catalogue pages</b>	
■	Kitting	p. 70
■	“Bare board” versions NB12 - NB20	p. 71
■	“Modular” versions CD12 - CB12 - CB20 - XD10 - XB10 - XD26 - XB26	p. 72-73
■	“Resin board” versions NBR12 - NBR26 - NBR32 - NBR40	p. 74-75
■	“Application” specific analogue extensions XA03 - XA04W	p. 76-77
■	pH and ORP probes	p. 78
■	NTC probe	p. 79
■	I/O wiring and installation diagrams	p. 80-81
	<b>General information Millenium 3</b>	
■	Introduction to the website	p. 82-83
■	Customer project sheet	p. 84-85
■	How to order	p. 86
■	Part numbers index	p. 87-91

# Millenium3



## ■ Fountain

Pump control with variable flow for different water jet and mood effects, regulation of water neutrality (pH) and disinfecting of water in fountain (ORP).



## ■ Field irrigation

Irrigation control based on temperature, humidity, and day/night cycle.



## ■ Hydraulic solar heating

Automation of operation and heating regulation plus remote management of the installation via GSM modem.



## ■ Opening control for industrial sectional doors

Opening control for doors and associated security devices for restricting access. Synchronisation between the various doors.

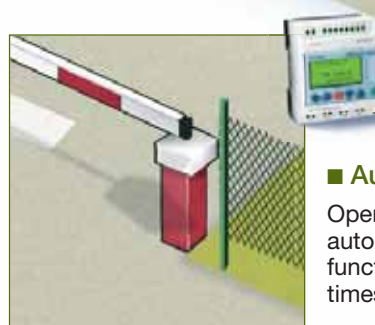

## ■ Automatic barrier

Opening control of barriers with automatic vehicle detection and function for selecting opening times/days.

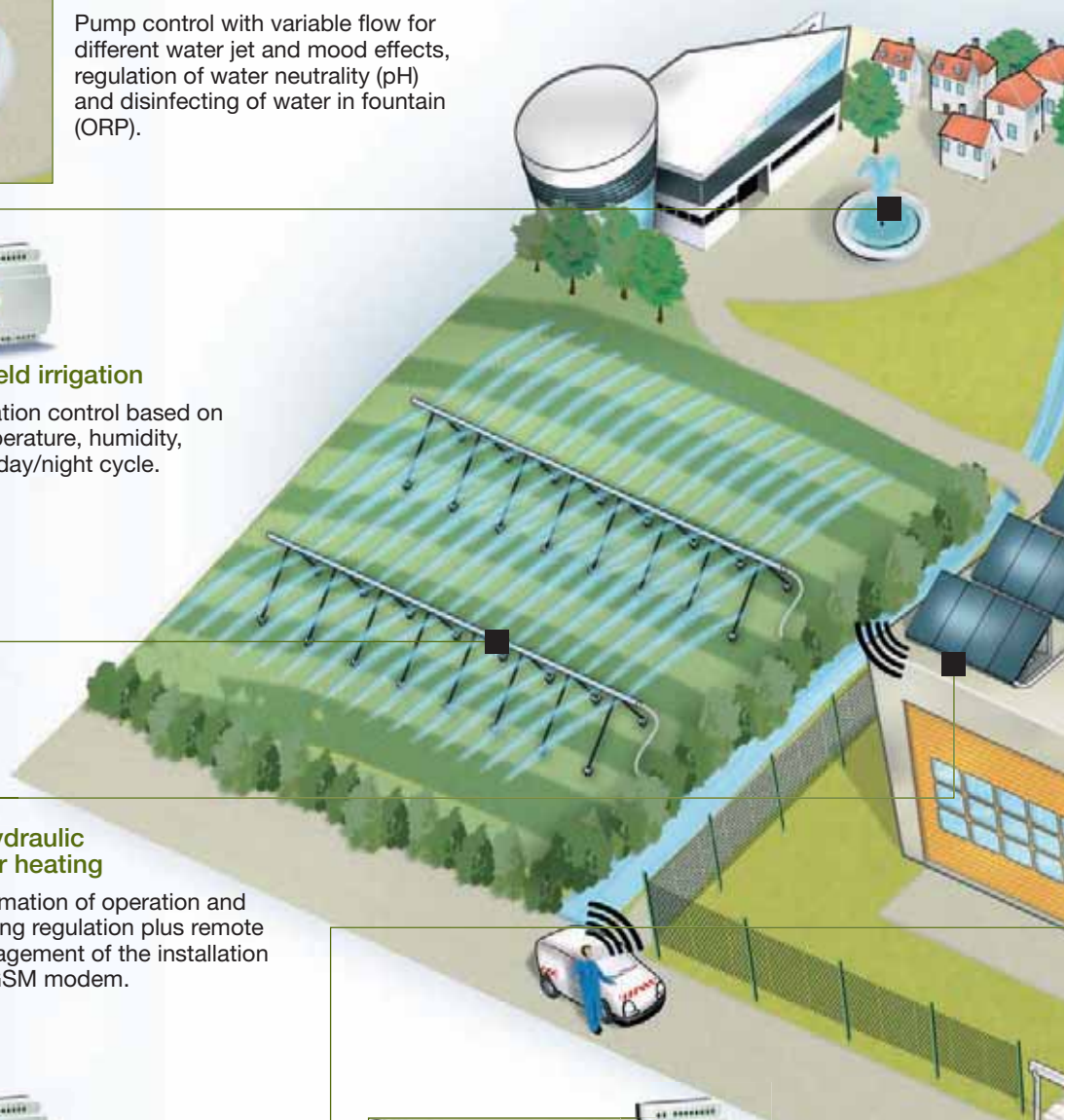

# What is a **logic controller** used for?

The Millennium 3 logic controller can be used to automate small devices requiring between 10 and 50 I/O. Millennium 3's logic functions can be used in numerous applications, including packing, access control, vending, irrigation, pump management and HVAC control.

Millennium 3 is available in a "Compact" version for simple automation systems or an "Expandable" version for enhanced performance. There are also "Resin" or "Bare board" versions available for special applications.

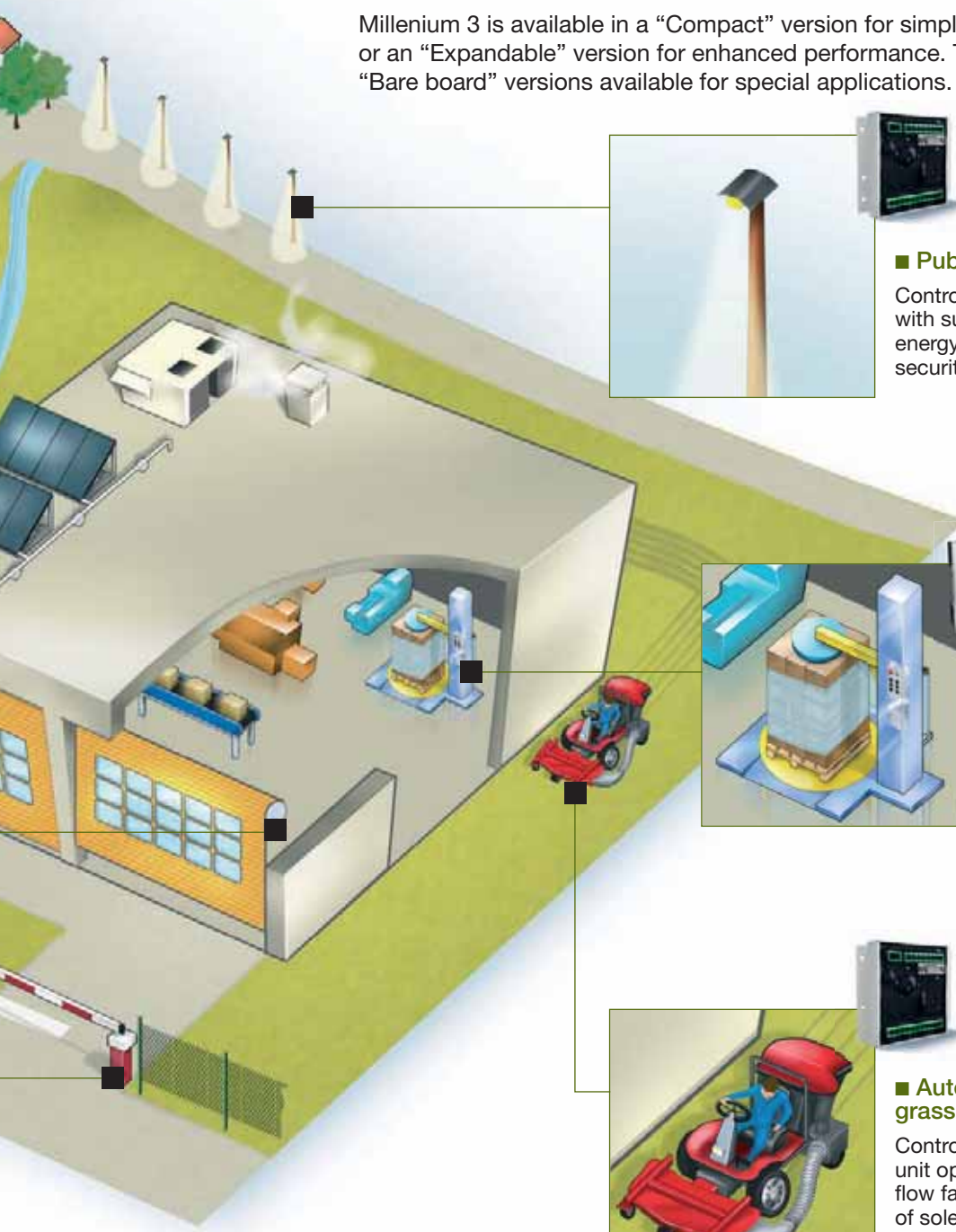

### ■ Public lighting

Control of public lighting to coincide with sunrise/sunset in order to save energy whilst ensuring optimum security levels.



### ■ Stretch wrapping machine

Controls the motor that unrolls the packing film, controls cutting of the film after heat sealing, and determines the duration of the motor cycles.



### ■ Automation of industrial on-board grass-cutter

Control of machine automation and cutting unit operating conditions: control of reverse flow fan (filter cleaning function), control of solenoid valves for locking rear wheels in a straight line, control of cylinders/start function/lights/horn.

# Millenium3

## More possibilities



■ Supplying power



■ Sensing



■ Operator dialogue



■ Communicating



■ Actuating

### PROCESSING

#### Millenium 3 functions

- **Timing:** 5 types of timer
- **Counting:** 3 types of counter
- **Regulating:** Hysteresis cycle, PID, etc.
- **Archiving/saving:** 10-year data backup function, even after a power failure
- **Calculating:** Maths functions
- **Logic operations:** AND, OR, NAND, NOR, XOR, NOT, etc.
- **Creating sequential programs:** Grafset, cam timer, etc.
- **Triggering events:** Year, month, day, hour, minute, etc.

The inputs (digital, potentiometer or 10-bit analogue) of the Millenium 3 logic controller are compatible with most sensors on the market: temperature sensors, pressure transmitters, level detectors, flow sensors, etc.

### Sensing

#### Supplying power

12 and 24 V DC voltages available.  
Several power supply ranges from 7.5 to 240 W.



#### Operator dialogue

To make it easier for the operator during parameter setting or operation, Millenium 3 has a built-in, backlit screen (4 lines of 18 characters, drop-down screen, bar chart).

It is equally possible to use the remote LED screen (via Modbus extension XN06) or the LCD screen.

**NEW** Backlit LCD screen/keypad with 4 lines of 18 characters and featuring 6 keys or 10 keys with 4 LEDs (direct communication with the Millenium 3 via the programming port).

# What is a **logic controller** used for?

## **Adjusting**

There are several options for adjusting setpoints, including an external control potentiometer on the analogue inputs and internal setpoints modifiable via the display.

## **Converting**

Analogue extensions are used to acquire or provide current, voltage or temperature values and convert them to the digital signals needed by the logic controller.

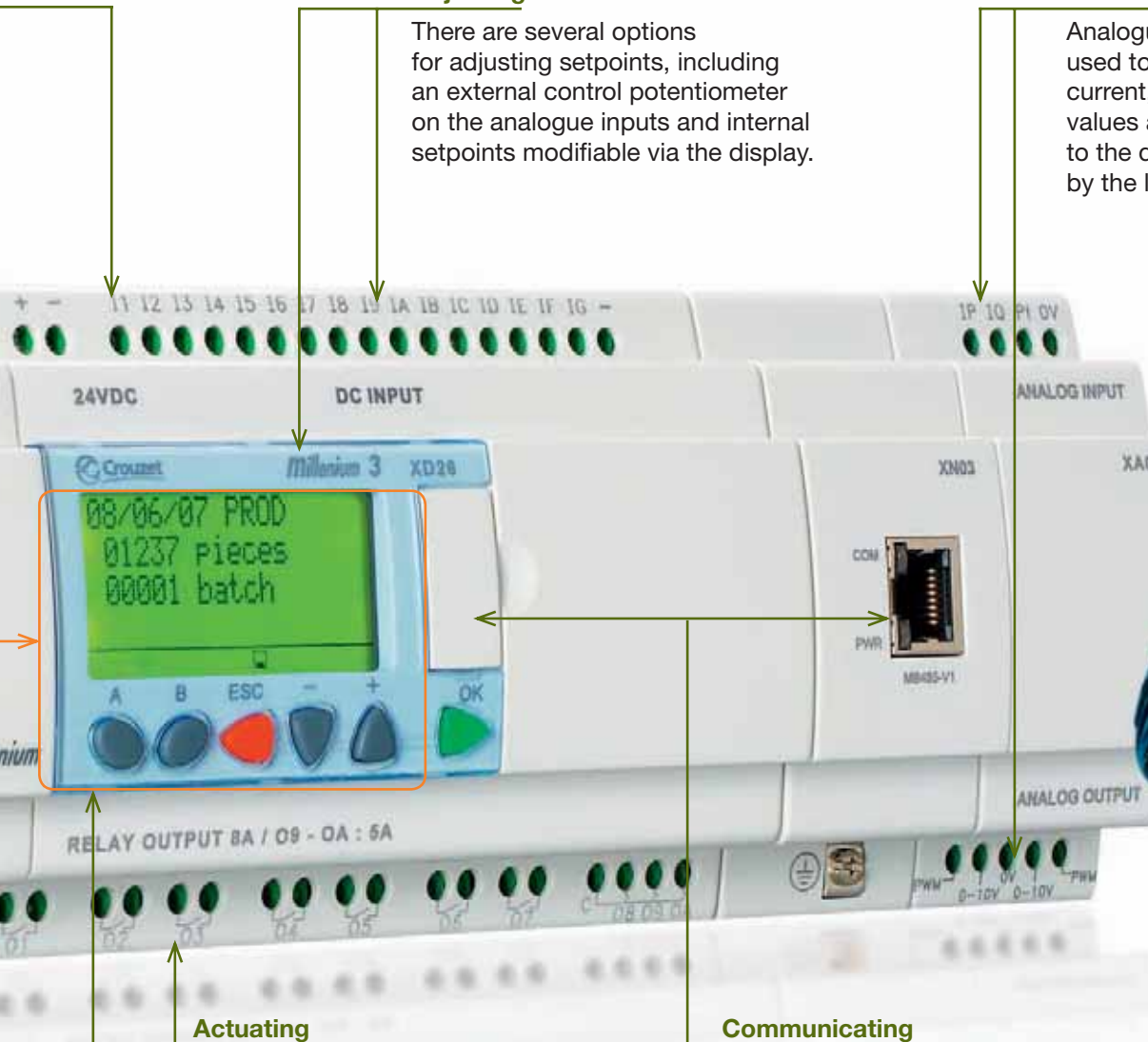

## **Actuating**

Millenium 3 can be used to drive devices such as brushless motors, solenoid valves and pumps (relay, solid state or PWM outputs).

## **Communicating**

Millenium 3 offers the option of supervising and connecting your devices (PC, remote screens/ keyboards, etc.) by linking the logic controllers to fieldbuses (Modbus, Ethernet) or via a modem: STN or GSM.

# Millenium3



## The benefits of the new range



■ Modularity



■ Optimised wiring time



■ Ergonomic display



■ Mounting on DIN rail or using screws



■ Networked offer

## ▶ Millenium 3 “Compact” range

■ With display

■ Without display



CD12



CD20



CB12



CB20

## ▶ Millenium 3 “Expandable” range

■ With display

■ Without display **NEW**



XD10



XD26



XB10



XB26

## ▶ Millenium 3 communication solutions

■ Plug & Play solutions for modem communication

■ Communication extensions for 24 V DC expandable controller



STN

GSM

M3MOD



XN03

4-word Modbus extension

XN05

Ethernet extension

XN06

8-word Modbus extension

**NEW**



# Product offer overview



“Compact range” starter kits with display

## ■ Digital “Sandwich” extension



XE10

## ■ Digital extensions



XR06



XR10



XR14

## ■ Analogue extension



XA04



“Expandable range” starter kits with display

See page 76 for other analogue “application” extensions.

If you have specific needs, see page 62.

“ Millenium 3 is a very rational range, offering a high degree of consistency and true continuity over time. It's particularly useful when you have equipment life cycles lasting several years.

Mickaël, Technical Director



# Millenium3



More configuration options

Find the best solution to meet your needs,

[Overview of Millenium 3 Combinations](#)

You need:

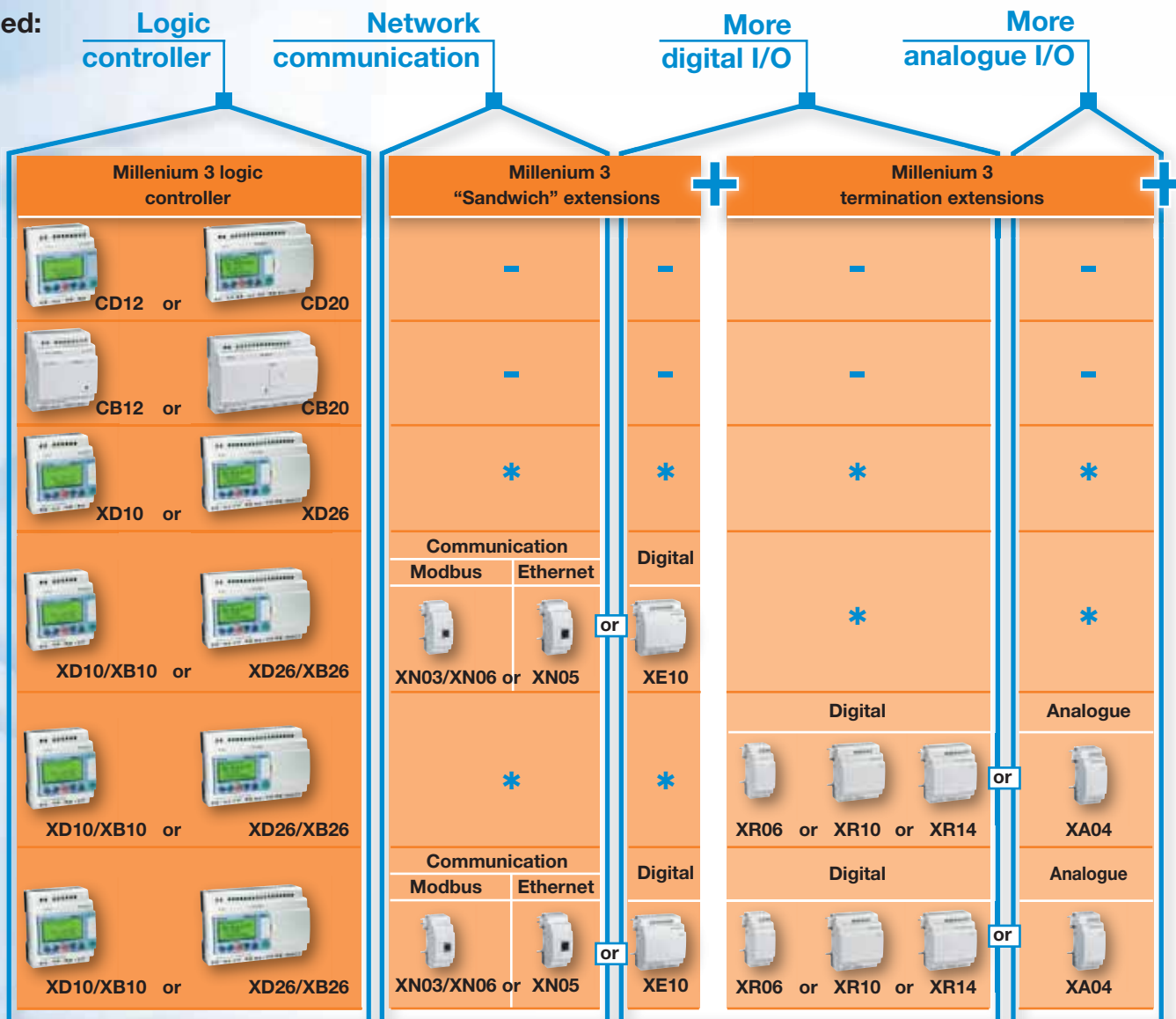

■ Example Millenium 3 combination: XD26 + XE10 + XR14



# Product offer overview

all thanks to the modularity of Millenium 3.

## Modem communication

Plug & Play solutions for modem communication



Compatible with M3MOD + GSM/STN modem

Number of I/O available								
CD12 only				or	CD20 only			
12					20			
CB12 only				or	CB20 only			
12					20			
XD10/XB10 only				or	XD26/XB26 only			
10					26			
XD10/XB10 with					XD26/XB26 with			
XE10	XN03	XN05	XN06	XE10	XN03	XN05	XN06	
20	10	10	10	36	26	26	26	
XD10/XB10 with					XD26/XB26 with			
XR06	XR10	XR14	XA04	XR06	XR10	XR14	XA04	
16	20	24	14	32	36	40	30	
XD10/XB10 with					XD26/XB26 with			
XN, XE, XR or XA					XN, XE, XR or XA			
20 to 34					36 to 50			

NB: For voltage selection, see pages 26-27 and 30-31.

■ : Extension not compatible

\* : Not used

“ With Millenium 3, I buy what I actually need!

No matter what specification the technical team draws up in terms of I/O or supply voltage for example, I can find the right product in the Millenium 3 range.

As a result, thanks to this modularity, I always get the best cost-effectiveness ratio.

Catherine, Automation Component Purchasing Manager



Millenium 3 Standard





## For greater efficiency



■ Sprinklers



■ Drink vending machines



■ Telemaintenance for a pumping station



■ Sliding gate

## ▶ Plug & Play solutions for modem communication

### With the networked logic controller, you can control your installations remotely.

Using the M3MOD communication interface, you can monitor and control your installations remotely while reducing your maintenance costs:

- Perform pre-diagnostics.
- Avoid pointless visits.
- Define priorities before responding.

**The M3MOD interface** can be used with two 2 modems - the **STN** modem for wired networks or the **GSM** modem for wireless communication.

#### On site with a mobile phone:

- Receive SMS alerts containing up to 160 characters and able to include a digital and/or analogue value: if one mobile phone is unavailable, the alarm is automatically redirected to another mobile phone.
- Send commands to a remote Millenium 3 logic controller (you control Millenium 3 outputs remotely).
- Interrogate the status of application components and remotely modify the digital and/or analogue value of a program component.

#### In the office with the M3 ALARM software:

- Take advantage of the same functions as on your mobile phone with all the comfort of a PC environment.
- Manage the composition of your maintenance teams.
- Organise your alarms easily so that you can file, archive, sort or export them.



■ GSM modem communication solution

# Product offer overview

## ► Overview of other Millenium 3 communication solutions

### Easy-to-use, high-performance tools able to communicate with new forms of technology

#### Millenium Web Server, the Embedded Web SCADA solution:

(Part no.: 88950124)

- Remote supervision and monitoring from any system with an Internet browser (PC, mobile telephone, PDA, etc.)
- Intuitive programming of supervision pages without the need for prior knowledge of programming languages
- Automatic generation of supervision web pages (up to 20 pages)
- Automatic alerts by e-mail/SMS/fax regarding any change in monitored status
- Fieldbus management (Modbus master)
- Analogue (temperatures, etc.) or digital (alarms, etc.) data archiving, with text-based data evaluation using spreadsheets

*For more information on this Embedded Web supervision solution, please visit the dedicated website:  
[www.webserver.crouzet.com](http://www.webserver.crouzet.com)*

#### Other communication options:

- Ethernet (Modbus TCP protocol) and Modbus slave extensions with up to:
  - 8 input data words (read/write)
  - 8 output data words (read)
- Programming via serial cable, USB, Bluetooth interface, memory card or modem



■ Millenium Web Server



■ Communication extensions



■ Programming accessories

“ In the case of extremely remote equipment, the fact that we can access the Millenium 3 controller remotely means we can optimise our response times. And the wireless link is a real bonus when it comes to controlling the automatic gates we have installed!

Roberto, Operations Maintenance Manager ”





## 6 steps to greater simplicity

### Example of programming in FBD/Grafcet SFC

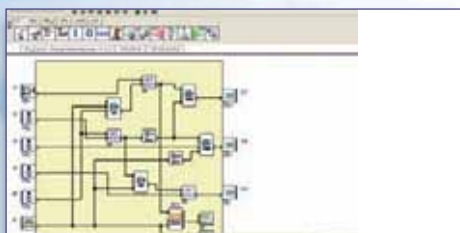

#### ■ Creating



#### ■ Simulating

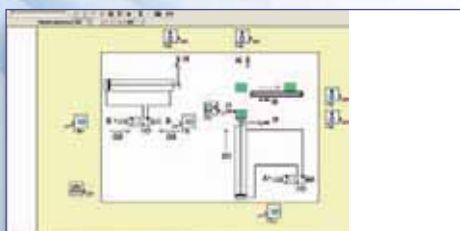

#### ■ Supervising

## Two programming languages

### With Millenium 3, programming mirrors how you work.

Whether you are an electrical engineer or a control systems engineer, you can select the programming language you prefer. With **Ladder or FBD/Grafcet language**, everything is intuitive, quick and safe.

Millenium 3 is capable of reading and converting programs created on the Millenium 2 logic controller.

For quick, simple programming, the Millenium 3 software prioritises **dedicated application-specific functions** such as pump switching, PID control, movement, pressure, level and flow.

All the basic functions, such as counting, timing, comparison and display, are also available.

The **M3 SOFT** programming software incorporates error checking, so that when the slightest data entry error is made, it flags the incorrect item in red.

The **M3 SOFT** software is multilingual, offering English, French, Italian, German and Spanish.

#### ■ Programming

You can choose between two different languages: **Ladder and FBD/Grafcet**.

#### ■ Creation

You can select the physical or internal I/O and the **preprogrammed functions** you need for your application.

#### ■ Simulation

You can test the result of your programming in real time.

#### ■ Downloading

You can transfer your programs directly to the controllers using local wired or wireless (**Bluetooth**) equipment or transfer them remotely using **modem solutions**.

#### ■ Supervision

You can view the status of your application, locally or remotely, thanks to the communication solutions.

#### ■ Development

You can develop your program to keep pace with modifications to your installation.

# Introduction to **programming** software

## ▶ **Software innovations** for easier programming

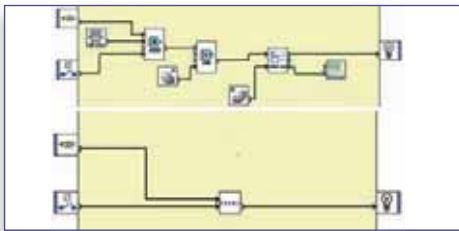

■ **Macro function**

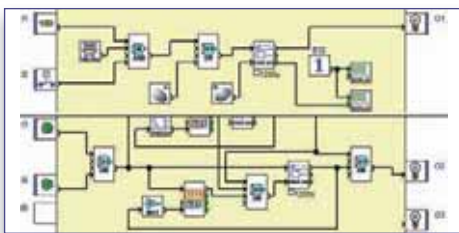

■ **Division of screen**

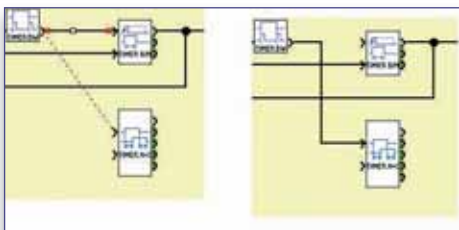

■ **Moveable links**

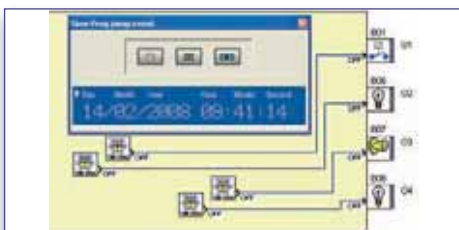

■ **Time simulator**

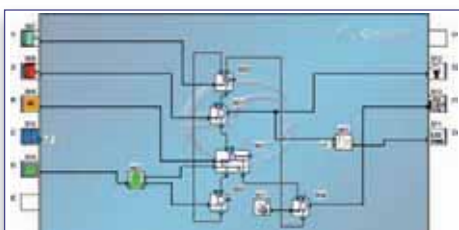

■ **Visual customisation**

### ■ **Macro function**

Integrating your repetitive functions into dedicated macro functions saves time and makes your life easier, as it enables you to reuse your expertise directly within your programs. You can access and modify the content of your macro functions, or choose to protect them with a password.

### ■ **Division of the wiring sheet into several edit windows**

This kind of division makes it possible to display two different sections of the wiring sheet on the same screen. This makes it easier to carry out debugging and wiring for your program.

### ■ **Easy moving of links**

The fact that you can move the links means you can develop your program by replacing function blocks but without losing your existing links.

### ■ **Simulating program timing**

The “Next event” key enables the user to set the time of the time simulator to the start of next timed event that has been programmed.

### ■ **Customising your program with your own images**

The software enables you to import images into your program so you can customise your wiring sheet, your input/output icons and your macro functions.



## Programming that is even more natural



## FBD/Grafcet SFC language

With the M3 SOFT CD-ROM, you can take advantage of unrivalled programming flexibility and a huge processing capacity (up to 700 function blocks).

### ■ 27 preprogrammed FBD functions

#### ■ Timing/clock



##### TIMERS

**A/C function:** Delay on and off

**BW function:** Pulse on a rising or falling edge

**B/H function:** Adjustable pulsed signal

**Li/L function:** Pulse generator (ON/OFF setting)

##### Totalizer function

When these functions have preset parameters, they can be adjusted in real time from an external setpoint.



##### PRESET H-METER

Preset hour counter (preselection of hour, minute).



##### TIME PROG

Daily, weekly, monthly and yearly time programmer.

#### ■ Counting



##### UP/DOWN COUNT

External preset up/down counter.



##### PRESET COUNT

Preset up/down counter.

#### ■ Logic processing



##### BISTABLE

Impulse relay function.



##### SET - RESET

Bistable memory - Priority assigned to either SET or RESET.



##### BOOLEAN

Creation of logic equations between connected inputs.



##### CAM TIMER

Controls a group of 8 integral cam wheels.

#### ■ Digital processing



##### ADD-SUB

Simple operations on integers: Addition and/or Subtraction.



##### DEC/BIN

Breaks down an integer type input (16 bits) into 16 bit type outputs.



##### ARCHIVE

Used to save two values simultaneously with the information relating to their time-stamping.



##### MUL-DIV

Simple operations on integers: Multiplication and/or Division.



##### BIN/DEC

Makes up an integer type output (16 bits) from 16 bit type inputs.



##### MUX

Multiplexing function on 2 analogue values.



##### GAIN

Used to convert an analogue value by changing the scale and offset.

#### ■ Detection



##### COMPARE IN ZONE

Used to compare a value between two setpoints (the MIN and MAX values determine the zone).



##### SCHMITT TRIGGER

Used to monitor an analogue value in relation to two thresholds.



##### STATUS

Allows the user to access the controller states and modify the behaviour of its FBD and/or SFC program depending on these states.



##### COMPARE

Used to compare two analogue values using the =, >, <, ≥, ≤, ≠ operators.



##### MIN MAX

Used to save the minimum and maximum values of a variable signal.

#### ■ Display



##### DISPLAY ON THE LCD SCREEN

Display of digital and analogue data, date, time, messages for human-machine interface (Bar chart function available).



##### TEXT

Display of a page of text and/or numerical values (current value, preset value, etc.) on the LCD display.



##### STANDARD MACRO

Used to obtain examples of preprogrammed macros for scrolling 4 or 15 "DISPLAYS". These examples can be modified and configured with different parameters.



# Introduction to programming software

## ■ Communication



### SLIN (SERIAL LINK INPUT)

Writing via serial link of data stored in the controller's fixed addresses.



### SLOUT (SERIAL LINK OUTPUT)

Reading via programming port of data stored in the controller's fixed addresses.



### MESSAGE

When activated, the Message function block can be used to:

- send alarm messages to mobile phones, to the Millenium 3 Alarm tool or to e-mail addresses via the M3MOD communication interface.
- provide remote access to a digital variable and/or a numerical variable, in order to read or modify them.

## ■ 20 specific preprogrammed FBDC functions

In addition to the basic function blocks, **Crouzet's M3 SOFT CD-ROM (Part no. 88970111)** also contains a library with specific functions adapted to your requirements and your application (water management, HVAC, etc.).

## ■ Timing/clock



### NEW HOUR/MINUTE

Provides the time from the controller (hour and minutes).



### NEW TIMER SET RESET SWITCHING

Triggers operation of a particular device at a fixed time for a period set by the user.



### NEW SUNRISE/SUNSET TIME

Calculates the sunrise and sunset time in relation to the latitude and longitude read on the function block inputs. It is used to generate high levels on these "Morning Pulse" and "Evening Pulse" outputs according to the user parameters.

## ■ Counting



### FAST COUNT

Counts the pulses arriving at the input at rates in excess of one pulse every 10 ms.



### HIGH SPEED COUNT

Counts the pulses arriving at the inputs of a controller powered by a DC supply at rates in excess of one pulse every 6 ms.

## ■ Digital processing



### ARCHIVE

Saves a value between -32768 and 32767.



### STORE

Storage of data values with an average value.



### DEM (DEMULTIPLEXER)

Demultiplexing of integers. Used to direct the value of the input to one of the 4 OUTPUTS.



### MUX (MULTIPLEXER)

Multiplexing WORD inputs. Used to direct the value of one of the selected inputs to a predefined output.

## ■ Logic processing



### BOOLEAN (SIX INPUTS/TWO OUTPUTS)

Management of two Boolean equations.

**For details of any other specific function, see pages 66-67.**

“ We constantly need to update the various automation configurations according to the environment in which our equipment is used.

With **more than 50 function blocks available, Millenium 3** gives us this flexibility. What's more, I can connect up to 700 function blocks in the same program. This enables me to devise highly complex applications.

Steve, Moulding Press Manufacturer ”





## ■ 20 specific preprogrammed FBDC functions (continued)

### ■ SFC



#### WAIT SFC STEP

Sets up a wait phase or step for a PLC or a device.



#### MOVE SFC STEP

Sets up a move step for a motor controlled by the PLC to a position specified on the TARGET input.



#### MOTOR MULTIPLEXER

Combines the motor control signals produced by two linked MOVE SFC steps.

### ■ Sensor



#### NEW GAIN

Acts as the interface between the Crouzet pressure transmitters and the Millenium 3 logic controller.



#### NEW LEVEL

Calculates the level of liquid in an open or closed tank, with or without constant density, using pressure sensors.



#### NEW FLOW

Calculates the flow of a liquid in a pipe using a differential pressure element or by measuring the dynamic pressure.



#### NEW 5 THRESHOLDS

This function compares a value against 5 thresholds.

### ■ Regulation



#### ANALOGUE PID

Temperature control (pressure or other) with analogue output.



#### PID PWM

Temperature control (pressure or other) with digital output.



#### PUMP MANAGEMENT

Pump rotation function

### ■ Application

For details of any other specific function, see pages 66-67.

## ■ 7 Grafcet SFC functions

For sequential automation systems (Sequential Function Chart).

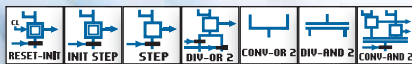

## ■ 6 logic functions

AND, OR, NAND, NOR, XOR, NOT.

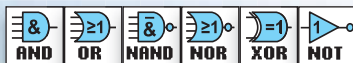

## ■ 5 output functions

Physical outputs (relay, solid state or PWM) and internal outputs (backlighting).



## ■ 17 input functions

Physical inputs (digital, potentiometer or 10-bit analogue) and internal inputs (buttons, constants).

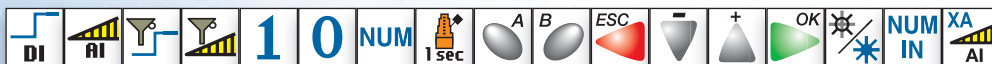

# Introduction to programming software

## Ladder language

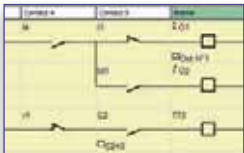

■ Electrical symbols

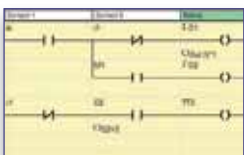

■ Ladder symbols

The M3 SOFT CD-ROM contains all the symbols used in Ladder language. You can choose between two types of graphic representation: Ladder or electrical symbols.

### ■ 13 Ladder functions

#### ■ Inputs



##### DIGITAL INPUTS

This contact represents the state of the controller input connected to a sensor (pushbutton, switch, detector, etc).



##### A/B BUTTONS

The A and B buttons behave exactly like physical inputs. They correspond to the grey A and B buttons on the front of the controller.



##### SUMMER WINTER

This function output is in the OFF state for the whole of wintertime and changes to the ON state for the whole of summertime.

#### ■ Outputs



##### DIGITAL OUTPUTS

The digital outputs correspond to the controller output relay coils (connected to the actuators).



##### AUXILIARY RELAYS

The auxiliary relays, marked M, behave exactly like digital outputs, but do not have an output electrical contact. They can be used as internal variables.

#### ■ Timer/clock



##### TIMERS

The TIMERS function block provides access to the following functions: delaying or prolonging actions for a predefined time, management of flashing cycles, creating pulses, etc.



##### CLOCKS

The Clocks or Time Prog function is used to enable time slots during which it will be possible to execute actions.

#### ■ Counter



##### COUNTERS

Upcounts or downcounts pulses.



##### HIGH-SPEED COUNTER

Counts pulses up to a frequency of 1 kHz.



##### COUNTER COMPARATORS

Compares the current counter value of two counters or of one counter and a constant value.

#### ■ Display



##### LCD BACKLIGHTING

The screen Backlighting output is used to control the LCD display lighting via the program.



##### TEXT BLOCKS

The Text automation function is used to display text and/or numerical values (current value, preset value, etc.) on the LCD display rather than on the INPUTS-OUTPUTS screen.

#### ■ Communication



##### MESSAGE

When activated, the Message function block can be used to:

- send alarm messages to mobile phones, to the M3 Alarm tool or to e-mail addresses via the M3MOD communication interface.
- provide remote access to a digital variable and/or a numerical variable, in order to read or modify them.

“ I wasn't really into programming at first. Here at least, I can choose the language that suits me best. As I am an electrical engineer by training, with Ladder language, it's what I understand!

Olivier, Electrical Installer





## Whatever your activity



■ Building Management Systems



■ Industry



■ Advertising hoardings



■ Water treatment



■ Renewable energies

## Millenium 3 offers the most suitable solution for your application.

### ▶ Building Management Systems

---

- Lighting control systems
- Air conditioning and heating systems
- Lifts, hoists and escalators
- Automatic doors and barriers

### ▶ Industry

---

- Packing machines
- Woodworking machines
- Conveyors
- Moulding machines

### ▶ Commercial equipment

---

- Automatic washing equipment
- Vending machines
- Advertising hoardings
- Toll barriers

### ▶ Water treatment/Agriculture

---

- Farm machinery
- Irrigation/sprinkler systems
- Pump management

### ▶ Renewable energies

---

- Solar panels
- Wind turbines
- Heat pumps

# Applications

## ▶ Focus on the “**compressor**” application



### Pressure transmitter: Easily avoid breakdowns!

- The pressure transmitter measures the compressor’s **supply and outlet pressures** to control the motor according to the required displayed pressure, thereby ensuring maximum efficiency.
- **Ready-to-use**, the pressure transmitter’s reference and specifications are preset in the Millenium 3 logic controller, allowing **safe, speedy and effective installation**, using dedicated function blocks.

### Millenium 3: The logic controller at the heart of your equipment!

- The Millenium 3 logic controller has everything you need to **control your compressors effectively**: easy to operate, preset applications, adapted function blocks.
- The Millenium 3 gathers and processes data such as relative **humidity, temperature and pressure** to co-ordinate operation of one or more compressors.
- A dedicated function ensures simultaneous **management of 4 or more compressors**, in order to extend their working life.

“ By opting for a Millenium 3 automation solution, **I get the benefit of perfect synchronisation** between logic controller, probes, sensors, control relays, timers and, defrost relays.

This is a real plus for us! We are able to derive significant benefits in terms of design, integration and installation.

*Edith, Quality Manager  
for compressor manufacture*



# Millenium 3 Standard

## → General characteristics

- Millenium 3 Compact Range
- Millenium 3 Expandable Range
- Millenium 3 Communication Options



Millenium 3 range

### General environment characteristics for CB, CD, XD, XB, XR and XE product types

<b>Certifications</b> ●	UL, CSA GL: except for 88 970 32x (pending)
<b>Conformity with the low voltage directive</b>	In accordance with 73/23/EEC: EN (IEC) 61131-2 (Open equipment)
<b>Conformity with the EMC directive</b> ●	In accordance with 89/336/EEC: EN (IEC) 61131-2 (Zone B) EN (IEC) 61000-6-2, EN (IEC) 61000-6-3 (*) EN (IEC) 61000-6-4
(*) Except configuration (88 970 1.1 or 88 970 1.2) + (88 970 250 or 88 970 270) + 88 970 241 class A (class B: using in metallic cabinet)	
<b>Earthing</b>	None
<b>Protection rating</b> ●	In accordance with IEC/EN 60529: IP40 on front panel IP20 on terminal block
<b>Overvoltage category</b>	3 in accordance with IEC/EN 60664-1
<b>Pollution</b>	Degree: 2 in accordance with IEC/EN 61131-2
<b>Maximum utilisation altitude</b>	Operation: 2000 m Transport: 3.048 m
<b>Mechanical resistance</b> ●	Immunity to vibrations IEC/EN 60068-2-6, Fc test Immunity to shock IEC/EN 60068-2-27, Fa test
<b>Resistance to electrostatic discharge</b>	Immunity to ESD IEC/EN 61000-4-2, level 3
<b>Resistance to HF interference</b>	Immunity to radiated electrostatic fields IEC/EN 61000-4-3, Immunity to fast transients (burst immunity) IEC/EN 61000-4-4, level 3 Immunity to shock waves IEC/EN 61000-4-5 Radio frequency in common mode IEC/EN 61000-4-6, level 3 Voltage dips and breaks (~) IEC/EN 61000-4-11 Immunity to damped oscillatory waves IEC/EN 61000-4-12
<b>Conducted and radiated emissions</b>	Class B (*) in accordance with EN 55022/11 group 1
(*) Except configuration (88 970 1.1 or 88 970 1.2) + (88 970 250 or 88 970 270) + 88 970 241 class A (class B in metallic cabinet)	
<b>Operating temperature</b>	-20 → +55°C (+40°C in a non-ventilated enclosure) in accordance with IEC/EN 60068-2-1 and IEC/EN 60068-2-2
<b>Storage temperature</b>	-40 → +70°C in accordance with IEC/EN 60068-2-1 and IEC/EN 60068-2-2
<b>Relative humidity</b>	95% max. (no condensation or dripping water) in accordance with IEC/EN 60068-2-30
<b>Mounting</b>	On symmetrical DIN profile, 35 x 7.5 mm and 35 mm x 15 or panel (2 x 4 mm Ø)
<b>Screw terminals connection capacity</b>	<b>Flexible wire with ferrule =</b> 1 conductor: 0.25 to 2.5 mm <sup>2</sup> (AWG 24...AWG 14) 2 conductors 0.25 to 0.75 mm <sup>2</sup> (AWG 24...AWG 18) <b>Semi-rigid wire =</b> 1 conductor: 0.2 to 2.5 mm <sup>2</sup> (AWG 25...AWG 14) <b>Rigid wire =</b> 1 conductor: 0.2 to 2.5 mm <sup>2</sup> (AWG 25...AWG 14) 2 conductors 0.2 to 1.5 mm <sup>2</sup> (AWG 25...AWG 16) <b>Tightening torque =</b> 0.5 N.m (4.5 lb-in) (tighten using screwdriver diam. 3.5 mm)

● : For adapted products, see page page 64-65

## Processing characteristics of CB, CD, XD & XB product types

<b>LCD display</b>	CD, XD: Display with 4 lines of 18 characters
<b>Programming method</b>	Ladder or function blocks/SFC (Grafcet)
<b>Program size</b>	Ladder: 120 lines Function blocks: CB, CD: typically 350 blocks XB, XD: typically 700 blocks
<b>Program memory</b>	Flash EEPROM
<b>Removable memory</b>	EEPROM
<b>Data memory</b>	368 bits/200 words
<b>Back-up time in the event of power failure</b>	Program and settings in the controller: 10 years Program and settings in the plug-in memory: 10 years Data memory: 10 years
<b>Cycle time</b>	Ladder: typically 20 ms Function blocks: 6 → 90 ms
<b>Response time</b>	Input acquisition time + 1 to 2 cycle times
<b>Clock data retention</b>	10 years (lithium battery) at 25°C
<b>Clock drift</b>	Drift < 12 min/year (at 25°C) 6 s/month (at 25°C with user-definable correction of drift)
<b>Timer block accuracy</b>	1% ± 2 cycle times
<b>Start up time on power up</b>	< 1.2 s

## Characteristics of products with AC power supplied

Supply	24 V ~ (88970..4)	100 → 240 V ~ (88970..3)
<b>Nominal voltage</b> ●	24 V ~	100 → 240 V ~
<b>Operating limits</b> ●	-15% / +20% or 20.4 V ~ → 28.8 V ~	-15% / +10% or 85 V ~ → 264 V ~
<b>Supply frequency range</b>	50/60 Hz (+4% / -6%) or 47 → 53 Hz/57 → 63 Hz	50/60 Hz (+4% / -6%) or 47 → 53 Hz/57 → 63 Hz
<b>Immunity from micro power cuts</b>	10 ms (repetition 20 times)	10 ms (repetition 20 times)
<b>Max. absorbed power</b>	CB12-CD12-XD10-XB10: 4 VA CB20-CD20: 6 VA XD10 with extension - XD26-XB26: 7.5 VA XD26-XB26 with extension: 10 VA	CB12-CD12-XD10-XB10: 7 VA CB20-CD20: 11 VA XD10-XB10 with extension-XD26-XB26: 12 VA XD26-XB26 with extension: 17 VA
<b>Isolation voltage</b>	1780 V ~	1780 V ~
<b>Inputs</b>	24 V ~ (88970..4)	100 → 240 V ~ (88970..3)
<b>Input voltage</b> ●	24 V ~ (-15% / +20%)	100 → 240 V ~ (-15% / +10%)
<b>Input current</b> ●	4.4 mA @ 20.4 V ~ 5.2 mA @ 24.0 V ~ 6.3 mA @ 28.8 V ~	0.24 mA @ 85 V ~ 0.75 mA @ 264 V ~
<b>Input impedance</b> ●	4.6 kΩ	350 kΩ
<b>Logic 1 voltage threshold</b> ●	≥ 14 V ~	≥ 79 V ~
<b>Making current at logic state 1</b> ●	> 2 mA	> 0.17 mA
<b>Logic 0 voltage threshold</b> ●	≤ 5 V ~	≤ 20 V ~ (≤ 28 V ~ : XE10, XR06, XR10, XR14)
<b>Release current at logic state 0</b> ●	< 0.5 mA	< 0.5 mA
<b>Response time with LADDER programming</b>	50 ms - State 0 → 1 (50/60 Hz)	50 ms - State 0 < 1 (50/60 Hz)
<b>Response time with function blocks programming</b>	Configurable in increments of 10 ms 50 ms min. up to 255 ms State 0 → 1 (50/60 Hz)	Configurable in increments of 10 ms 50 ms min. up to 255 ms State 0 → 1 (50/60 Hz)
<b>Maximum counting frequency</b>	In accordance with cycle time (Tc) and input response time (Tr) : $1 / ((2 \times Tc) + Tr)$	In accordance with cycle time (Tc) and input response time (Tr) : $1 / ((2 \times Tc) + Tr)$
<b>Sensor type</b>	Contact or 3-wire PNP	Contact or 3-wire PNP
<b>Input type</b>	Resistive	Resistive
<b>Isolation between power supply and inputs</b>	None	None
<b>Isolation between inputs</b>	None	None
<b>Protection against polarity inversions</b>	Yes	Yes
<b>Status indicator</b>	On LCD screen for CD and XD	On LCD screen for CD and XD
<b>Characteristics of relay outputs common to the entire range</b>		
<b>Max. breaking voltage</b> ●	5 → 30 V ~ 24 → 250 V ~	
<b>Breaking current</b> ●	CB-CD-XB10-XD10-XR06-XR10: 8 A XD26-XB26: 8 x 8 A relays, 2 x 5 A relays XE10: 4 x 5 A relays XR14: 4 x 8 A relays, 2 x 5 A relays	
<b>Max. Output Common Current</b>	12A for O8, O9, OA	

● : For adapted products, see page page 64-65

# Millenium 3 Standard

Electrical durability for 500 000 operating cycles	Usage category DC-12: 24 V, 1.5 A Usage category DC-13: 24 V (L/R = 10 ms), 0.6 A Usage category AC-12: 230 V, 1.5 A Usage category AC-15: 230 V, 0.9 A
Minimum switching capacity	10 mA (at minimum voltage of 12 V)
Minimum load	12 V, 10 mA
Maximum rate	Off load: 10 Hz
Mechanical life	10.000.000 operations (cycles)
Voltage for withstanding shocks	In accordance with IEC/EN 60947-1 and IEC/EN 60664-1: 4 kV
Response time	Make 10 ms Release 5 ms
Built-in protections	Against short-circuits: None Against overvoltages and overloads: None
Status indicator	On LCD screen for CD and XD

## Characteristics of product with DC power supplied

Supply	12 V $\overline{\text{---}}$ (88970..5 & 88970814 & 88970840)	24 V $\overline{\text{---}}$ (88970..1 & 88970..2)
Nominal voltage ●	12 V $\overline{\text{---}}$	24 V $\overline{\text{---}}$
Operating limits ●	-13% / +20% or 10.4 V $\overline{\text{---}}$ < 14.4 V $\overline{\text{---}}$ (including ripple)	-20% / +25% or 19.2 V $\overline{\text{---}}$ < 30 V $\overline{\text{---}}$ (including ripple)
Immunity from micro power cuts	≤ 1 ms (repetition 20 times)	≤ 1 ms (repetition 20 times)
Max. absorbed power	CB12 with solid state outputs: 1.5 W CD12: 1.5 W CD20: 2.5 W XD26-XB26: 3 W XD26-XB26 with extension: 5 W XD26 with solid state outputs: 2.5 W	CB12-CD12-CD20 with solid state outputs - XD10-XB10 with solid state outputs: 3 W XD10-XB10 with relay outputs: 4 W XD26-XB26 with solid state outputs: 5 W CB20-CD20 with relay outputs-XD26 with relay outputs: 6 W XD10-XB10 with extension: 8 W XD26-XB26 with extension: 10 W
Protection against polarity inversions	Yes	Yes
Digital inputs (I1 to IA and IH to IY)	12 V $\overline{\text{---}}$ (88970..5 & 88970814 & 88970840)	24 V $\overline{\text{---}}$ (88970..1 & 88970..2)
Input voltage ●	12 V $\overline{\text{---}}$ (-13% / +20%)	24 V $\overline{\text{---}}$ (-20% / +25%)
Input current ●	3.9 mA @ 10.44 V $\overline{\text{---}}$ 4.4 mA @ 12.0 V $\overline{\text{---}}$ 5.3 mA @ 14.4 V $\overline{\text{---}}$	2.6 mA @ 19.2 V $\overline{\text{---}}$ 3.2 mA @ 24 V $\overline{\text{---}}$ 4.0 mA @ 30.0 V $\overline{\text{---}}$
Input impedance ●	2.7 k $\Omega$	7.4 k $\Omega$
Logic 1 voltage threshold ●	≥ 7 V $\overline{\text{---}}$	≥ 15 V $\overline{\text{---}}$
Making current at logic state 1 ●	≥ 2 mA	≥ 2.2 mA
Logic 0 voltage threshold ●	≤ 3 V $\overline{\text{---}}$	≤ 5 V $\overline{\text{---}}$
Release current at logic state 0 ●	< 0.9 mA	< 0.75 mA
Response time	1 → 2 cycle times	1 → 2 cycle times
Maximum counting frequency	I1 & I2: Ladder (1 kHz) & FBD (Up to 6 kHz) I3 to IA & IH to IY: in accordance with cycle time (Tc) and input response time (Tr) : 1/ ((2 x Tc) + Tr)	I1 & I2: Ladder (1 kHz) & FBD (Up to 6 kHz) I3 to IA & IH to IY: in accordance with cycle time (Tc) and input response time (Tr) : 1/ ((2 x Tc) + Tr)
Sensor type	Contact or 3-wire PNP	Contact or 3-wire PNP
Conforming to IEC/EN 61131-2	Type 1	Type 1
Input type	Resistive	Resistive
Isolation between power supply and inputs	None	None
Isolation between inputs	None	None
Protection against polarity inversions	Yes	Yes
Status indicator	On LCD screen for CD and XD	On LCD screen for CD and XD
Analogue or digital inputs (IB to IG)	12 V $\overline{\text{---}}$ (88970..5 & 88970814 & 88970840)	24 V $\overline{\text{---}}$ (88970..1 & 88970..2)
CB12-CD12-XD10-XB10	4 inputs IB → IE	4 inputs IB → IE
CB20-CD20-XB26-XD26	6 inputs IB → IG	6 inputs IB → IG
Inputs used as analogue inputs		
Measurement range ●	(0 → 10 V) or (0 → V power supply)	(0 → 10 V) or (0 → V power supply)
Input impedance ●	14 k $\Omega$	12 k $\Omega$
Input voltage ●	14.4 V $\overline{\text{---}}$ max	30 V $\overline{\text{---}}$ max
Value of LSB ●	14 mV, 4 mA	29 mV, 4 mA
Input type	Common mode	Common mode
Resolution	10 bit at maximum input voltage	10 bit at maximum input voltage
Conversion time	Controller cycle time	Controller cycle time
Accuracy at 25°C	±5%	±5%
Accuracy at 55°C	± 6.2%	± 6.2%
Repeat accuracy at 55 °C	± 2%	± 2%
Isolation between analogue channel and power supply	None	None
Cable length	10 m maximum, with shielded cable (sensor not isolated)	10 m maximum, with shielded cable (sensor not isolated)
Protection against polarity inversions	Yes	Yes

● :For adapted products, see page page 64-65



Potentiometer control	2.2 k $\Omega$ /0.5 W (recommended) 10 k $\Omega$ max.	2.2 k $\Omega$ /0.5 W (recommended) 10 k $\Omega$ max.
<b>Inputs used as digital inputs</b>		
Input voltage ●	12 V $\overline{\text{---}}$ (-13% / +20%)	24 V $\overline{\text{---}}$ (-20% / +25%)
Input current ●	0.7 mA @ 10.44 V $\overline{\text{---}}$ 0.9 mA @ 12.0 V $\overline{\text{---}}$ 1.0 mA @ 14.4V $\overline{\text{---}}$	1.6 mA @ 19.2 V $\overline{\text{---}}$ 2.0 mA @ 24.0 V $\overline{\text{---}}$ 2.5 mA @ 30.0 V $\overline{\text{---}}$
Input impedance ●	14 k $\Omega$	12 k $\Omega$
Logic 1 voltage threshold ●	$\geq 7$ V $\overline{\text{---}}$	$\geq 15$ V $\overline{\text{---}}$
Making current at logic state 1 ●	$\geq 0.5$ mA	$\geq 1.2$ mA
Logic 0 voltage threshold ●	$\leq 3$ V $\overline{\text{---}}$	$\leq 5$ V $\overline{\text{---}}$
Release current at logic state 0 ●	$\leq 0.2$ mA	$\leq 0.5$ mA
Response time	1 $\rightarrow$ 2 cycle times	1 $\rightarrow$ 2 cycle times
Maximum counting frequency	In accordance with cycle time (Tc) and input response time (Tr) : 1/ ( (2 x Tc) + Tr)	In accordance with cycle time (Tc) and input response time (Tr) : 1/ ( (2 x Tc) + Tr)
Sensor type	Contact or 3-wire PNP	Contact or 3-wire PNP
Conforming to IEC/EN 61131-2	Type 1	Type 1
Input type	Resistive	Resistive
Isolation between power supply and inputs	None	None
Isolation between inputs	None	None
Protection against polarity inversions	Yes	Yes
Status indicator	On LCD screen for CD and XD	On LCD screen for CD and XD
<b>Characteristics of relay outputs common to the entire range</b>		
Max. breaking voltage ●	5 $\rightarrow$ 30 V $\overline{\text{---}}$ 24 $\rightarrow$ 250 V $\sim$	
Breaking current ●	CB-CD-XD10-XB10-XR06-XR10: 8 A XD26-XB26: 8 x 8 A relays, 2 x 5 A relays XE10: 4 x 5 A relays XR14: 4 x 8 A relays, 2 x 5 A relays	
Max. Output Common Current	12A for O8,O9,OA	
Electrical durability for 500 000 operating cycles	Usage category DC-12: 24 V, 1.5 A Usage category DC-13: 24 V (L/R = 10 ms), 0.6 A Usage category AC-12: 230 V, 1.5 A Usage category AC-15: 230 V, 0.9 A	
Minimum switching capacity	10 mA (at minimum voltage of 12 V)	
Minimum load	12 V, 10 mA	
Maximum rate	Off load: 10 Hz At operating current: 0.1 Hz	
Mechanical life	10.000.000 operations (cycles)	
Voltage for withstanding shocks	In accordance with IEC/EN 60947-1 and IEC/EN 60664-1: 4 kV	
Response time	Make 10 ms Release 5 ms	
Built-in protections	Against short-circuits: None Against overvoltages and overloads: None	
Status indicator	On LCD screen for CD and XD	
Digital / PWM solid state output	<b>12-24 V<math>\overline{\text{---}}</math></b> <b>(88970814 &amp; 88970840)</b>	<b>24 V<math>\overline{\text{---}}</math></b> <b>(88970..2)</b>
PWM solid state output*	CB12: O4 XD26: O4 $\rightarrow$ O7	CD12-XD10-XB10: O4 CD20-XD26-XB26: O4 $\rightarrow$ O7
* Only available with "FBD" programming language		
Breaking voltage ●	10.4 $\rightarrow$ 30 V $\overline{\text{---}}$	19.2 $\rightarrow$ 30 V $\overline{\text{---}}$
Nominal voltage ●	12-24 V $\overline{\text{---}}$	24 V $\overline{\text{---}}$
Nominal current ●	0.5 A	0.5 A
Max. breaking current ●	0.625 A	0.625 A
Voltage drop	$\leq 2$ V for I = 0.5 A (at state 1)	$\leq 2$ V for I = 0.5 A (at state 1)
Response time	Make $\leq 1$ ms Release $\leq 1$ ms	Make $\leq 1$ ms Release $\leq 1$ ms
Built-in protections	Against overloads and short-circuits: Yes Against overvoltages (*) : Yes Against inversions of power supply: Yes	Against overloads and short-circuits: Yes Against overvoltages (*) : Yes Against inversions of power supply: Yes
(*) In the absence of a volt-free contact between the output of the logic controller and the load		
Min. load	1 mA	1 mA
Maximum incandescent load	0.2 A / 12 V $\overline{\text{---}}$ 0.1 A / 24 V $\overline{\text{---}}$	0.1 A / 24 V $\overline{\text{---}}$
Galvanic isolation	No	No
PWM frequency	14.11 Hz - 56.45 Hz - 112.90 Hz - 225.80 Hz - 451.59 Hz - 1806.37 Hz	14.11 Hz - 56.45 Hz - 112.90 Hz - 225.80 Hz - 451.59 Hz - 1806.37 Hz
PWM cyclic ratio	0 $\rightarrow$ 100% (256 steps for CD, XD and 1024 for XA)	0 $\rightarrow$ 100% (256 steps for CD, XD and 1024 for XA)
PWM accuracy at 120 Hz	$< 5\%$ (20% $\rightarrow$ 80%) load at 10 mA	$< 5\%$ (20% $\rightarrow$ 80%) load at 10 mA
PWM accuracy at 500 Hz	$< 10\%$ (20% $\rightarrow$ 80%) load at 10 mA	$< 10\%$ (20% $\rightarrow$ 80%) load at 10 mA
Status indicator	On LCD screen for XD	On LCD screen for CD and XD





● :For adapted products, see page page 64-65

# Millenium3



## Millenium 3 logic controllers



Type	Part number	Power supply	Inputs	Outputs	
<b>With display</b>					
	<b>CD12</b>	88970041	24 V $\overline{\text{---}}$	8 digital (of which 4 are analogue)	4 x 8 A relays
		88970042	24 V $\overline{\text{---}}$	8 digital (of which 4 are analogue)	4 solid state 0.5 A (of which 1 is PWM)
		88970043	100 $\rightarrow$ 240 V $\sim$	8 digital	4 x 8 A relays
		88970044	24 V $\sim$	8 digital	4 x 8 A relays
		88970045	12 V $\overline{\text{---}}$	8 digital (of which 4 are analogue)	4 x 8 A relays
	<b>CD20</b>	88970051	24 V $\overline{\text{---}}$	12 digital (of which 6 are analogue)	8 x 8 A relays
		88970052	24 V $\overline{\text{---}}$	12 digital (of which 6 are analogue)	8 solid state 0.5 A (of which 4 are PWM)
		88970053	100 $\rightarrow$ 240 V $\sim$	12 digital	8 x 8 A relays
		88970054	24 V $\sim$	12 digital	8 x 8 A relays
		88970055	12 V $\overline{\text{---}}$	12 digital (of which 6 are analogue)	8 x 8 A relays
<b>Without display</b>					
	<b>CB12</b>	88970021	24 V $\overline{\text{---}}$	8 digital (of which 4 are analogue)	4 x 8 A relays
		88970023	100 $\rightarrow$ 240 V $\sim$	8 digital	4 x 8 A relays
		88970024	24 V $\sim$	8 digital	4 x 8 A relays
		88970840 <b>NEW</b>	12 V $\overline{\text{---}}$	8 digital (of which 4 are analogue)	4 solid state 0.5 A (of which 1 is PWM)
	<b>CB20</b>	88970031	24 V $\overline{\text{---}}$	12 digital (of which 6 are analogue)	8 x 8 A relays
		88970033	100 $\rightarrow$ 240 V $\sim$	12 digital	8 x 8 A relays
		88970034	24 V $\sim$	12 digital	8 x 8 A relays



■ Ergonomic display



■ Optimum memory capacity

Millenium 3 logic controllers operate with the following software:



### ■ M3 SOFT









Multilingual programming software (CD-ROM) including a library of specific functions.  
Part no.: 88970111

### ■ M3 ALARM

Alarm management software (CD-ROM)  
Part no.: 88970116  
This software is used alongside the M3MOD communication interface (part no.: 88970117).

For all details of hardware adaptation, see pages 64-65.

# “Compact” range selection guide

Modem communication solutions			Modular power supplies <sup>(1)</sup>					Starter kits and demo case
M3MOD	STN	GSM	12 V DC - 24 W	24 V DC - 7.5 W	24 V DC - 15 W	24 V DC - 30 W	24 V DC - 60 W	
								
88970117	88970118	88970119	88950306	88950303	88950304	88950307	88950302	Standard
<input checked="" type="checkbox"/>	<input type="checkbox"/>	<input type="checkbox"/>		<input checked="" type="checkbox"/>	<input checked="" type="checkbox"/>	<input checked="" type="checkbox"/>	<input checked="" type="checkbox"/>	88970080
<input checked="" type="checkbox"/>	<input type="checkbox"/>	<input type="checkbox"/>		<input checked="" type="checkbox"/>	<input checked="" type="checkbox"/>	<input checked="" type="checkbox"/>	<input checked="" type="checkbox"/>	88970106 (case)
<input checked="" type="checkbox"/>	<input type="checkbox"/>	<input type="checkbox"/>						88970081
<input checked="" type="checkbox"/>	<input type="checkbox"/>	<input type="checkbox"/>	<input checked="" type="checkbox"/>					
<input checked="" type="checkbox"/>	<input type="checkbox"/>	<input type="checkbox"/>		<input checked="" type="checkbox"/>	<input checked="" type="checkbox"/>	<input checked="" type="checkbox"/>	<input checked="" type="checkbox"/>	88970082
<input checked="" type="checkbox"/>	<input type="checkbox"/>	<input type="checkbox"/>		<input checked="" type="checkbox"/>	<input checked="" type="checkbox"/>	<input checked="" type="checkbox"/>	<input checked="" type="checkbox"/>	88970083
<input checked="" type="checkbox"/>	<input type="checkbox"/>	<input type="checkbox"/>	<input checked="" type="checkbox"/>					
<input checked="" type="checkbox"/>	<input type="checkbox"/>	<input type="checkbox"/>		<input checked="" type="checkbox"/>	<input checked="" type="checkbox"/>	<input checked="" type="checkbox"/>	<input checked="" type="checkbox"/>	
<input checked="" type="checkbox"/>	<input type="checkbox"/>	<input type="checkbox"/>		<input checked="" type="checkbox"/>	<input checked="" type="checkbox"/>	<input checked="" type="checkbox"/>	<input checked="" type="checkbox"/>	
<input checked="" type="checkbox"/>	<input type="checkbox"/>	<input type="checkbox"/>	<input checked="" type="checkbox"/>					
<input checked="" type="checkbox"/>	<input type="checkbox"/>	<input type="checkbox"/>		<input checked="" type="checkbox"/>	<input checked="" type="checkbox"/>	<input checked="" type="checkbox"/>	<input checked="" type="checkbox"/>	
<input checked="" type="checkbox"/>	<input type="checkbox"/>	<input type="checkbox"/>						

Compatible  
 Mounted with the M3MOD:  
 - STN modem,  
 - or GSM modem

<sup>(1)</sup> Find the whole “Power Supplies” offer on pages 58-59.



#### The 4 starter kits each contain:

- 1 CD12 or CD20 logic controller + 1 USB link cable + 1 M3 SOFT programming software application (CD-ROM) including a library of specific functions.  
Part no.: 88970080 / 88970081 / 88970082 / 88970083



#### The demonstration case contains:

- 1 CD12 logic controller + 1 USB link cable + 1 M3 SOFT programming software application (CD-ROM) including the library of specific functions + 1 voltage adaptor + 1 I/O simulation card.  
Part no.: 88970106

# Millenium 3 Standard

## → "Compact" range with display

- Budget solution with display
- Memory: 120 lines in LADDER language and up to 350 "typical" blocks in FBD language
- LCD with 4 lines of 18 characters and configurable backlighting
- Selective parameter setting: You can choose the parameters that can be adjusted on the front panel
- Analogue inputs 0-10 V $\overline{\text{DC}}$  or 0-20 mA/Pt 100 with converters (see page 50)



CD12



CD20

### Part numbers

Type	Input	Output	Supply	Code
CD12	8 digital (including 4 analogue)	4 relays 8 A	24 V $\overline{\text{DC}}$	88970041
	8 digital (including 4 analogue)	4 solid state 0.5 A (including 1 PWM)	24 V $\overline{\text{DC}}$	88970042
	8 digital	4 relays 8 A	100 → 240 V $\sim$	88970043
	8 digital	4 relays 8 A	24 V $\sim$	88970044
	8 digital (including 4 analogue)	4 relays 8 A	12 V $\overline{\text{DC}}$	88970045
CD20	12 digital (including 6 analogue)	8 relays 8 A	24 V $\overline{\text{DC}}$	88970051
	12 digital (including 6 analogue)	8 solid state 0.5 A (including 4 PWM)	24 V $\overline{\text{DC}}$	88970052
	12 digital	8 relays 8 A	100 → 240 V $\sim$	88970053
	12 digital	8 relays 8 A	24 V $\sim$	88970054
	12 digital (including 6 analogue)	8 relays 8 A	12 V $\overline{\text{DC}}$	88970055

### Accessories

Type	Description	Code
M3 SOFT	Multilingual programming software containing specific library functions (CD-ROM)	88970111
PA	EEPROM memory cartridge	88970108
	3 m serial link cable: PC → Millenium 3	88970102
	3 m USB link cable: PC → Millenium 3	88970109
	Millenium 3 → Bluetooth interface (class A 10 m)	88970104

### Starter kits (see page 27 for details)

Type	Input	Output	Supply	Code
Kit 12	8 digital (including 4 analogue)	4 relays	24 V $\overline{\text{DC}}$	88970080
	8 digital	4 relays	100 → 240 V $\sim$	88970081
Kit 20	12 digital (including 6 analogue)	8 relays	24 V $\overline{\text{DC}}$	88970082
	12 digital	8 relays	100 → 240 V $\sim$	88970083

### Dimensions (mm)

CD12

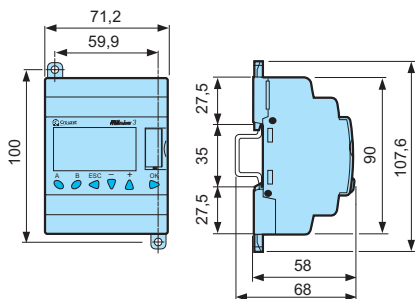

CD20

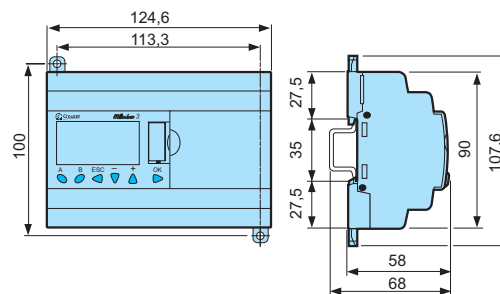

### Input / Output Connections

See Page 40-43 for details or to find instruction sheets visit: [www.millenium3.crouzet.com](http://www.millenium3.crouzet.com) in "Download"

For adapted products, see page page 64-65

## → "Compact" range without display

- Simply a control system solution inside a modular casing
- Memory: 120 lines in LADDER language and up to 350 "typical" blocks in FBD language
- No display or parameter-setting buttons to avoid tampering by unauthorised users
- Analogue inputs 0-10 V $\overline{\text{DC}}$  or 0-20 mA/Pt 100 with converters (see page 50)



CB12



CB20

### Part numbers

Type	Input	Output	Supply	Code
CB12	8 digital (including 4 analogue)	4 relays 8 A	24 V $\overline{\text{DC}}$	88970021
	8 digital	4 relays 8 A	100 $\rightarrow$ 240 V $\sim$	88970023
	8 digital	4 relays 8 A	24 V $\sim$	88970024
	8 digital (including 4 analogue)	4 solid state 0.5 A (including 1 PWM)	12 V $\overline{\text{DC}}$	88970840
CB20	12 digital (including 6 analogue)	8 relays 8 A	24 V $\overline{\text{DC}}$	88970031
	12 digital	8 relays 8 A	100 $\rightarrow$ 240 V $\sim$	88970033
	12 digital	8 relays 8 A	24 V $\sim$	88970034

### Accessories

Type	Description	Code
M3 SOFT	Multilingual programming software containing specific library functions (CD-ROM)	88970111
PA	EEPROM memory cartridge	88970108
	3 m serial link cable: PC $\rightarrow$ Millenium 3	88970102
	3 m USB link cable: PC $\rightarrow$ Millenium 3	88970109
	Millenium 3 $\rightarrow$ Bluetooth interface (class A 10 m)	88970104

### Dimensions (mm)

CB12

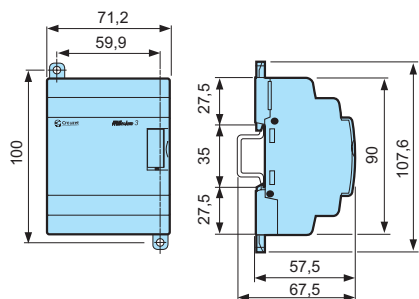

CB20

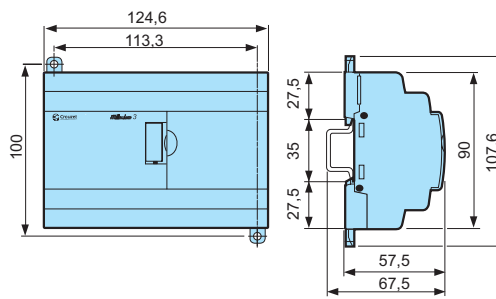

### Input / Output Connections

See Page 40-43 for details or to find instruction sheets visit: [www.millenium3.crouzet.com](http://www.millenium3.crouzet.com) in "Download"

For adapted products, see page page 64-65

# Millenium3



## Millenium 3 logic controllers



Type	Part number	Power supply	Inputs	Outputs	
	With XD10/ XD26 display	Without display XB10/XB26			
	88970141	88970131 <b>NEW</b>	24 V $\text{---}$	6 digital (of which 4 are analogue)	4 x 8 A relays
	88970142	88970132 <b>NEW</b>	24 V $\text{---}$	6 digital (of which 4 are analogue)	4 solid state 0.5 A (of which 1 is PWM)
	88970143	88970133 <b>NEW</b>	100 $\rightarrow$ 240 V $\sim$	6 digital	4 x 8 A relays
	88970144	88970134 <b>NEW</b>	24 V $\sim$	6 digital	4 x 8 A relays
	88970161	88970151 <b>NEW</b>	24 V $\text{---}$	16 digital (of which 6 are analogue)	10 relays, of which 8 are 8 A and 2 are 5 A
	88970162	88970152 <b>NEW</b>	24 V $\text{---}$	16 digital (of which 6 are analogue)	10 solid state 0.5 A (of which 4 are PWM)
	88970163	88970153 <b>NEW</b>	100 $\rightarrow$ 240 V $\sim$	16 digital	10 relays, of which 8 are 8 A and 2 are 5 A
	88970164	88970154 <b>NEW</b>	24 V $\sim$	16 digital	10 relays, of which 8 are 8 A and 2 are 5 A
	88970165	88970155 <b>NEW</b>	12 V $\text{---}$	16 digital (of which 6 are analogue)	10 relays, of which 8 are 8 A and 2 are 5 A
	88970814 <b>NEW</b>	-	12 V $\text{---}$	16 digital (of which 6 are analogue)	10 solid state 0.5 A (of which 4 are PWM)

## Extensions "Sandwich"

Type	Part number	Power supply	Inputs	Outputs		
<b>TOR</b>						
	XE10	88970321	Via the 24 V $\text{---}$ controller	6 digital	4 x 5 A relays, 1 of which is a changeover relay	
		88970323	100 $\rightarrow$ 240 V $\sim$	6 digital	4 x 5 A relays, 1 of which is a changeover relay	
		88970324	24 V $\sim$	6 digital	4 x 5 A relays, 1 of which is a changeover relay	
<b>Communication</b>						
	XN05	88970270	Via the 24 V $\text{---}$ controller	Modbus TCP Ethernet protocol	Read: 8 - Read/Write: 8 Clock: 4 - Status: 1	
		XN03	88970250	Via the 24 V $\text{---}$ controller	Modbus RS-485 (slave)	Read: 8 - Read/Write: 8 Clock: 4 - Status: 1
		XN06	88972250 <b>NEW</b>	Via the 24 V $\text{---}$ controller	Modbus RS-485 (slave)	Read: 8 - Read/Write: 8 Clock: 4 - Status: 1



Millenium 3 logic controllers operate with the following software:

### ■ M3 SOFT

Multilingual programming software (CD-ROM) including the library of specific functions.

Part no.: 88970111

### ■ M3 ALARM

Alarm management software (CD-ROM)

Part no.: 88970116

This software is used alongside the M3MOD communication interface (part no.: 88970117).

For all details of hardware adaptation, see pages 64-65.



# “Expandable” range selection guide

Modem communication solutions			Modular power supplies <sup>(1)</sup>					Starter kits
M3MOD	STN	GSM	12 V DC - 24 W	24 V DC - 7.5 W	24 V DC - 15 W	24 V DC - 30 W	24 V DC - 60 W	
88970117	88970118	88970119	88950306 <b>NEW</b>	88950303 <b>NEW</b>	88950304 <b>NEW</b>	88950307 <b>NEW</b>	88950302	Expandable
<input checked="" type="checkbox"/>	<input type="checkbox"/>	<input type="checkbox"/>		<input checked="" type="checkbox"/>	<input checked="" type="checkbox"/>	<input checked="" type="checkbox"/>	<input checked="" type="checkbox"/>	
<input checked="" type="checkbox"/>	<input type="checkbox"/>	<input type="checkbox"/>		<input checked="" type="checkbox"/>	<input checked="" type="checkbox"/>	<input checked="" type="checkbox"/>	<input checked="" type="checkbox"/>	
<input checked="" type="checkbox"/>	<input type="checkbox"/>	<input type="checkbox"/>		<input checked="" type="checkbox"/>	<input checked="" type="checkbox"/>	<input checked="" type="checkbox"/>	<input checked="" type="checkbox"/>	
<input checked="" type="checkbox"/>	<input type="checkbox"/>	<input type="checkbox"/>		<input checked="" type="checkbox"/>	<input checked="" type="checkbox"/>	<input checked="" type="checkbox"/>	<input checked="" type="checkbox"/>	88970084
<input checked="" type="checkbox"/>	<input type="checkbox"/>	<input type="checkbox"/>		<input checked="" type="checkbox"/>	<input checked="" type="checkbox"/>	<input checked="" type="checkbox"/>	<input checked="" type="checkbox"/>	88970085
<input checked="" type="checkbox"/>	<input type="checkbox"/>	<input type="checkbox"/>	<input checked="" type="checkbox"/>					
<input checked="" type="checkbox"/>	<input type="checkbox"/>	<input type="checkbox"/>	<input checked="" type="checkbox"/>					

- Compatible
- Mounted with the M3MOD:
  - STN modem,
  - or GSM modem

<sup>(1)</sup> Find the whole “Power Supplies” offer on pages 58-59.

Termination extensions					
Type	Part number	Power supply	Inputs	Outputs	
<b>Digital</b>					
	<b>XR06</b>	88970211	Via the 24 V $\overline{\text{DC}}$ controller	4 digital	2 x 8 A relays
		88970213	Via the 100 $\rightarrow$ 240 V $\sim$ controller	4 digital	2 x 8 A relays
		88970214	Via the 24 V $\sim$ controller	4 digital	2 x 8 A relays
		88970215	Via the 12 V $\overline{\text{DC}}$ controller	4 digital	2 x 8 A relays
	<b>XR10</b>	88970221	Via the 24 V $\overline{\text{DC}}$ controller	6 digital	4 x 8 A relays
		88970223	Via the 100 $\rightarrow$ 240 V $\sim$ controller	6 digital	4 x 8 A relays
		88970224	Via the 24 V $\sim$ controller	6 digital	4 x 8 A relays
		88970225	Via the 12 V $\overline{\text{DC}}$ controller	6 digital	4 x 8 A relays
	<b>XR14</b>	88970231	Via the 24 V $\overline{\text{DC}}$ controller	8 digital	6 relays, of which 4 are 8 A and 2 are 5 A
		88970233	Via the 100 $\rightarrow$ 240 V $\sim$ controller	8 digital	6 relays, of which 4 are 8 A and 2 are 5 A
		88970234	Via the 24 V $\sim$ controller	8 digital	6 relays, of which 4 are 8 A and 2 are 5 A
		88970235	Via the 12 V $\overline{\text{DC}}$ controller	8 digital	6 relays, of which 4 are 8 A and 2 are 5 A
<b>Analogue</b>					
	<b>XA04</b>	88970241	Via the 24 V $\overline{\text{DC}}$ controller	1 analogue (0-10 V/0-20 mA), 1 analogue (0-10 V/0-20 mA/Pt100)	2 analogue (0-10 V)/PWM



**The 2 starter kits each contain:**

- 1 XD26 logic controller + 1 USB link cable +
  - 1 M3 SOFT programming software application (CD-ROM) including a library of specific functions.
- Part no.: 88970084 / 88970085

# Millenium 3 Standard

## → "Expandable" range with display

- "High-performance" expandable solution with display
- Extended memory: 120 lines in LADDER language and up to 700 "typical" blocks in FBD language
- LCD with 4 lines of 18 characters and configurable backlighting
- Selective parameter setting: You can choose the parameters that can be adjusted on the front panel
- Analogue inputs 0-10 V  $\overline{\text{DC}}$  or 0-20 mA/Pt 100 with converters (see page 50)
- Open to XN network communication extensions and digital I/O or analogue extensions



XD10



XD26

### Part numbers

Type	Input	Output	Supply	Code
XD10	6 digital (including 4 analogue)	4 relays 8 A	24 V $\overline{\text{DC}}$	88970141
	6 digital (including 4 analogue)	4 solid state 0.5 A (including 1 PWM)	24 V $\overline{\text{DC}}$	88970142
	6 digital	4 relays 8 A	100 → 240 V $\sim$	88970143
	6 digital	4 relays 8 A	24 V $\sim$	88970144
XD26	16 digital (including 6 analogue)	10 relays (8 x 8 A relay and 2 x 5 A relay)	24 V $\overline{\text{DC}}$	88970161
	16 digital (including 6 analogue)	10 solid state 0.5 A (including 4 PWM)	24 V $\overline{\text{DC}}$	88970162
	16 digital	10 relays (8 x 8 A relay and 2 x 5 A relay)	100 → 240 V $\sim$	88970163
	16 digital	10 relays (8 x 8 A relay and 2 x 5 A relay)	24 V $\sim$	88970164
	16 digital (including 6 analogue)	10 relays (8 x 8 A relay and 2 x 5 A relay)	12 V $\overline{\text{DC}}$	88970165
	16 digital (including 6 analogue)	10 solid state 0.5 A (including 4 PWM)	12 V $\overline{\text{DC}}$	88970814

### Accessories

Type	Description	Code
M3 SOFT	Multilingual programming software containing specific library functions (CD-ROM)	88970111
PA	EEPROM memory cartridge	88970108
	3 m serial link cable: PC → Millenium 3	88970102
	3 m USB link cable: PC → Millenium 3	88970109
	Millenium 3 → Bluetooth interface (class A 10 m)	88970104

### Starter kits (see page 31 for details)

Type	Input	Output	Supply	Code
Kit 26	16 digital (including 6 analogue)	10 relays (8 x 8 A relay and 2 x 5 A relay)	24 V $\overline{\text{DC}}$	88970084
	16 digital	10 relays (8 x 8 A relay and 2 x 5 A relay)	100 → 240 V $\sim$	88970085

### Dimensions (mm)

XD10

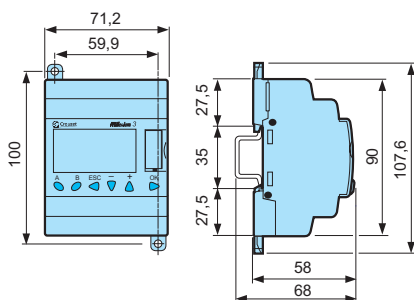

XD26

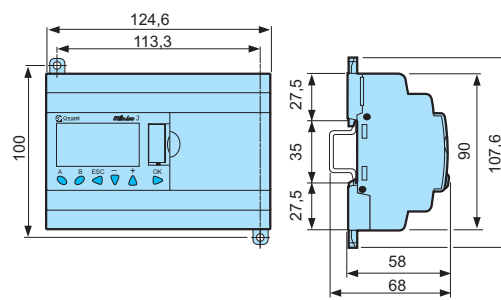

### Input / Output Connections

See Page 40-43 for details or to find instruction sheets visit: [www.millenium3.crouzet.com](http://www.millenium3.crouzet.com) in "Download"

For adapted products, see page 64-65



# Millenium 3 Standard

## → "Expandable" range without display

- "High-performance" expandable solution without display
- Extended memory: 120 lines in LADDER language and up to 700 "typical" blocks in FBD language
- No display or parameter-setting buttons to avoid tampering by unauthorised users
- Analogue inputs 0-10 V  $\overline{\text{---}}$  or 0-20 mA/Pt 100 with converters (see page 50)
- Open to XN network communication extensions and digital I/O or analogue extensions



XB10



XB26

### Part numbers

Type	Input	Output	Supply	Code
XB10	6 digital (including 4 analogue)	4 relays 8 A	24 V $\overline{\text{---}}$	88970131*
	6 digital (including 4 analogue)	4 solid state 0.5 A (including 1 PWM)	24 V $\overline{\text{---}}$	88970132
	6 digital	4 relays 8 A	100 $\rightarrow$ 240 V $\sim$	88970133*
	6 digital	4 relays 8 A	24 V $\sim$	88970134
XB26	16 digital (including 6 analogue)	10 relays (8 x 8 A relay and 2 x 5 A relay)	24 V $\overline{\text{---}}$	88970151
	16 digital (including 6 analogue)	10 solid state 0.5 A (including 4 PWM)	24 V $\overline{\text{---}}$	88970152
	16 digital	10 relays (8 x 8 A relay and 2 x 5 A relay)	100 $\rightarrow$ 240 V $\sim$	88970153
	16 digital	10 relays (8 x 8 A relay and 2 x 5 A relay)	24 V $\sim$	88970154
	16 digital (including 6 analogue)	10 relays (8 x 8 A relay and 2 x 5 A relay)	12 V $\overline{\text{---}}$	88970155

\*Available 2<sup>nd</sup> quarter of 2008

### General characteristics

See page 22, except:

Certifications	UL, CSA
----------------	---------

### Accessories

Type	Description	Code
M3 SOFT	Multilingual programming software containing specific library functions (CD-ROM)	88970111
PA	EEPROM memory cartridge	88970108
PA	3 m serial link cable: PC $\rightarrow$ Millenium 3	88970102
PA	3 m USB link cable: PC $\rightarrow$ Millenium 3	88970109
PA	Millenium 3 $\rightarrow$ Bluetooth interface (class A 10 m)	88970104

### Dimensions (mm)

XB10

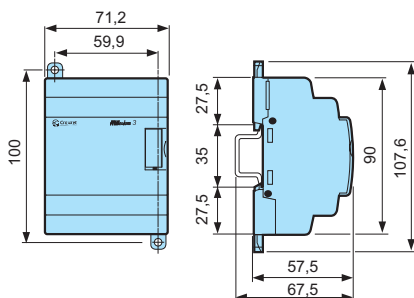

XB26

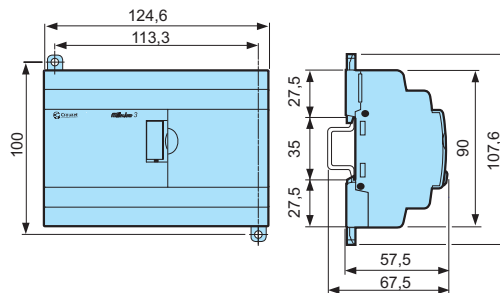

### Input / Output Connections

See Page 40-43 for details or to find instruction sheets visit: [www.millenium3.crouzet.com](http://www.millenium3.crouzet.com) in "Download"

For adapted products, see page 64-65

# Millenium 3 Standard

## → Sandwich communication extensions for XD10/XB10 & XD26/XB26

- Exchange of input/output state or of internal values via communication networks
- Power supply via the controller



### Part numbers

Type	Description	Supply	Code
XN03	Modbus RS-485 slave communication extension 4 words	Via the 24 V $\overline{\text{DC}}$ controller	88970250
XN06	Modbus RS-485 slave communication extension 8 words	Via the 24 V $\overline{\text{DC}}$ controller	88972250
XN05	Ethernet protocol TCP Modbus extension	Via the 24 V $\overline{\text{DC}}$ controller	88970270

### Characteristics of communication extensions

General characteristics	88970250 & 88972250	88970270
-------------------------	---------------------	----------

See page 22, except:

Certifications	UL, CSA, GL (UL, CSA: 88972250)	UL, CSA GL pending
Earthing	Yes, refer to the quick reference guide supplied with the product	Yes, refer to the quick reference guide supplied with the product
Operating temperature	-20 → +55°C (+40°C in a non-ventilated enclosure) in accordance with IEC/EN 60068-2-1 and IEC/EN 60068-2-2	0 → +55°C (+40°C in a non-ventilated enclosure) in accordance with IEC 60068-2-1 and IEC 60068-2-2
Cable length	Maximum length of the network: 1000 m (9600 Baud max, AWG26)	Maximum length between 2 controllers: 100 m

Communication parameters	88970250 & 88972250	88970270
--------------------------	---------------------	----------

Type of link	2 or 4-wire; RTU or ASCII	-
Transmission rate (Bauds)	1200, 2400, 4800, 9600, 19200, 28800, 38400, 57600	-
Parity	None; even; odd	-
Addressing	1 → 247	Static or dynamic

Characteristics of exchanges	88970250	88972250	88970270
------------------------------	----------	----------	----------

### Programming with Ladder language

Image of smart relay I/O	4	4	-
Status	1	1	-

### Programming with FBD language

Read	4	8	8
Read/Write	4	8	8
Clock words	4	12	4
Status words	1	1	1

### Dimensions (mm)

XN03 - XN05 - XN06

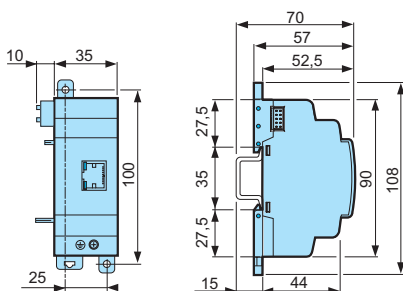

For adapted products, see page 64-65

## → Digital sandwich extension for XD10/XB10 and XD26/XB26

- Can be used to reach up to 50 inputs/outputs in conjunction with XR14 termination extensions
- Relay outputs one of which is a changeover relay



XE10

### Part numbers

Type	Input	Output	Supply	Code
XE10	6 digital	4 relays 5 A (1 of which is a changeover relay)	Via the 24 V $\square$ controller	88970321
	6 digital	4 relays 5 A (1 of which is a changeover relay)	100 → 240 V $\sim$	88970323
	6 digital	4 relays 5 A (1 of which is a changeover relay)	24 V $\sim$	88970324

### Dimensions (mm)

XE10

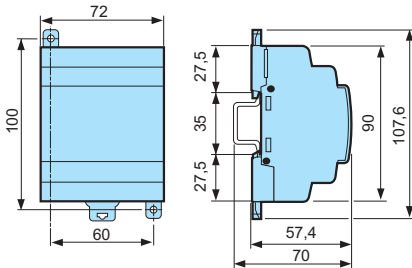

### Input / Output Connections

See Page 40-43 for details or to find instruction sheets visit: [www.millennium3.crouzet.com](http://www.millennium3.crouzet.com) in "Download"

For adapted products, see page page 64-65

# Millenium 3 Standard

## → Digital extension for XD10/XB10 and XD26/XB26

- Power supply via the controller at the same voltage as the inputs
- Number of inputs/outputs can be configured in accordance with your requirements



XR06

XR10

XR14

### Part numbers

Type	Input	Output	Supply	Code
XR06	4 digital	2 relays 8 A	Via the 24 V $\overline{\text{---}}$ controller	88970211
	4 digital	2 relays 8 A	Via the 100 $\rightarrow$ 240 V $\sim$ controller	88970213
	4 digital	2 relays 8 A	Via the 24 V $\sim$ controller	88970214
	4 digital	2 relays 8 A	Via the 12 V $\overline{\text{---}}$ controller	88970215
XR10	6 digital	4 relays 8 A	Via the 24 V $\overline{\text{---}}$ controller	88970221
	6 digital	4 relays 8 A	Via the 100 $\rightarrow$ 240 V $\sim$ controller	88970223
	6 digital	4 relays 8 A	Via the 24 V $\sim$ controller	88970224
	6 digital	4 relays 8 A	Via the 12 V $\overline{\text{---}}$ controller	88970225
XR14	8 digital	6 relays (4 x 8 A relay and 2 x 5 A relay)	Via the 24 V $\overline{\text{---}}$ controller	88970231
	8 digital	6 relays (4 x 8 A relay and 2 x 5 A relay)	Via the 100 $\rightarrow$ 240 V $\sim$ controller	88970233
	8 digital	6 relays (4 x 8 A relay and 2 x 5 A relay)	Via the 24 V $\sim$ controller	88970234
	8 digital	6 relays (4 x 8 A relay and 2 x 5 A relay)	Via the 12 V $\overline{\text{---}}$ controller	88970235

### Dimensions (mm)

XR06

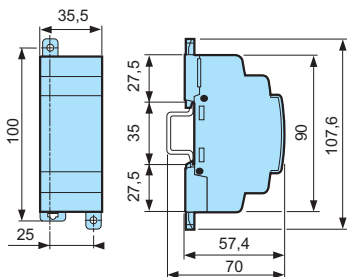

XR10 - XR14

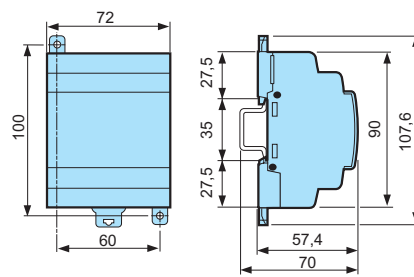

### Input / Output Connections

See Page 40-43 for details or to find instruction sheets visit: [www.millenium3.crouzet.com](http://www.millenium3.crouzet.com) in "Download"

## → Analogue extension for XD10/XB10 and XD26/XB26

- Direct connection of analogue 0-10 V or 0-20 mA or Pt 100 inputs (10 bits) can be configured using the M3 SOFT
- 2 analogue 0-10 V or PWM outputs (10 bits) can be configured using the M3 SOFT software
- Ramp can be parameterised for outputs used as 0-10 V outputs
- Power supply via the controller



XA04

### Part numbers

Type	Input	Output	Supply	Code
XA04	1 analogue (0-10 V / 0-20 mA), 1 analogue (0-10 V / 0-20 mA / Pt100)	2 analogue (0-10 V) / PWM	Via the 24 V $\overline{\text{---}}$ controller	88970241

For adapted products, see page page 64-65

## Characteristics of analogue extension 88970241

### General characteristics of analogue extension 88970241

#### See page 22, except:

Certifications	UL, CSA GL (pending)
Earthing	Yes, refer to the quick reference guide supplied with the product

### Analogue inputs

Inputs used as analogue inputs	0-10 V	0-20 mA	Pt 100
Input	IP and IQ	IP and IQ	IQ
Input range	0 → 10 V ---	0 → 20 mA	-25 → 125°C
Input impedance	≥ 18 kΩ	246 Ω	-
Maximum non destructive current/voltage	30 V	30 mA	-
Value of LSB	9.8 mV	20 μA	0.15°C
Input type	Common mode	Common mode	Pt 100 probe - IEC 751 - 3-wire
Resolution	10 bits	10 bits	10 bits
Conversion time	Module cycle time	Module cycle time	Module cycle time
Accuracy at 25°C	± 1%	± 1%	±1.5°C
Accuracy at 55°C	± 1%	± 1%	±1.5°C
Isolation between analogue channel and power supply	None	None	None
Longueur câble	10 m maximum, with shielded cable (sensor not isolated)	10 m maximum, with shielded cable (sensor not isolated)	10 m maximum, with shielded cable (sensor not isolated)
Protection against polarity inversions	Command ignored	Command ignored	Command ignored

### Analogue outputs

Range output	0 → 10 V
Input type	Resistive
Max. load	10 mA
Value of LSB	10 mV
Resolution	10 bits
Conversion time	Controller cycle time
Accuracy at 25°C	±1% of full scale
Accuracy at 55°C	±1% of full scale
Repeat accuracy at 55 °C	± 1%
Isolation between analogue channel and power supply	None
Cable length	10 metres maximum, with shielded cable (sensor not isolated)
Protection against polarity inversions	Yes

### PWM

Range output	V power supply
Max. load	≥ 1.2 kΩ (I ≤ 20 mA)
PWM cyclic ratio	1024 steps
Frequency	78 Hz, 312.5 Hz, 666.6 Hz, 1000 Hz, 1250 Hz, 1428 Hz, 1666 Hz, 2000 Hz
Accuracy	1% across the entire temperature range for PWM ratios from 5% to 95%
Built-in protections	Against overvoltages: Yes

## Dimensions (mm)

### XA04

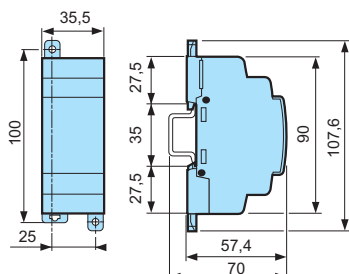

## Input / Output Connections

See Page 40-43 for details or to find instruction sheets visit: [www.millennium3.crouzet.com](http://www.millennium3.crouzet.com) in "Download"

For adapted products, see page page 64-65

# Millenium 3 Standard

## → Modem communication plug and play solutions

- For remote control of your application
- Automatic notification of alarms via SMS (GSM Modem) / email or on a PC with M3 ALARM software.
- Millenium 3 program can be downloaded, modified and sent
- Input and output states, as well as all program values, can be polled and controlled remotely
- 2 types of pre-configured ready-to-use modem:
  - STN modem for wired transmission networks
  - GSM modem for wireless communication



M3MOD



STN



GSM

### Part numbers

Type	Description	Supply	Code
M3MOD	Modem communication interface	12-24 V ---	88970117
STN	STN modem	12-24 V ---	88970118
GSM	GSM modem 850/900/1800/1900 MHz	12-24 V ---	88970119

### Accessories

Type	Description	Code
PA	1.80 m serial link cable: DB9/DB9	88970123
M3 ALARM	Alarm management software (CD-ROM)	88970116

### Characteristics of the communication Modem system

General characteristics of the modem communication	88970117	88970118	88970119
--	----------	----------	----------

#### See page 22, except:

Certifications	UL, CSA	UL, CSA	UL, CSA, CE, FCC, IC, PTCRB, R&TTE
----------------	---------	---------	------------------------------------

Power supply	88970117	88970118	88970119
--------------	----------	----------	----------

Nominal voltage (V)	12 → 24 V ---	12 → 24 V ---	12 → 24 V ---
Operating limits	-13% / + 20% or 10 → 28.8 V ---	-13% / + 5% or 10 → 30 V ---	-54% / + 33% or 5.5 → 32 V ---
Ripple	5% max.	-	-
Nominal current under 12 V DC	30 mA	140 mA	165 mA
Nominal current under 24 V DC	30 mA	70 mA	87 mA
Peak current on energisation	550 mA	9600 mA	2100 mA at 5.5 V
Max. absorbed power	1.1 W	-	2.1 W
Immunity from micro power cuts	1 ms, repetition 20 times	No	-
Protection against polarity inversions	Yes	-	No
Fuse protection	1 A fuse	-	With fuse 2.5 A

### Characteristics of the "COM-M3" link with the controller

Type of connector	Specific Millenium
Type of link	Specific Millenium communication protocol
Compatibility	Only with Millenium controllers version ≥ V2.1
Isolation of "Com-M3" connector from the "Com-M" connector	Via optocoupler ~ 1780 V
Isolation of "Com-M3" connector from the ± supply terminals	Via optocoupler ~ 1780 V

### Characteristics of the "COM-M3" link with the modem

Type of connector	Specific Millenium
Type of link with Modem connector cable	RS 232 serial (supplied with the communication interface)
Compatibility	Only with Millenium controllers version ≥ V2.1
Analogue RTC modem compatibility	AT commands
GSM modem compatibility	AT commands
Isolation of "Com-M" connector from the Modem	Via link cable to Modem (supplied)
Isolation of "Com-M" connector from the ± supply terminals	Via link cable to Modem (supplied)

**Data characteristics**

Data saved by the interface	Up to 28 messages 1 to 10 recipients (telephone numbers and/or e-mail addresses) per message Time-stamping of messages to be sent (date and time) Saving of values on triggering of the message activation condition (digital and numerical values)
Backup of data to be sent	Flash memory

**Functions available depending on the hardware architecture and/or type of SIM card**

Functions	Remote station device				
	Analogue PSTN modem	GSM modem			
		Type of SIM card			
		Data	Data voice		Voice
		Data n°	Voice n°		
Send alarm/receive instructions with GSM telephone					
Send alarm/receive instructions with PC running "M3 Alarm" software <sup>(1)</sup>					
Transfer program Update firmware Monitoring <sup>(1)</sup>					
Send alarm to e-mail address					

Functions available      Functions not available

**Nota:** Instructions can not be transmitted by e-mail

<sup>(1)</sup> When using a GSM Modem on the PC side, the SIM card must have a DATA number.

**Comments**

- 88970117 : supplied with connecting cable between M3MOD and Modem (Millenium 3 connector to sub DB9)
- 88970118 : supplied with configuration CD-ROM and telephone cable
- 88970119 : supplied with an antenna, a power cable, and DIN Rail mounting kit

**Dimensions (mm)**

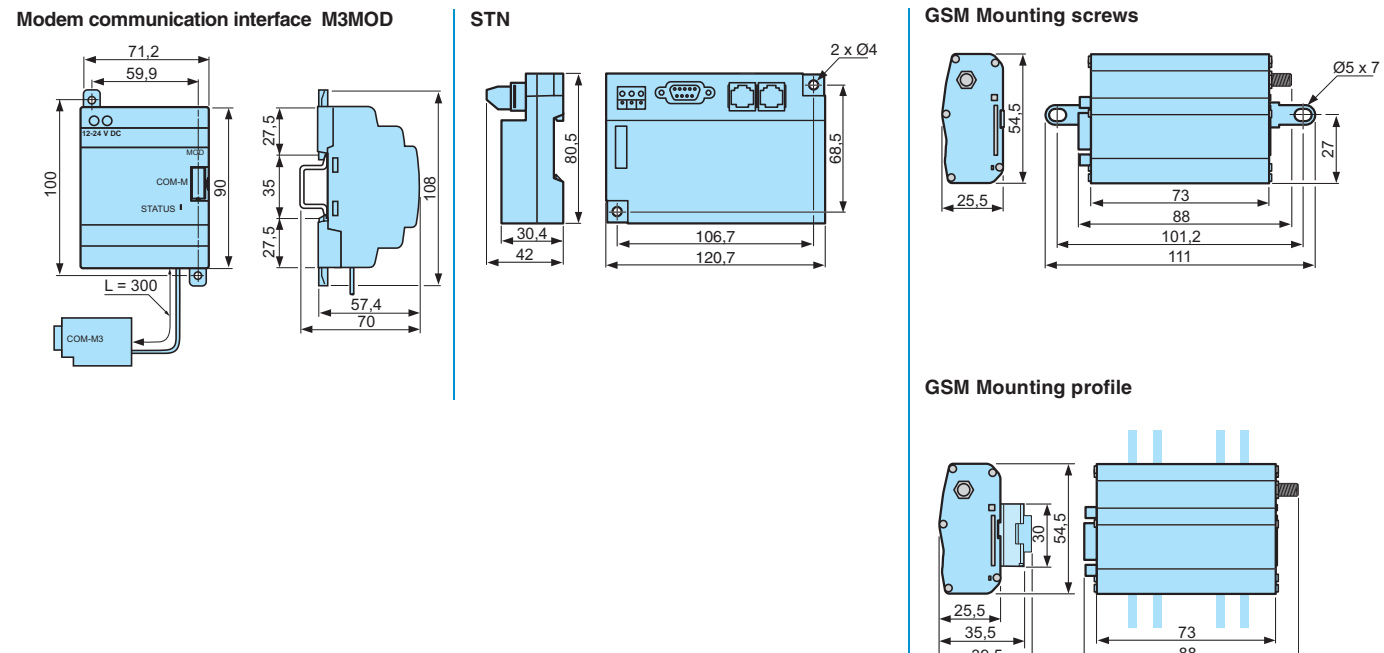

**Input / Output Connections**

To find instruction sheets please visit: [www.millenium3.crouzet.com](http://www.millenium3.crouzet.com) in "Download"

# Millenium 3 Standard

## → I/O wiring

### Inputs 12 V $\overline{\text{---}}$ , 24 V $\overline{\text{---}}$

**Bases :** CD12, CD20, CB12, CB20, XD10, XD26, XB10, XB26

**Extensions :** XE10, XR06, XR10, XR14

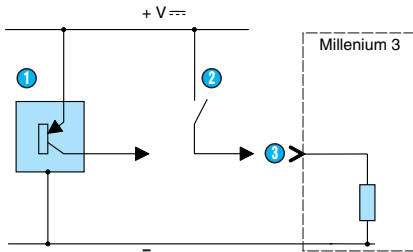

- ① 3-wire PNP sensor
- ② Contact
- ③ Digital input

**Bases :** CD12, CD20, CB12, CB20, XD10, XD26, XB10, XB26

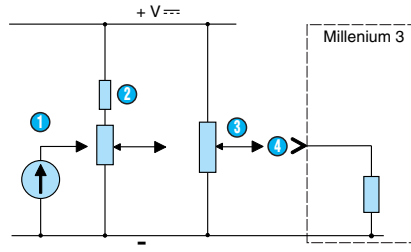

- ① 0-10 V (input set to 0-10 V)
- ② Potentiometer type mounting (input set to 0-10 V)
- ③ Potentiometer (input set as a potentiometer)
- ④ Analogue input

**Bases :** CD12, CD20, CB12, CB20, XD10, XD26, XB10, XB26

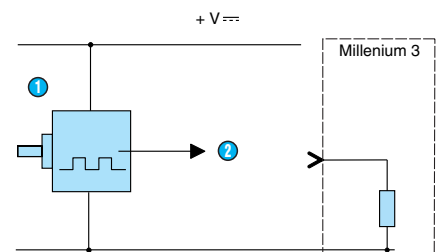

- ① Encoder
- ② High-speed digital input

### Inputs 100-240 V $\sim$ , 24 V $\sim$

**Bases :** CD12, CD20, CB12, CB20, XD10, XD26, XB10, XB26

**Extensions :** XE10, XR06, XR10, XR14

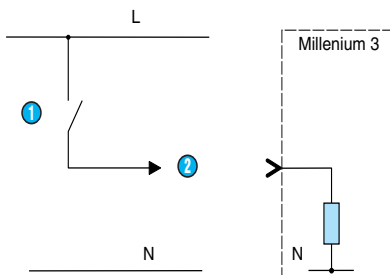

- ① Contact
- ② Digital input

### Analogue inputs

**Extension :** XA04

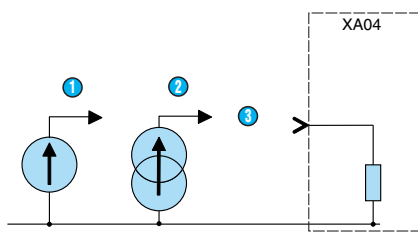

- ① 0-10 V
- ② 0-20 mA
- ③ Analogue input

**Extension :** XA04

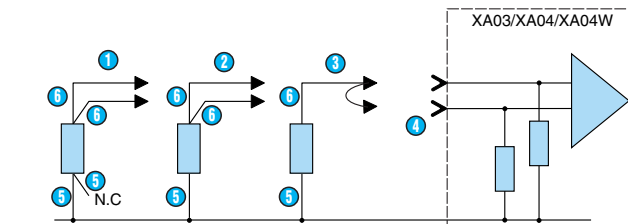

- ① Pt100 4-wire
- ② Pt100 3-wire
- ③ Pt100 2-wire
- ④ Analogue input
- ⑤ White
- ⑥ Red



## Relay outputs

**Bases :** CD12, CD20, CB12, CB20, XD10, XD26, XB10, XB26

**Extensions :** XE10, XR06, XR10, XR14

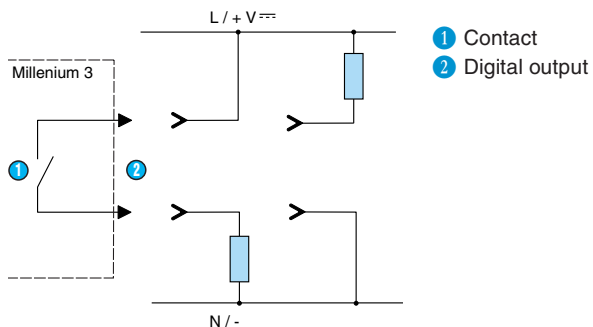

## Solid state outputs

**Bases :** CD12, CD20, CB12, CB20, XD10, XD26, XB10, XB26

**Extensions :** XA04

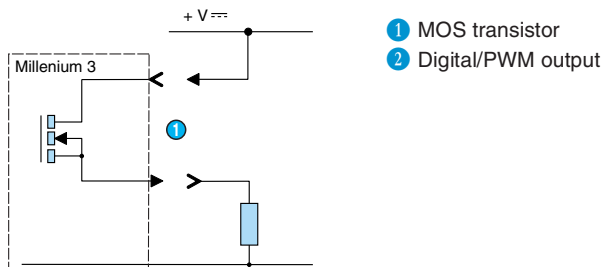

## Analogue outputs

**Extension :** XA04

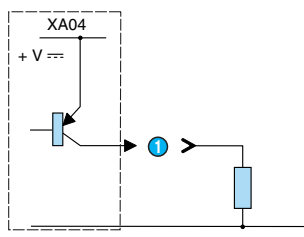

1 PWM output

**Extension :** XA04

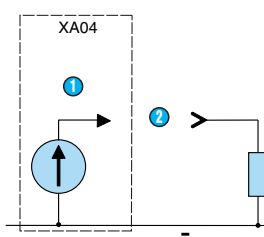

1 0-10 V  
2 Analogue output

# Millenium 3 Standard

## → Input/output installations: Bases

### "Compact" range : CD12, CD20, CB12, CB20

#### Inputs

##### CD12, CB12

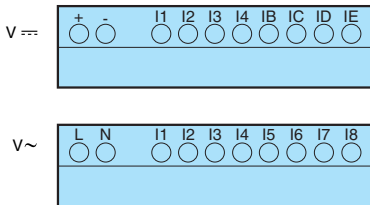

##### CD20, CB20

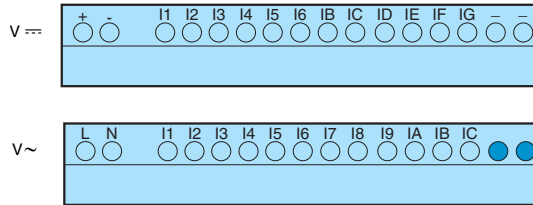

#### Relay outputs

##### CD12, CB12

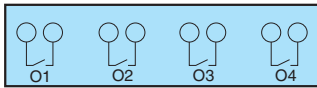

##### CD20, CB20

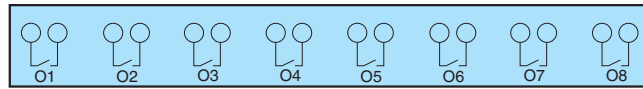

#### Solid state outputs

##### CD12, CB12

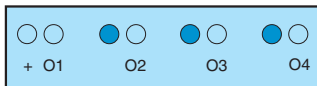

##### CD20

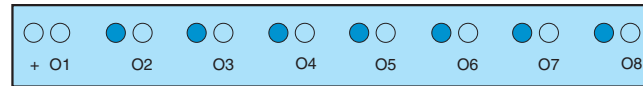

### "Expandable" range : XD10, XD26, XB10, XB26

#### Inputs

##### XD10, XB10

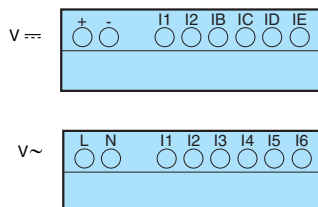

##### XD26, XB26

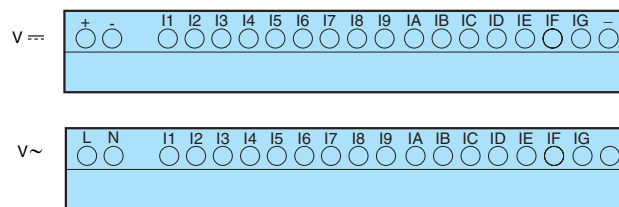

#### Relay outputs

##### XD10, XB10

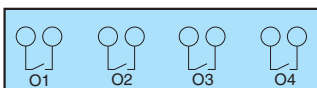

##### XD26, XB26

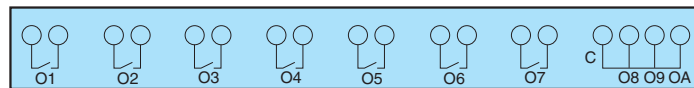

#### Solid state outputs

##### XD10

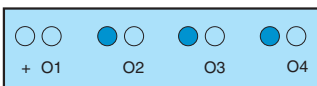

##### XD26



## → Input/output installations: Extensions

### "Sandwich" communication extensions : XN03, XN05, XN06

XN03, XN06

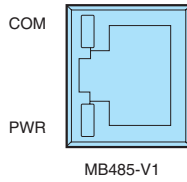

XN05

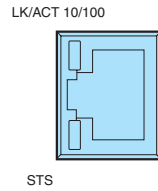

### Digital "Sandwich" extensions : XE10

#### Inputs

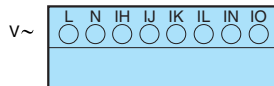
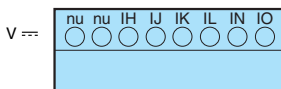

#### Relay outputs

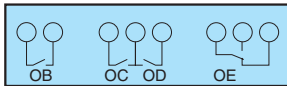

### Digital termination extensions : XR06, XR10, XR14

#### Inputs

XR06

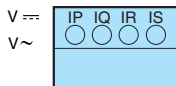

XR10



XR14

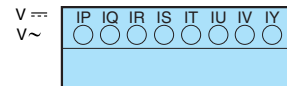

#### Relay outputs

XR06

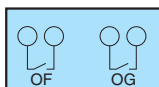

XR10

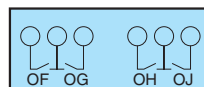

XR14

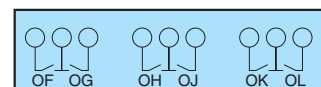

### Analogue termination extension : XA04

#### Inputs

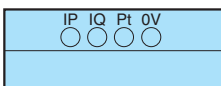

#### Outputs

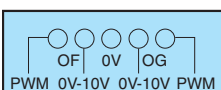

## Millenium 3 accessories

### → Programming tools and software

- Millenium 3 software: multilingual software, intuitive operation
- Memory card for loading the application and updating the on-board software (firmware)



Millenium 3 Software



Memory cartridge

#### Part numbers

Type	Description	Code
M3 SOFT	Multilingual programming software containing specific library functions (CD-ROM)	88970111*
M3 ALARM	Alarm management software (CD-ROM)	88970116**
PA	EEPROM memory cartridge	88970108

#### Comments

\* Compatible with Windows 2000, NT 4.0 SP5, XP 300 MHz Pentium (Pentium II 600 MHz recommended) 128 MB RAM (256 MB recommended)  
 \*\* Used with the modem communication interface (M3MOD)

### → Connection accessories

- Direct connection to all types of PC: serial, USB
- Wireless "Bluetooth" connection for applications that are complex in terms of access



Serial cable



USB cable



Bluetooth interface

#### Part numbers

Type	Description	Code
PA	3 m serial link cable: PC → Millenium 3	88970102
	3 m USB link cable: PC → Millenium 3	88970109
	Millenium 3 → Bluetooth interface (class A 10 m)	88970104
	Bluetooth → USB adaptor (class A 10 m)	88970110
	1.80 m serial link cable: DB9/DB9	88970123

### → Removable connectors

- Millenium 3 can be removed for speedy replacement of the controller
- Cable connection memory to exclude the risk of errors on reconnection



Removable connector kit

#### Part numbers

Type	Description	Code
MA	Removable kit for CD12 or CB12	88970310
	Removable kit for CD20 or CB20	88970311
	Removable kit for XD26 or XB26	88970312

#### General characteristics

Screw terminals connection capacity	Cable diameter 0.14 → 2.5 mm <sup>2</sup> AWG 22 - 12
Max. current	12 A

# Millenium 3 accessories

## → Faceplates

- IP67: sealing on front panel, Panel-mounting of the Millenium 3 .
- IP40: Direct access to the front of the controller, Possibility of Labelling (marking laser)



IP67



IP40

### Part numbers

Type	Description	Code
MA	IP67 sealed faceplate for the following products: - XD10 or CD12	89750160
	IP67 sealed faceplate for the following products: - XD10 + XR06 or XN03 or XN05 or XA04 - CD20 or XD26 - XD10 + XN03 or XN05 + XR06 or XA04 - XD10 + XR10 or 14	89750161
	IP67 sealed faceplate for the following products: - XD26 + XR06 or XN03 or XN05 or XA04 - XD10 + XN03 or XA04 + XR10 or 14 - XD10 + XE10 + XR06 or XA04 - XD26 + XN03 or XN05 + XR06 or XA04 - XD26 + XR10 or 14 - XD10 + XE10 + XR10 or 14 - XD26 + XE10 + XR06 or XA04 - XD26 + XN03 or XN05 + XR10 or 14	89750162
	IP40 faceplate: CD12 or XD10	88970809
	IP40 faceplate: CD20 or XD26	88970810

### Dimensions (mm)

#### IP67

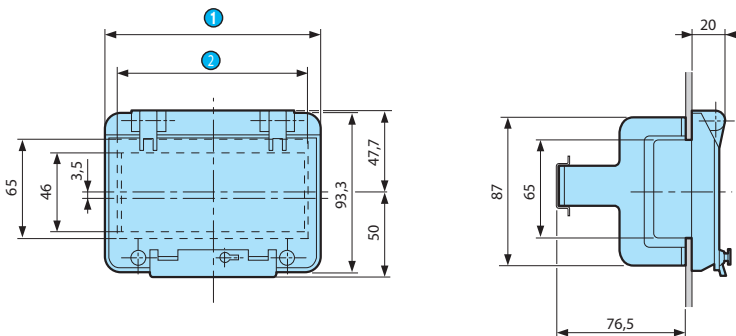

- ① 88750160 = 91  
88750161 = 162  
88750162 = 257.4
- ② 88750160 = 76.5  
88750161 = 147.5  
88750162 = 248.5

#### IP40

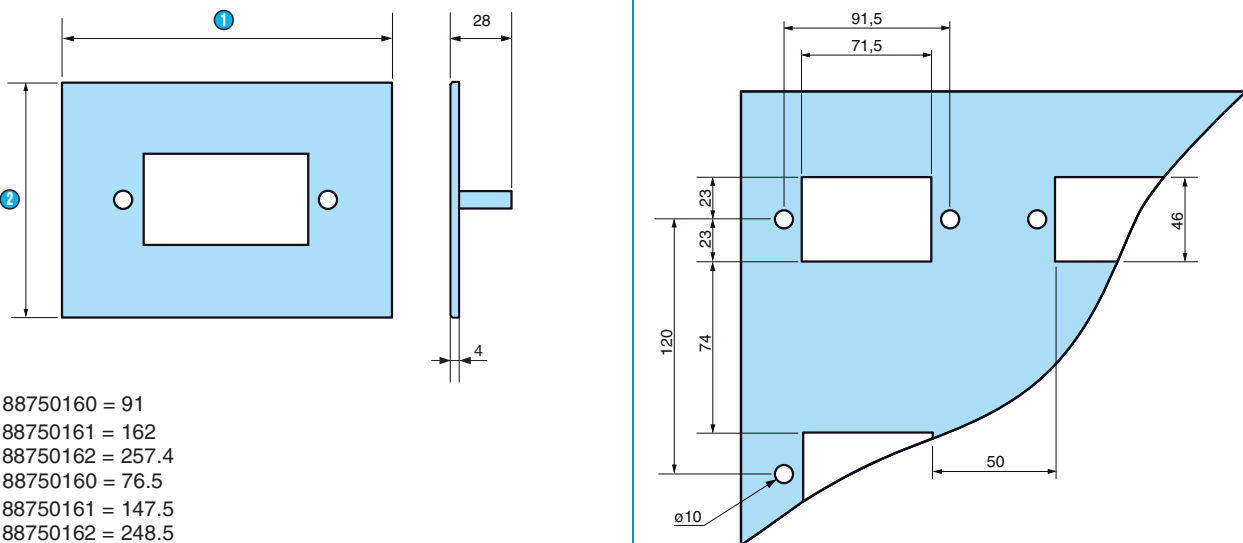

- ① 88750160 = 91  
88750161 = 162  
88750162 = 257.4
- ② 88750160 = 76.5  
88750161 = 147.5  
88750162 = 248.5

Millenium 3 Standard

## Millenium 3 accessories

### → Remote LCD alphanumeric displays (Modbus communication)

- Set and parameterise your application data in advance
- Backlit LCD screen (72 x 20 mm) with 4 lines of 20 characters and keypad with 8 keys, 4 of which can be renamed
  - Three-colour screen: 3 colours green/orange/red
  - Monochrome screen: Monochrome green
- Size of characters can be configured to optimise readability
- Communicates with the Millenium 3 via Modbus extension XN06 or XN03
- The Runtime kit includes:
  - 1 three-colour or monochrome LCD screen
  - 1 Modbus extension XN06
  - 1 RS485 cable
- The Programming kit includes:
  - 1 three-colour or monochrome LCD screen
  - 1 Modbus extension XN06
  - 1 RS485 cable
  - 1 programming software package for the display with a compatible RS232 cable (88950105)
- Display is used as a Master (or can be configured as a Slave)



Three-colour screen



Monochrome screen

#### Part numbers

Type	Designation	Code
RD	Runtime kit with three-colour screen	88970421
	Runtime kit with monochrome screen	88970422
	Programming kit with monochrome screen	88970844
	Programming kit with three-colour screen	88970849

#### General characteristics

Environmental characteristics	
Certifications	UL, CSA
Conformity to standards	IEC 61131-2, IEC 60068-2-6, IEC 60068-2-27, CSA n°14
Operating temperature	0 → +55°C
Storage temperature	-20 → +60°C
Relative humidity no condensation acc. to IEC 60068-2-3	95% max.
Protection rating	In accordance with IEC/EN60529 IP65 on front panel (UL type 4, 4X) IP20 on rear panel
Dimensions (l x h x p)	132 x 74 x 31 mm
Panel cut-out	119.4 x 63 mm
Electrical characteristics	
Supply voltage	24 V $\overline{\text{---}}$
Voltage limits	18 → 30 V $\overline{\text{---}}$
Ripple	5% max.
Consumption	200 mA max.
Mechanical characteristics	
Mounting	Flush-mounted, fixed with 2 spring clips supplied pressure-mounted for panel thicknesses from 1.5 to 6 mm
Display protection	Polyester
Keyboard material	Polyester autotex UV
Connection	Removable 3-pin screw terminal
Connection capacity	1.5 mm <sup>2</sup>
Connection	Serial via 25-pin female SUB D connector
Display characteristics	
Description	Backlit LCD 4 lines of 20 characters to 1 line of 5 characters (configurable) Communication status indicated by LED (three-colour screen) Alarm indicators and function keys (three-colour screen) Master mode display or Slave mode

#### Comments

These kits are used in conjunction with expandable Millenium 3 products (XD10 and XD26) 24 V  $\overline{\text{---}}$ . To be ordered separately. The XN06 exchanges more words (8) than the XN03 (4) but with different addresses

#### Dimensions (mm)

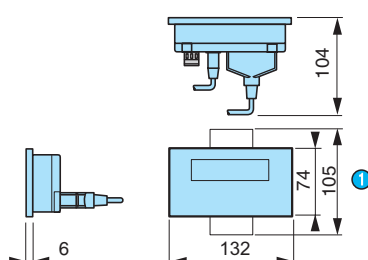

① Dimensions (mm) including spring clips

# Millenium 3 accessories

## → Remote LCD displays/keypads

- Direct link with Millenium 3 via cable
- Set and parameterise your application data in advance
- Backlit LCD screen with 4 lines of 18 characters and keypad with 6 keys or 10 keys and 4 LEDs
- Direct communication with the Millenium 3 via the programming port
- Plug and play: No additional software (the function keys and LEDs are controlled by the Millenium 3 SOFT Slin/Slout FBD functions)
- Check bit for controlling communication
- Universal screen compatible with any Millenium 3 logic controller (standard, budget, expandable, bare board, resin board)



Remote LCD screen / keypad



Remote LCD screen / keypad + 4 function buttons + 4 LEDs

### Part numbers

Type	Designation	Code
RD	Remote LCD screen/keypad	88970410
	Kit with remote LCD screen/keypad + 3 m cable (88970102)	88970412
	Remote LCD screen/keypad + 4 function keys + 4 LEDs	88970411
	Kit with remote LCD screen/keypad + 4 function keys + 4 LEDs + 3 m cable (88970102)	88970413

### Accessories

Type	Description	Code
MA	IP65 protective membrane (in accordance with DIN 40050 and EN60529)	88970414
PA	3 m serial link cable: PC → Millenium 3	88970102
PA	1.80 m serial link cable: DB9/DB9	88970123

### General characteristics

See page 22, except for the characteristics below:

#### Environmental characteristics

Certifications	UL, CSA (pending)
Dimensions (l x h x p)	96.6 x 72.8 x 63 mm
Panel cut-out	92 x 68 mm
Protection rating	IP54 on front panel IP20 on rear panel

#### Electrical characteristics

Supply voltage	24 V $\overline{\text{---}}$
Voltage limits	- 20%/+ 25% or 19.2 → 30 V $\overline{\text{---}}$ (including ripple)
Consumption	1.5 W (88970410) 2 W (88970411)
Protection against polarity inversions	Without effect

#### Mechanical characteristics

Mounting	Flush-mounted, fixed with 2 clips (supplied)
Display protection	Polyester
Keyboard material	Polyester
Housing material	Self-extinguishing UL94V1
Connection	Removable 2-pin terminal
Connection	Serial via 9-pin male SUB D connector
Cable length	3 m maximum

#### Display characteristics

Cycle time	20 ms + 2 Millenium 3 Controller cycles (88970410 and 88970412) 50 ms + 10 Millenium 3 Controller cycles (88970411 and 88970413)
------------	---

#### Comments

If using a remote display/keypad with a Millenium 3 resin board version, order the DB9/DB9 serial link cable separately (Part no. 88970123)

### Dimensions (mm)

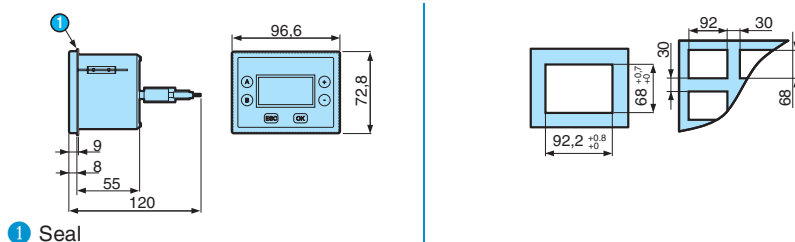

1 Seal

## Millenium 3 accessories

### → Remote LED display - Input 0-10 V

- Set your application data in advance
- Display (36 x 72) with 4 x 14 mm red digits
- Configurable display range
- 0-10 V input
- IP65 degree of protection on front panel



Remote LED display

#### Part numbers

Type	Description	Supply	Code
RD	Display with 4 x 14 mm red digits	24 V $\overline{\text{---}}$	88950400

#### General characteristics

##### Environmental characteristics

Certifications	UL
Conformity with the EMC directive	EN 61000-6-4, EN 61010-1
Protection rating	In accordance with IEC/EN 60529: IP65 on front panel IP20 on rear
Operating temperature	-10 → +55°C
Dimensions (l x h x p)	36 x 72 x 61 mm
Panel cut-out	71 x 29 mm

##### Electrical characteristics

Supply	24 V $\overline{\text{---}}$
Tolerance	± 10%
Consumption	<1 W
Input voltage	0 → 10 V $\overline{\text{---}}$

##### Mechanical characteristics

Mounting	Flush-mounted
Connection	Terminal block

##### Display characteristics

Height of digits	14 mm
Number of digits	4
Colour	Red
Range	-1999...5999 with selectable decimal point
Device accuracy (full scale)	≤ ± 0.3% of interval

##### Comments

\* Can be connected directly to an analogue output or via a PWM/0-10 V converter

#### Dimensions (mm)

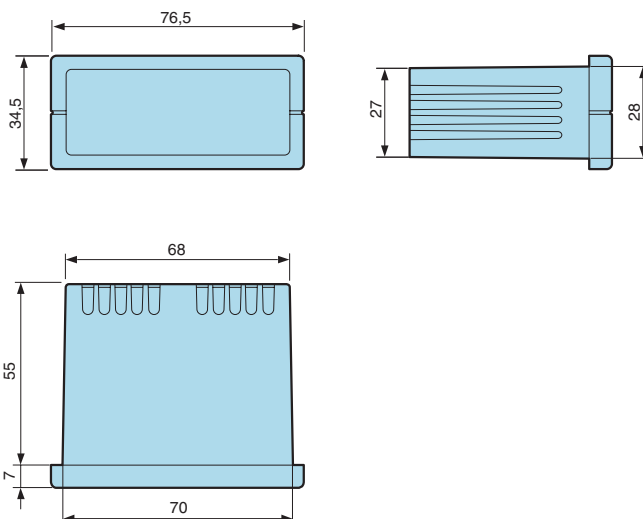



## → Potentiometer Ø 22 mm

- Direct-read potentiometer (controlled externally) Ø 22 mm
- IP65 degree of protection on front panel
- Directly compatible with the "Potentiometer" parameter of an analogue input on the Millennium 3



Potentiometer

### Part numbers

Type	Description	Alimentation	Supply
EP	External potentiometer for value adjustment	30 V $\overline{\text{---}}$ max	88950109

### General characteristics

#### Environmental characteristics

Protection rating	In accordance with IEC/EN 60529: IP65 on front panel IP10 on terminal block
Operating temperature	-20 → +60°C
Storage temperature	-20 → +70°C

#### Electrical characteristics

Ohmic value	4700 $\Omega$
Tolerance	$\pm 20\%$
Power	150 mW

#### Mechanical characteristics

Screw terminals connection capacity	1 x 4 mm <sup>2</sup> rigid 1 x 2.5 mm <sup>2</sup> flexible
-------------------------------------	---

### Dimensions (mm)

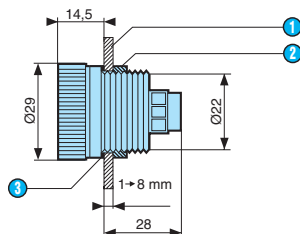

- ① Panel
- ② Nut
- ③ Seal

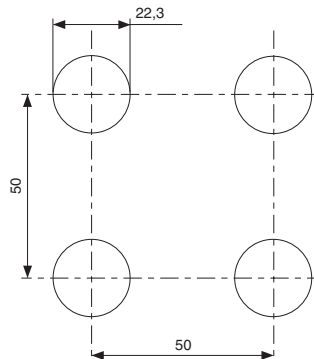

### Connections

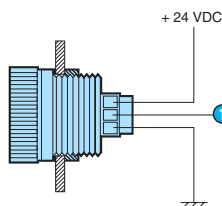

- ① Analogue input

# Millenium 3 accessories

## → Signal converters

- Current/voltage conversion of Millenium 3 input signals
- PWM/voltage conversion of Millenium 3 output signals



Current/voltage converter

### Part numbers

Type	Description	Input	Output	Code
AC	0-20 mA/0-10 V input converter	4	4	88950108
	PWM/0-10 V output converter	1	1	88950112

### General characteristics

88950108

88950112

#### Environmental characteristics

Environmental characteristics	88950108	88950112
Certifications	UL	UL
Protection rating	In accordance with IEC/EN 60529: IP20 terminal block IP50 casing	In accordance with IEC/EN 60529: IP20
Operating temperature	-20° → +85°C	-20° → +55°C
Storage temperature	-40° → +85°C	-25° → +70°C

#### Electrical characteristics

Electrical characteristics	88950108	88950112
Supply	-	24 V $\overline{\text{---}}$ (+10% / -15%)
Input current	0-20 mA	-
Output voltage	0-10 V $\pm$ 5%	0-10 V $\pm$ 5%
Impedance	500 $\Omega$ (input)	250 $\Omega$ (maximum load)
Max. current	40 mA	40 mA (output)
Input PWM	-	24 V $\overline{\text{---}}$ (+20% / - 15%, 120 Hz)
Short-circuit protection	-	Yes
Protection against polarity inversions	-	Yes (>10 s)
Absorbed power	0.8 W	1.3 W
Conversion time	-	440 ms (max) : 0 → 100% & 100% → 0

#### Mechanical characteristics

Mechanical characteristics	88950108	88950112
Cable length	-	< 10 m with shielded cable

### Dimensions (mm)

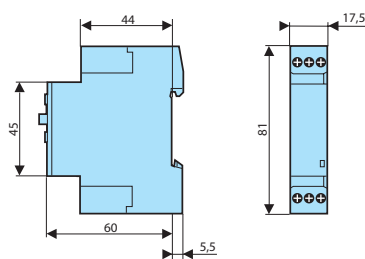

### Connections

#### 0-20 mA/0-10 V input converter

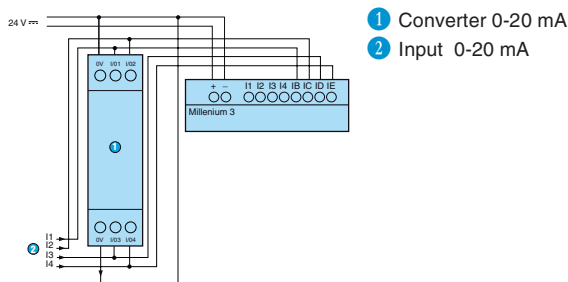

#### PWM/0-10 V output converter

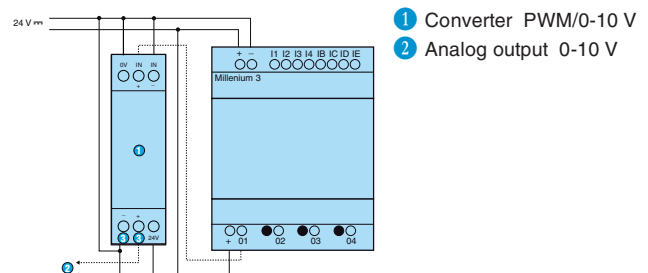

## → Temperature converters

- Compatible with Millenium 3 analogue inputs
- Can be used to diversify the type of sensors for analogue inputs (See page 54-55)



Temperature converter

### Part numbers

Type	Description	Input	Input range	Output	Code
AC	Converter	Pt 1000 3-wire	-20 → +150°C	0-10 V	88950150
	Converter	Pt 100 3-wire	-40 → +40°C	0-10 V	88950151
	Converter	Pt 100 3-wire	0 → +100°C	0-10 V	88950152
	Converter	Pt 100 3-wire	0 → +250°C	0-10 V	88950153
	Converter	Thermocouple J	0 → +300°C	0-10 V	88950154
	Converter	Thermocouple K	0 → +600°C	0-10 V	88950155

### General characteristics

#### Environmental characteristics

Certifications	UL
Protection rating	In accordance with IEC/EN 60529: IP40 on front panel IP20 on terminal block
Operating temperature	-10 → +55°C

#### Electrical characteristics

Supply	24 V $\overline{\text{---}}$
Operating limits	$\pm 10\%$ or 21.6 $\overline{\text{---}}$ → 26.4 V $\overline{\text{---}}$
Max. Output power	< 1 W
Output voltage	0 → 10 V $\overline{\text{---}}$
Device accuracy (full scale)	$\pm 1\%$

### Dimensions (mm)

#### Temperature converter

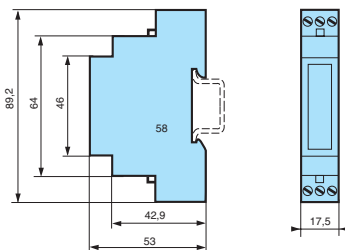

### Connections

#### Temperature converter

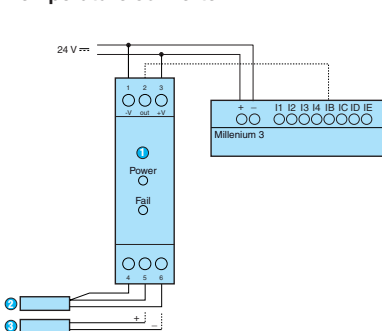

- 1 Temperature converter: Pt100/Pt1000 TC J/K
- 2 Pt100 3-wire
- 3 Thermocouple

# Millenium 3 accessories

## → Analogue pressure transmitters 4-20 mA

- Dry, robust pressure transmitter
- Ceramic variable capacitance sensing element
- Withstands high static and dynamic overload pressures
- Standard Ranges between 0.25 bar and 100 bar (Abs / Rel)
- Fully Factory Calibrated & Temperature Compensated
- Viton Media Ring most suitable for all generic process media
- Wide Temperature Range (-40°C / 125 °C)
- 4 dedicated function blocks (Pressure gain, Flow, Level, HL Switch) included in the M3 SOFT



Pressure transmitter

### Part numbers

Measurement range	Gauge*	Absolute**
0 → 0.25 bar	89210001	
0 → 1 bar	89210002	89210007
0 → 2.5 bar	89210003	89210008
0 → 10 bar	89210004	89210009
0 → 25 bar	89210005	89210010
0 → 60 bar	89210006	
0 → 100 bar		89210011

\*in relation to atmospheric pressure

\*\*in relation to the vacuum

### Accessories

Type	Designation	Code
M3 SOFT	Multilingual programming software containing specific library functions (CD-ROM)	88970111

### Comments

Adjustment range (bar)	0 → 0.25	0 → 1	0 → 2.5	0 → 10	0 → 25	0 → 60	0 → 100
Acceptable overpressure (bar)	1.25	5	12.5	30	75	90	150
Burst pressure (bar)	2.5	10	25	50	125	180	300
Pressure Port & outer housing	Inox 1.4305						
Connection of pressure	G 1/4 M Manometer DIN 16288						
Connector Housing	Polyamide (PA)						
Standard Internal Primary Media Ring Material	Viton -17°C → 125°C						
Electrical connections	L-Connector DIN 43650, PG11, IP65						
Conformity to standards	89/336/EWG interference emission and immunity see EN 61 326						

### General characteristics

Supply	12 → 32 V ---
Output signal	4 → 20 mA / 2 wire
Maximum loop resistance	50 → 1000 Ω - Rmax = (V power supply - 12) / 0.02 A
Response time	< 5 ms, 63% of full scale

### Electrical characteristics

Operating temperature	-30 → 20 °C	20 → 80 °C	80 → 100 °C
Linearity	± 0.2% of full scale	± 0.1% of full scale	± 0.2% of full scale
Stability	< 1% / year	± 0.2% / year	< 1% / year
Total Error Band (including Repeat Hysteresis)	± 2% max.	± 1% max.	± 2% max.

### Dimensions (mm)

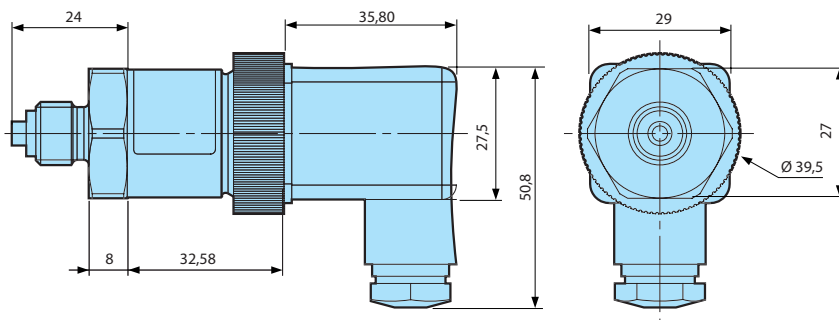

Nb: To envisage a disc in agreement with the type of connection of pressure

## Connections

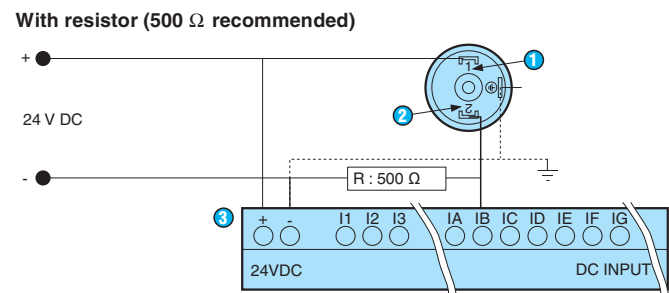

+ Simple & economic solution

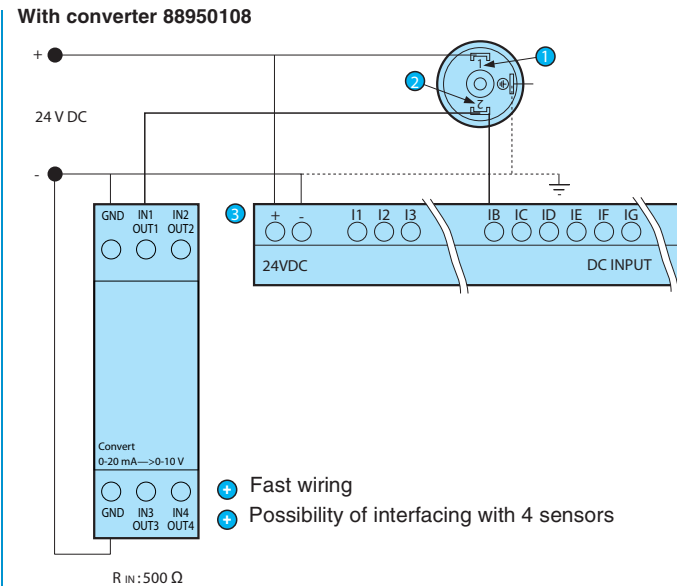

+ Fast wiring  
+ Possibility of interfacing with 4 sensors

- 1 Terminal +
- 2 Terminal -
- 3 M3 - 24 V

- 1 Terminal +
- 2 Terminal -
- 3 M3 - 24 V

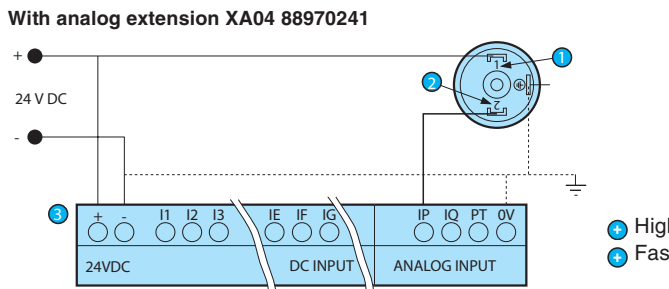

+ High resolution  
+ Fast wiring

- 1 Terminal +
- 2 Terminal -
- 3 M3 - 24 V Extendable versions

## Product adaptations



- Internal Primary Media Seal Ring Material
- Other Pressure Range

## Dedicated function blocks

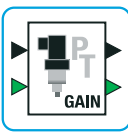

**Pressure gain:**  
This function provides for interfacing between the sensors and the M3

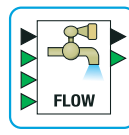

**Flow:**  
This function makes it possible to calculate the flow of a fluid in a conduit using a pressure reducing orifice or for measuring a dynamic pressure

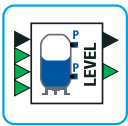

**Level:**  
This function provides for calculating the level of the liquid in a tank, whether open or closed, and whether the liquid's density is constant or not, using pressure sensors.

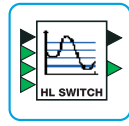

**HL Switch:**  
This function compares the value measured against 5 thresholds

## → Temperature sensors: Pt 100 & Thermocouple

- Thermocouple J:
  - Nickel-plated brass eyelet
  - Stainless steel casing
  - Stainless steel sheath
- Thermocouple K
- Pt 100 Class B:
  - Stainless steel sheath
  - Aluminium vee
- Connection / Sub-base / Flange
- Pt100 for use with XA04 extension (See pages 40-41)
- Thermocouple for use with temperature converter (see page 51)



Temperature sensors

### Part numbers

Type	Description	Temperature	Characteristics	Code
Thermocouple / Pt100	Thermocouple probe J	max: 400 °C	Thermocouple probe J with nickel-plated brass eyelet - Ø 6.5 mm, connection sleeve - Ø 5 x 30 mm in stainless steel 316 L. - Glass filament cable with stainless steel braid: 2 m long - Hot junction isolated from earth	79696030
	Thermocouple probe J	max: 600 °C	Thermocouple probe J with casing - St. steel 304 L Ø 3 mm: 500 mm long PVC cable: 2 m long - Junction cannot be removed - Junction isolated from earth	79696031
	Thermocouple probe J	max: 400 °C	Thermocouple probe J with sheath - ST steel 316 L Ø 5 mm: 30 mm long Glass filament cable with stainless steel braid: 2 m long - Junction isolated from earth	79696033
	Thermocouple probe J	max: 400 °C	Thermocouple probe J with sheath - St. steel 16 L Ø 6 mm: 200 mm long Glass filament cable with stainless steel braid: 2 m long - Junction isolated from earth	79696032
	Thermocouple probe K	max: 1100 °C	Thermocouple probe K with casing - St. steel 304 L Ø 3 mm: 500 mm long PVC cable: 2 m long - Junction isolated from earth	79696034
	Pt100 probe Class B	max: 200 °C	Pt100 probe Class B with sheath - St. steel 316 L Ø 6 mm: 200 mm long Silicon teflon cable: 2 m long - 3-wire assembly	79696035
	Pt100 probe Class B	max: 200 °C	Pt100 probe Class B - Aluminium vee: 50 mm long - Silicon teflon cable: 2 m long - 3-wire assembly - Supplied with fixing clamp	79696037
	Pt100 probe Class B	max: 400 °C	Pt100 probe Class B with sheath - St. steel 316 L Ø 6 mm: 30 mm long Glass filament cable with stainless steel braid: 2 m long - 2-wire assembly	79696036

### Accessories

Accessories	Characteristics	Code
Connection	Sliding connection 1/4 " BSP CYL. St. steel 316 L Ø 3 mm	79696038
	Sliding connection 1/4 " BSP CYL. St. steel 316 L Ø 6 mm	79696039
	Sliding connection 1/2 " BSP CYL. St. steel 316 L Ø 6 mm	79696040
Sub-base	Sliding connection 1/4 " BSP CYL Ø 12 mm Nickel-plated steel	79696041
Flange	Inox flange Ø 6 mm	79696042

### Dimensions (mm)

Connection: 79696038

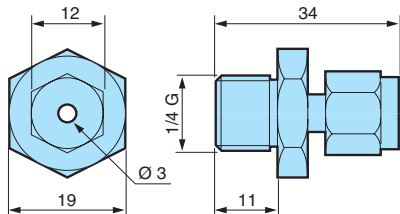

Connection: 79696039

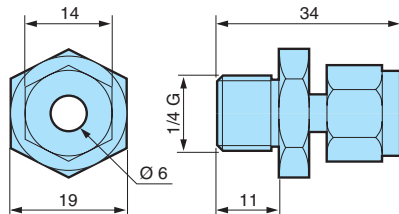

Connection: 79696040

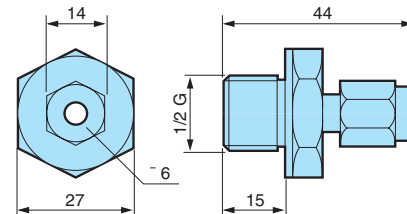

## Dimensions (mm)

Sub-base: 79696041

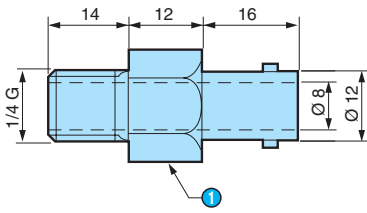

1 17 across flat

Flange: 79696042

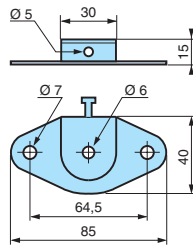

Thermocouple probe J : 79696030

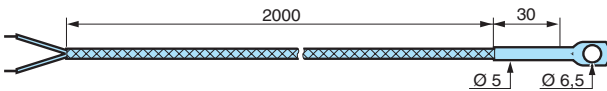

Thermocouple probe J : 79696032

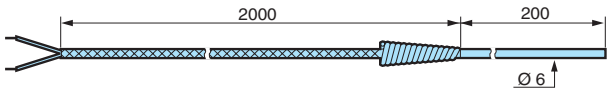

Thermocouple probe K : 79696034

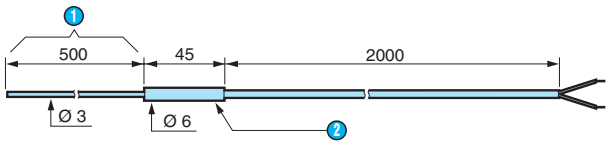

1 Flexible  
2 Stainless steel sleeve

Pt100 probe Classe B : 79696036

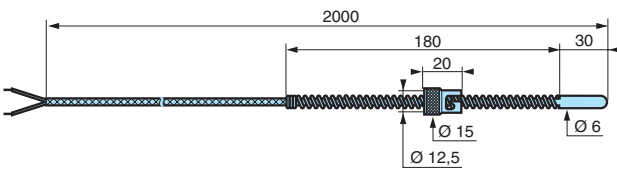

Thermocouple probe J : 79696031

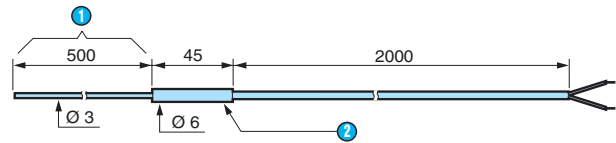

1 Flexible  
2 Stainless steel sleeve

Thermocouple probe J : 79696033

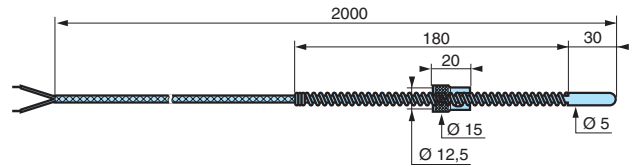

Pt100 probe Classe B : 79696035

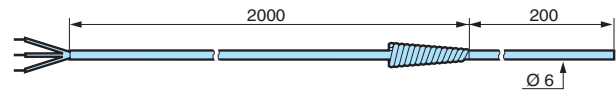

Pt100 probe Classe B : 79696037

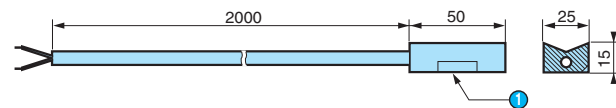

1 Aluminium vee (This part is removable)

# Millenium 3 accessories

## → Temperature sensors

- Integrated converter: 0-10 V  $\overline{\text{---}}$  output for direct connection to the Millenium 3 analogue inputs



Space/Zone Sensor



Ventilation duct



External Sensor

### Part numbers

Type	Description	Range	Accuracy	Supply	Protection casing	Protection probe	Code
AS	Zone/space	-10 → +40°C	-0.2 °C + 1.2°C	24 V $\overline{\text{---}}$	IP30		<b>89750150</b>
	Ventilation duct	-10 → +60°C	-0.2 °C + 1.9°C	24 V $\overline{\text{---}}$	IP65	IP30	<b>89750151</b>
	External	-10 → +40°C	-0.2 °C + 1.2°C	24 V $\overline{\text{---}}$	IP65		<b>89750152</b>
	Remote/submersible probe	-10 → +150°C	-0.2 °C + 1.2°C	24 V $\overline{\text{---}}$	IP65	IP67	<b>89750153</b>
	Remote/submersible probe	-40 → +20°C	-0.2 °C + 1.9°C	24 V $\overline{\text{---}}$	IP65	IP67	<b>89750155</b>

### Accessories

Accessories	Operating temperature	Operating pressure	Code
Copper protective sleeve	-20 → +100°C	10 bar	<b>89750146</b>
316 stainless steel protective sleeve	-20 → +400°C	16 bar	<b>89750147</b>
Heat transfer compound	-	-	<b>18373112</b>

### General characteristics

#### Environmental characteristics

Ambient temperature	-10 → +60°C
Ambient humidity	5 → 95% RH
Housing material	Self-extinguishing

#### Electrical characteristics

Supply voltage	24 V $\overline{\text{---}}$ ( $\pm 10\%$ )
Output	0 → 10 V $\overline{\text{---}}$
Temperature coefficients Derating	0.01%/°C of full scale
Temperature coefficients Offset	1.5 mV / °C

### Dimensions (mm)

#### 89750153 and 89750155

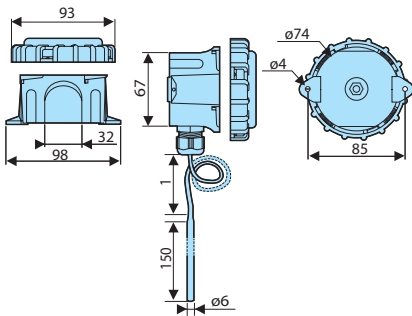

#### Accessory for 89750153 and 89750155

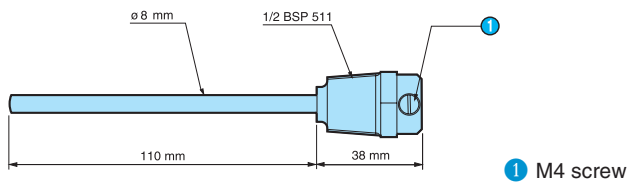

#### 89750151

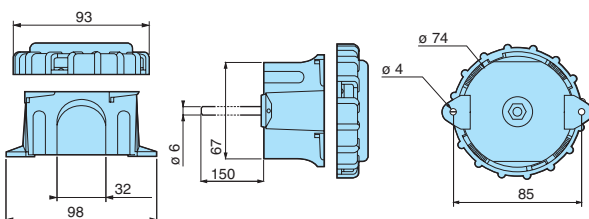

#### 89750150

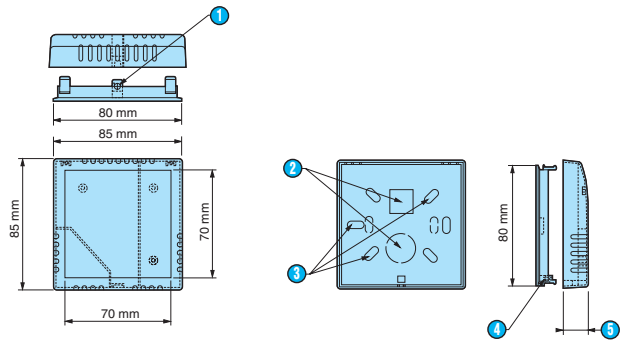

- 1 Ø3 mm for M3 x 8 screw
- 2 Cut-outs made prior to delivery
- 3 Fixing holes
- 4 Indentation for M3 square nut
- 5 Total depth 26 mm

#### 89750152

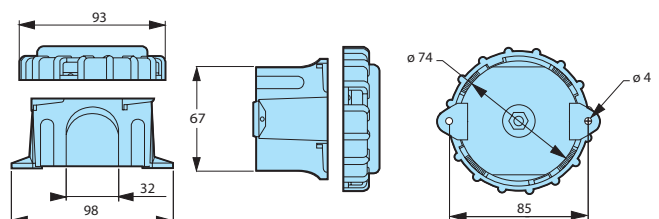



## → DC/DC converters

- Power supplies for extended power ranges
- Provide your devices with a constant supply voltage
- Primary/secondary isolation



Output converter 12 V DC



Output converter 24 V DC

### Part numbers

Type	Input	Output	Nominal power	Code
PS	9-18 V DC	12 V DC	10 W	88950320
	9-36 V DC	24 V DC	6 → 10 W	88950321

### General characteristics

General characteristics	88950320	88950321
<b>See page 20, except:</b>		
Certifications	UL & CSA pending	UL & CSA pending
Output voltage	12 V DC ± 5%	24 V DC ± 5%
Overshoot	20 V DC max.	40 V DC max.
Input limits	9 → 18 V DC (10 W available)	16 → 36 V DC (10 W available) 9 → 16 V DC (see graph)
Immunity from micro power cuts	A 10 W: > 1 ms for 9 V < U < 12V 5 ms for U ≥ 12 V A 6 W: > 5 ms for all voltage range	A 10 W: > 1 ms for 16 V < U < 18 V 5 ms for U ≥ 18 V A 6 W: > 1 ms for U < 12 V > 5 ms for 12 V ≤ U < 18 V > 10 ms for U ≥ 18 V
Isolation primary / secondary	1500 V DC	1500 V DC
Operating temperature	-30 → +70° C	-30 → +70° C
Storage temperature	-40 → +80° C	-40 → +80° C

### Curves

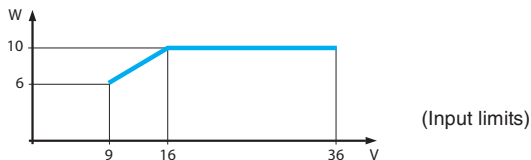

### Dimensions (mm)

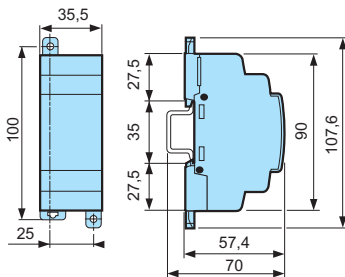

# Millenium 3 accessories

## → Millenium power supply

- With a switch mode power supply, regulated and protected against overloads and short-circuits, these new power supply units are easily integrated in switchboards and enclosures.
- The potentiometer can be used to set the output voltage between 100 and 120% (24 V $\overline{\sim}$  versions) to compensate for any voltage drops on the line.
- The LED continuously signals the presence of voltage at the output and, when flashing, triggering of the self-protection.
- Broad range of supply voltage



PS24 - 7,5 W



PS24 - 20 W



PS24 - 60 W

### Part numbers

Type	Nominal output voltage	Nominal power	Nominal output current	Code
PS	5 V $\overline{\sim}$ (4.75 V $\rightarrow$ 6.25 V)	20 W	4 A	88950305
	12 V $\overline{\sim}$ (11.4 V $\rightarrow$ 15 V)	25 W	2.1 A	88950306
	24 V $\overline{\sim}$ (22.8 V $\rightarrow$ 28.8 V)	7.5 W	0.3 A	88950303
	24 V $\overline{\sim}$ (22.8 V $\rightarrow$ 28.8 V)	15 W	0.6 A	88950304
	24 V $\overline{\sim}$ (22.8 V $\rightarrow$ 28.8 V)	30 W	1.2 A	88950307
	24 V $\overline{\sim}$ (22.8 V $\rightarrow$ 28.8 V)	60 W	2.5 A	88950302

### General characteristics

#### Environmental characteristics

Conformity to standards	IEC/EN 60950-1 IEC/EN 61000-6-2 IEC/EN 61000-6-3 IEC/EN 61204-3 IEC/EN 55022 class B IEC/EN 60364-4-41
Certifications	cULus 508; cCSAus (CSA22.2 n950-1) ; TUV EN 60950-1; CE
Emission	Harmonic: IEC / EN 61000-3-2
Operating temperature	-25 $\rightarrow$ +55°C
Storage temperature	-40 $\rightarrow$ +70°C
Protection class	According to VDE0106 1: Class 2 (Double insulation)

#### Electrical characteristics

Input voltage	100 $\rightarrow$ 240 V $\sim$ single-phase
Supply frequency range	50/60 Hz (+4% / -6%) or 47 $\rightarrow$ 53 Hz/57 $\rightarrow$ 63 Hz
Output voltage	Adjustable from 100 $\rightarrow$ 120%
Peak current on energisation	< 20 A (Except for 88950302: 90A during 1 ms)
Regulation of line and load	$\pm$ 3%
Immunity from micro power cuts	< 10 ms (100 V $\sim$ ) < 150 ms (230 V $\sim$ )
Thermal protection	Yes
Technology	Primary switch mode electronic power supplies
Short-circuit protection	Yes
Overload protection	Yes
Primary protection	Fuse gG 2 A or circuit breaker 2A curve D for 88950303, 88950304, 88950305, 88950306, 88950307 Fuse gG 3 A or circuit breaker 3A curve D for 88950302
Reset after overload	Automatic
Status indication	LED at the output
Dielectric strength	Input / output 3000VAC / 50Hz / 1mm

#### Mechanical characteristics

Mounting	On section, 35 x 7, 5 mm and 35 x 15 mm or on panel (2 x $\varnothing$ 4 mm)
Screw terminals connection capacity	Input connection 2 x 0.14 < 2.5 mm <sup>2</sup> (AWG26...AWG14) Output connection 1 x 0.14 < 2.5 mm <sup>2</sup> (AWG26...AWG14)

## Dimensions (mm)

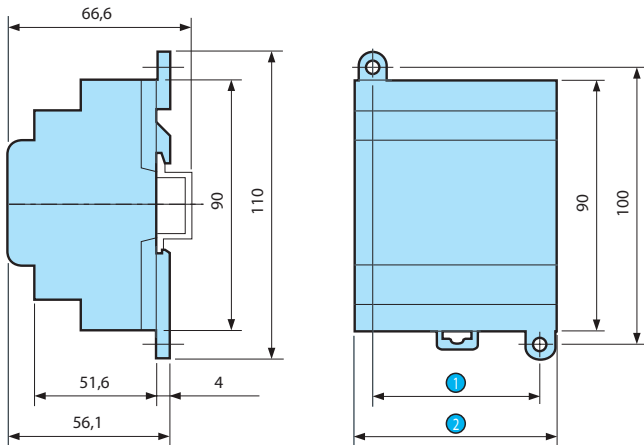

	①	②
88950305	42	54
88950306	42	54
88950303	24	36
88950304	24	36
88950307	42	54
88950302	60	72

## Curves

### Derating

The ambient operating temperature of the Millennium power supplies is 55°C. Above this, a derating is needed up to a maximum operating temperature of 70°C.

The chart below shows the power (compared to the nominal power) that can be permanently supplied by the Millennium power supplies, depending on the operating temperature.

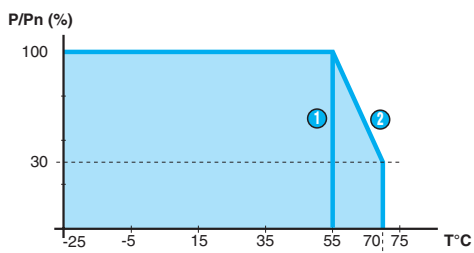

- ① 88950302
- ② 8895030x

# Regulated power supplies

## → "Millenium Supply" switch mode power supply

- Electronic and regulated
- 85 to 264 VAC input
- Conforms to global standards
- Incorporated thermal protection
- PFC filter option



89450

### Part numbers

Type	Input voltage (V)	Output voltage (V)	Nominal power	Nominal current	Reset on protection	Conforms to EN 61000-3-2	Weight (kg)	Code
89450 without PFC	100 → 240 V ~	12 V ---	60 W	5 A	Automatic	No	0.44	89450110
	100 → 240 V ~	24 V ---	60 W	2.5 A	Automatic	No	0.44	89450210
	100 → 240 V ~	24 V ---	100 W	4.2 A	Automatic	No	0.64	89450221
	115 / 230 V ~	24 V ---	150 W	6.2 A	Automatic	No	0.73	89450231
	115 / 230 V ~	24 V ---	240 W	10 A	Automatic	No	1.23	89450241
89450 with PFC	100 → 240 V ~	12 V ---	100 W	8.3 A	Automatic	Yes	0.64	89450122
	100 → 240 V ~	24 V ---	100 W	4.2 A	Automatic	Yes	0.64	89450222
	115 / 230 V ~	24 V ---	150 W	6.2 A	Automatic	Yes	0.97	89450232
	115 / 230 V ~	24 V ---	240 W	10 A	Automatic	Yes	1.23	89450242

### Accessories

Description	Weight (kg)	Code
Mounting bracket	0.085	26450100
Snap-on plate for 35 mm DIN rail	0.035	26450101

### General characteristics

Certifications	UL, cCSAus
Conformity to standards	Generic: UL 508, CSA 22.2 no. 60950 Safety: IEC/EN 60950-1 EMC: EN 61000-6-3, EN 61000-6-2 LF harmonic currents: EN 61000-3-2
<b>Output circuit</b>	
Status indication	Green LED
Operating voltage	12 V --- - 24 V ---
Nominal output current	5 - 8.3 A at 12 V and 2.5 - 4.2 - 6.2 - 10 A at 24 V
Output voltage accuracy	± 10%
Line and load regulation	± 3%
Residual ripple	< 200 mV
Protection against short circuits	Continuous, automatic restart
Protection against voltage surges	U > 1, 2U out
Thermal protection	Yes
<b>Input circuit</b>	
Nominal voltage	100 → 240 V ~ (60 and 100W), 115/230 V ~ (150 and 240W)
Current consumption	U <sub>e</sub> = 240 2 A (60W) - 0.7 A (100W) - 2.5 A (150W) - 3 A (240W) U <sub>e</sub> = 100 2 A (60W) - 1.4 A (100W) - 5 A (150W) - 6 A (240W)
<b>Operating characteristics</b>	
Connection capacity	Input: 2 x 4 mm <sup>2</sup> + earth Output: 2 x 4 mm <sup>2</sup> (60W) ; doubled for 100, 150 and 240W
Ambient storage temperature	-25 → +85
Relative humidity	20 → 90% RH
Vibrations	Conforming to EN 61131-2
Temperature Use	See graph
MTBF	>100.000 hr at 100% load (at 40°)
Generic immunities	Conforming to IEC 61000-6-2
Immunity to electrostatic discharges	Conforming to IEC 61000-4-2 level 3 (4 kV contact/8 kV air)
Immunity to electromagnetic discharges	Conforming to IEC 61000-4-3 level 3 (10V/m)
Immunity to conducted disturbances	Conforming to IEC 61000-4-4 level 3 (2 kV), EN 61000-4-5, EN 61000-4-6 level 3, EN 61000-4-8 level 4, IEC/EN 61000-4-12 level 3
Immunity to mains supply disturbances	Conforming to IEC/EN 61000-4-11 (voltage dips and interruptions)
Incorporated input fuse	Yes
Emission	Generic: conforming to EN 61000-6-3
Connections	Conducted/radiated: conforming to EN 55011, EN 55022 c1B
Dielectric strength	Input/output: 3000 ~ 50/60 Hz 1 min Input/earth: 1500 ~ 50/60 Hz 1 min Output/earth: 500 ~ 50/60 Hz 1 min

## Dimensions (mm)

### 89450 power supplies

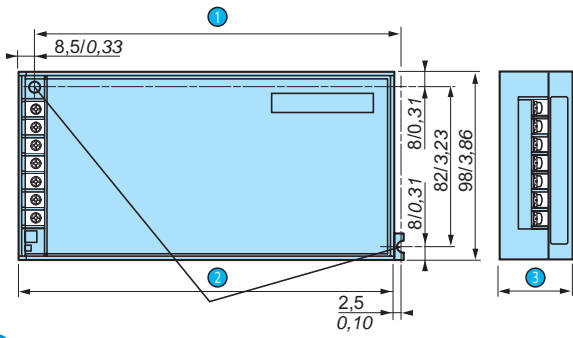

- ① 89450110-210 : 144 mm  
89450221-231-241 : 194 mm  
89450122-222-232-242 : 194 mm
- ② 89450110-210 : 150 mm  
89450221-231-241 : 200 mm  
89450122-222-232-242 : 200 mm
- ③ 89450110-122-210-221 : 38 mm  
89450231-232 : 50 mm  
89450241-242 : 65 mm

### Snap-on plate

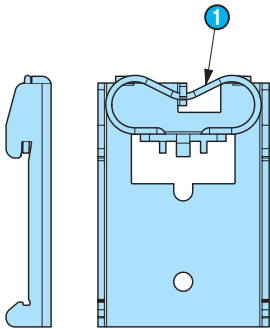

- ① Din Rail mounting bracket

### Mounting bracket

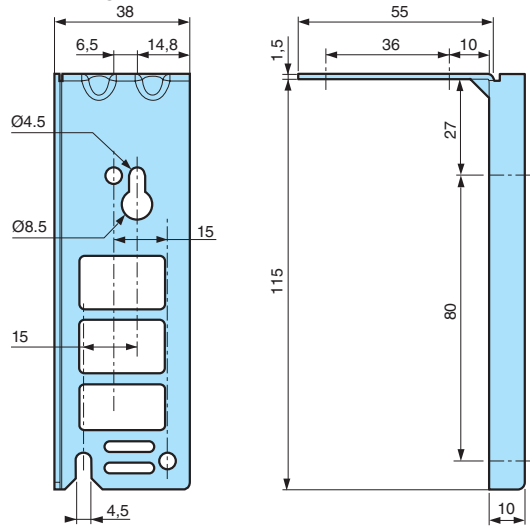

## Curves

### Derating Vertical mounting

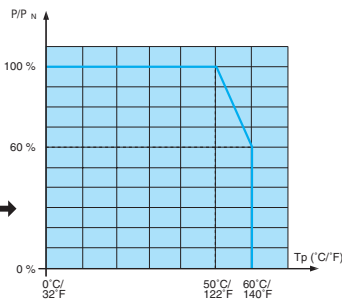
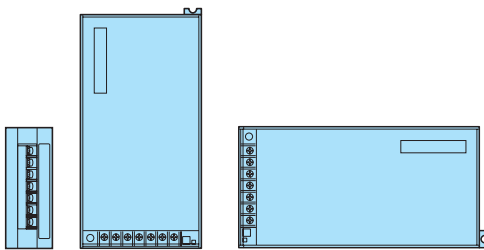

- ① Rated Power
- ② Temperature

### Derating

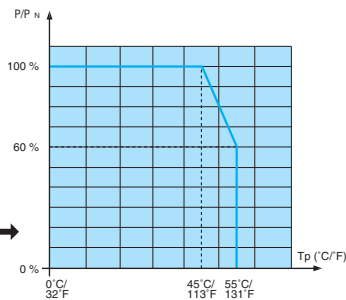
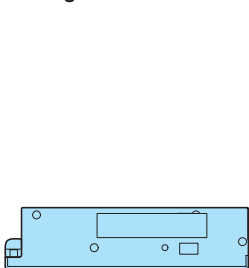

- ① Rated Power
- ② Temperature



## For even greater customisation



■ Application-based marketing



■ Software adaptations



■ Hardware adaptations



■ Enhanced EMC tests



■ Optimised prototype tests

## ▶ A catalogue offer: **adapted products**

In addition to its **Millenium 3 Standard** logic controllers for today's automation needs, Crouzet can also offer **Millenium 3 Custom** logic controllers for specific applications such as renewable energies, water treatment, on-board products and severe environments.

This means that Crouzet can offer a **Millenium 3 Custom** "Catalogue" range of "hardened or specific" products: "**Modular**" versions designed for Custom application-specific functions, "**Bare boards**", "**Resin boards**" and "**application-specific**" extensions.

This expandable offer is subject to ongoing research in order to keep pace with the demands associated with new applications (renewable energies, networked products, etc.).

## ▶ A customisation policy: **specific products**

Crouzet can also provide **Millenium 3 Custom** solutions adapted as required to meet any specification, offering, for example, a greater number of I/O, specific extensions, dedicated connections, product groups (e.g. Millenium 3 + temperature probes), customised laser marking and "Customer" software functions.

To this end, Crouzet has set up a **Customer Adaptation Technical Service (STAC)** with expertise in the various skills required to respond to all your equipment's automation needs:

- Application-based marketing
- Electronics and software design
- Manufacture of customised products
- Prototyping
- Mechanics & connections
- EMC tests & approvals
- Sales & logistics follow-up

Whether for software adaptations, custom functions, adaptations of Millenium 3's operating or physical characteristics, Crouzet has developed extensive expertise in making specific adaptations for each project. Just take a look at the **adaptation wheel** to discover the different levels of customisation offered by Crouzet's Customer Adaptation Technical Service.

# Adaptation, the practical solution!

## Specific products

All our design and industrialisation expertise in control and automation systems at your service, to **design and create specific products** dedicated to your application.

Millenium 3 expanded bare board with 16 relay outputs



## Standard components

A complete range of **logic controllers** available immediately to create your automation application.

Millenium 3 XD10



Millenium 3 Resin board



Millenium 3 adapted application-specific kit



## Adapted products

Defined jointly with our technical sales teams, these **adapted products** offer the exact performance and functions you need for your application.

## Components with added value

Standard products complemented by **factory-mounted auxiliaries or accessories** (connectors, wire outputs, cables, etc.) in order to assist integration into your equipment, simplify your logistics and maximise the reliability of your installation.

Millenium 3 Custom



## For more adaptations



■ “Modular” versions



■ “Bare board” versions



■ “Resin board” versions



■ Application-specific extensions

## Adapted products

Crouzet offers a **Millenium 3 Custom “Catalogue” range based on the Millenium 3 Standard range** whereby characteristics have been expanded or reinforced for use with “specific” applications:

■ **NEW “Modular” versions** designed for Custom application-specific functions and “application-specific” extensions.  
(Part no.: 88974xxx)

- Possible to use dedicated software functions in an industrial environment.

■ **“Bare board” versions** with 12 or 20 I/O on pedestals  
(Part no.: 8897000x & 8897001x)

- Ease of integration into an existing casing or system (mother/daughter boards).
- Optimised cost for integration by OEMs.

■ **“Resin board” versions** for severe environments (vibration/shock/bump resistance and extended temperature range) with an optional removable connectors kit including a foolproofing system.  
(Part no.: 88973xxx)

- Resistance to damp or confined conditions (non-ventilated equipment).
- Vibration/shock/bump resistance.

■ **NEW “Application-specific” analogue extensions** (XA03 & XA04W).  
(Part no.: 889728xx)

- **XA03**: direct control of 3 Pt 100 probes without the need for an external converter.
- **XA04W**: builds on the core expertise of the Millenium 3 (physical control of pumps and filtration) by using an extension which measures the parameters required for good water quality: pH, ORP, conductivity.

### ■ Applications

- **XA03**: temperature regulation (3 Pt100)
- **XA04W**: water quality control for swimming pools, ponds and fountains.

**For details of the characteristics and part numbers of the Millenium 3 Custom range, see pages 70-81.**



# Hardware adaptation capability

## Specific products

Crouzet can also provide **Millenium 3 Custom solutions adapted as required** to meet any specification:

### Toughening

- Resistance to mechanical stresses: making the Millenium impervious to mechanical demands (shocks/vibrations/bumps and falls).  
*For example: other military standards.*
- Resistance to climatic conditions and severe environments: making the Millenium impervious to damp and dripping water, climatic conditions and severe environments (liquids and gases).  
*For example: adapting resin type to make it resistant to acidic atmospheres (HCl, H<sub>2</sub>SO<sub>4</sub>).*
- Compliance with electrical and standard-related constraints: voltage, EMC, etc.  
*For example: increasing radiated electromagnetic immunity (conducted) in the onboard equipment (standard = 10 V/m, adaptation = 20 V/m).*

### Customisation

- Dedicated connections and fixings to provide you with a complete electrical function that can easily be installed in your environment.  
*For example: connecting inputs and outputs on the same terminal block (industrial and agricultural vehicles, professional grass-cutting equipment).*
- Direct lead outputs on resin versions by terminal.
- Combine dedicated sensors with the configured extension.  
*For example: pH/ORP probes.*
- Customised laser marking.  
*For example: integration of customer logo and name on the product.*

### Specific configuration

- Changing the number of I/O.
- Updating the I/O characteristics (input voltage, PNP/NPN polarity type).
- Updating power supply.
- Developing specific extensions.
- Ability to measure and control other physical values.
- Fixed parameters.
- “Modular” versions (88974xx) with removable integrated connectors enabling prewiring work to be performed and improved parts replacement for maintenance purposes.

**For any special applications, please contact our Micro-control sales and technical experts.**

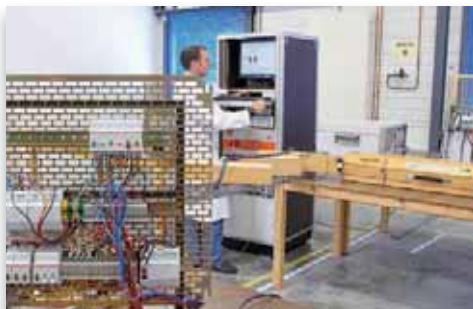

■ Specific EMC tests



■ Electronics adaptation



■ Changing the number of I/O



## For more adaptations

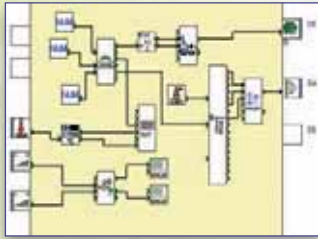

■ Example of program using Custom functions

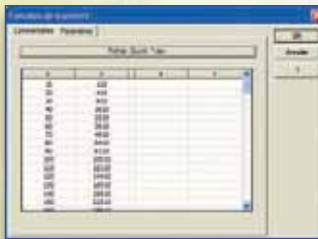

■ Example of a  $y=f(x)$  transfer function from a spreadsheet



- **Morning Pulse:**  
Start: 1 h 10 m before sunrise  
End: 09.00
- **Evening Pulse:**  
Start: 16:00  
End: 2 h 30 m after sunset

## Custom functions

Crouzet has developed a number of application-specific functions to supplement the the library of specific functions:

### Custom functions.

These functions can only be used with products from the Millenium 3 Custom range (Resin, Bare board versions and application specific analogue extensions ).

### Enhancement of standard automation functions



■ **ALARM** (coded alarm for modem):

- Controls 10 alarm levels on one modem digital input.



■ **SHIFT REGISTER:**

- Shifts information by saving it to the memory (shifting of bits in a 16-bit word on each rising edge of the clock).



■ **SPLIT BY 4** (input 1 x 16-bit word, output 4 x 4-bit words):

- Splits a 16-bit word into 4 x 4-bit words (in groups of 4 bits).



■ **SPLIT BY 2** (input 1 x 16 bit word, output 2 x 8 bit words):

- Splits a 16-bit word into 2 x 8-bit words (in groups of 8 bits).



■ **SLIN S** (serial link protected input):

- Transmits data via a programming port to memory space in the controller's fixed addresses.  
Data is protected in the event of disconnection of the controller power supply.

### Function for a specific temperature control application in HVAC



■ **NTC1** - Function for use in conjunction with the **NTC probe** accessory (see page 79):

- The application-specific function converts the resistive values measured by the probe into temperature values in degrees Celsius (preliminary entry as part of the application-specific function of all measurements taken by a given NTC probe).

# Software adaptation capability

## Functions on request



■ Developing dedicated functions



■ Function for compressor



■ Function for solar panels

**Crouzet is also able to adapt existing functions in both Standard and Custom ranges.**

- Adaptation of high-speed counting function.
- Adaptation of the NTC1 function on other types of NTC probe.

**On request, Crouzet can also develop advanced application-specific functions, dedicated to your process.**

- **Motor wear calculation:** controls the service life of pumps for more effective pump equipment maintenance.
- **Special functions for compressor/booster compressor:** Anti-short cycle (reduces pump wear during start-up and switches pump starting sequences for greater efficiency): function controlling compressor switching in accordance with changes at the analogue input for pressure, expressed in bars.
- **Zero speed:** system which makes it possible to detect conveyor belt interruptions on packaging machines.
- **Special software protection functions.**

These custom functions simplify your application, protect your expertise and therefore guarantee you total protection.

- **Mathematical function for mobile solar panels:** Crouzet has developed a program which **determines the exact position of the sun, 365 days a year, 24 hours a day.** Having first recorded the latitude and longitude of the installation, Millenium 3 analyses and returns information for the exact **position of the panels** in relation to the sun.

## “ To help me design my solar panels,

Crouzet were able to offer me an application-specific function. Millenium 3 turns the panels towards the sun and checks its actual position by means of encoders. If the difference is more than a few degrees, motors move them horizontally and vertically.

In addition, a wind sensor measures its speed and the panel adopts a “park” position in the event of a storm.

Juan Alberto, Solar Panel Manufacturer ”





## For more adaptations

### Application: Controlling water quality in a swimming pool.

- Control systems located in machine rooms.
- Manufacturers of swimming pools, OEM wholesalers of swimming pools.

### Description of customer needs:

- Control physical filtration of water (using a filter).
- Set filtering time in relation to the temperature of the bathing water.
- Control the neutrality of the water (pH).
- Control the level of water disinfection (Redox: chlorine-based disinfectant).



■ Private swimming pool

## Application **Water treatment**

### How the application works:

Water needs to be filtered regularly to remove solid particles (sand, plant matter, insects, suntan oil, hair, etc.) and keep it clear. The higher the temperature, the longer it takes to filter.

**Water quality** is essential for swimming pool applications. Regular checks should be carried out in respect of:

- Neutrality of the water (should be  $7.2 < \text{pH} < 7.5$ )
- Level of water disinfection (optimum level of chlorine in water for destroying bacteria)

Both **pH** and **Redox** are measured using probes submerged in pipes, a buffer container, or an analysis chamber. These probes analyse the presence of hydrogen (H+) and chlorine (Cl) ions capable of oxidising an electrochemical couple within the probe. This oxidation generates an electrical voltage, expressed in mV, which is forwarded to the PLC. After a calibration process, the PLC converts this into values for the pH and Redox.

### Crouzet solution:

- Millenium 3 XD10 24 V DC logic controller.
- 100 - 240 V AC/24 V DC power supply.
- XA04W "application-specific" analogue extension: Measuring extension card in modular casing.
- pH probe, ORP (Redox) probe and Pt100 probe.
- As an option: Modem communication solution with GSM for sending alarms.

### The benefits of the Crouzet solution:

- **"All-in-one"**: the same PLC controls the physical filtration and chemical treatment functions.
- Simple, straight-forward programming.
- Additional Millenium 3 functions available to control other application requirements (lighting control, vacuum pumps for pool cleaning brushes).
- The most compact extension on the market (72 mm).
- Optional SMS alerts via integrated Millenium 3 modem solution.
- Crouzet also has expertise in the **area of position sensors and micromotors**, and is able to offer motorisation solutions (swimming-pool covers using winders or curtains).

# Dedicated product application

## Application Heat pumps

### Application: Heat pump control.

#### Description of customer needs:

- Make the best use of nature's energy (air, water, earth) to heat or cool (reversible system) a heating circuit or a hot water system in either an industrial, domestic or commercial setting.
- The choice of solution may be determined by financial considerations (energy costs).



■ Control of heating and hot water system: Heat pump

#### How the application works:

The heat from the warm fluid (air blown by a fan, or water provided by a heat-exchanging source or coolant) is captured by a refrigerating liquid which is compressed to give it a pressure of 40 bar and a temperature 140°C. In a heat exchanger, this refrigerating liquid then transfers its heat to water (cold source) for a hot water system (underfloor heating) or a hot water tank (water for a hot water system or swimming pool).

Once this thermal exchange has taken place, the fluid which has lost both temperature and pressure has its pressure further reduced by a solenoid valve which drastically reduces its temperature even more.

This fluid is then able to receive the heat from the hot source, and the cycle is ready to begin again.

#### Crouzet solution:

- Millenium 3 logic controller.
- Millenium 3 accessories:
  - **NTC**: temperature (°C) probe – probe providing resistance as a function of the temperature. Connects directly to the analogue inputs (0-10 V). A dedicated function block enables resistance to be converted into temperature.
  - **Pt100**: temperature probe with a converter on the analogue inputs or directly linked to extensions XA03, XA04W.
- Compressor start-up control/anti-short cycle.

#### The benefits of the Crouzet solution:

- User-friendly software and ease of programming.
- Front-panel parameter setting for temperature instructions.
- Functions include clock, vacations, frost protection.
- Full/half-load function.
- Analogue inputs: NTC probes.
- Adaptations possible (development of “water law” or “heating curve” functions).



## → "Application-specific" and grouping adapted kits

- Discover just what Millenium 3 can do for you - its complete kits provide everything you need for your application
- Product groups: in order to facilitate logistics, we can supply groups of products



### Part numbers

Type	Description	Code
Kit 16	XD10 - 24 V $\overline{\text{---}}$ (Ref. 88970141) + XN05 (Ref. 88970270) + 1 Power supply PS24-30 W (Ref. 88950307)	<b>88970825</b>
Kit 20	CD20 - 24 V $\overline{\text{---}}$ (Ref. 88970051) + 1 Power supply PS24-60 W (Ref. 88950302)	<b>88970808</b>
Kit 26	XD26 Custom - 24 V $\overline{\text{---}}$ (Ref. 88974161) + M3 SOFT (Ref. 88970111) + Power supply PS24-30W (Ref. 88950307) + USB link cable (Ref. 88970109)	<b>88970094</b>
Kit 32	XD26 - 24 V $\overline{\text{---}}$ (Ref. 88970161) + XR06 (Ref. 88970211) + 1 Power supply PS24-60 W (Ref. 88950302)	<b>88970813</b>

## → Bare board version

- For easy and discreet integration into your applications
- For mass-production applications
- Memory: 120 lines in LADDER language and up to 350 "typical" blocks in FBD language
- Compact Dimensions
- Range of controllers for use with application specific functions



NB 12



NB 20

### Part numbers

Type	Input	Output	Supply	Code
NB12	8 digital (of which 4 are analogue)	4 relays	24 V $\overline{\text{---}}$	88970001
	8 digital	4 relays	100 → 240 V $\sim$	88970003
	8 digital (of which 4 are analogue)	4 relays	12 V $\overline{\text{---}}$	88970005
NB20	12 digital (of which 6 are analogue)	8 relays	24 V $\overline{\text{---}}$	88970011
	12 digital	8 relays	100 → 240 V $\sim$	88970013
NBxx	In accordance with your requirements	In accordance with your requirements	In accordance with your requirements	●

### Accessories

Type	Description	Code
M3 SOFT	Multilingual programming software containing specific library functions (CD-ROM)	88970111
PA	EEPROM memory cartridge	88970108
	3 m serial link cable: PC → Millenium 3	88970102
	3 m USB link cable: PC → Millenium 3	88970109
	Millenium 3 → Bluetooth interface (class A 10 m)	88970104

### General characteristics

#### See page 22, except:

Protection rating	IP00
Certifications	UL, CSA

### Dimensions (mm)

NB12

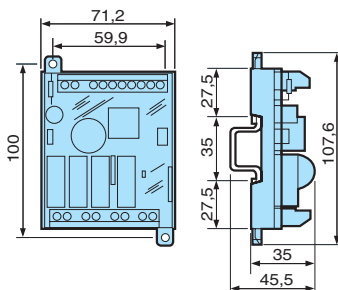

NB20

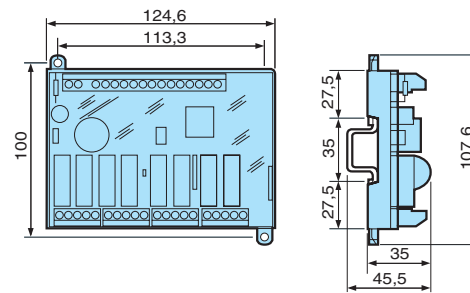

### Input / Output Connections

See Page 80-81 for details or to find instruction sheets visit: [www.millenium3.crouzet.com](http://www.millenium3.crouzet.com) in "Download"

### Product adaptations

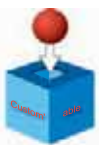

- Tropicalisation
- Spring connectors or removable connectors
- Changing the number of I/O
- Updating power supply



## → Modular version

- "Modular" versions designed for Custom application specific functions and "application-specific" extensions (XA03, XA04W) for expandable range.
- Open to "standard" extensions (XN, XR, XE, XA)
- LCD with 4 lines of 18 characters and configurable backlighting or no display or parameter-setting buttons to avoid tampering by unauthorised users



CB12 Custom



XD10 Custom

### Part numbers

#### Custom Compact Range

Type	Input	Output	Supply	Code
CD12	8 digital (including 4 analogue)	4 relays 8 A	24 V $\overline{\text{---}}$	88974041
	8 digital (including 4 analogue)	4 solid state 0.5 A (including 1 PWM)	24 V $\overline{\text{---}}$	88974042
	8 digital	4 relays 8 A	100 $\rightarrow$ 240 V $\sim$	88974043
	8 digital	4 relays 8 A	24 V $\sim$	88974044
	8 digital (including 4 analogue)	4 relays 8 A	12 V $\overline{\text{---}}$	88974045
CD20	12 digital (including 6 analogue)	8 relays 8 A	24 V $\overline{\text{---}}$	88974051
	12 digital (including 6 analogue)	8 solid state 0.5 A (including 4 PWM)	24 V $\overline{\text{---}}$	88974052
	12 digital	8 relays 8 A	100 $\rightarrow$ 240 V $\sim$	88974053
	12 digital	8 relays 8 A	24 V $\sim$	88974054
	12 digital (including 6 analogue)	8 relays 8 A	12 V $\overline{\text{---}}$	88974055
CB12	8 digital (including 4 analogue)	4 relays 8 A	24 V $\overline{\text{---}}$	88974021
	8 digital	4 relays 8 A	100 $\rightarrow$ 240 V $\sim$	88974023
	8 digital	4 relays 8 A	24 V $\sim$	88974024
CB20	12 digital (including 6 analogue)	8 relays 8 A	24 V $\overline{\text{---}}$	88974031
	12 digital	8 relays 8 A	100 $\rightarrow$ 240 V $\sim$	88974033
	12 digital	8 relays 8 A	24 V $\sim$	88974034

### Part numbers

#### Custom Expandable Range

Type	Input	Output	Supply	Code
XD10	6 digital (including 4 analogue)	4 relays 8 A	24 V $\overline{\text{---}}$	88974141
	6 digital (including 4 analogue)	4 solid state 0.5 A (including 1 PWM)	24 V $\overline{\text{---}}$	88974142
	6 digital	4 relays 8 A	100 $\rightarrow$ 240 V $\sim$	88974143
	6 digital	4 relays 8 A	24 V $\sim$	88974144
XD26	16 digital (including 6 analogue)	10 relays (8 x 8 A relay and 2 x 5 A relay)	24 V $\overline{\text{---}}$	88974161
	16 digital (including 6 analogue)	10 solid state 0.5 A (including 4 PWM)	24 V $\overline{\text{---}}$	88974162
	16 digital	10 relays (8 x 8 A relay and 2 x 5 A relay)	100 $\rightarrow$ 240 V $\sim$	88974163
	16 digital	10 relays (8 x 8 A relay and 2 x 5 A relay)	24 V $\sim$	88974164
	16 digital (including 6 analogue)	10 relays (8 x 8 A relay and 2 x 5 A relay)	12 V $\overline{\text{---}}$	88974165
XB10	6 digital (including 4 analogue)	4 relays 8 A	24 V $\overline{\text{---}}$	88974131
	6 digital (including 4 analogue)	4 solid state 0.5 A (including 1 PWM)	24 V $\overline{\text{---}}$	88974132
	6 digital	4 relays 8 A	100 $\rightarrow$ 240 V $\sim$	88974133
	6 digital	4 relays 8 A	24 V $\sim$	88974134
XB26	16 digital (including 6 analogue)	10 relays (8 x 8 A relay and 2 x 5 A relay)	24 V $\overline{\text{---}}$	88974151
	16 digital (including 6 analogue)	10 solid state 0.5 A (including 4 PWM)	24 V $\overline{\text{---}}$	88974152
	16 digital	10 relays (8 x 8 A relay and 2 x 5 A relay)	100 $\rightarrow$ 240 V $\sim$	88974153
	16 digital	10 relays (8 x 8 A relay and 2 x 5 A relay)	24 V $\sim$	88974154
	16 digital (including 6 analogue)	10 relays (8 x 8 A relay and 2 x 5 A relay)	12 V $\overline{\text{---}}$	88974155





## General characteristics

<b>See page 22, except:</b>	
Certifications	UL, CSA
Operating temperature*	-30 → +70°C (—); -20 → +70° C (～); Operating temperature @ 100% (Relays 6A) Operating temperature @ 66% (Relays 8A)
Storage temperature*	-30 → +80°C
LCD display	Display with 4 lines of 18 characters, white characters on a blue background

\* : Available last quarter of 2008

## Accessories

Type	Designation	Code
M3 SOFT	Multilingual programming software containing specific library functions (CD-ROM)	88970111
PA	EEPROM memory cartridge	88970108
	3 m serial link cable: PC → Millenium 3	88970102
	3 m USB link cable: PC → Millenium 3	88970109
	Millenium 3 → Bluetooth interface (class A 10 m)	88970104

## Dimensions (mm)

CB12/XB10 Custom

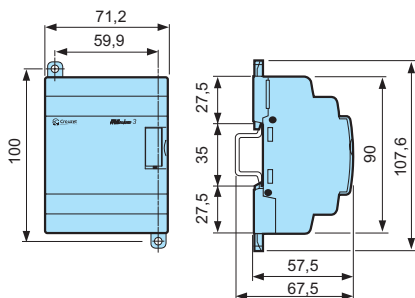

CD12/XD10 Custom

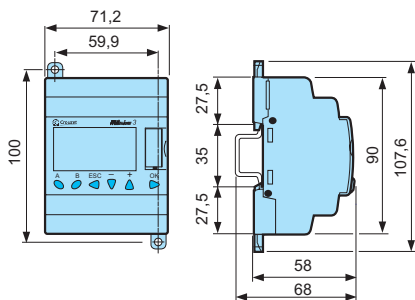

CB20/XB26 Custom

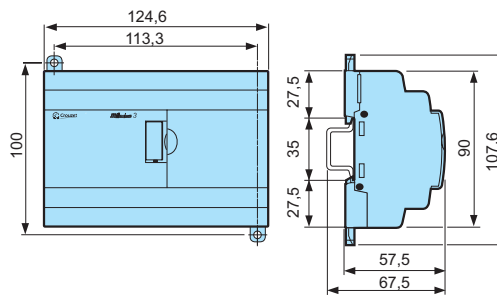

CD20/XD26 Custom

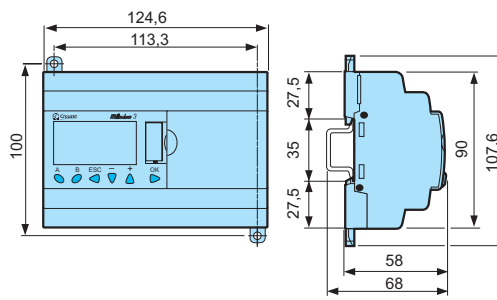

## Input / Output Connections

See Page 40-43 for details or to find instruction sheets visit: [www.millenium3.crouzet.com](http://www.millenium3.crouzet.com) in "Download"



## → Resin board version

- Vibration resistance
- Extended temperature range
- Outputs via removable connectors
- IP50 seal (connectors)
- DB 9-pin programming port via standard RS 232 cable
- Designed for Custom application-specific functions
- Supplied without connectors. Connectors available (Ref. 88970313, 88970314, 88970315, 88970316)



NBR12



NBR26



NBR32

### Part numbers

Type	Designation	Input	Output	Supply	Code
NBR12	Relay outputs with connectors	8 digital (including 4 analogue)	4 relays	24 V $\text{---}$	88973001
	Relay outputs with connectors	8 digital (including 4 analogue)	4 solid state (including 1 PWM)	24 V $\text{---}$	88973002
NBR26	Relay outputs with connectors	16 digital (including 6 analogue)	10 relays	24 V $\text{---}$	88973061
	Relay outputs with connectors	16 digital (including 6 analogue)	10 solid state 0.5 A (including 4 PWM)	24 V $\text{---}$	88973062
	Relay outputs with connectors	16 digital	10 relays	100 $\rightarrow$ 240 V $\sim$	88973063
NBR32	Relay outputs with connectors	20 digital (including 6 analogue)	12 relays	24 V $\text{---}$	88973211
NBR40	Relay outputs with connectors	24 digital (including 6 analogue)	16 relays	24 V $\text{---}$	88973231
NBRxx	Relay or solid state outputs, connectors or wires	In accordance with your requirements	In accordance with your requirements	In accordance with your requirements	•

### Accessories

Type	Description	Code
M3 SOFT	Multilingual programming software containing specific library functions (CD-ROM)	88970111
PA	1.80 m serial link cable: DB9/DB9	88970123
	Programming cable USB	88950105
MA	Removable connector kit for NBR12	88970313
	Removable connector kit for NBR26	88970314
	Removable connector kit for NBR32	88970315
	Removable connector kit for NBR40	88970316

### General characteristics

See page 22, except:

Certifications	CE
Protection index	IP50 connectors
Mechanical resistance IEC 61373	Railway applications - Rolling stock Category 1 class B stock mounted on car Vibration resistance: 5-150 Hz Random sampling: 10 minutes in each direction (X, Y, Z) Sinusoidal sampling: 5 hours in each direction (X, Y, Z) Shock resistance: 3 shocks 3 g/30 ms per direction Dropping: Total of 26 drops on all sides from a height of 1 metre
Mechanical resistance GAM EG 13	Terrestrial military vehicles Vibration resistance 5-500 Hz 50 m/s <sup>2</sup> Sinusoidal sampling 5 hours in each direction (X, Y, Z) Shock resistance: Acceleration: 150 m/s <sup>2</sup> , duration: 11 ms, 3 shocks per shaft Acceleration: 300 m/s <sup>2</sup> , duration: 11 ms, 3 shocks per shaft Bumps: 1000 half wave sine mechanical bumps 25 g/6 ms per shaft
Operating temperature	-30 $\rightarrow$ +70°C ( $\text{---}$ ), -20 $\rightarrow$ +70°C ( $\sim$ )
Storage temperature	-40 $\rightarrow$ +80°C
Housing	Self-extinguishing UL94V2
Resin	UL approved Self-extinguishing UL94V0 Semi-rigid polyurethane resin Solid black appearance Breakdown voltage: 25 kV/mm Water absorption: 0.2% (24 hours at 23°C) Shore D hardness: 50 $\pm$ 5 Smoke category: F0
Outputs	Removable connectors
Breaking current	6 A relay output



## Dimensions (mm)

**NBR12**

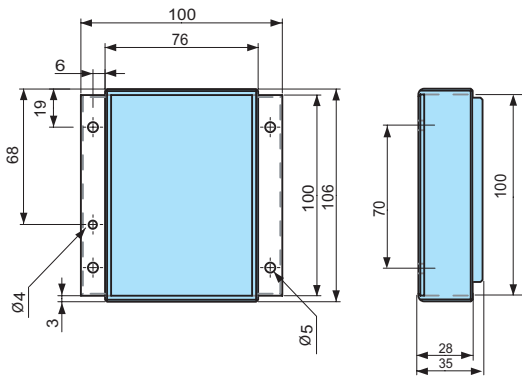

**NBR26**

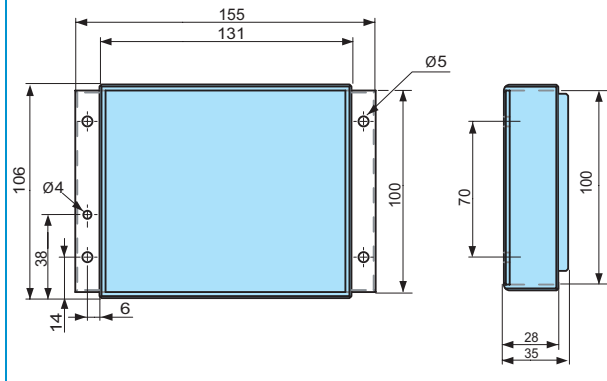

**NBR32**

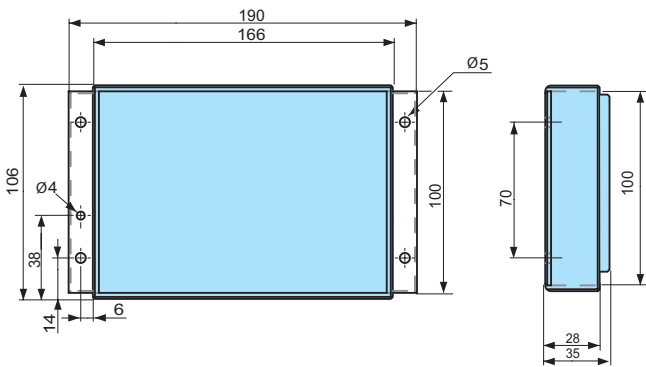

**NBR40**

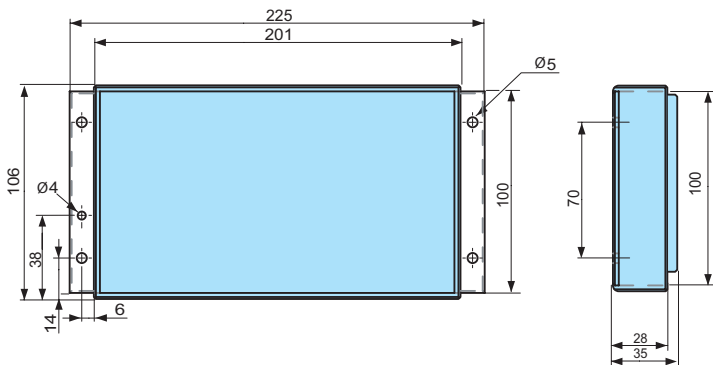

## Input / Output Connections

See Page 80-81 for details or to find instruction sheets visit: [www.millennium3.crouzet.com](http://www.millennium3.crouzet.com) in "Download"

## Product adaptations



- 40 cm wire
- Extended power supply range (9 → 18 V $\overline{\text{=}}$ ), (16 → 36 V $\overline{\text{=}}$ ), (85 → 264 V $\sim$ )
- Remote polyester keyboard
- UL, CSA, GL certification
- Integration of all available electrical functions in the catalogue (e.g.: Bluetooth module, Pt 100 input, 0-20 mA input, 0-10 V power output, etc.)
- Changing the number of I/O.



## → "Application-specific" analogue extensions for XD10/XB10 and XD26/XB26

- **XA04W:** Mix of inputs in the same casing: Pt 100, pH, ORP (Redox), Current (4 - 20 mA)
- **XA03:** 3 Pt 100 temperature inputs in the same casing
- "Application-specific" examples:
  - Regulation and measurement of (XA03)
  - pH and Redox sensors for treating water in swimming pools and fountains (XA04W)
- Extensions compatible with any Millenium 3 Custom expandable logic controller
- For Pt100 probes, see page 54.
- For pH and ORP probes, see page 78. The probes are directly connected to the XA04W extension



XA03



XA04W

### Part numbers

Type	Input	Supply	Code
XA03	3 Pt 100 (-25 → +125°C)	Via the 24 V $\overline{\text{DC}}$ controller	88970800
XA04W	1 Pt 100 (0-50°C), 1 pH (0-14), 1 ORP (0-1000mV), 1 current (4-20 mA)	Via the 24 V $\overline{\text{DC}}$ controller (1 dedicated output 24 V $\overline{\text{DC}}$ $\pm$ 5% 0.6 W to supply the 4-20 mA sensor)	88972805

### Accessories

Type	Description	Code
M3 SOFT	Multilingual programming software containing specific library functions (CD-ROM)	88970111

### General characteristics

88970800      88972805

See General characteristics for the XA04 analogue extension on page 36, except for the adapted characteristics below:

	88970800	88972805			
Certifications	UL, CSA,	UL & CSA			
Conformity with the EMC directive	In accordance with 89/336/EEC: EN (IEC) 61131-2 (Zone B) EN (IEC) 61000-6-2, EN (IEC) 61000-6-3, EN (IEC) 61000-6-4	In accordance with 89/336/EEC: EN (IEC) 61000-6-1 EN (IEC) 61000-6-3			
Inputs	Pt 100 (IP, IQ, IR)	Pt 100 (IP)	pH (IQ)	ORP (IR)	4-20 mA (IS)
Operating range	-25°C, + 125°C	0-50°C	0 - 14	0 - 1000 mV	0 - 20 mA
Input impedance	-	-	> 10 <sup>12</sup> Ω	> 10 <sup>12</sup> Ω	10 Ω
Maximum non destructive current/voltage	-	-	-	-	30 mA
Resolution	10 bits	12 bits	12 bits	12 bits	12 bits
Value of LSB	0.15°C	0.012°C	0.0034 pH	0.24 mV	4.9 μA
Input type	Pt 100 probe IEC 751 3-wire	Pt 100 probe IEC 751 3-wire	pH probe	ORP probe	Common mode
Conversion time	Module cycle time	Module cycle time	Module cycle time	Module cycle time	Module cycle time
Sampling time	<1s	4s	4s	4s	4s
Accuracy at 25°C ambient temperature	± 1°C	± 0.8°C	± 0.05 pH	± 5 mV	± 0.1 mA
Accuracy at 55°C ambient temperature	± 1°C	± 0.8°C	± 0.05 pH	± 5 mV	± 0.1 mA
Temperature compensation	-	-	No Drift of 0.03 pH from 15 to 25°C Drift of 0.15 pH from 0 to 50°C	-	-
Isolation between analogue channel and power supply	None	None	Isolated	Isolated	Isolated
Dedicated isolated 24 V DC output for 4-20 mA sensor	-	-	-	-	24 V $\overline{\text{DC}}$
Cable length	10 m max. with shielded cable	3 m max. with shielded cable	3 m max. with shielded cable	3 m max. with shielded cable	3 m max. with shielded cable
Protection against polarity inversions	-	-	-	-	Yes



## Dimensions (mm)

XA03

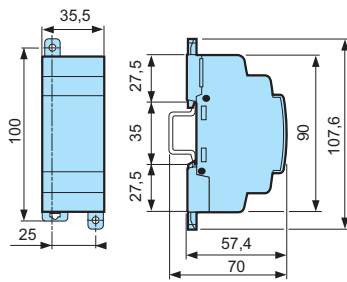

XA04W

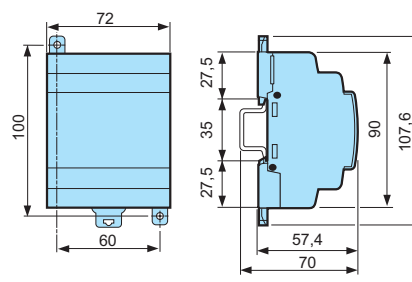

## Input / Output Connections

See Page 80-81 for details or to find instruction sheets visit: [www.millennium3.crouzet.com](http://www.millennium3.crouzet.com) in "Download"

## Product adaptations



- 2 or 3-wire Pt 1000 inputs
- Adjustable temperature range
- Option to select/limit the number of temperature, Pt100 and Pt1000 inputs (up to 3)
- Option to mix and/or choose inputs (Pt100, pH, ORP, 4-20 mA, 0-10 V)
- Modified resolution (10 bits, 12 bits)
- Bare board version
- Resin casing version
- Customer labelling



## → pH & ORP probes for XA04W

- High quality measurement electrode
- 2 types of ferrule
- Fields of application:
  - Swimming pools
  - Monitoring and treatment of drinking water
  - Freshwater or seawater aquariums
  - Waste water, process water and low-pollution domestic water, rainwater, pond water and surface water
  - Greenhouses



Sensor pH



Sensor ORP

### Part numbers

Type	Description	Code
pH	pH probe with BNC connector 3 m	89750170
	pH probe with ferrules 3 m	89750171
ORP	ORP probe with BNC connector 3 m	89750172
	ORP probe with ferrules 3 m	89750173

### General characteristics

Type	pH	ORP (Redox)
Operating range	2 - 12	± 2000 mV
Pressure	0-6 bar	0-6 bar
Electrode	Combination electrode with protected glass bulb	Combination electrode
Length	120 mm	120 mm
Diaphragm	None	None
Operating temperature	0 → +60°C	0 → +60°C
Electrolyte	3.5 mol saturated KCl gel	3.5 mol saturated KCl gel
Concentration	< 50 gr/l	< 50 gr/l
Chlorinated water	< 5 ppm (max. non repetitive 15/20 ppm)	< 5 ppm (max. non repetitive 15/20 ppm)
Installation angle	360°, recommended ± 45° from vertical	360°, recommended ± 45° from vertical
Cable length	Shielded cable, 3 m	Shielded cable, 3 m
Protection against polarity inversions	Incorrect reading	Incorrect reading

### Comments

The probes are delivered with a cap containing a preservative. Ensure this cap is removed just before inserting the probe. Minimise the storage time and always check that this preservative is present (KCl refill). The probe must be stored horizontally.

### Dimensions (mm)

#### pH-ORP probes

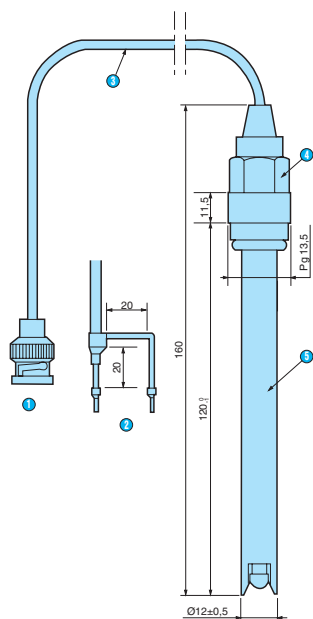

- ① BNC
- ② Ferrule
- ③ Coaxial cable, black, Ø 3 mm
- ④ Connecting head  
Head with Pg 13.5 thread and fixed cable
- ⑤ Plunger made of black PPO



## → NTC probe

- Direct connection with no converter on analogue input
- Low-cost temperature control solution
- Fields of application:
  - HVAC
  - Compressors
  - Geothermal systems



Sensor NTC

### Part numbers

Type	Description	Ohmic value	Measurement range	Code
AS	NTC probe (batch of 10) for Millenium 3 (24 V $\overline{\text{---}}$ , $\pm 10\%$ )	10 k $\Omega$ @ 25°C	-25 $\rightarrow$ +85° C	89750180
	NTC probe (batch of 100) for Millenium 3 (24 V $\overline{\text{---}}$ , $\pm 10\%$ )	10 k $\Omega$ @ 25°C	-25 $\rightarrow$ +85° C	89750181

### Accessories

Accessories	Operating temperature	Operating pressure	Code
Copper protective sleeve	-20 $\rightarrow$ +100°C	10 bar	89750146
316 stainless steel protective sleeve	-20 $\rightarrow$ +400°C	16 bar	89750147

### General characteristics

#### Environmental characteristics

Operating temperature	-25 $\rightarrow$ +85°C
Storage temperature	-30 $\rightarrow$ +100°C
Accuracy	-25 °C $\rightarrow$ +40 °C: = $\pm 0.8$ °C (Repeat accuracy $\leq \pm 0.5$ °C) +40 °C $\rightarrow$ +50 °C: = $\pm 1.2$ °C (Repeat accuracy $\leq \pm 1$ °C) +50 °C $\rightarrow$ +60 °C: = $\pm 1.4$ °C (Repeat accuracy $\leq \pm 1.4$ °C) +60 °C $\rightarrow$ +70 °C: = $\pm 2$ °C (Repeat accuracy $\leq \pm 2$ °C) +70 °C $\rightarrow$ +85 °C: = $\pm 3$ °C (Repeat accuracy $\leq \pm 2$ °C)

#### Mechanical characteristics

Cable	-30 $\rightarrow$ +100°C, 2 identical colour wires
Cable length	60 cm

#### Comments

Analogue input configured as potentiometer via the Custom function (NTC1, in M3 SOFT software part no.: 88970111).  
 Probes only available on the Custom range (88974XXX, NB, NBR)

### Dimensions (mm)

89750180

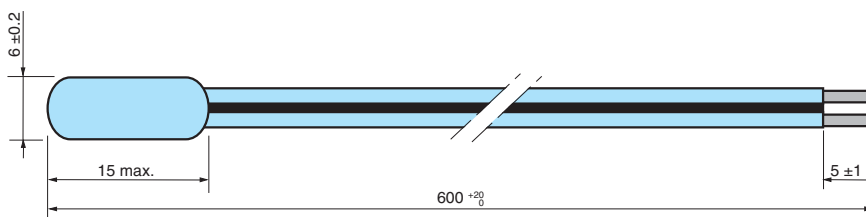
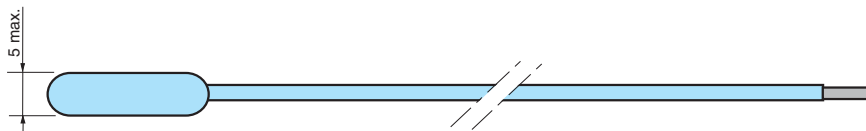



## → I/O wiring

### Inputs/Outputs: NB & NBR

See pages 40 to 41 (same as CD, CB, XD, XB)

### Analogue inputs: XA03 & XA04W

Extension : XA04W

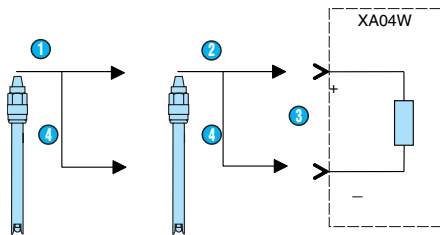

- 1 pH
- 2 ORP/Redox
- 3 Analogue input
- 4 Screening

Extension : XA04W

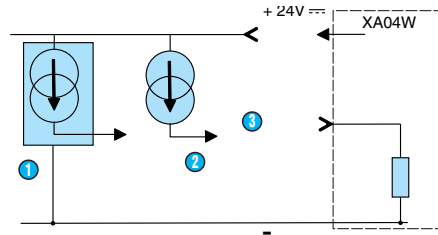

- 1 0-20 mA 3-wire
- 2 0-20 mA 2-wire
- 3 Analogue input

Extensions : XA03, XA04W

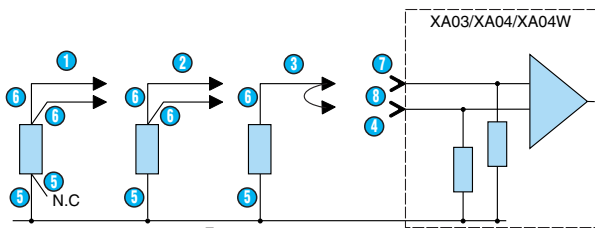

- 1 Pt100 4-wire
- 2 Pt100 3-wire
- 3 Pt100 2-wire
- 4 Analogue inputs (e.g. IP & P)
- 5 White
- 6 Red

## → Input/output installations

### Extensions XA04W & XA03

#### Inputs

XA04W

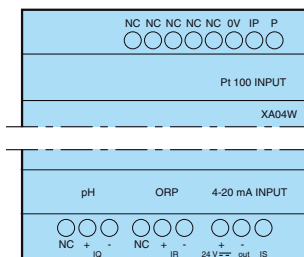

XA03

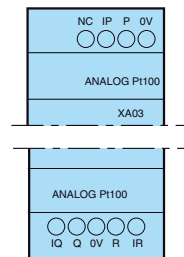





## → Input/output installations

### Bare boards (NB12, NB20) & resin boards (NBR12, NBR26, NBR32, NBR40)

#### Inputs

**NB12, NBR12**

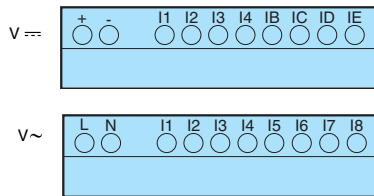

**NB20**

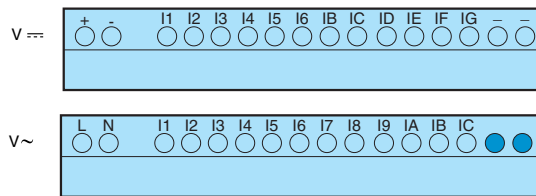

**NBR26**

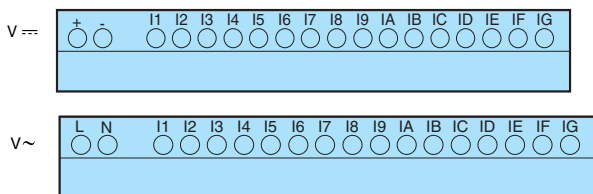

**NBR32**

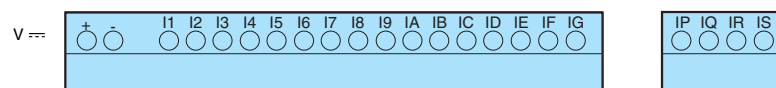

**NBR40**

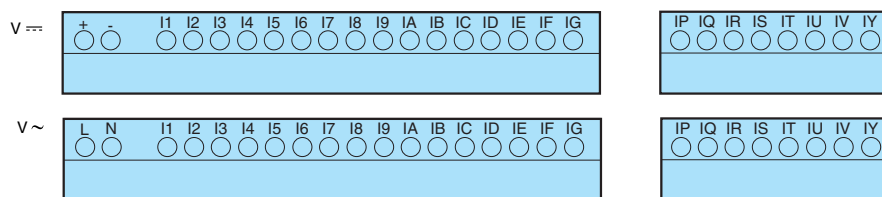

#### Sorties relais

**NB12**

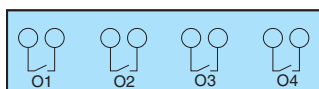

**NB20**

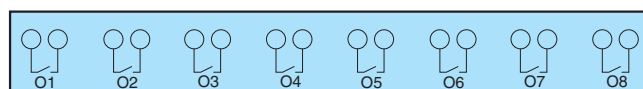

**NBR12**

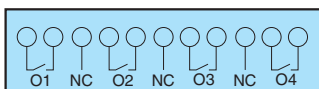

**NBR26**

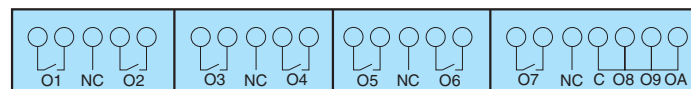

**NBR32**

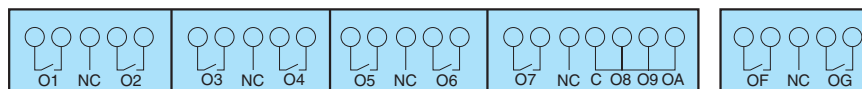

**NBR40**

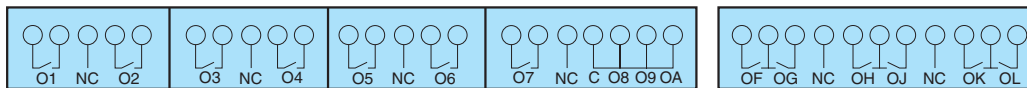

#### Solid state outputs

**NBR12**

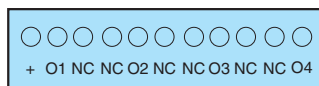

**NBR26**

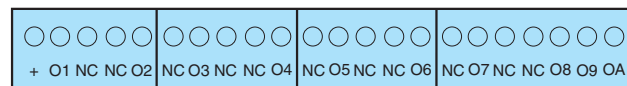

# Millenium3

More information is available on our site:

[www.millenium3.crouzet.com](http://www.millenium3.crouzet.com)

- What is a logic controller used for?
- Advantages of Millenium 3
- Product overview
- Introduction to the software
- Millenium 3 pressure solution



■ Millenium 3 Standard: Product and software offer

- Adaptation wheel
- Adapted products
- Hardware adaptations
- Custom functions
- Software adaptations



■ Millenium 3 Custom: Product and software offer

- HVAC
- Water treatment
- Renewable energies
- Industrial machines



■ Millenium 3 applications



# Web pages

- Compact range selection guide
- Expandable range selection guide
- Starter kits
- Communication solutions
- Accessories

Part	Reference	Power supply	Input	Output
88870111	88870131	24VDC	8 digital (including 4 analogue)	4 relay 8 A
88870142	88870132	24VDC	12 digital (including 4 analogue)	4 solid state 0.5 A including 1 PFM
88870143	88870133	100V ~ 24V AC	8 digital	4 relay 8 A
88870144	88870134	24VAC	8 digital	4 relay 8 A
88870161	88870151	24VDC	16 digital (including 8 analogue)	10 relay including 8 relay 8 A and 2 relay 5 A
88870162	88870152	24VDC	18 digital (including 8 analogue)	10 solid state 0.5 A including 4 PFM
88870163	88870153	100V ~ 24V AC	16 digital	10 relay including 8 relay 8 A and 2 relay 5 A
88870164	88870154	24VAC	16 digital	10 relay including 8 relay 8 A and 2 relay 5 A
88870165	88870155	12VDC	18 digital (including 8 analogue)	10 relay including 8 relay 8 A and 2 relay 5 A
88870166	-	12VDC	18 digital (including 8 analogue)	10 solid state 0.5 A (including 4 PFM)

■ Selection guide

- Download PDF documents:
  - Technical documents
  - Promotional material
  - Installation manuals
  - Demo software
  - Media gallery



■ Downloading

- Search by part number facility
- Technical data
- Diagrams:
  - Wiring
  - Dimensions
- Catalogue pages PDF

Part	Reference	Input	Output	Type
88870041	0210	8 digital of which 4 are analogue	4 relay	24 V DC
88870042	0210	8 digital of which 4 are analogue	4 solid state of which 1 is PFM	24 V DC
88870043	0210	8 digital	4 relay	100-240 V AC
88870044	0210	8 digital	4 relay	24 V AC
88870045	0210	8 digital of which 4 are	4 relay	12 V DC

■ eCatalogue: [www.catalog.crouzet.com](http://www.catalog.crouzet.com)





## FAX

From:  
Department:  
Tel.: Fax:  
E-mail:  
Date:  
Reference:  
Number of pages (including this one):

Internet: [www.millenium.crouzet.com](http://www.millenium.crouzet.com)

To: **CROUZET**

Fax: See 4th covering page

Re: Project

### DESCRIPTION OF YOUR PROJECT

Name of your application

Estimated quantity:

Why do you need a logic controller?

Application

Before project

Project to be finalised by  
(date)

Substitution

Estimated quantity:

**DETAILS OF YOUR POWER SUPPLY**

**Direct current**

- 12 V DC
- 24 V DC

**Alternating current**

- 24 V AC
- 100-240 V AC
- Frequency .....

Maximum power supply limits: .....

**YOUR SENSORS TO BE CONNECTED**

- Digital
- Analogue
  - 0-10 V
  - 0-20 mA
  - Potentiometer
  - pH
  - ORP
  - Temperature
    - NTC
    - Thermocouple
    - Pt100
    - Pt1000
- Encoder
- Other

**YOUR EQUIPMENT LOCATED AT THE OUTPUT**

- Digital outputs
  - Relays
  - Solid state
    - AC
    - DC
- PWM outputs
- Analogue outputs
  - 0-10 V

**YOUR ENVIRONMENT**

Vibrations: .....

Operating temperature: .....

Damp: .....

Degree of protection: .....

**YOUR STANDARD-RELATED CONSTRAINTS**

**YOUR WIRING CONSTRAINTS**

- Cable length:**
- 3 m
  - 10 m
- Connection using connector:**
- Yes
  - No
- Connect using wires:**
- Yes
  - No

**YOUR COMMUNICATION NEEDS**

- Network
  - Modbus
  - Ethernet - TCP/IP
- Modem
  - GSM
  - STN

**YOUR DISPLAY NEEDS**

- Remote display
  - Local display (on the product) .....
- Specific request**
- Customised marking
  - Other .....

# Millenium3

## How to order



- Millenium 3 standard products held in stock

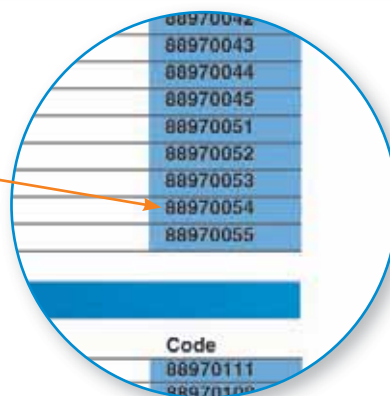

- Millenium 3 standard products that can be ordered

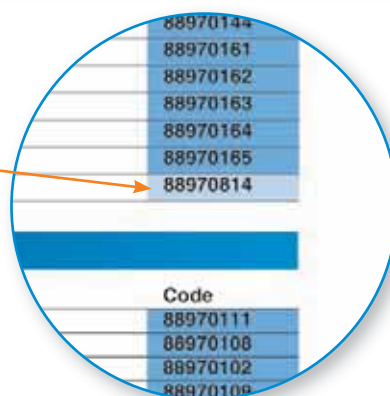

- Millenium 3 products made to specifications (contact us)

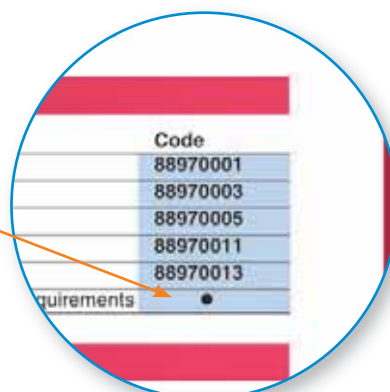

# Part numbers index

## List of part numbers

Part numbers	Name	Range name	Type	Pages
18373112	Heat transfer compound for temperature probe	Millenium 3	AS	56
26450100	Snap-on plate for 35 mm DIN rail	Millenium 3	Accessory	60
26450101	Mounting bracket	Millenium 3	Accessory	60
79696030	Thermocouple probe J - 400°C	Millenium 3	Accessory	54
79696031	Thermocouple probe J - 600°C	Millenium 3	Accessory	54
79696032	Thermocouple probe J - 400°C	Millenium 3	Accessory	54
79696033	Thermocouple probe J - 400°C	Millenium 3	Accessory	54
79696034	Thermocouple probe K - 1100°C	Millenium 3	Accessory	54
79696035	Pt100 probe Class B with stainless steel sheath	Millenium 3	Accessory	54
79696036	Pt100 probe Class B with stainless steel sheath	Millenium 3	Accessory	54
79696037	Pt100 probe Class B with aluminium V6 sheath	Millenium 3	Accessory	54
79696038	Sliding connection 1/4 Ø 3 mm	Millenium 3	Accessory	54
79696039	Sliding connection 1/4 Ø 6 mm	Millenium 3	Accessory	54
79696040	Sliding connection 1/2 Ø 3 mm	Millenium 3	Accessory	54
79696041	Sub-base 1/4 Ø 12 mm	Millenium 3	Accessory	54
79696042	Flange Ø 6 mm	Millenium 3	Accessory	54
88950105	PC link cable: USB / DB9	Millenium 3 Custom	TP	74
88950108	0-20 mA/0-10 V input signal converter	Millenium 3	AC	50
88950109	External potentiometer for value adjustment (4700 ohm)	Millenium 3	EP	49
88950112	PWM/0-10 V output signal converter	Millenium 3	AC	50
88950150	Temperature converter - Input -20 → +150°C	Millenium 3	AC	51
88950151	Temperature converter - Input -40 → +40°C	Millenium 3	AC	51
88950152	Temperature converter - Input 0 → +100°C	Millenium 3	AC	51
88950153	Temperature converter - Input 0 → +250°C	Millenium 3	AC	51
88950154	Temperature converter - Input 0 → +300°C	Millenium 3	AC	51
88950155	Temperature converter - Input 0 → +600°C	Millenium 3	AC	51
88950302	Regulated switch mode modular power supply	Millenium 3	PS 24-60 W	58-59
88950303	Regulated switch mode modular power supply	Millenium 3	PS 24-7.5 W	58-59
88950304	Regulated switch mode modular power supply	Millenium 3	PS 24-15 W	58-59
88950305	Regulated switch mode modular power supply	Millenium 3	PS 5-20 W	58-59
88950306	Regulated switch mode modular power supply	Millenium 3	PS 12-24 W	58-59
88950307	Regulated switch mode modular power supply	Millenium 3	PS 24-30 W	58-59
88950320	DC/DC converter	Millenium 3	PS 12-10 W	57
88950321	DC/DC converter	Millenium 3	PS 24-10 W	57
88950400	Remote LED display	Millenium 3	RD	48
88970001	Bare board version logic controller	Millenium 3 Custom	NB12	71
88970003	Bare board version logic controller	Millenium 3 Custom	NB12	71
88970005	Bare board version logic controller	Millenium 3 Custom	NB12	71
88970011	Bare board version logic controller	Millenium 3 Custom	NB20	71
88970013	Bare board version logic controller	Millenium 3 Custom	NB20	71
88970021	Compact version logic controller without display	Millenium 3	CB12	29
88970023	Compact version logic controller without display	Millenium 3	CB12	29
88970024	Compact version logic controller without display	Millenium 3	CB12	29
88970031	Compact version logic controller without display	Millenium 3	CB20	29

# Millenium3

Part numbers	Name	Range name	Type	Pages
88970033	Compact version logic controller without display	Millenium 3	CB20	29
88970034	Compact version logic controller without display	Millenium 3	CB20	29
88970041	Compact version logic controller with display	Millenium 3	CD12	28
88970042	Compact version logic controller with display	Millenium 3	CD12	28
88970043	Compact version logic controller with display	Millenium 3	CD12	28
88970044	Compact version logic controller with display	Millenium 3	CD12	28
88970045	Compact version logic controller with display	Millenium 3	CD12	28
88970051	Compact version logic controller with display	Millenium 3	CD20	28
88970052	Compact version logic controller with display	Millenium 3	CD20	28
88970053	Compact version logic controller with display	Millenium 3	CD20	28
88970054	Compact version logic controller with display	Millenium 3	CD20	28
88970055	Compact version logic controller with display	Millenium 3	CD20	28
88970080	Compact starter kit	Millenium 3	Kit12	28
88970081	Compact starter kit	Millenium 3	Kit12	28
88970082	Compact starter kit	Millenium 3	Kit20	28
88970083	Compact starter kit	Millenium 3	Kit20	28
88970084	Expandable starter kit	Millenium 3	Kit26	32
88970085	Expandable starter kit	Millenium 3	Kit26	32
88970094	Expandable starter kit	Millenium 3 Custom	Kit26	70
88970102	3 m serial link cable: PC => Millenium 3	Millenium 3	TP	44
88970104	Millenium 3 => Bluetooth interface (class A 10 m)	Millenium 3	TP	44
88970106	Demo case	Millenium 3	VA	27
88970108	EEPROM memory cartridge	Millenium 3	TP	44
88970109	3 m USB link cable: PC => Millenium 3	Millenium 3	TP	44
88970110	Bluetooth => USB adaptor (class A 10 m)	Millenium 3	TP	44
88970111	Multilingual programming software (CD-ROM)	Millenium 3	M3 SOFT	44
88970116	Alarm management software (CD-ROM)	Millenium 3	M3 ALARM	44
88970117	Modem communication interface	Millenium 3	M3MOD	38-39
88970118	STN modem	Millenium 3	STN	38-39
88970119	GSM modem	Millenium 3	GSM	38-39
88970123	1.80 m serial link cable: DB9/DB9	Millenium 3	TP	44
88970131	Expandable version logic controller without display	Millenium 3	XB10	33
88970132	Expandable version logic controller without display	Millenium 3	XB10	33
88970133	Expandable version logic controller without display	Millenium 3	XB10	33
88970134	Expandable version logic controller without display	Millenium 3	XB10	33
88970141	Expandable version logic controller with display	Millenium 3	XD10	32
88970142	Expandable version logic controller with display	Millenium 3	XD10	32
88970143	Expandable version logic controller with display	Millenium 3	XD10	32
88970144	Expandable version logic controller with display	Millenium 3	XD10	32
88970151	Expandable version logic controller without display	Millenium 3	XB26	33
88970152	Expandable version logic controller without display	Millenium 3	XB26	33
88970153	Expandable version logic controller without display	Millenium 3	XB26	33
88970154	Expandable version logic controller without display	Millenium 3	XB26	33
88970155	Expandable version logic controller without display	Millenium 3	XB26	33
88970161	Expandable version logic controller with display	Millenium 3	XD26	32
88970162	Expandable version logic controller with display	Millenium 3	XD26	32



# Part numbers index

Part numbers	Name	Range name	Type	Pages
88970163	Expandable version logic controller with display	Millenium 3	XD26	32
88970164	Expandable version logic controller with display	Millenium 3	XD26	32
88970165	Expandable version logic controller with display	Millenium 3	XD26	32
88970211	Digital termination extension	Millenium 3	XR06	36
88970213	Digital termination extension	Millenium 3	XR06	36
88970214	Digital termination extension	Millenium 3	XR06	36
88970215	Digital termination extension	Millenium 3	XR06	36
88970221	Digital termination extension	Millenium 3	XR10	36
88970223	Digital termination extension	Millenium 3	XR10	36
88970224	Digital termination extension	Millenium 3	XR10	36
88970225	Digital termination extension	Millenium 3	XR10	36
88970231	Digital termination extension	Millenium 3	XR14	36
88970233	Digital termination extension	Millenium 3	XR14	36
88970234	Digital termination extension	Millenium 3	XR14	36
88970235	Digital termination extension	Millenium 3	XR14	36
88970241	Analogue termination extension	Millenium 3	XA04	36
88970250	“Sandwich” communication extension	Millenium 3	XN03	34
88970270	“Sandwich” communication extension	Millenium 3	XN05	34
88970310	12 I/O removable kit for CD12 or CB12	Millenium 3	MA	44
88970311	20 I/O removable kit for CD20 or CB20	Millenium 3	MA	44
88970312	26 I/O removable kit for XD26 or XB26	Millenium 3	MA	44
88970313	Removable connectors (spring terminals) for NBR12	Millenium 3 Custom	MA	74
88970314	Removable connectors (spring terminals) for NBR26	Millenium 3 Custom	MA	74
88970315	Removable connectors (spring terminals) for NBR32	Millenium 3 Custom	MA	74
88970316	Removable connectors (spring terminals) for NBR40	Millenium 3 Custom	MA	74
88970321	Digital “Sandwich” extension	Millenium 3	XE10	35
88970323	Digital “Sandwich” extension	Millenium 3	XE10	35
88970324	Digital “Sandwich” extension	Millenium 3	XE10	35
88970410	Remote LCD screen/keypad	Millenium 3	RD	47
88970411	Remote LCD screen/keypad + 4 function keys	Millenium 3	RD	47
88970412	Kit with Remote LCD screen/keypad + Cable	Millenium 3	RD	47
88970413	Kit with Remote LCD screen/keypad + 4 function keys + Cable	Millenium 3	RD	47
88970421	Runtime kit with three-colour alphanumeric screen	Millenium 3	RD	46
88970422	Runtime kit with monochrome alphanumeric screen	Millenium 3	RD	46
88970800	3 Pt 100 “application-specific” analogue extension	Millenium 3 Custom	XA03	76-77
88970808	Kit 20 (CD20-24V DC + 24 VDC + 60W power supply)	Millenium 3 Custom	Kit 20	70
88970809	IP40 front panel adaptor for CD12 or CB12	Millenium 3	MA	45
88970810	IP40 front panel adaptor for CD20 or CB20	Millenium 3	MA	45
88970813	Kit 32 (XD26-24V DC + XR06 + 24V DC 60W power supply)	Millenium 3 Custom	Kit 32	70
88970814	Expandable version logic controller with display	Millenium 3	XD26	32
88970825	Kit 16 (XD10-24V DC + XN05 + 24V DC 30W power supply)	Millenium 3 Custom	Kit 16	70
88970840	Compact version logic controller without display	Millenium 3	CB12	29
88970844	Programming kit with monochrome alphanumeric screen	Millenium 3	RD	46
88970849	Programming kit with three-colour alphanumeric screen	Millenium 3	RD	46
88972250	“Sandwich” communication extension	Millenium 3	XN06	34
88972805	pH/ORP “application-specific” analogue extension	Millenium 3 Custom	XA04W	76-77

# Millenium3

Part numbers	Name	Range name	Type	Pages
88973001	Resin version logic controller	Millenium 3 Custom	NBR12	74-75
88973002	Resin version logic controller	Millenium 3 Custom	NBR12	74-75
88973061	Resin version logic controller	Millenium 3 Custom	NBR26	74-75
88973062	Resin version logic controller	Millenium 3 Custom	NBR26	74-75
88973063	Resin version logic controller	Millenium 3 Custom	NBR26	74-75
88973211	Resin version logic controller	Millenium 3 Custom	NBR32	74-75
88973231	Resin version logic controller	Millenium 3 Custom	NBR40	74-75
88974021	Compact version logic controller without display	Millenium 3 Custom	CB12	72-73
88974023	Compact version logic controller without display	Millenium 3 Custom	CB12	72-73
88974024	Compact version logic controller without display	Millenium 3 Custom	CB12	72-73
88974031	Compact version logic controller without display	Millenium 3 Custom	CB20	72-73
88974033	Compact version logic controller without display	Millenium 3 Custom	CB20	72-73
88974034	Compact version logic controller without display	Millenium 3 Custom	CB20	72-73
88974041	Compact version logic controller with display	Millenium 3 Custom	CD12	72-73
88974042	Compact version logic controller with display	Millenium 3 Custom	CD12	72-73
88974043	Compact version logic controller with display	Millenium 3 Custom	CD12	72-73
88974044	Compact version logic controller with display	Millenium 3 Custom	CD12	72-73
88974045	Compact version logic controller with display	Millenium 3 Custom	CD12	72-73
88974051	Compact version logic controller with display	Millenium 3 Custom	CD20	72-73
88974052	Compact version logic controller with display	Millenium 3 Custom	CD20	72-73
88974053	Compact version logic controller with display	Millenium 3 Custom	CD20	72-73
88974054	Compact version logic controller with display	Millenium 3 Custom	CD20	72-73
88974055	Compact version logic controller with display	Millenium 3 Custom	CD20	72-73
88974131	Expandable version logic controller without display	Millenium 3 Custom	XB10	72-73
88974132	Expandable version logic controller without display	Millenium 3 Custom	XB10	72-73
88974133	Expandable version logic controller without display	Millenium 3 Custom	XB10	72-73
88974134	Expandable version logic controller without display	Millenium 3 Custom	XB10	72-73
88974141	Expandable version logic controller with display	Millenium 3 Custom	XD10	72-73
88974142	Expandable version logic controller with display	Millenium 3 Custom	XD10	72-73
88974143	Expandable version logic controller with display	Millenium 3 Custom	XD10	72-73
88974144	Expandable version logic controller with display	Millenium 3 Custom	XD10	72-73
88974151	Expandable version logic controller without display	Millenium 3 Custom	XB26	72-73
88974152	Expandable version logic controller without display	Millenium 3 Custom	XB26	72-73
88974153	Expandable version logic controller without display	Millenium 3 Custom	XB26	72-73
88974154	Expandable version logic controller without display	Millenium 3 Custom	XB26	72-73
88974155	Expandable version logic controller without display	Millenium 3 Custom	XB26	72-73
88974161	Expandable version logic controller with display	Millenium 3 Custom	XD26	72-73
88974162	Expandable version logic controller with display	Millenium 3 Custom	XD26	72-73
88974163	Expandable version logic controller with display	Millenium 3 Custom	XD26	72-73
88974164	Expandable version logic controller with display	Millenium 3 Custom	XD26	72-73
88974165	Expandable version logic controller with display	Millenium 3 Custom	XD26	72-73
89210001	Capacitive pressure transmitter: Relative 0 to 0.25b	Millenium 3	AS	52-53
89210002	Capacitive pressure transmitter: Relative 0 to 1b	Millenium 3	AS	52-53
89210003	Capacitive pressure transmitter: Relative 0 to 2.5b	Millenium 3	AS	52-53
89210004	Capacitive pressure transmitter: Relative 0 to 10b	Millenium 3	AS	52-53
89210005	Capacitive pressure transmitter: Relative 0 to 25b	Millenium 3	AS	52-53

# Part numbers index

Part numbers	Name	Range name	Type	Pages
89210006	Capacitive pressure transmitter: Relative 0 to 60b	Millenium 3	AS	52-53
89210007	Capacitive pressure transmitter: Absolute 0 to 1b	Millenium 3	AS	52-53
89210008	Capacitive pressure transmitter: Absolute 0 to 2.5b	Millenium 3	AS	52-53
89210009	Capacitive pressure transmitter: Absolute 0 to 10b	Millenium 3	AS	52-53
89210010	Capacitive pressure transmitter: Absolute 0 to 25b	Millenium 3	AS	52-53
89210011	Capacitive pressure transmitter: Absolute 0 to 100b	Millenium 3	AS	52-53
89450110	Regulated switch mode equipment power supply	Millenium 3	89450 without PFC	60-61
89450122	Regulated switch mode equipment power supply	Millenium 3	89450 with PFC	60-61
89450210	Regulated switch mode equipment power supply	Millenium 3	89450 without PFC	60-61
89450221	Regulated switch mode equipment power supply	Millenium 3	89450 without PFC	60-61
89450222	Regulated switch mode equipment power supply	Millenium 3	89450 with PFC	60-61
89450231	Regulated switch mode equipment power supply	Millenium 3	89450 without PFC	60-61
89450232	Regulated switch mode equipment power supply	Millenium 3	89450 with PFC	60-61
89450241	Regulated switch mode equipment power supply	Millenium 3	89450 without PFC	60-61
89450242	Regulated switch mode equipment power supply	Millenium 3	89450 with PFC	60-61
89750146	Copper protective sleeve for temperature probe	Millenium 3	AS	56
89750147	Stainless steel 316 protective sleeve for temperature probe	Millenium 3	AS	56
89750150	Room temperature transmitter	Millenium 3	AS	56
89750151	Ventilation duct temperature transmitter	Millenium 3	AS	56
89750152	Outdoor temperature transmitter	Millenium 3	AS	56
89750153	Remote/submersible temperature transmitter	Millenium 3	AS	56
89750155	Remote/submersible temperature transmitter	Millenium 3	AS	56
89750160	IP67 sealed faceplate adaptor (76.5 mm)	Millenium 3	MA	45
89750161	IP67 sealed faceplate adaptor (147.5 mm)	Millenium 3	MA	45
89750162	IP67 sealed faceplate adaptor (248.5 mm)	Millenium 3	MA	45
89750170	pH BNC probe	Millenium 3 Custom	AS	78
89750171	pH ferrules probe	Millenium 3 Custom	AS	78
89750172	ORP BNC probe	Millenium 3 Custom	AS	78
89750173	ORP ferrules probe	Millenium 3 Custom	AS	78
89750180	24 V DC NTC probe for Millenium 3 (pack of 10)	Millenium 3	AS	79
89750181	24 V DC NTC probe for Millenium 3 (pack of 100)	Millenium 3	AS	79



## AMERICA

### BRAZIL

**CST Latinoamerica**  
Alameda Rio Negro,  
1.084 - cj,A31  
Centro Empresarial de Alphaville  
CEP: 06454-000 Barueri - SP  
BRASIL  
Tel. : +55 (11) 4191 9797  
Fax : +55 (11) 4191 9136  
E-mail : info@cst-latinoamerica.com  
www.crouzet.com.br

### MEXICO

**Automatismo Crouzet S.A. de C.V.**  
Calzada Zavaleta 2505 - C  
Col Sta Cruz Buenavista  
C.P. 72150 - Puebla  
MEXICO  
Tel. : +52 (222) 409 7000  
Fax : +52 (222) 409 7810  
01 800 087 6333  
E-mail : info-crouzet.mexicana@us.crouzet.com  
www.crouzet.com

### USA/CANADA

**Crouzet North America**  
204 Airline Drive, suite 300  
75019 Coppell Texas  
USA  
Tel. : +1 (800) 677 5311  
Fax : +1 (972) 471 2560  
E-mail : customerservice@us.crouzet.com  
www.crouzet-usa.com

### OTHER COUNTRIES

**Crouzet do Brasil Ltda**  
Rua Gal.Furtado Nascimento,  
740 - sala 77  
Alto de Pinheiros / 05465-070  
BRASIL  
Tel. : +55 (11) 3026 9008  
Fax : +55 (11) 3026 9009  
E-mail : crz-infobrasil@crouzet.com  
www.crouzet.com.br

## EUROPE MIDDLE EAST AFRICA

### AUSTRIA

**Crouzet GmbH**  
Zweigniederlassung Österreich  
Spengergasse 1/3  
1050 Wien  
ÖSTERREICH  
Tel. : +43 (0) 1 36 85 471  
Fax : +43 (0) 1 36 85 472  
E-mail : info-direkt@crouzet.com  
www.crouzet.at

### BELGIUM

**Crouzet NV/SA**  
Dieweg 3 B  
B - 1180 Uccle  
BELGIUM  
Tel. : +32 (0) 2 462 07 30  
Fax : +32 (0) 2 461 00 23  
E-mail : com-be@crouzet.com  
www.crouzet.be

### FRANCE

**Crouzet Automatismes SAS**  
2 rue du Docteur Abel - BP 59  
26902 Valence CEDEX 9  
FRANCE  
Tel. : +33 (0) 4 75 44 88 44  
Fax : +33 (0) 4 75 55 98 03  
E-mail : com-fr@crouzet.com  
www.crouzet.fr

#### Customer service

 N° Indigo 0 825 333 350

 N° Azur Fax 0 810 610 102

### GERMANY

**Crouzet GmbH**  
Otto-Hahn-Str. 3, 40721 Hilden  
Postfach 203, 40702 Hilden  
DEUTSCHLAND  
E-mail : info-direkt@crouzet.com  
www.crouzet.de

#### Customer service

Tel. : +49 (0) 21 03 9 80-108/176  
Fax : +49 (0) 21 03 9 80-250  
E-mail : info-direkt@crouzet.com

### ITALY

**Crouzet Componenti s.r.l.**  
Via Viganò De Vizzi, 93/95  
20092 Cinisello Balsamo (MI)  
ITALIA  
Tel. : +39 (02) 66 599 220  
Fax : +39 (02) 66 599 228  
E-mail : crz-it-microcontrol@crouzet.com  
www.crouzet.it

### SPAIN/PORTUGAL

**Crouzet Ibérica**  
C/ Aragón 224, 2º 2ª  
08011 Barcelona  
ESPAÑA  
Tel. : +34 (93) 484 39 70  
Fax : +34 (93) 484 39 73  
E-mail : es-consultas@crouzet.es  
www.crouzet.es

### THE NETHERLANDS

**Crouzet BV**  
Industrieweg 17  
2382 NR Zoeterwoude  
NEDERLAND  
Tel. : +31 (0) 71-581 20 30  
Fax : +31 (0) 71-541 35 74  
E-mail : com-nl@crouzet.com  
www.crouzet.nl

### UNITED KINGDOM

**Crouzet Ltd**  
Intec 3 Wade Road  
Basingstoke Hampshire  
RG24 8NE  
UNITED KINGDOM  
Tel. : +44 (0)1256 318 900  
Fax : +44 (0)1256 318 901  
E-mail : info@crouzet.co.uk  
www.crouzet.co.uk

### SWITZERLAND

**Crouzet AG**  
Gewerbepark - Postfach 56  
5506 Mägenwil  
SCHWEIZ  
Tel. : +41(0) 62 887 30 30  
Fax : +41(0) 62 887 30 40  
E-mail : info-direkt@crouzet.com  
www.crouzet.ch

### OTHER COUNTRIES

**Crouzet Automatismes SAS**  
2 rue du Docteur Abel - BP 59  
26902 Valence CEDEX 9  
FRANCE  
Tel. : +33 (0) 475 802 102  
Fax : +33 (0) 475 448 126  
E-mail : com-ex@crouzet.com  
www.crouzet.com

## ASIA PACIFIC

### CHINA & HONG-KONG

**Custom Sensors & Technologies Asia (Shanghai) Limited**  
2 Floor, Innovation Building  
No. 1009, Yi Shan Road  
Shanghai 200233  
CHINA  
Tel. : +86 (21) 2401 7766  
Fax : +86 (21) 6249 0701  
E-mail : com-cn@cn.crouzet.com  
www.crouzet.cn

### INDIA

**Crouzet India**  
Prestige Meridian II  
No. 30, 13th Floor,  
Unit No: 1301 & 1302  
Mahatma Gandhi Road  
Bangalore 560 001  
INDIA  
Tel. : +91 (0) 80 41132204/05  
Fax : +91 (80) 41132206  
E-mail : crz\_bangalore@crouzet.com  
www.crouzet.co.in

### TAIWAN

**Custom Sensors & Technologies**  
3F, No. 39, Ji-Hu Road  
Nei-Hu Dist. - Taipei 114  
TAIWAN  
Tel. : +886 2 8751 6388  
Fax : +886 2 2657 8725  
E-mail : com-tw@tw.crouzet.com  
www.crouzet.tw

### SOUTH KOREA

**Custom Sensors & Technologies**  
5F, Jeil Bldg.  
94-46 Youngdeungpo-dong  
7- ga Youngdeungpo-gu  
Seoul, 150-037  
SOUTH KOREA  
Tel. : +82 2 2629 8312  
Fax : +82 2 2629 8310  
E-mail : com-tw@tw.crouzet.com  
www.crouzet.com

### OTHER ASIAN & PACIFIC COUNTRIES

**Custom Sensors & Technologies**  
3F, No. 39, Ji-Hu Road  
Nei-Hu Dist. - Taipei 114  
TAIWAN  
Tel. : +886 2 8751 6388  
Fax : +886 2 2657 8725  
E-mail : com-tw@tw.crouzet.com  
www.crouzet.com

#### Warning:

The product information contained in this catalogue is given purely as information and does not constitute a representation, warranty or any form of contractual commitment. CROUZET Automatismes and its subsidiaries reserve the right to modify their products without notice. It is imperative that we should be consulted over any particular use or application of our products and it is the responsibility of the buyer to establish, particularly through all the appropriate tests, that the product is suitable for the use or application. Under no circumstances will our warranty apply, nor shall we be held responsible for any application (such as any modification, addition, deletion, use in conjunction with other electrical or electronic components, circuits or assemblies, or any other unsuitable material or substance) which has not been expressly agreed by us prior to the sale of our products.

Headquartered in Moorpark, California-USA, **Custom Sensors & Technologies (CST)** is made up of the leading brands of Crouzet, Kavlico and Crydom, as well as the former divisions of BEI Technologies, including Newall and Systron Donner. CST provides sensors, controls, and actuation products to the transportation, industrial, and aerospace & defense markets.

[www.cstsensors.com](http://www.cstsensors.com)

Distributed by:

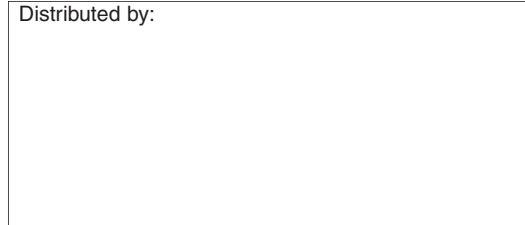

### Crouzet Automatismes SAS

2 rue du Docteur Abel - BP 59  
26902 Valence CEDEX 9  
FRANCE

[www.crouzet.com](http://www.crouzet.com)

CRZ BR 32/C EN  
Ref. 6719115 EN  
08/2008

Creation-Design: Communication Crouzet  
Editing-Publishing: Link to Business, 3C Evolution, Axess  
Photos-Graphics: Daniel Lattard, Schneider Electric, Ginko  
Printing: Imprimerie des Deux Ponts



Компания «ЭлектроПласт» предлагает заключение долгосрочных отношений при поставках импортных электронных компонентов на взаимовыгодных условиях!

Наши преимущества:

- Оперативные поставки широкого спектра электронных компонентов отечественного и импортного производства напрямую от производителей и с крупнейших мировых складов;
- Поставка более 17-ти миллионов наименований электронных компонентов;
- Поставка сложных, дефицитных, либо снятых с производства позиций;
- Оперативные сроки поставки под заказ (от 5 рабочих дней);
- Экспресс доставка в любую точку России;
- Техническая поддержка проекта, помощь в подборе аналогов, поставка прототипов;
- Система менеджмента качества сертифицирована по Международному стандарту ISO 9001;
- Лицензия ФСБ на осуществление работ с использованием сведений, составляющих государственную тайну;
- Поставка специализированных компонентов (Xilinx, Altera, Analog Devices, Intersil, Interpoint, Microsemi, Aeroflex, Peregrine, Syfer, Eurofarad, Texas Instrument, Miteq, Cobham, E2V, MA-COM, Hittite, Mini-Circuits, General Dynamics и др.);

Помимо этого, одним из направлений компании «ЭлектроПласт» является направление «Источники питания». Мы предлагаем Вам помощь Конструкторского отдела:

- Подбор оптимального решения, техническое обоснование при выборе компонента;
- Подбор аналогов;
- Консультации по применению компонента;
- Поставка образцов и прототипов;
- Техническая поддержка проекта;
- Защита от снятия компонента с производства.



#### Как с нами связаться

**Телефон:** 8 (812) 309 58 32 (многоканальный)

**Факс:** 8 (812) 320-02-42

**Электронная почта:** [org@eplast1.ru](mailto:org@eplast1.ru)

**Адрес:** 198099, г. Санкт-Петербург, ул. Калинина, дом 2, корпус 4, литера А.