

■ OUTLINE

The R1223N Series are PWM step-down DC/DC Converter controllers with low supply current by CMOS process.

Each of these ICs consists of an oscillator, a PWM control circuit, a reference voltage unit, an error amplifier, a soft-start circuit, a protection circuit, a PWM/VFM alternative circuit, a chip enable circuit, and resistors for voltage detection. A low ripple, high efficiency step-down DC/DC converter can be easily composed of this IC with only four external components, or a power-transistor, an inductor, a diode and a capacitor.

With a PWM/VFM alternative circuit, when the load current is small, the operation is automatically switching into the VFM oscillator from PWM oscillator, therefore the efficiency at small load current is improved. The R1223N XXXB type, which is without a PWM/VFM alternative circuit, is also available.

If the term of maximum duty cycle keeps on a certain time, the embedded protection circuit works. There are two types of protection function. One is latch-type protection circuit, and it works to latch an external Power MOSFET with keeping it disable. To release the condition of protection, after disable this IC with a chip enable circuit, enable it again, or restart this IC with power-on. The other is Reset-type protection circuit, and it works to restart the operation with soft-start and repeat this operation until maximum duty cycle condition is released. Either of these protection circuits can be designated by users' request.

■ FEATURES

- Range of Input Voltage 2.3V~13.2V
- Built-in Soft-start Function and Two choices of Protection Function (Latch-type or Reset type)
- Two choices of Oscillator Frequency 300kHz, 500kHz
- High Efficiency TYP. 90%
- Output Voltage Stepwise Setting with a step of 0.1V
in the range of 1.5V ~ 5.0V
- Standby Current TYP. 0μA
- High Accuracy Output Voltage ±2.0%
- Low Temperature-Drift Coefficient of Output Voltage TYP. ±100ppm/°C

■ APPLICATIONS

- Power source for hand-held communication equipment, cameras, video instruments such as VCRs, camcorders.
- Power source for battery-powered equipment.
- Power source for household electrical appliances.

■ BLOCK DIAGRAM

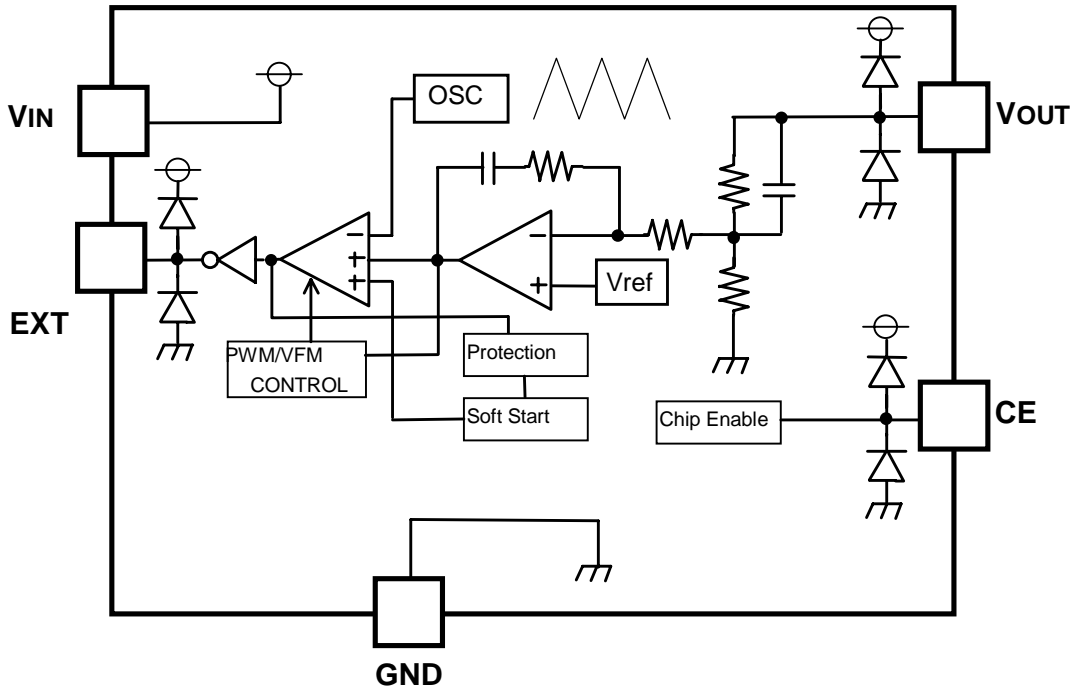

■ SELECTION GUIDE

In the R1223N Series, the output voltage, the oscillator frequency, the optional function, and the taping type for the ICs can be selected at the user's request.

The selection can be made by designating the part number as shown below;

R1223NXXXX-XX

↑ ↑ ↑ ↑
a b c d

Code	Contents
a	Setting Output Voltage(VOUT): Stepwise setting with a step of 0.1V in the range of 1.5V to 5.0V is possible.
b	Designation of Oscillator Frequency 2 : fixed
c	Designation of Optional Function A : 300kHz, with a PWM/VFM alternative circuit, Latch-type protection B : 500 kHz, with a PWM/VFM alternative circuit, Latch-type protection C : 300kHz, without a PWM/VFM alternative circuit, Latch-type protection D : 500kHz, without a PWM/VFM alternative circuit, Latch-type protection E : 300kHz, with a PWM/VFM alternative circuit, Reset-type protection F : 500 kHz, with a PWM/VFM alternative circuit, Reset-type protection G : 300kHz, without a PWM/VFM alternative circuit, Reset-type protection H : 500kHz, without a PWM/VFM alternative circuit, Reset-type protection
d	Designation of Taping Type; Ex. :TR,TL(refer to Taping Specification) "TR" is prescribed as a standard.

■ PIN CONFIGURATION

● SOT-23-5

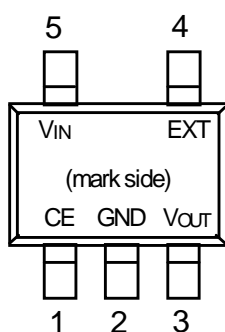

■ PIN DESCRIPTION

Pin No.	Symbol	Description
1	CE	Chip Enable Pin
2	GND	Ground Pin
3	VOUT	Pin for Monitoring Output Voltage
4	EXT	External Transistor Drive Pin
5	VIN	Power Supply Pin

■ ABSOLUTE MAXIMUM RATINGS

Symbol	Item	Rating	Unit
VIN	VIN Supply Voltage	15	V
VEXT	EXT Pin Output Voltage	-0.3~VIN+0.3	V
VCE	CE Pin Input Voltage	-0.3~VIN+0.3	V
VOUT	VOUT Pin Input Voltage	-0.3~VIN+0.3	V
IEXT	EXT Pin Inductor Drive Output Current	±25	mA
PD	Power Dissipation	250	mW
Topt	Operating Temperature Range	-40~+85	°C
Tstg	Storage Temperature Range	-55~+125	°C

■ ELECTRICAL CHARACTERISTICS

●R1223N**2A(C,E,G) Output Voltage : Vo

(Topt=25°C)

Symbol	Item	Conditions	MIN.	TYP.	MAX.	Unit
V _{IN}	Operating Input Voltage		2.3		13.2	V
V _{OUT}	Step-down Output Voltage	V _{IN} =V _{CE} =V _o +1.2V, I _{OUT} =-10mA	V _o × 0.98	V _o	V _o × 1.02	V
ΔV _{OUT} / ΔT	Step-down Output Voltage Temperature Coefficient	-40°C ≤ Topt ≤ 85°C		±100		ppm /°C
f _{osc}	Oscillator Frequency	V _{IN} =V _{CE} =V _o +1.2V, I _{OUT} =-100mA	240	300	360	kHz
Δf _{osc} / ΔT	Oscillator Frequency Temperature Coefficient	-40°C ≤ Topt ≤ 85°C		±0.3		% /°C
I _{DD1}	Supply Current1	V _{IN} =13.2V, V _{CE} =13.2V, V _{OUT} =13.2V		100	160	μA
I _{stb}	Standby Current	V _{IN} =13.2V, V _{CE} =0V, V _{OUT} =0V		0	0.5	μA
I _{EXTH}	EXT "H" Output Current	V _{IN} =8V, V _{EXT} =7.9V, V _{OUT} =8V, V _{CE} =8V		-10	-6	mA
I _{EXTL}	EXT "L" Output Current	V _{IN} =8V, V _{EXT} =0.1V, V _{OUT} =0V, V _{CE} =8V	10	20		mA
I _{CEH}	CE "H" Input Current	V _{IN} =13.2V, V _{CE} =13.2V, V _{OUT} =13.2V		0	0.5	μA
I _{CEL}	CE "L" Input Current	V _{IN} =13.2V, V _{CE} =0V, V _{OUT} =13.2V	-0.5	0		μA
V _{CEH}	CE "H" Input Voltage	V _{IN} =8V, V _{OUT} =0V→1.5V		0.8	1.2	V
V _{CEL}	CE "L" Input Voltage	V _{IN} =8V, V _{OUT} =1.5V→0V	0.3	0.8		V
Maxdty	Oscillator Maximum Duty Cycle		100			%
VFMdty	VFM Duty Cycle	only for A, E version		25		%
T _{start}	Delay Time by Soft-Start function	V _{IN} = V _o +1.2V, V _{CE} =0V→V _o +1.2V specified at 80% for rising edge	5	10	16	ms
T _{prot}	Delay Time for protection circuit	V _{IN} =V _{CE} =V _o +1.2V V _{OUT} = V _o +1.2V→0V	1	3	5	ms

●R1223N**2B(D,F,H) Output Voltage : Vo

(Topt=25°C)

Symbol	Item	Conditions	MIN.	TYP.	MAX.	Unit
VIN	Operating Input Voltage		2.3		13.2	V
VOUT	Step-down Output Voltage	VIN=VCE=Vo+1.2V, IOUT=-10mA	Vo× 0.98	Vo	Vo× 1.02	V
ΔVOUT/ ΔT	Step-down Output Voltage Temperature Coefficient	-40°C ≤ Topt ≤ 85°C		±100		ppm /°C
fosc	Oscillator Frequency	VIN=VCE=Vo+1.2V, IOUT=-100mA	400	500	600	kHz
ΔfOSC/ ΔT	Oscillator Frequency Temperature Coefficient	-40°C ≤ Topt ≤ 85°C		±0.3		% /°C
IDD1	Supply Current1	VIN=13.2V, VCE=13.2V, VOUT=13.2V		140	200	μA
Istb	Standby Current	VIN=13.2V, VCE=0V, VOUT=0V		0	0.5	μA
IEXTH	EXT "H" Output Current	VIN=8V, VEXT=7.9V, VOUT=8V, VCE=8V		-10	-6	mA
IEXTL	EXT "L" Output Current	VIN=8V, VEXT=0.1V, VOUT=0V, VCE=8V	10	20		mA
ICEH	CE "H" Input Current	VIN=13.2V, VCE=13.2V, VOUT=13.2V		0	0.5	μA
ICEL	CE "L" Input Current	VIN=13.2V, VCE=0V, VOUT=13.2V	-0.5	0		μA
VCEH	CE "H" Input Voltage	VIN=8V, VOUT=0V→1.5V		0.8	1.2	V
VCEL	CE "L" Input Voltage	VIN=8V, VOUT=1.5V→0V	0.3	0.8		V
Maxdty	Oscillator Maximum Duty Cycle		100			%
VFMdty	VFM Duty Cycle	only for B, F version		25		%
Tstart	Delay Time by Soft-Start function	VIN= Vo+1.2V, VCE=0V→ Vo+1.2V specified at 80% for rising edge	3	6	10	ms
Tprot	Delay Time for protection circuit	VIN=VCE=Vo+1.2V VOUT= Vo+1.2V→0V	1	2	4	ms

■ TEST CIRCUITS

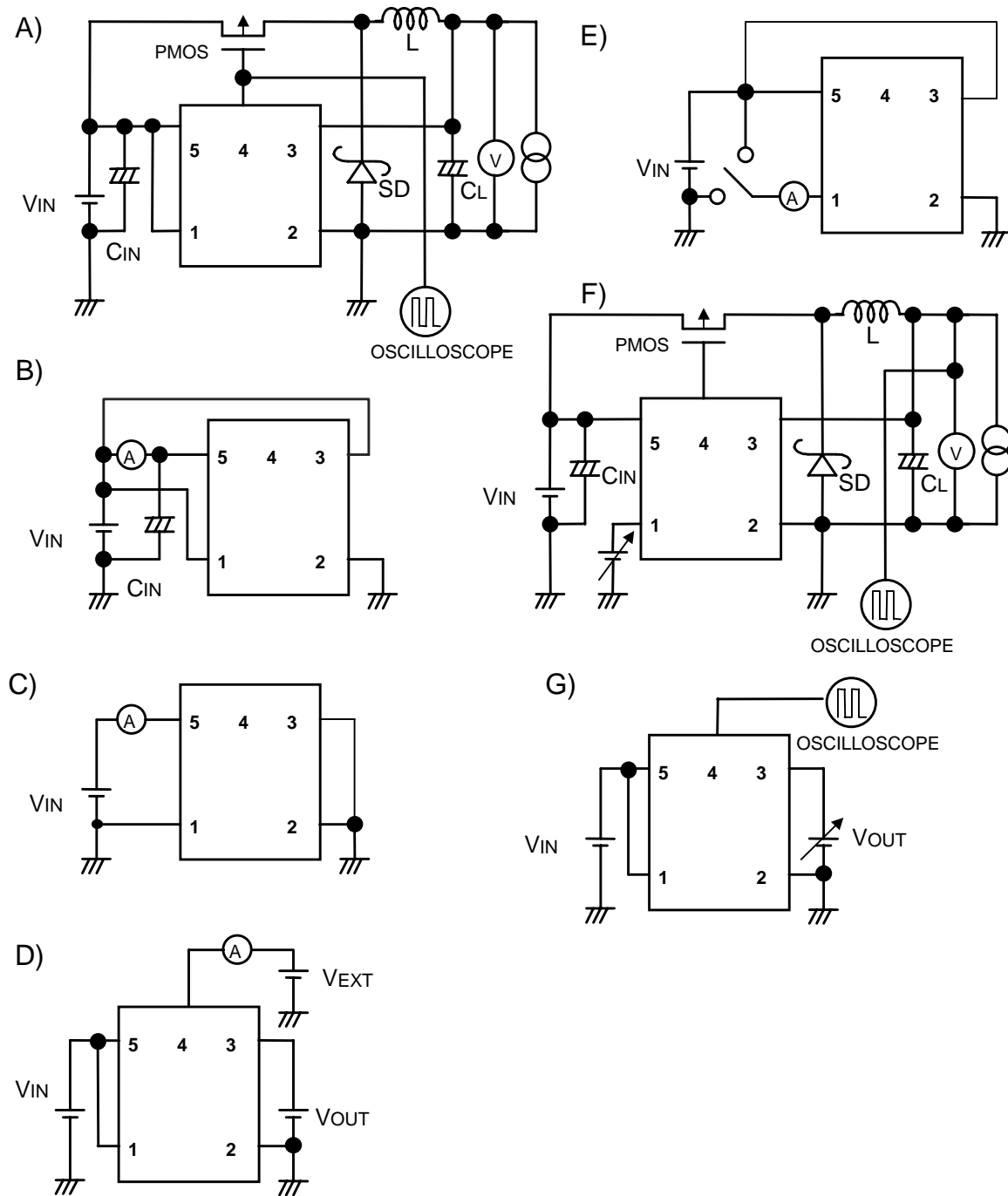

The typical characteristics were obtained by use of these test circuits.

Test Circuit A : Typical characteristics 1), 2), 3), 4), 5), 6), 7)

Test Circuit B : Typical characteristics 8)

Test Circuit C : Standby Current

Test Circuit D : Typical characteristics 12), 13)

Test Circuit E : CE input current "H" and "L"

Test Circuit F : Typical characteristics 9)

Test Circuit G : Typical characteristics 10), 11)

Use an inductor with appropriate inductance.

- Use a diode of a Schottky type with high switching speed, and also pay attention to its current capacity.
- Do not use this IC under the condition at V_{IN} voltage less than minimum operating voltage.

☆ The performance of power source circuits using these ICs extremely depends upon the peripheral circuits. Pay attention in the selection of the peripheral circuits. In particular, design the peripheral circuits in a way that the values such as voltage, current, and power of each component, PCB patterns and the IC do not exceed their respected rated values.

■ OPERATION of step-down DC/DC converter and Output Current

The step-down DC/DC converter charges energy in the inductor when Lx transistor is ON, and discharges the energy from the inductor when Lx transistor is OFF and controls with less energy loss, so that a lower output voltage than the input voltage is obtained. The operation will be explained with reference to the following diagrams :

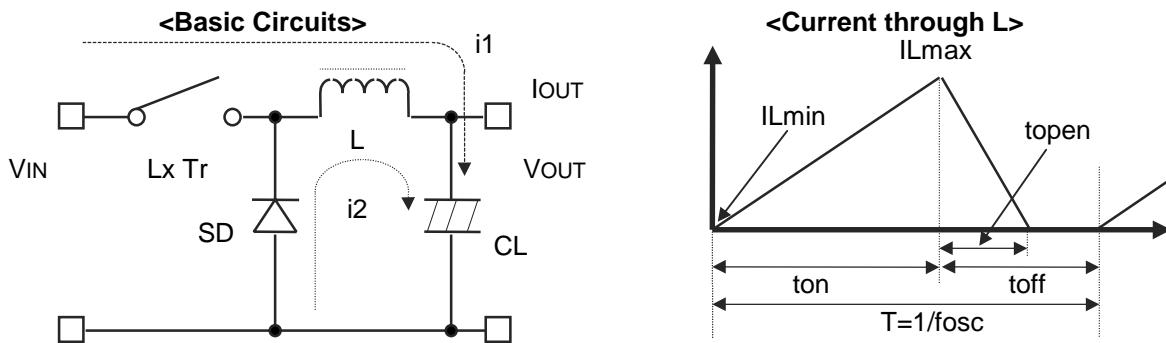

- Step 1 : LxTr turns on and current $I_L (=i_1)$ flows, and energy is charged into CL. At this moment, I_L increases from $I_{Lmin} (=0)$ to reach I_{Lmax} in proportion to the on-time period(t_{on}) of LXTr.
- Step 2 : When LxTr turns off, Schottky diode(SD) turns on in order that L maintains I_L at I_{Lmax} , and current $I_L (=i_2)$ flows.
- Step 3 : I_L decreases gradually and reaches I_{Lmin} after a time period of t_{open} , and SD turns off, provided that in the continuous mode, next cycle starts before I_L becomes to 0 because t_{off} time is not enough. In this case, I_L value is from this $I_{Lmin} (>0)$.

In the case of PWM control system, the output voltage is maintained by controlling the on-time period(t_{on}), with the oscillator frequency(f_{osc}) being maintained constant.

● Discontinuous Conduction Mode and Continuous Conduction Mode

The maximum value(I_{Lmax}) and the minimum value(I_{Lmin}) of the current which flows through the inductor are the same as those when LxTr is ON and when it is OFF.

The difference between I_{Lmax} and I_{Lmin} , which is represented by ΔI ;

$$\Delta I = I_{Lmax} - I_{Lmin} = V_{OUT} \times t_{open} / L = (V_{IN} - V_{OUT}) \times t_{on} / L \dots \text{Equation 1}$$

wherein $T = 1/f_{osc} = t_{on} + t_{off}$

$$\text{duty}(\%) = t_{on} / T \times 100 = t_{on} \times f_{osc} \times 100$$

$$t_{open} \leq t_{off}$$

In Equation 1, $V_{OUT} \times t_{open} / L$ and $(V_{IN} - V_{OUT}) \times t_{on} / L$ are respectively show the change of the current at ON, and the change of the current at OFF.

When the output current(I_{OUT}) is relatively small, $t_{open} < t_{off}$ as illustrated in the above diagram. In this case, the energy is charged in the inductor during the time period of t_{on} and is discharged in its entirety during the time period of t_{off} , therefore I_{Lmin} becomes to zero($I_{Lmin} = 0$). When I_{OUT} is gradually increased, eventually, t_{open} becomes to t_{off} ($t_{open} = t_{off}$), and when I_{OUT} is further increased, I_{Lmin} becomes larger than zero($I_{Lmin} > 0$). The former mode is referred to as the discontinuous mode and the latter mode is referred to as continuous mode.

In the continuous mode, when Equation 1 is solved for t_{on} and assumed that the solution is t_{onc} ,

$$t_{on} = T \times V_{IN} / V_{OUT} \dots \text{Equation 2}$$

When $t_{on} < t_{onc}$, the mode is the discontinuous mode, and when $t_{on} = t_{onc}$, the mode is the continuous mode.

■ OUTPUT CURRENT AND SELECTION OF EXTERNAL COMPONENTS

When LxTr is ON:

(Wherein, Ripple Current P-P value is described as IRP, ON resistance of LXTr is described as Rp the direct current of the inductor is described as RL.)

$$V_{IN} = V_{OUT} + (R_p + R_L) \times I_{OUT} + L \times I_{RP} / t_{on} \dots \text{Equation 3}$$

When LxTr is OFF:

$$L \times I_{RP} / t_{off} = V_F + V_{OUT} + R_L \times I_{OUT} \dots \text{Equation 4}$$

Put Equation 4 to Equation 3 and solve for ON duty, $t_{on} / (t_{off} + t_{on}) = D_{ON}$,

$$D_{ON} = (V_{OUT} + V_F + R_L \times I_{OUT}) / (V_{IN} + V_F - R_p \times I_{OUT}) \dots \text{Equation 5}$$

Ripple Current is as follows;

$I_{RP} = (V_{IN} - V_{OUT} - R_p \times I_{OUT} - R_L \times I_{OUT}) \times D_{ON} / f / L \dots \text{Equation 6}$
wherein, peak current that flows through L, LxTr, and SD is as follows;

$$I_{Lmax} = I_{OUT} + I_{RP} / 2 \dots \text{Equation 7}$$

Consider ILmax, condition of input and output and select external components.

★The above explanation is directed to the calculation in an ideal case in continuous mode.

■ External Components

1. Inductor

Select an inductor that peak current does not exceed ILmax. If larger current than allowable current flows, magnetic saturation occurs and make transform efficiency worse.

When the load current is same, the smaller value of L, the larger the ripple current.

Provided that the allowable current is large in that case and DC current is small, therefore, for large output current, efficiency is better than using an inductor with a large value of L and vice versa.

2. Diode

Use a diode with low VF (Schottky type is recommended.) and high switching speed.

Reverse voltage rating should be more than VIN and current rating should be equal or more than ILmax.

3. Capacitor

As for CIN, use a capacitor with low ESR(Equivalent Series Resistance) and a capacity of at least 10μF for stable operation.

COUt can reduce ripple of Output Voltage, therefore 47 to 100μF tantalum type is recommended.

4. Lx Transistor

Pch Power MOS FET is required for this IC.

Its breakdown voltage between gate and source should be a few volt higher than Input Voltage.

In the case of Input Voltage is low, to turn on MOS FET completely, select a MOS FET with low threshold voltage.

If a large load current is necessary for your application and important, choose a MOS FET with low ON resistance for good efficiency.

If a small load current is mainly necessary for your application, choose a MOS FET with low gate capacity for good efficiency.

Maximum continuous drain current of MOS FET should be larger than peak current, ILmax.

■ TYPICAL CHARACTERISTICS

1) Output Voltage vs. Output Current

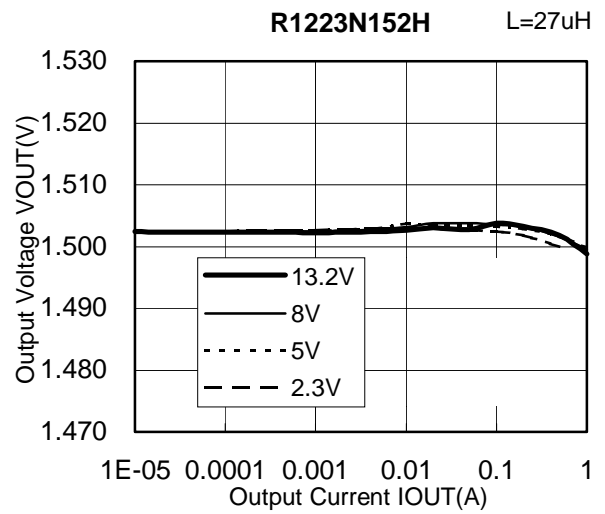
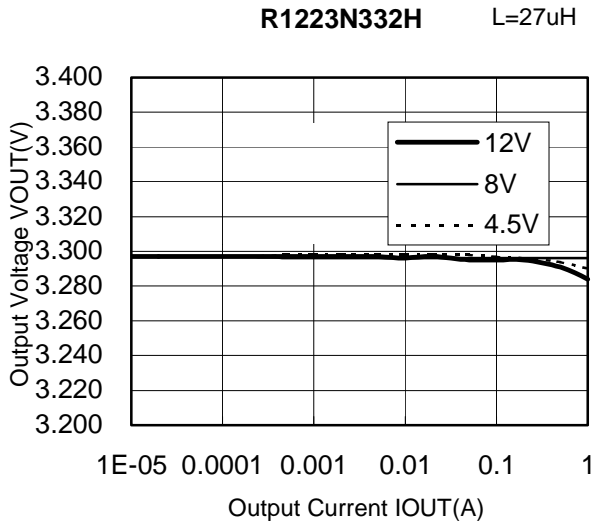

2) Efficiency vs. Output Current

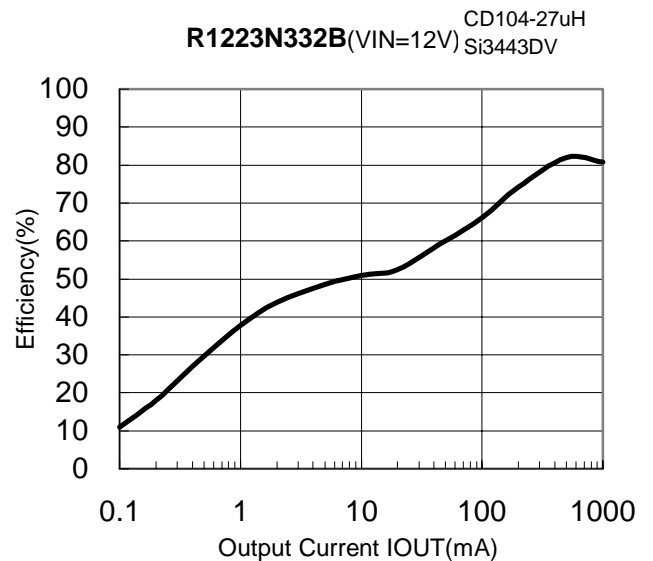
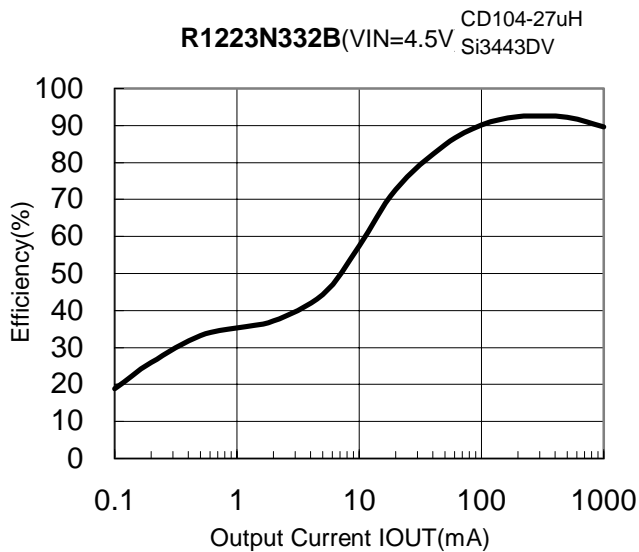
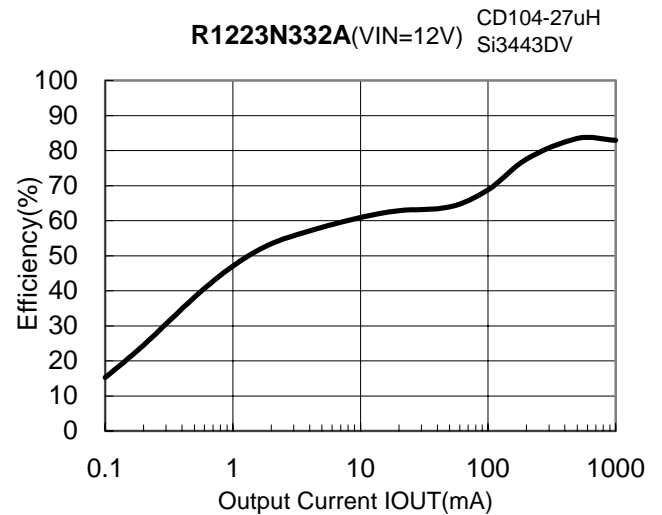
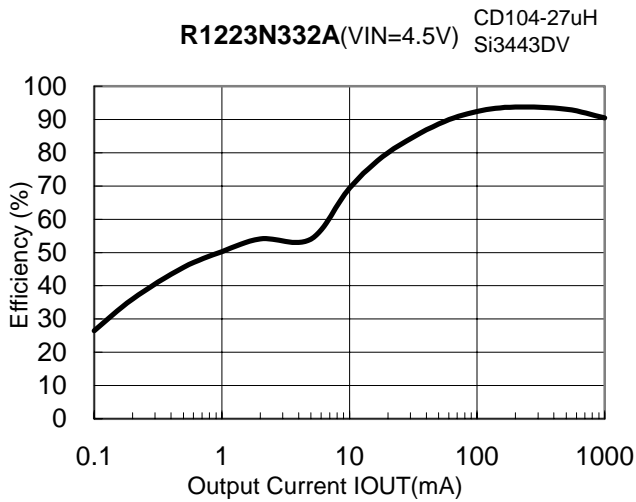

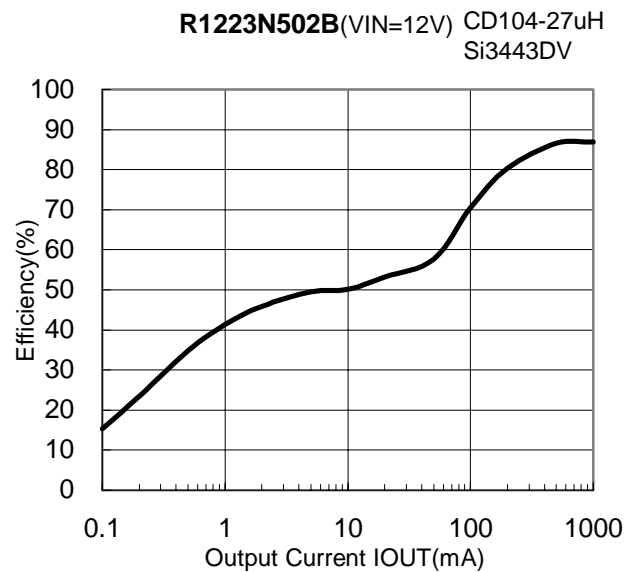
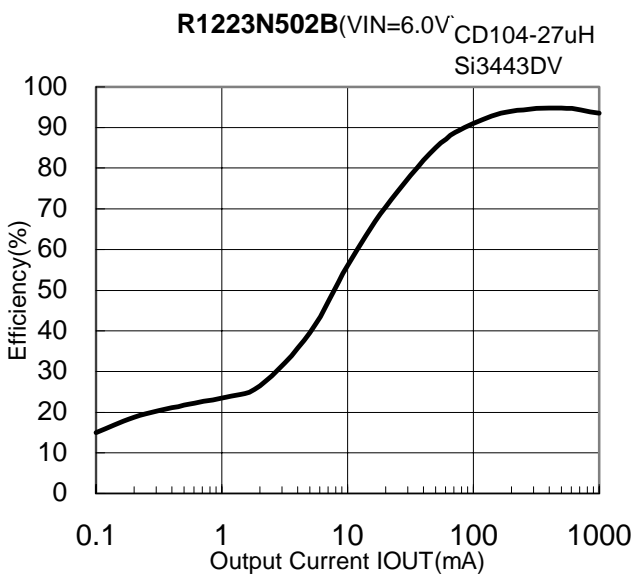
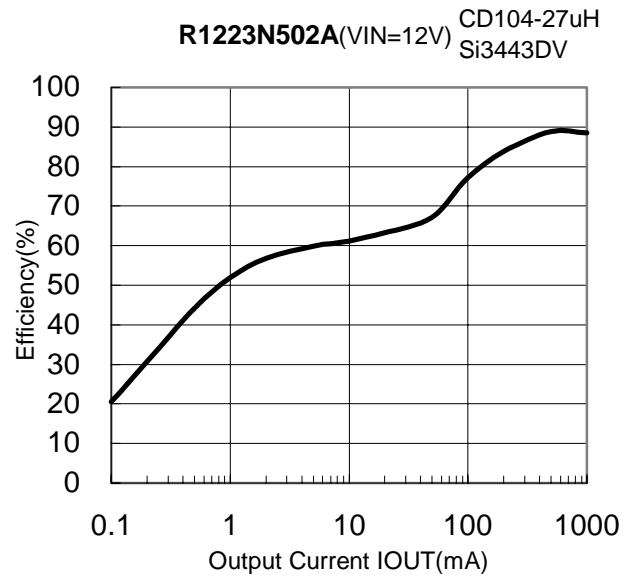
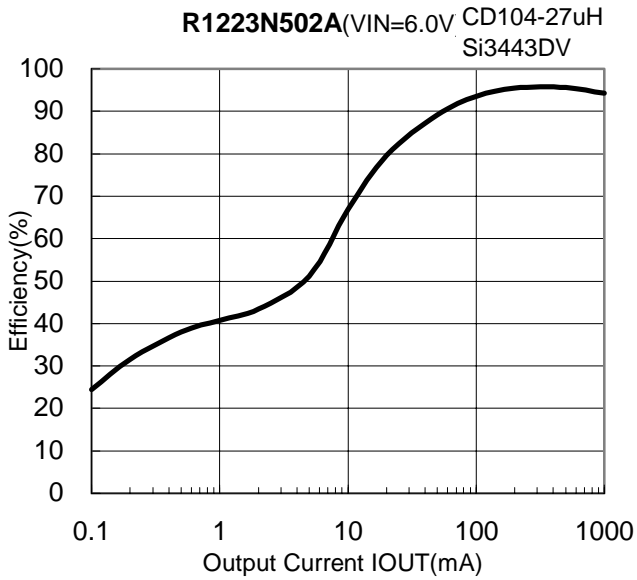
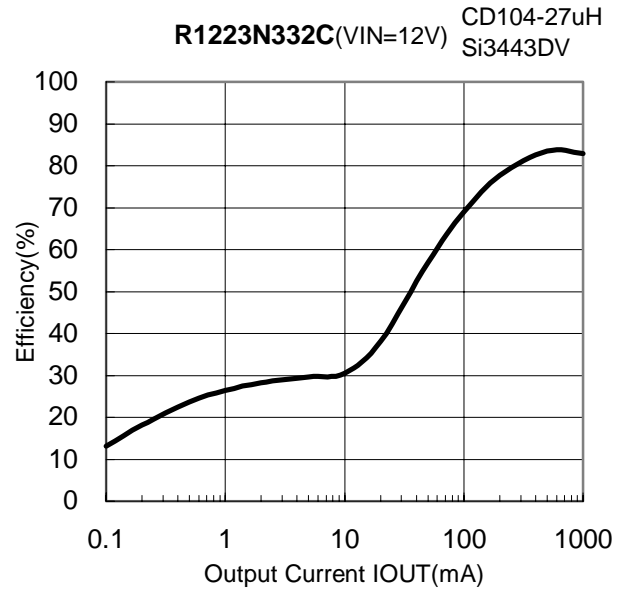
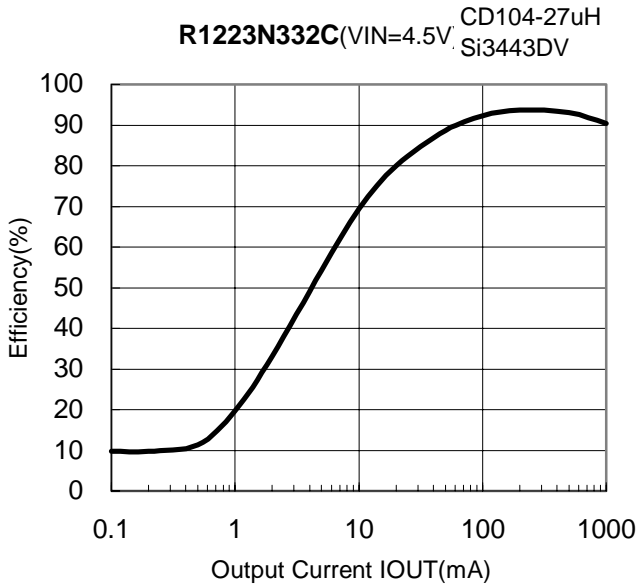

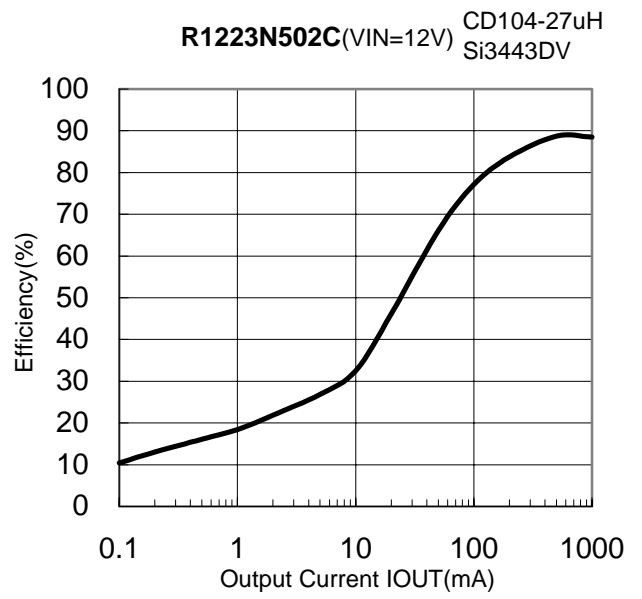
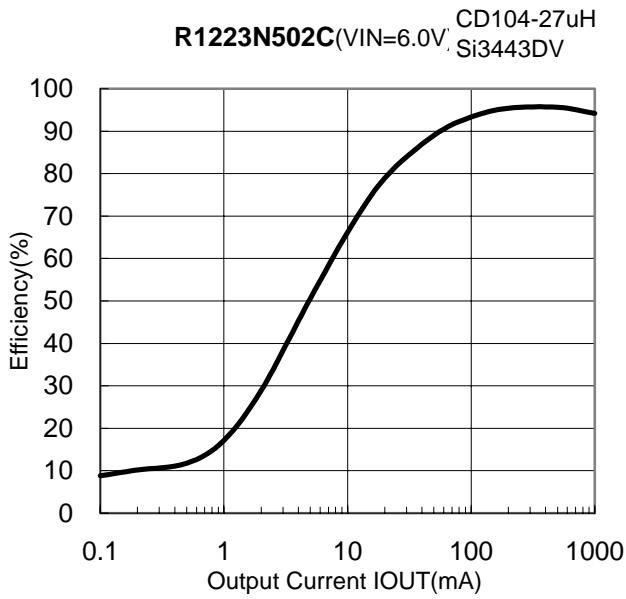

3) Ripple Voltage vs. Output Current

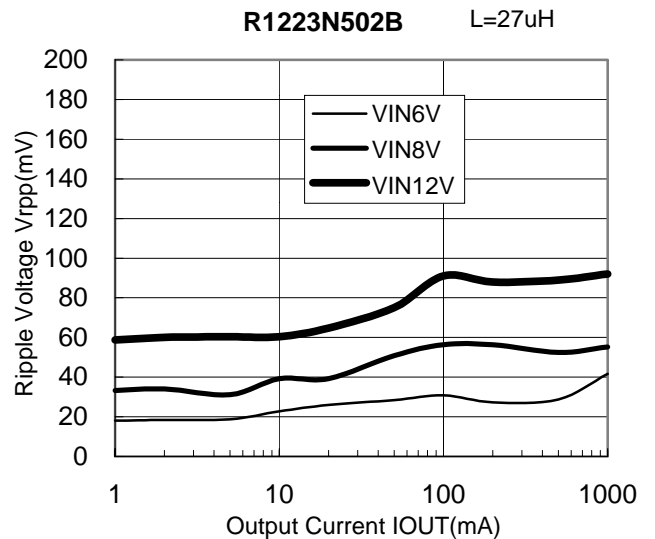
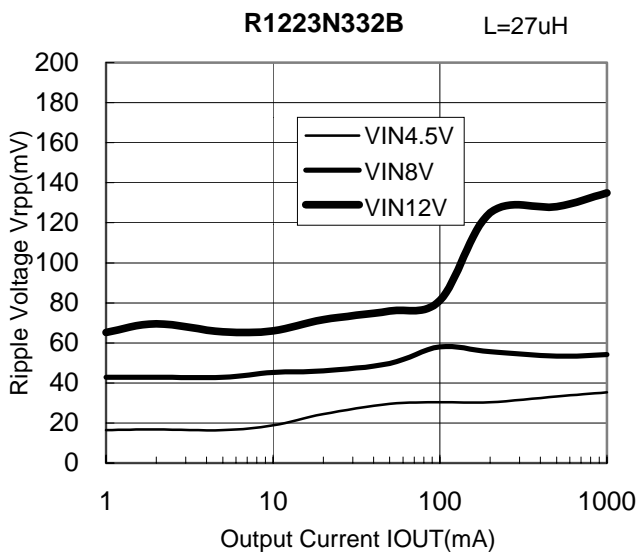
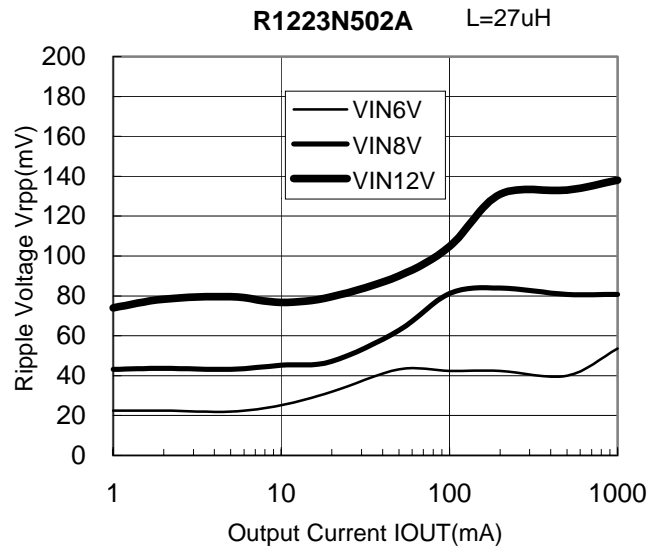
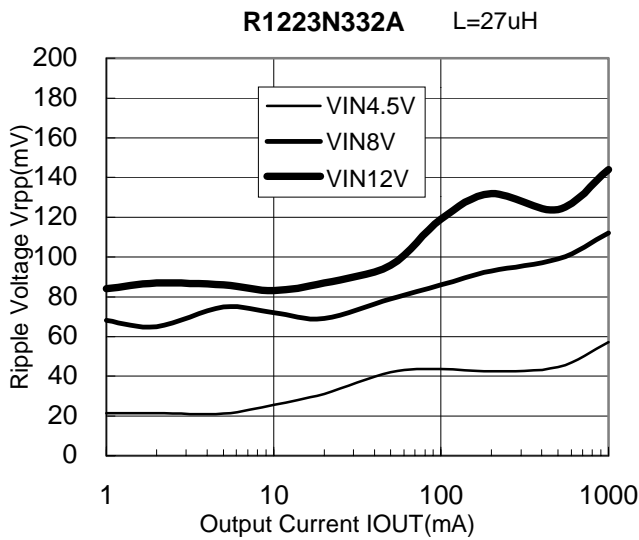

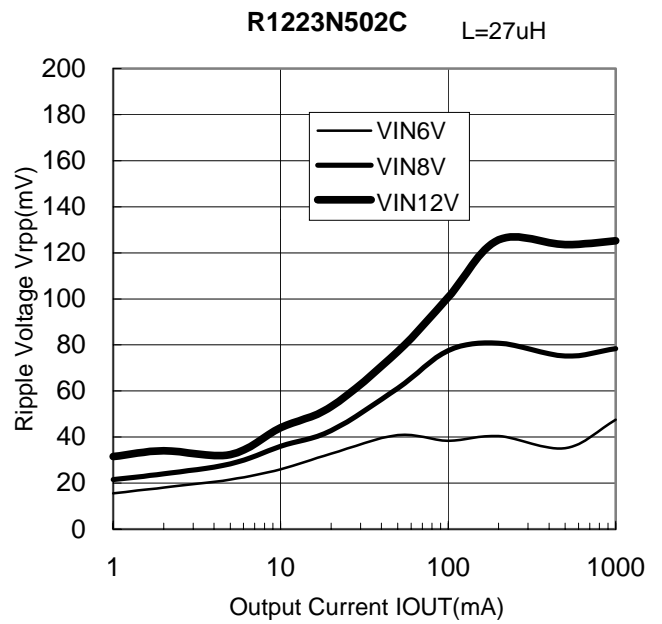
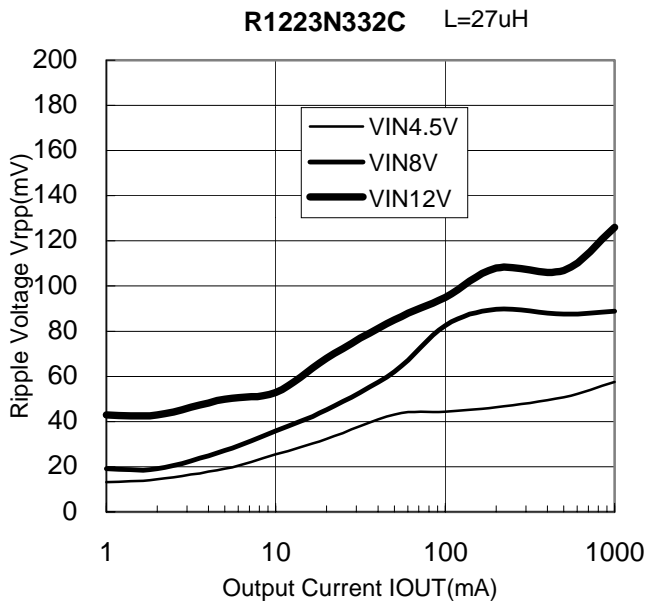

4) Oscillator Frequency vs. Input Voltage

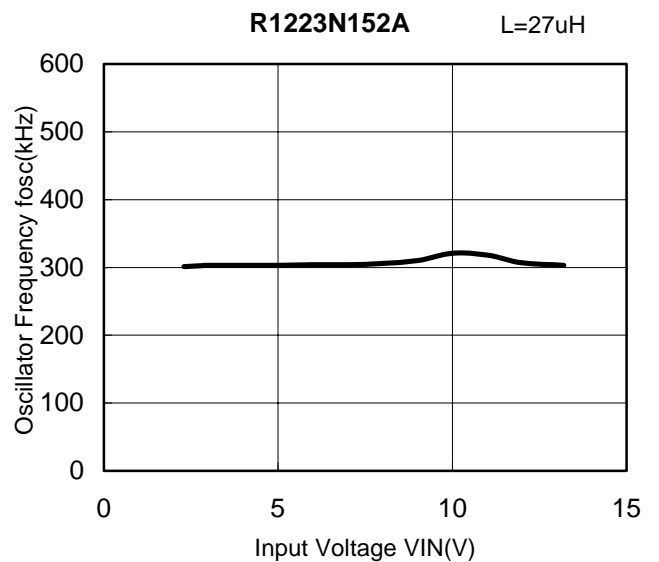
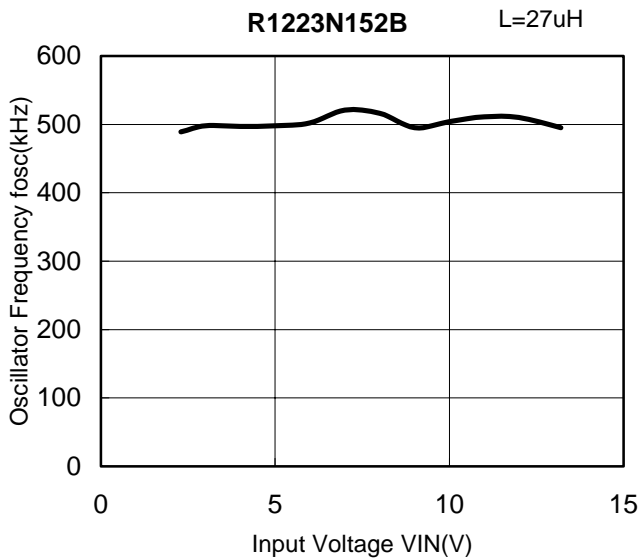

5) Output Voltage vs. Input Voltage

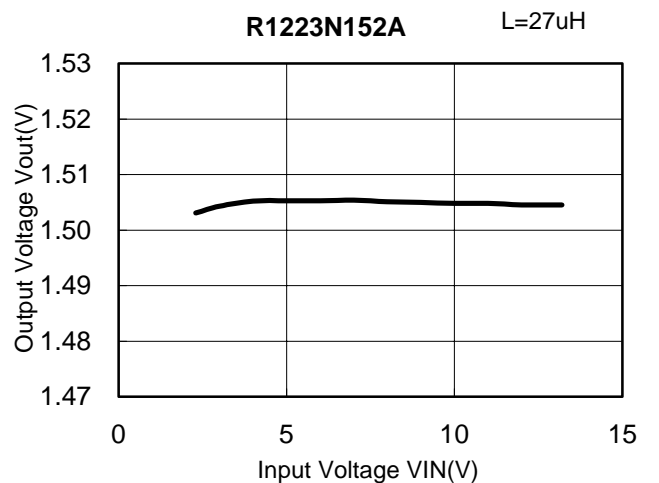
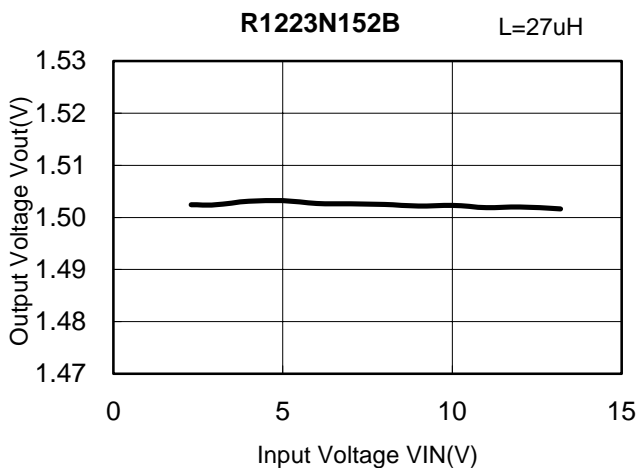

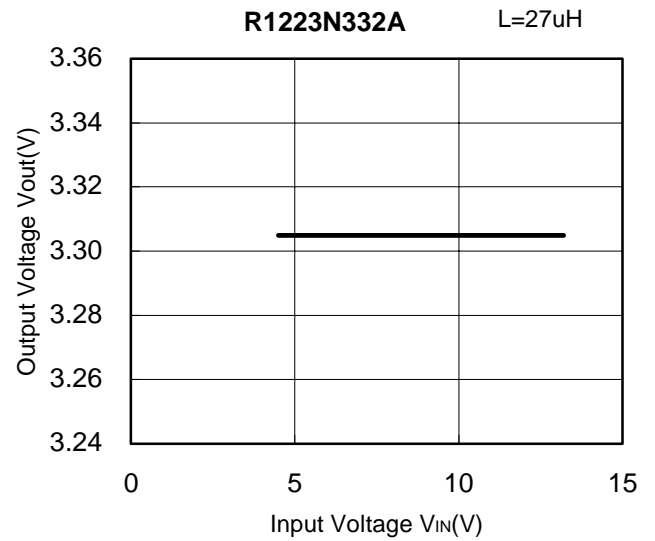
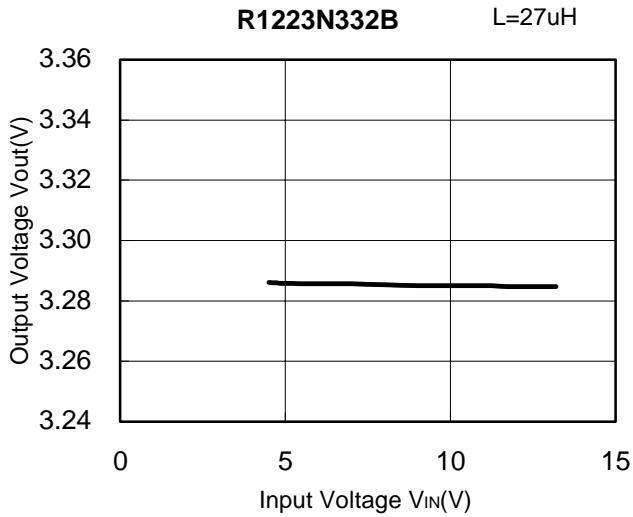

6) Output Voltage vs. Temperature

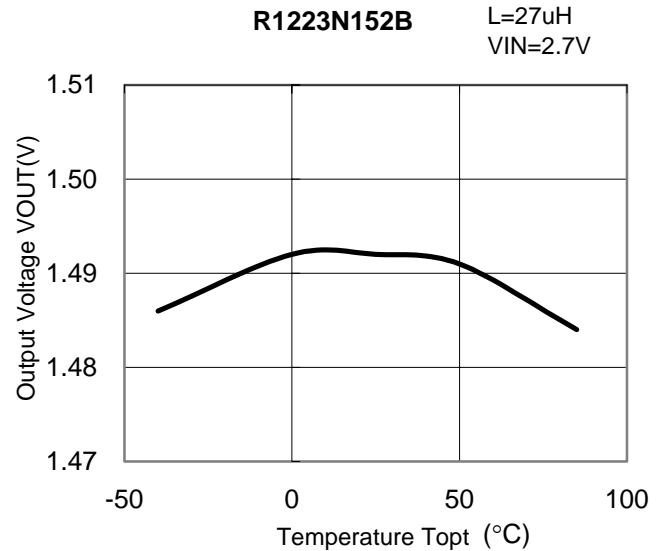
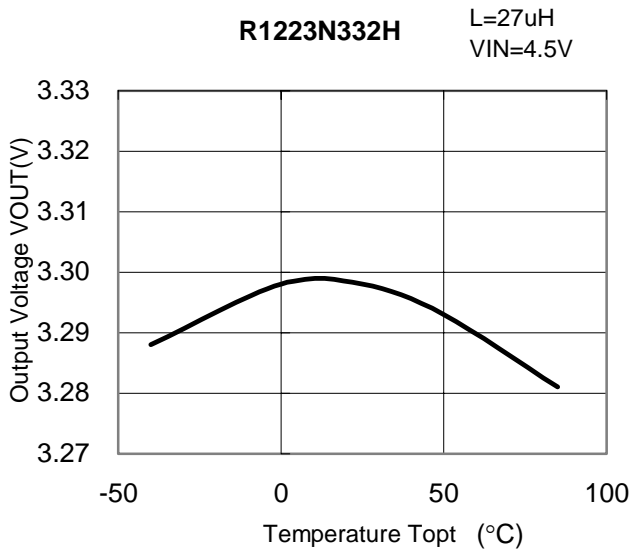

7) Oscillator Frequency vs. Temperature

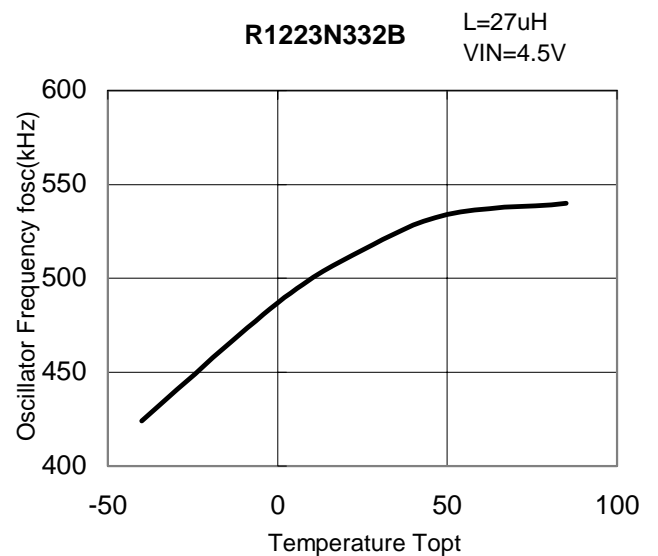
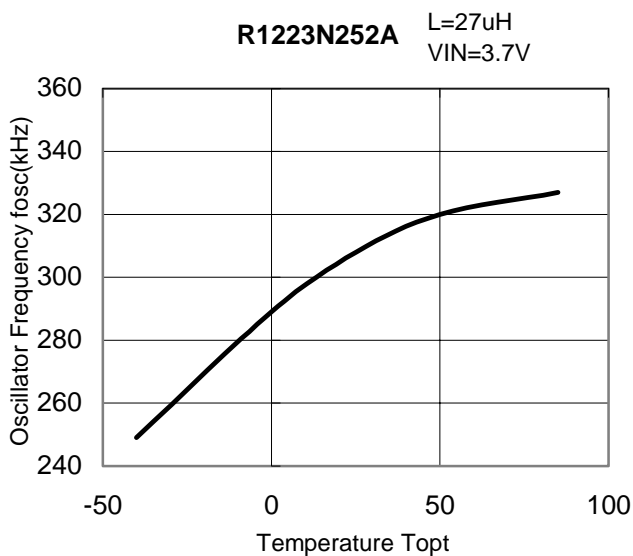

8) Supply Current vs. Temperature

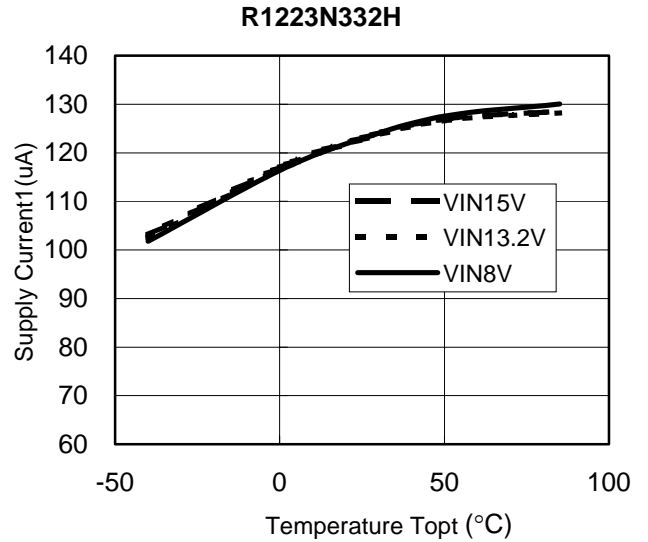
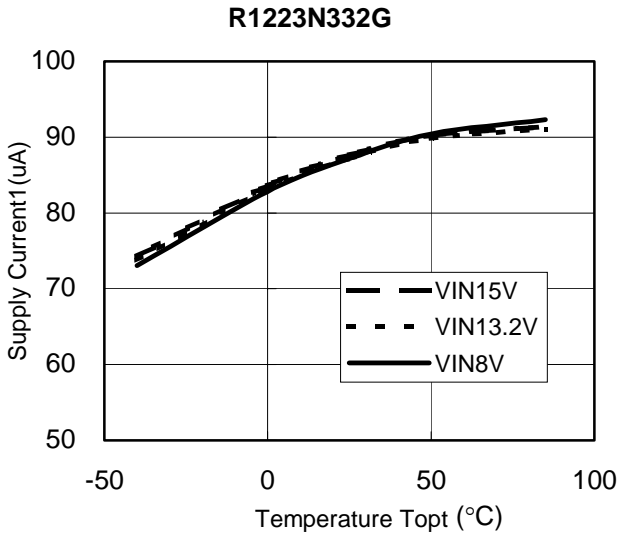

9) Soft-start time vs. Temperature

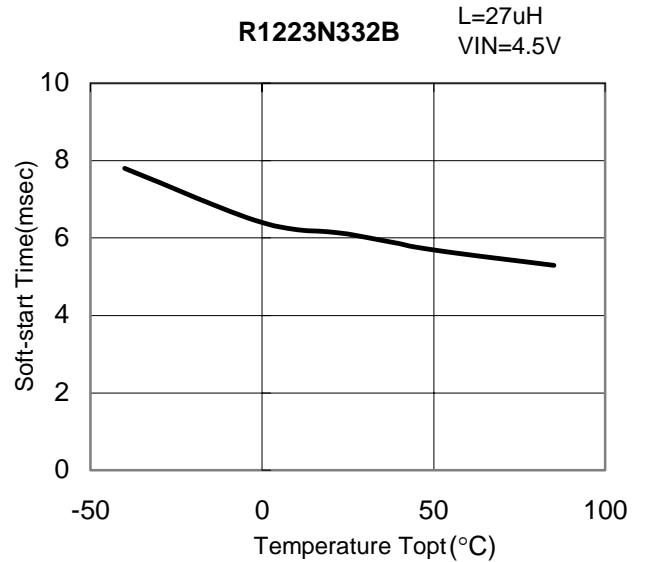
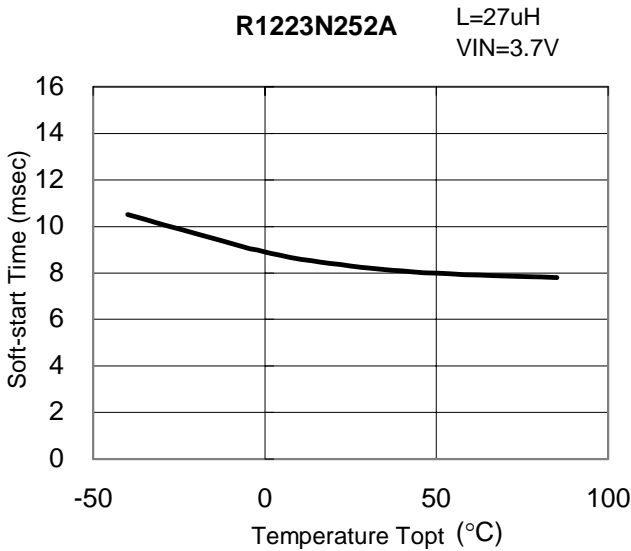

10) Delay Time for Latch-type protection vs. Temperature

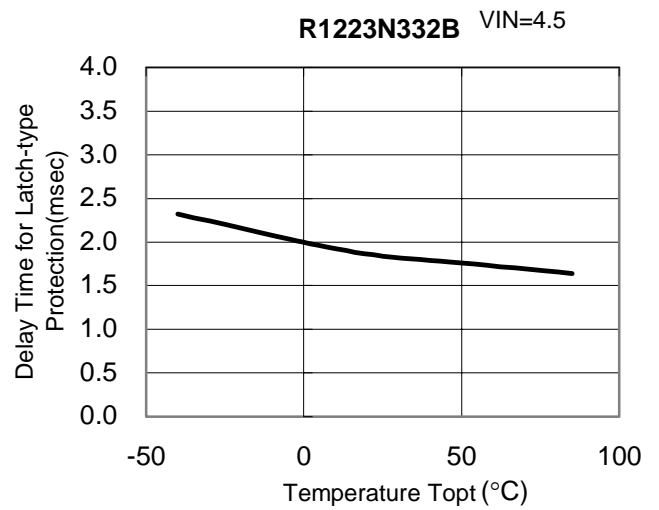
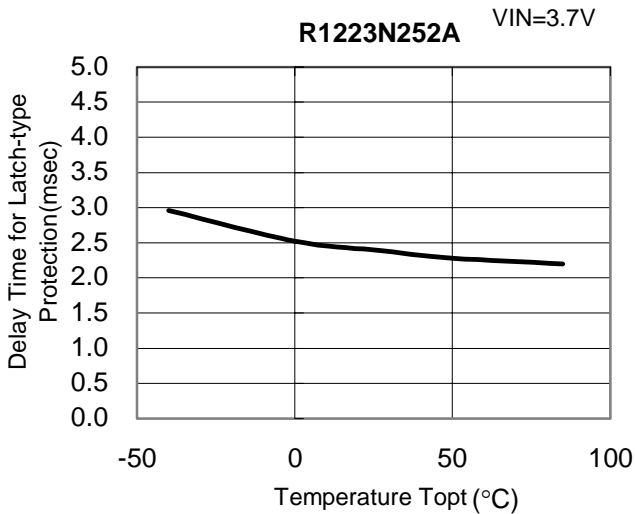

11) Delay Time for Reset-type Protection vs. Temperature

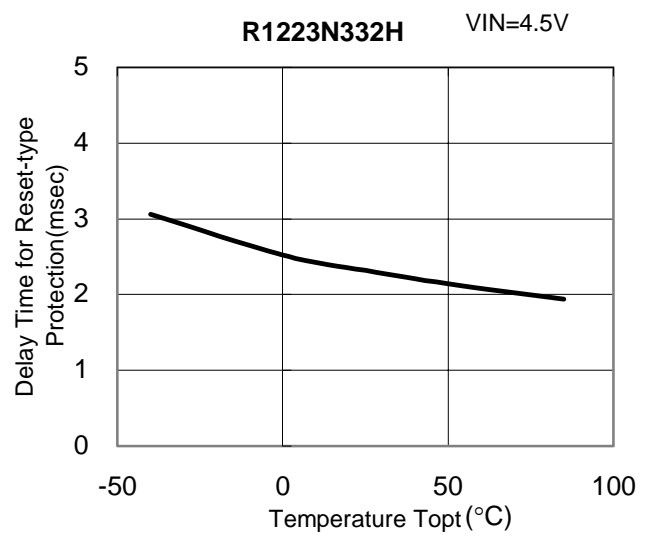
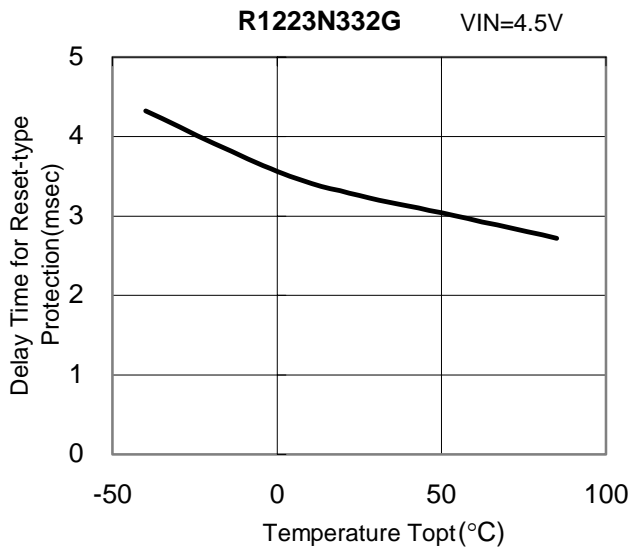

12) EXT "H" Output Current vs. Temperature

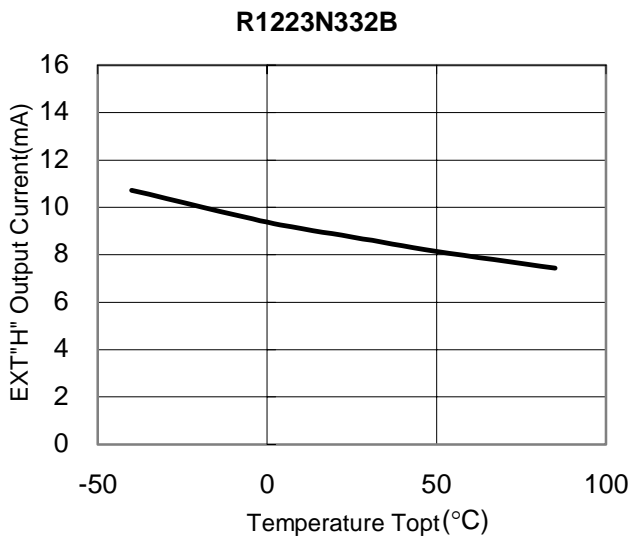

13) EXT "L" Output Current vs. Temperature

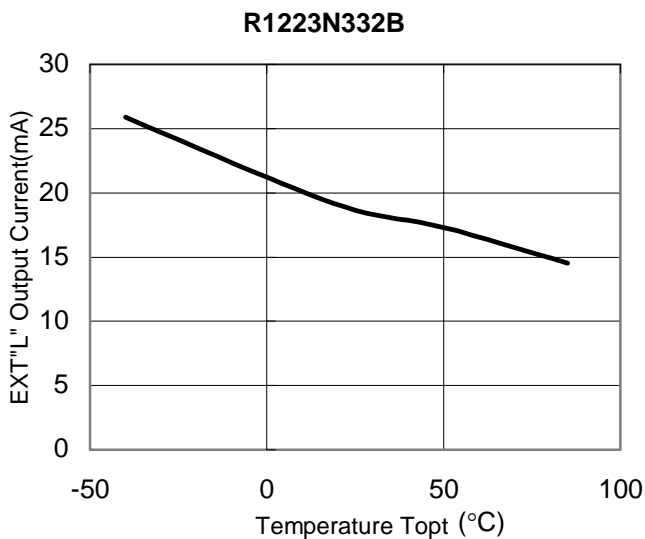

14) Load Transient Response

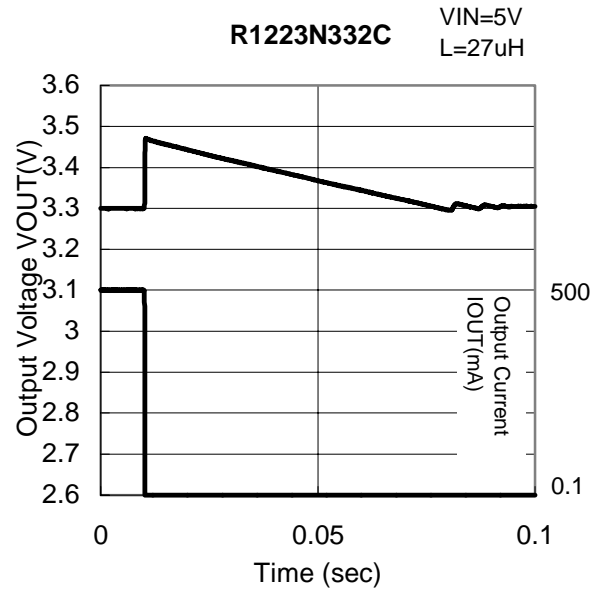
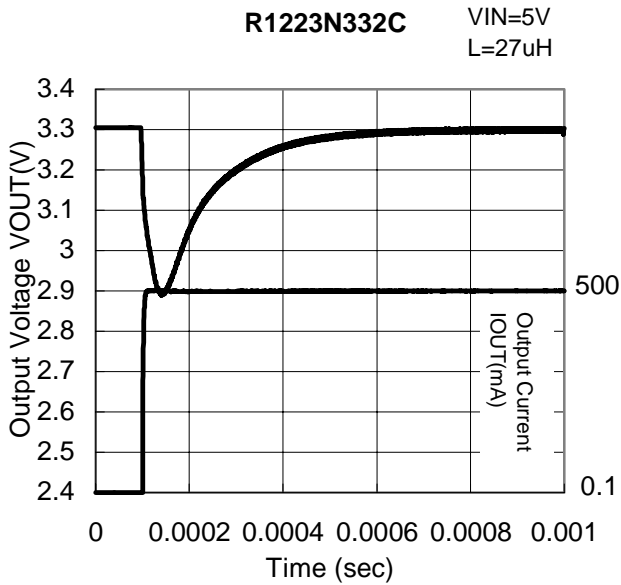
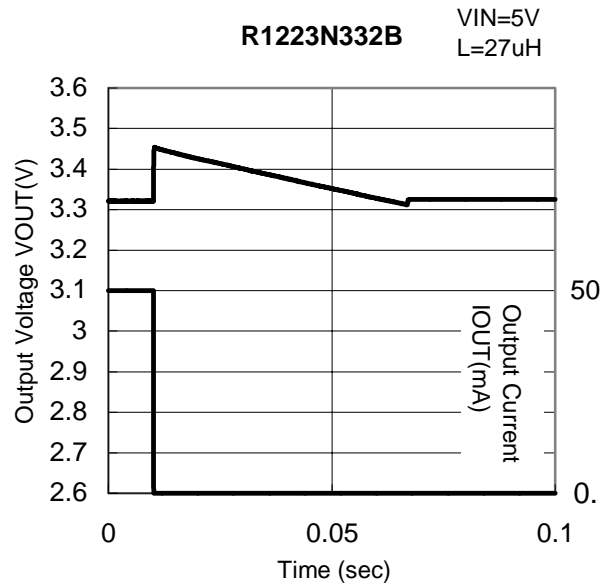
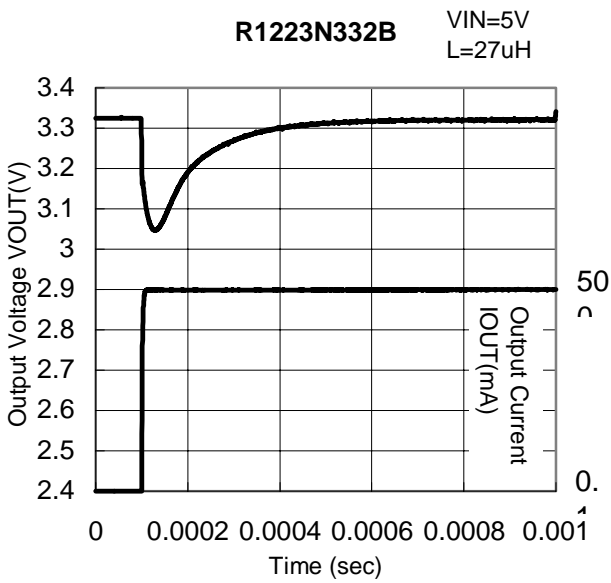
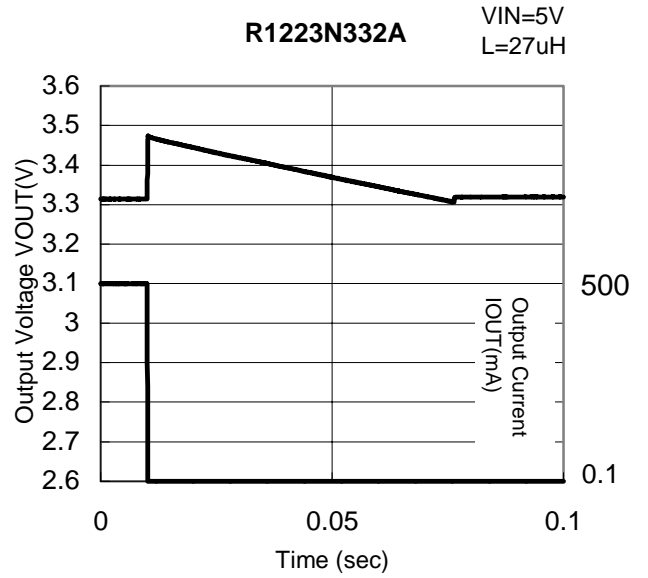
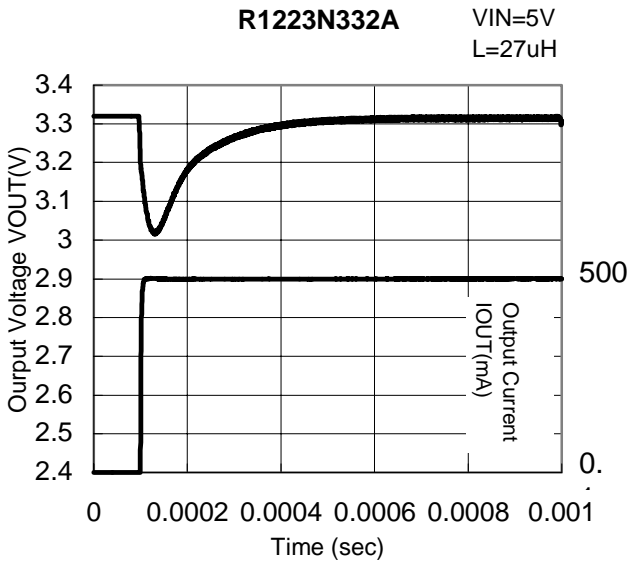

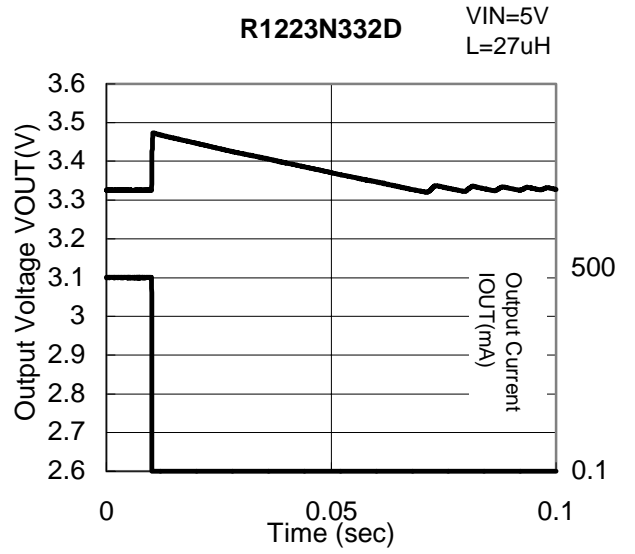
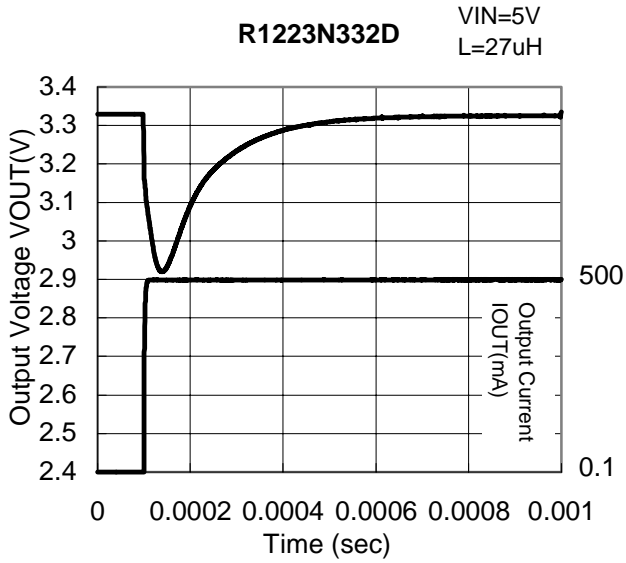

15) Turn-on Waveform

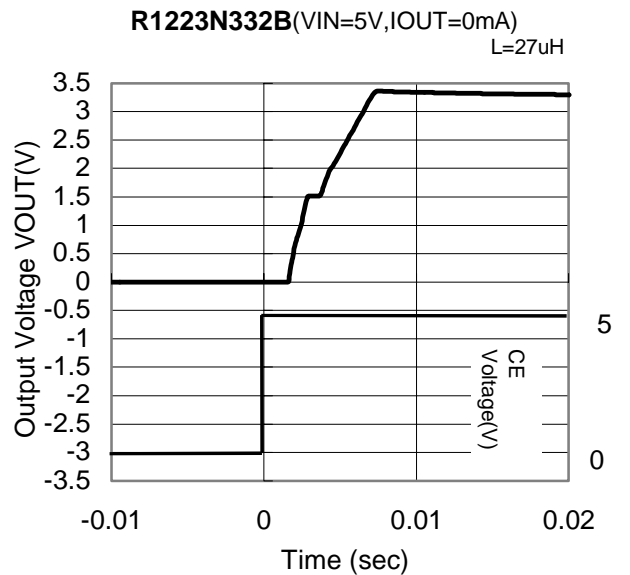
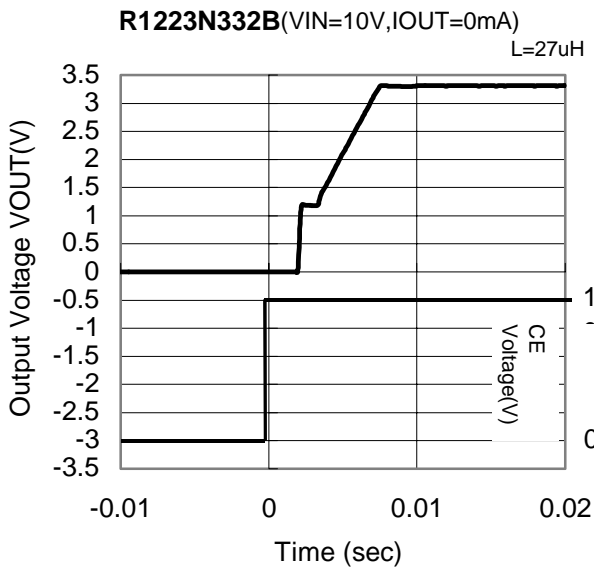
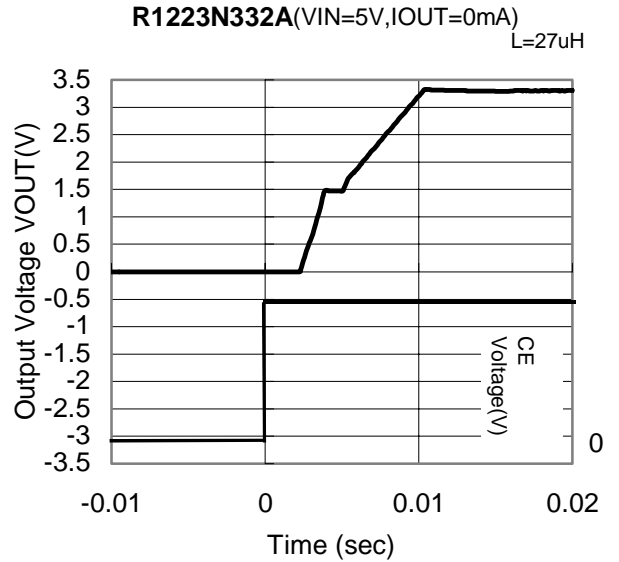
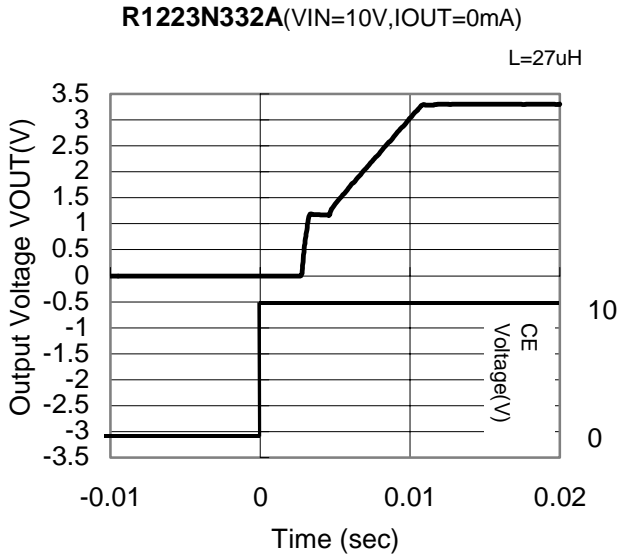

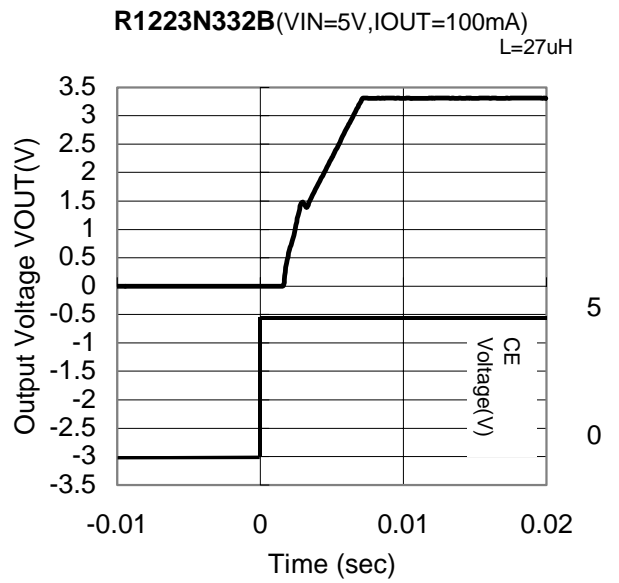
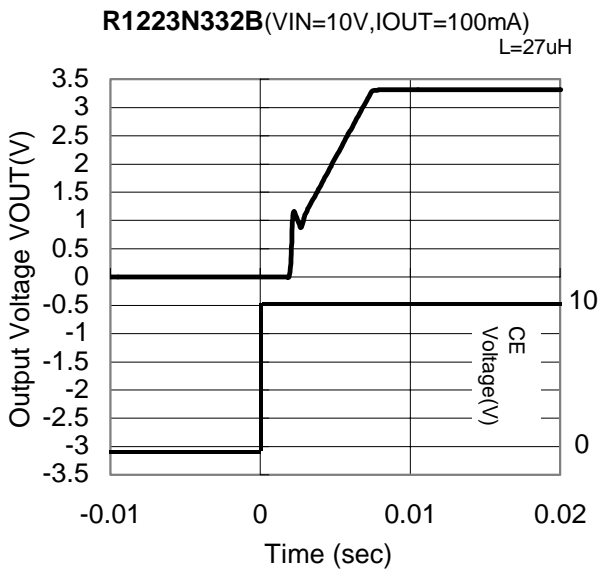
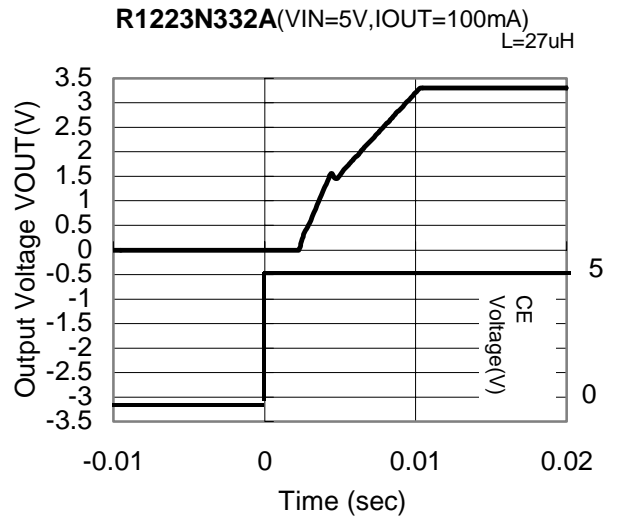
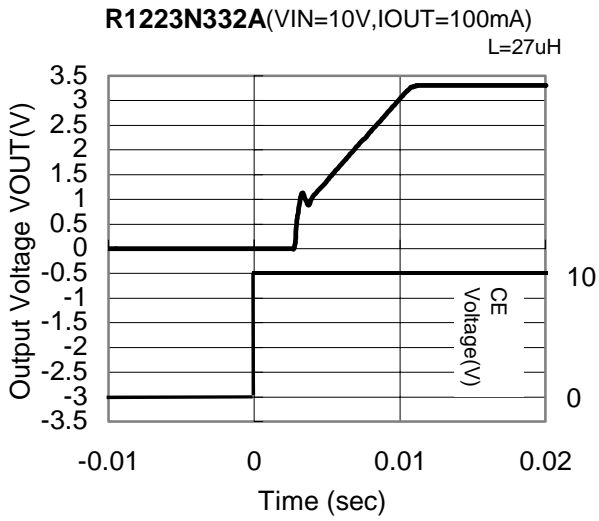



Компания «ЭлектроПласт» предлагает заключение долгосрочных отношений при поставках импортных электронных компонентов на взаимовыгодных условиях!

Наши преимущества:

- Оперативные поставки широкого спектра электронных компонентов отечественного и импортного производства напрямую от производителей и с крупнейших мировых складов;
- Поставка более 17-ти миллионов наименований электронных компонентов;
- Поставка сложных, дефицитных, либо снятых с производства позиций;
- Оперативные сроки поставки под заказ (от 5 рабочих дней);
- Экспресс доставка в любую точку России;
- Техническая поддержка проекта, помощь в подборе аналогов, поставка прототипов;
- Система менеджмента качества сертифицирована по Международному стандарту ISO 9001;
- Лицензия ФСБ на осуществление работ с использованием сведений, составляющих государственную тайну;
- Поставка специализированных компонентов (Xilinx, Altera, Analog Devices, Intersil, Interpoint, Microsemi, Aeroflex, Peregrine, Syfer, Eurofarad, Texas Instrument, Miteq, Cobham, E2V, MA-COM, Hittite, Mini-Circuits, General Dynamics и др.);

Помимо этого, одним из направлений компании «ЭлектроПласт» является направление «Источники питания». Мы предлагаем Вам помощь Конструкторского отдела:

- Подбор оптимального решения, техническое обоснование при выборе компонента;
- Подбор аналогов;
- Консультации по применению компонента;
- Поставка образцов и прототипов;
- Техническая поддержка проекта;
- Защита от снятия компонента с производства.



Как с нами связаться

Телефон: 8 (812) 309 58 32 (многоканальный)

Факс: 8 (812) 320-02-42

Электронная почта: org@eplast1.ru

Адрес: 198099, г. Санкт-Петербург, ул. Калинина, дом 2, корпус 4, литера А.