



CBI All in One DC UPS Power Solutions *Everything and more!*

- More efficiency of the battery thanks to continuous control over time.
- More monitoring in main connection nodes: input, output load, battery.
- Event logging: number of battery charging cycles, charge cycles completed, aborted charge cycles, Ah charged, charging time, total number of transitions stand-by /back-up etc.
- Event Management: checking the load output, shutdown management of PCs (UPS function), RESET management of a generic equipment.
- Flexibility of use: customization of the entire charging curve of the battery, battery type setting, setting of the various time-out algorithms of charge, setting boost voltage, absorption, float, etc... configuration as DC-UPS or batteries charger, enabling power supply function.

Power Continuity

DC-UPS = Power Supply + Battery Charger + Back Up Module

Double Output, Optimized Power Management. Thanks to the DC-UPS units, it will be possible to smart-manage available power. It will be automatically allocated between load and battery. Supplying power to the load is the first priority of the unit; thus it is not necessary to double the power, and also the power available for the battery will go to the load if the load requires so.

Output Load: 12, 24, 48
Power Boost: In x 2 Continuous
In x 3 max 4 sec.

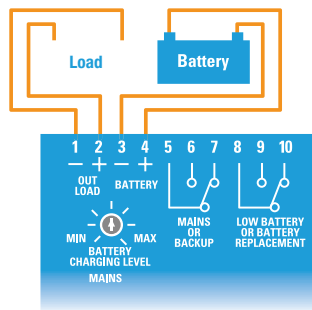

In Power Boost mode the maximum current on the load output is the 2 times the rated current (2 x In) in continuous operation and 3 times the rated current (3 x In) for max. 4 seconds.

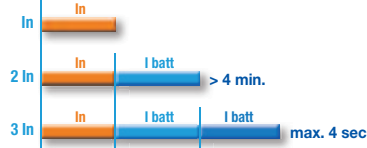

Time Buffering

Time buffering is enabled when in back-up mode. Buffering time setting is possible by operating the rotary switch on the front panel.



Smart Battery Management

Load output will not be affected by battery conditions. The DC-UPS insures continuous power supply to the load even in conditions of completely discharged batteries. The automatic multi-stage operation optimizes and adapts to the battery status. DC-UPS can recharge deeply discharged batteries even when their voltage is close to zero, thus allowing recharge and complete recovery of flat batteries.

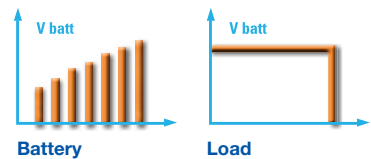

Avoid Deep Battery Discharge

In case of mains failure, the battery will supply the load until battery voltage reaches 1.5 Vpc (Volt per cell). Below this level the device automatically switches off to prevent deep discharge and battery damage.

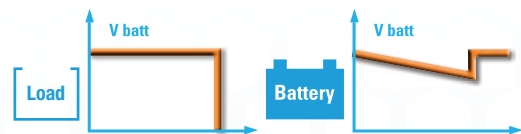

Adjustable Maximum Battery Charging Current

The maximum battery charging current can be set from 10% to 100% of the device rated value.



CBI All in One DC UPS Power Solutions



Power Continuity

Start from Battery without Main

If you want to restart the system while the mains is off, a battery restart function is available, via RTCONN cable connections, or via pushbutton in the front panel.

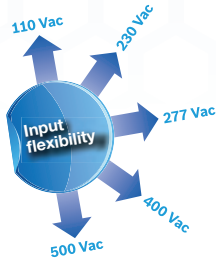
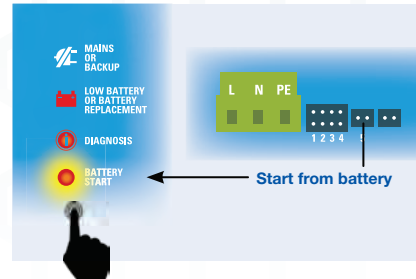

Wide input voltage range

Flexibility is given also by the wide range input voltage. The range of the devices accept input voltage 120 - 230 - 277 - 400 - 500 VAC.

One device for output 12 or 24 VDC

You can select the voltage between 12 or 24 VDC just before installing the device in your panel (available on selected products in the new Altech DC-UPS units).



Connection & Monitoring

Monitor Signals

Clear definition of each system operation, via LED indications and Relay contact:

Contact Port signals, galvanic insulation

- Main or back-up signaling relay with voltage-free. NO-NC output terminals.
- Battery faulty signaling relay, relay with voltage-free. NO-NC output terminals.
- Flat battery signaling relay, relay with voltage-free. NO-NC output terminals.

Display Signals by LED

- Input Main On Off
- Battery Fault
- Low battery (capacity less than 30%)
- Type of Battery charge mode
- Help through "blinking code" the diagnosis of the system

Driver Contact

Remote link for selection of trickle/ boost charging Via RTCONN remote connections cable it is possible to drive the devices from Boost - Bulk to Trickle - Float charge. It is also possible to permanently install a jumper for Boost - Bulk Charging.

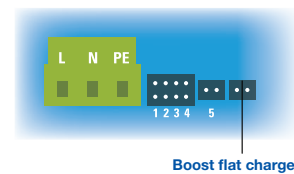
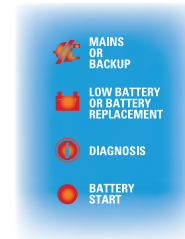
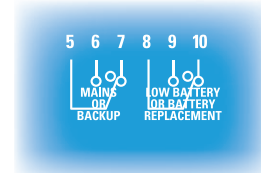

Accessories

All DC-UPS units can be made available with the following options by RJ45 or RJ11 connector:

Temperature sensor Probe, for ambient temperature compensation charging.



Voltage drop cable compensation.



Battery Start UP cable.



Auxiliary output "Aux 2 and "Aux 3" MODBUS and CANBUS

MODBUS and CANBUS connection for Multimedia management, for connection to external displays and perform customized data monitoring. Connection to:

- Power View App
- Power View System
- Power Bus
- Power View Graphic
- Power View Bar Graph
- Power View Config

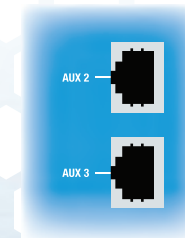

PSC Class 2 Series
Compact Housing

PSA Flex Series
1 Phase

PSB Flex Series
2 & 3 Phase

PS-S Slim Series
Plastic Housing

PS Low Profile Series
Plastic Housing

PS Industrial Series
1, 2 & 3 Phase

PS C & W Series
1 and 2 Phase

CBI Type
DC UPS Systems

CB Type
Battery Chargers

Accessories

Appendix

CBI All in One DC UPS Power Solutions

These devices are completely automatic and can charge any kind of battery using factory pre-set charging curves suitable to the most common battery technologies: open lead acid, sealed lead acid, lead gel, Ni-Cd and Ni-MH. These devices are very flexible and can be customized to meet the needs of the user and the requirements of the application. After the installation, it is possible to carry out functional software updates just using any laptop computer. Doing so, your system can always be updated to changing requirements. The Battery Care concept is based on algorithms that implement rapid and automatic charging, battery charge optimization during time, flat batteries recovery and real time diagnostic during installation and operation. Battery faults such as battery sulfated, elements in short circuit, accidental reverse polarity connection can easily be detected, identified and removed. The All in one Series meet the highest standards of quality and insure high reliability, with MTBF values up to 300.000 hours.

Battery Care

One Device for All Battery Types

All devices are suitable to charge most batteries types thank to user selectable charging curves. They can charge open lead acid, sealed lead acid, Gel, Ni-Cd, Ni-MH, Li Ion batteries. It is possible to change or add other charging curves connecting the device to a portable PC. Charging mode is then completely automatic.

 **Open Lead Acid (factory preset):**
Trickle 2.23 V
Boost 2.40 V

 **Sealed Lead Acid (1):**
Trickle 2.25 V
Boost 2.40 V

 **AGM Sealed Lead Acid (2):**
Trickle 2.27 V
Boost 2.40 V

 **Gel:**
Trickle 2.30 V
Boost 2.40 V

Optional: Ni/Cd, Li-Ion

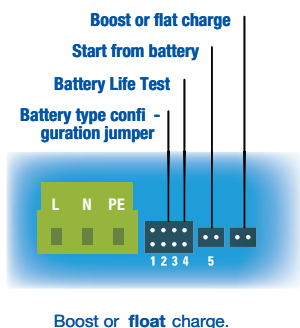

Multi-Stage Charging / Four Charging Modes

Automatic multi-stage operation and real time diagnostic allows fast recharge and recovery of deeply discharged batteries, adding value and reliability to the system hosting the DC-UPS device. The type of charging is Voltages stabilized and Current stabilized IUoU. CBI battery chargers feature four charging modes, identified by a flashing code on a LED.

- Recovery (5 Blinks / sec) able to recharge batteries even when their voltage is close to zero.
- Boost - Bulk (2 Blinks / sec).
- Absorption (1 Blinks / sec).
- Trickle - Float (1 Blink / 2 sec).

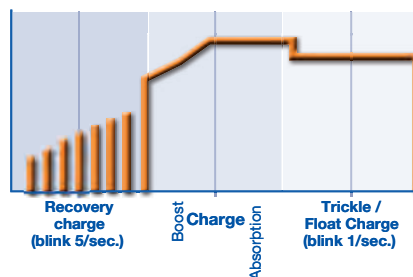

Diagnosis of Battery and Device

All CBI devices support the user during installation and operation. A LED flashing sequence code allows to discriminate among various possible faults. Error conditions, LED Fault ON and LED Diagnosis flashing with sequence of:

- 1 flash = Reverse polarity, wrong battery voltage
- 2 flashes = Disconnected battery
- 3 flashes = Battery element in short circuit
- 4 flashes = Overload
- 5 flashes = Battery to be replaced (Internal impedance Bad or Bad battery wire connection).



CBI All in One DC UPS Power Solutions

Altech Corp.

Battery Care

Battery Life Test

It guarantees battery reliability in time by continuously testing the internal impedance status. It avoids any possible risk of damages and grants also a permanent, reliable and safe connection of the battery to the power supply. The system, through a battery stimulation circuit with algorithms of evaluation of the detected parameter, is able to recognize sulfated batteries or batteries with a short-circuited cell.



Temperature Compensation

In special application like fire fighting equipment, you can recharge the battery also with the temperature compensation charging function, for the best condition of your battery in the temperature fluctuation. Use Port# CBI-RJTEMP for this application.



Diagnostic Checks

Check for accidental disconnection of the battery cables.

DC-UPS detects accidental disconnection and immediately switches off output power.

Battery not connected.

If the battery is not connected the battery output is disabled.

Test of wire connection impedance.

During trickle charge the resistance on the battery connection is checked every 20 sec. This to detect if the cable connection has been properly made.

Battery in open circuit or sulfated.

Every four hours DC-UPS tests of internal impedance, while in trickle charging mode.

Reverse polarity check.

If the battery it is connected with inverted polarity, DC-UPS is automatically protected.

Test of battery voltage connections.

Appropriate voltage check, to prevent connection of wrong battery types.

End of charge check.

When the battery it is completely full, the device automatically switches to trickle charging mode.

Check for battery cells in short circuit.

Thanks to specific testing algorithms, the DC-UPS recognize batteries with cells in internal short circuit.

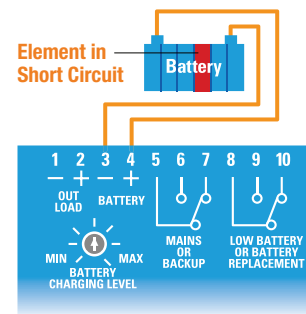

Maximum Safety and Protection

The DC-UPS series is designed to provide safe operation and long power supply and battery life. The following protections are standard features:

- Outputs protected against short circuit and overload
- Outputs in conformity to SELV and PELV conditions
- High insulation between primary and secondary
- Protection against deep battery discharge
- Protection against reverse polarity connection
- Detection of batteries with wrong rated voltage

All protections have automatic reset. No thermal fuse to be replaced. Robust construction and easy installation All the units in the range have aluminum casing, DIN rail fastening clip and are light and compact. IP20 protection degree.

Technology

The new DC-UPS range is based on two strategic know-how elements. Switching technology, we have 25 years of experience in design of advanced stabilized switching technology power supplies. A power supply/battery charger unit based on this technology is much more efficient.

Back UP Module and Battery Care units, unlike most other state-of-the-art battery chargers, the DC-UPS series is equipped with complex algorithms which controls the charging process and enable several monitoring functions. The firmware implements the extended battery care know-how, result of many years of experience in this field.

Standards:

- IEC/EN 60335-2-29 Battery chargers
- EMC Directive
- DIN 41773 (Charging cycle)
- EN60950 / UL60950
- Electrical safety EN54-4 Fire Detection and fire alarm systems

PSC Class 2 Series
Compact Housing

PSA Flex Series
1 Phase

PSB Flex Series
2 & 3 Phase

PS-S Slim Series
Plastic Housing

PS Low Profile Series
Plastic Housing

PS Industrial Series
1, 2 & 3 Phase

PS C & W Series
1 and 2 Phase

CBI Type
DC UPS Systems

CB Type
Battery Chargers

Accessories

Appendix

CBI All in One DC UPS Power Solutions



CBI All In One UPS Power Solutions combine the requirements for several applications in just one device which can be used as power supply unit, battery charger, battery care module or backup module. The available power is automatically distributed among load and battery, while supplying power to the load always is the first priority. The maximum available current of the load output is two times the value of the device's rated current.

If the device is disconnected from the main power source, the battery will supply the load until the battery voltage reaches 1.5 V per cell. This prevents the battery from deep discharge. CBI devices provide microprocessor controlled battery charging. Using algorithms, the battery's condition will be detected and based on that, an appropriate charging mode is chosen. The real-time diagnostics system will continuously monitor the charging progress and indicate possibly occurring faults such as elements in short circuit, accidental reverse polarity connection or disconnection of the battery by the battery fault LED and a flashing code of the diagnosis LED.

CBI All In One UPS Power Solutions are suitable for open/sealed lead acid-, lead gel- and optionally Ni-Cd batteries. By using the battery-select-jumper, it is possible to set predefined charging curves for those battery types. The available charging options are recovery-, boost- and trickle charge. All CB devices are built in a rugged metal case with a DIN rail mounting bracket.

Features:

- Power supply, battery charger, battery care module and backup module in one device
- Three charging modes
- Compact, rugged metal case
- Available in 12VDC, 24VDC and 48VDC
- Suitable for most common battery types
- Adjustable charging current
- Easy battery diagnosis and fault identification either by LED or external devices connected to fault
- Status contacts
- High efficiency up to 91% through switching technology
- Several output protection features such as short circuit, overload, deep battery discharge etc.
- DIN rail mounting
- Small size
- 3 year warranty



Battery Selection Chart

| Battery type | 1.2 Ah | 3.2 Ah | 7.2 Ah | 12 Ah |
|--------------|--------|--------|--------|-------|
| Load 1.5 A | 20 | 60 | 200 | 400 |
| Load 3 A | 8 | 30 | 120 | 240 |
| Load 5 A | 3 | 15 | 55 | 100 |
| Load 7.5 A | 2 | 10 | 30 | 60 |
| Load 10 A | - | 7 | 20 | 45 |
| Load 12 A | - | 3 | 12 | 30 |
| Load 15 A | - | - | 9 | 20 |
| Load 20 A | - | - | 7 | 13 |

For the latest on Altech Power Supply specifications please visit www.altechcorp.com/power.

CBI All in One DC UPS Power Solutions

The new communication platform for ALTECH CORP. devices allows the connection of all components in a simple but very powerful way. A single communication protocol based on MODbus-RTU or CANbus technology. You can select any of the two buses depending on the application. It allows to communicate with all the accessories provided by ALTECH CORP. and to develop an independent system for electrical continuity. At the same time, it allows monitoring and control all parameters in the system, even from the other side of the world, by means of application tools on the cloud.

ALTECH CORP. allows you to implement very simple but sophisticated monitoring and control for your energy system and opens your mind to new ways to approach your applications.

1 Power View App

System Monitoring Software APP for Tablet "Power View App", is an application for tablet, available in free download. With this App it is possible to connect to ALTECH CORP. cloud and visualize in real time data stored in your own account on the cloud. Data upload is possible through "Power Bus", an ALTECH CORP. MODBUS/Ethernet interface which connects the DC-UPS MODBUS output to the cloud. Uploaded data can be battery voltage, charge current, discharge current, level of charge, charging mode, alarms, diagnostic signals and more. This allows monitoring of DC-UPS and battery status from any location. It just requires wireless internet connection via tablet.

2 Power View System

Monitoring Software "Power View System" is a PC-based software developed to monitor in real time every important parameter of the DCUPS/battery system. A simple and intuitive user's interface allows monitoring of battery parameters, load output, temperature sensor, mains presence and all alarm and diagnostic flags. All feature are displayed in a single screen.

3 Power View Graphic

Multifunction Graphic Display "Power View Graphic" is a Multifunction Graphic Display that can be connected by a single data/power cables to the MODBUS interface of a DC-UPS. It allows to display all parameters of the DC-UPS/battery system that can be accessed by moving through the various screens with a push button user's interface. The screen is back-lit and features a screen saver function for energy saving and longer life.

4 Power View Bar Graph

"Power View Bar Graph" is a circular LED display device for panel mount. Simple and sturdy, it displays the current charge mode, state of charge and system diagnostics at a glance.

5 Power Bus

Interface Module MODBUS 485 - Ethernet and Cloud ALTECH CORP. provides a set of educated MODBUS interfaces that allow remote access to DC-UPS/battery data. Both Ethernet and Cloud communication is therefore made feasible.

6 Power Storage Devices

No matter how large or small the capacity of the battery storage needed in the system, ALTECH CORP. DC-UPS devices allow simple and effective integration. ALTECH CORP. has been a pioneer in the development of automatic charging and monitoring DC-UPS. Thanks to Adel Battery Care technology every battery will be taken care of and will last longer. Continuous system monitoring and life test checking allows preventive replacement and therefore increased system reliability. For a compact and optimized integration, ALTECH CORP. supplies Batt VRLA battery modules.

7 Temperature Compensated Charging

By installing the battery temperature probe "RJ Temp", the charge voltage is automatically adapted to battery temperatures. When the battery temperature is low, the charge voltage increases. Conversely, when battery temperature is high, charge voltage is decreased. Over charge and gassing are thus prevented. This will extend battery life, the specific goal of Adel Battery Care philosophy.

8 Load

The DC-UPS unit mission is to always keep the load supplied. The Load Output is the source of power for the whole electric system and has been designed to perform this duty under the most critical conditions, no matter if during stand-by or back-up modes.

9 Inverter

Among the loads there are sometime devices which requires AC power. In this case an inverter must be installed. ALTECH CORP. DC-UPSs allow connection of inverters up to 1500W.

10 Power View Config

System Configuration Software "Power View Config" is a PC-based software with simple and effective user interface that allows application engineer to configure the system, customize battery charging curve, set alarm thresholds, configure the parameters available for communication on the MODBUS output. Output Voltage: 12, 24, 48 Vdc.

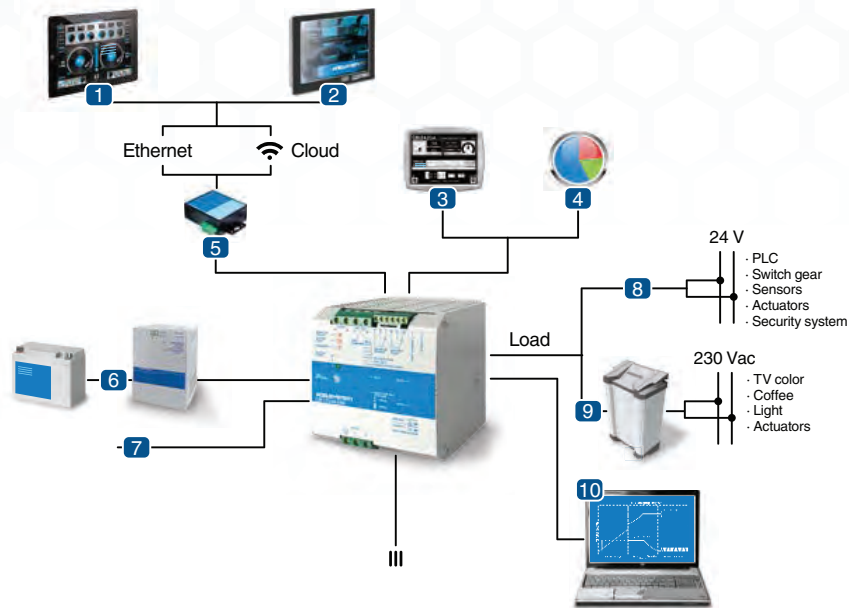

PSC Class 2 Series
Compact Housing

PSA Flex Series
1 Phase

PSB Flex Series
2 & 3 Phase

PS-S Slim Series
Plastic Housing

PS Low Profile Series
Plastic Housing

PS Industrial Series
1, 2 & 3 Phase

PS C & W Series
1 and 2 Phase

CBI Type
DC UPS Systems

CB Type
Battery Chargers

Accessories

Appendix

CBI All In One UPS Power Solutions Specifications



Features:

- Power supply, battery charger, battery care module and backup module in one device
- Three charging modes
- Several output protection modes
- Compact, rugged metal case
- Available in 12VDC, 24VDC and 48VDC
- Suitable for most common battery types
- Three charging modes
- Adjustable charging current
- High efficiency up to 91% through switching technology
- DIN rail mounting
- Small size
- 3 year warranty

* Case Sizes

Size 1: 65 mm x 115 mm x 135 mm

Size 2: 100 mm x 115 mm x 135 mm

Size 3: 150 mm x 115 mm x 135 mm

Case 1



12V DC Single Phase DIN Rail All In One UPS Power Solution

| Cat. No. | Case* | Input VAC | Output* VDC | | Recovery Charge VDC | Trickle Charge VDC | Boost Charge VDC | NOTES |
|----------|-------|-------------|-------------|----|---------------------|--------------------|------------------|-------|
| | | | A | A | | | | |
| CBI123A | 1 | 115-230-277 | 12 | 3 | 2-9 | 13.75 | 14.4 | |
| CBI126A | 1 | 115-230-277 | 12 | 6 | 2-9 | 13.75 | 14.4 | |
| CBI1210A | 1 | 115-230-277 | 12 | 10 | 2-9 | 13.75 | 14.4 | |
| CBI1235A | 3 | 115-230-277 | 12 | 35 | 2-9 | 13.75 | 14.4 | |

Case 2



24V DC Single Phase DIN Rail All In One UPS Power Solution

| Cat. No. | Case* | Input VAC | Output* VDC | | Recovery Charge VDC | Trickle Charge VDC | Boost Charge VDC | NOTES |
|----------|-------|-------------|-------------|----|---------------------|--------------------|------------------|-------|
| | | | A | A | | | | |
| CBI243A | 1 | 115-230-277 | 24 | 3 | 2-16 | 27.5 | 28.8 | |
| CBI245A | 1 | 115-230-277 | 24 | 5 | 2-18 | 27.5 | 28.8 | |
| CBI2410A | 2 | 115-230-277 | 24 | 10 | 2-16 | 27.5 | 28.8 | |
| CBI2420A | 3 | 115-230-277 | 24 | 20 | 2-16 | 27.5 | 28.8 | |

Case 3



48V DC Single Phase DIN Rail All-In-One UPS Power Solution

| Cat. No. | Case* | Input VAC | Output* VDC | | Recovery Charge VDC | Trickle Charge VDC | Boost Charge VDC | NOTES |
|----------|-------|-------------|-------------|----|---------------------|--------------------|------------------|-------|
| | | | A | A | | | | |
| CBI485A | 2 | 115-230-277 | 48 | 5 | 2-24 | 55 | 57.6 | |
| CBI4810A | 3 | 115-230-277 | 48 | 10 | 2-24 | 55 | 57.6 | |

Multi-Voltage DIN Rail All-In-One UPS Power Solution

| Cat. No. | Case* | Input VAC | Output* VDC | | Recovery Charge VDC | Trickle Charge VDC | Boost Charge VDC | NOTES |
|--------------|-------|-------------|-------------|--------|---------------------|--------------------|------------------|-------|
| | | | A | A | | | | |
| CBI280 3648A | 2 | 115-230-277 | 36/ 48 | 7/ 5 | 2-24 | 41/ 55 | 43.2/ 57.6 | |
| CBI280 1224A | 2 | 115-230-277 | 12/ 24 | 15/ 10 | 2-18 | 13.75/ 27.5 | 14.4/ 28.8 | |
| CBI280 1224B | 2 | 230-400-500 | 12/ 24 | 15/ 10 | 2-16 | 13.75/ 27.5 | 14.4/ 28.8 | |

*= Output Current can be adjusted from 20%-100% of value given above

For the latest on Altech Power Supply specifications please visit www.altechcorp.com/power.

SPECIFICATIONS

Case 1

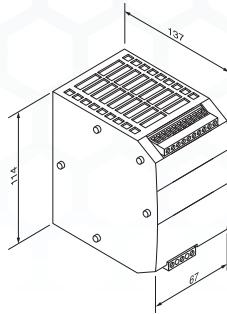

Input Voltage: 115 - 230 - 277 VAC
Input Current: 2.8-1.3A (115-230VAC)
Connection: screw terminal blocks for wires 0.2-2.5mm² / AWG 24-14
Size (WxHxD): 65x115x135 mm
Packaging: 0.6kg

Jumper for Battery Type Selection

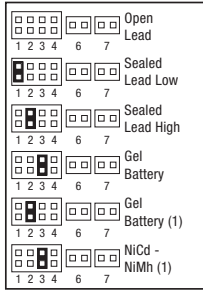

Jumper for Functional Setting

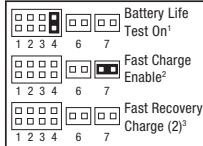

¹ Jumper present: life test enabled.
² Jumper present: fast test enabled.
³ Jumper present: fast recovery charge enabled only for size 3. Possibility to recharge the battery also when the voltage is close to zero with the maximum power of the device.

Case 2



Input Voltage: 115 / 230 - 277 VAC
Input Current: 3.3-2.2A (115-230VAC)
Connection: screw terminal blocks for wires 0.2-2.5mm² / AWG 24-14
Size (WxHxD): 100x115x135 mm
Packaging: 0.85kg

Jumper for Battery Type Selection



Jumper for Functional Setting

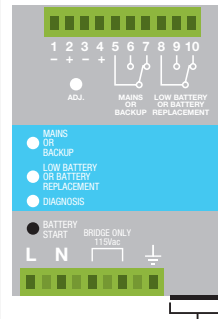

¹ Jumper present: life test enabled.
² Jumper present: fast test enabled.
³ Jumper present: fast recovery charge enabled only for size 3. Possibility to recharge the battery also when the voltage is close to zero with the maximum power of the device.

Case 3

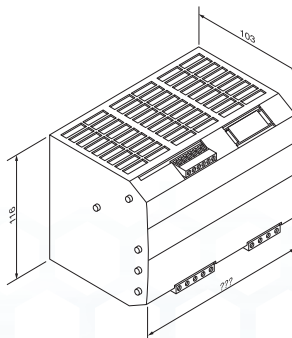

Input Voltage: 115 / 230 - 277 VAC
Input Current: 8-4.2A (115-230VAC)
Connection: screw terminal blocks for wires 4mm² / AWG 30-10
Size (WxHxD): 150x115x135 mm
Packaging: 1.55kg

Jumper for Battery Type Selection



Jumper for Functional Setting

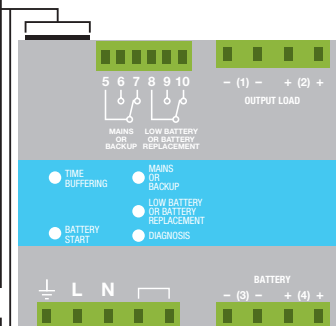

¹ Jumper present: life test enabled.
² Jumper present: fast test enabled.
³ Jumper present: fast recovery charge enabled only for size 3. Possibility to recharge the battery also when the voltage is close to zero with the maximum power of the device.

PSC Class 2 Series Compact Housing

PSA Flex Series 1 Phase

PSB Flex Series 2 & 3 Phase

PS-S Slim Series Plastic Housing

PS Low Profile Series Plastic Housing

PS Industrial Series 1, 2 & 3 Phase

PS C & W Series 1 and 2 Phase

CBI Type DC UPS Systems

CB Type Battery Chargers

Accessories

Appendix



CBI123A DC UPS



Features:

- Input: Single-phase 115 - 277 VAC
- Output Load: power supply 12 VDC; 3 A
- Output: Battery charging 12 VDC; 3 A
- Suited for the following battery types:
Open Lead Acid, Sealed Lead Acid, lead Gel and Ni-Cd (option)
- Automatic diagnostic of battery status.
- Switching technology, output voltage 10-14.4 VDC
- Three charging levels: Boost, trickle and recovery
- Protection degree IP20 - DIN rail mountable

INPUT

OUTPUT

PROTECTION

LOAD OUTPUT

BATTERY OUTPUT

OTHERS

Cat. No.

CBI123A

| | |
|---|---|
| Nominal Input Voltage | 115 ~ 230 ~ 277 VAC |
| Voltage range | 90 – 305 VAC |
| Inrush Current ($V_n - I_n$ nom. Load). I^2t | $\leq 11 A \leq 5$ msec |
| Frequency | 47 – 63 Hz |
| Input Current (115 – 230 VAC) | 2.8 ~ 1.3 A |
| Internal fuse (factory replaceable) | 4 A |
| External Fuse (recommended) MCB curve B | 10 A |
| Output Voltage (V_n) / Nominal Current (I_n) | 12 VDC / 3A |
| Output Current I_n | 3 A |
| Efficiency (at 50% of rated current) | ≥ 90 % |
| Turn-On delay after applying input voltage | 1 sec. (max) |
| Start up with Strong Load (capacitive load) | Yes, Unlimited |
| Dissipation power load max | 9 W |
| Short-circuit protection | Yes |
| Over Load protection | Yes |
| Over Voltage Output protection | Yes (typ. 35 VDC) |
| Over Temperature protection | Yes |
| Output voltage (at I_n) | 10 ~ 14.4 VDC |
| Nominal current I_{load} | $1.1 \times I_n A \pm 5\%$ |
| Continuous current (without battery) $I_{load} = I_n$ | 3 A |
| Continuous current (with battery) $I_{load} = I_n + I_{batt}$ | 6 A |
| Max. Current Output Load (Main) I_{load} (4 sec.) | 9 A max. |
| Max. Current Output Load (Back Up) I_{load} (4 sec.) | 6 A max. |
| Push Button or Remote Input Control (RTCONN cable) | Start From Battery Without Main |
| Time Buffering; min (switch output off without main input) | ∞ : standard 5 min.: Require SW |
| Protection alarm against total discharge | 9-10V DC battery |
| Threshold alarm for battery almost flat | 10-11 V DC battery |
| Boost charge (25 °C) (at I_n) | 14.4 VDC |
| Max. time Bust Charge | 15 h |
| Min. time Bust Charge | 1 min. |
| Trickle charge (25 °C) (at I_n) | 13.75 VDC |
| Jumper Configuration battery type (V cell) Ni-Cd (optional) | 2.23; 2.25; 2.27; 2.30; NiCd: 1.50 (10 elem.) |
| Recovery Charge | 2 ~ 9 VDC |
| Charging current max I_{batt} | 3 A $\pm 5\%$ |
| Charging current limiting I_{adj} | 20 – 100 % / I_{batt} |
| Reverse battery protection | Yes |
| Sulfated battery check | Yes by Jumper |
| Detection of element in short circuit | Yes |
| Quiescent Current | ≤ 5 mA |
| Charging Curve automatic: I_{UoUo} | 3 stage |
| Remote Input Control (RTCONN cable) | Boost /Trickle / Recovery |
| Ambient temperature (operation) | -25 – +70°C |
| De Rating $T_a > 50^\circ C$ | - 2.5%(In) / °C |
| Ambient temperature Storage | -40 – +85°C |
| Humidity at 25 °C no condensation | 95% |
| Cooling | Auto convection |
| MTBF | > 300.000 h (IEC 61709) |

CBI123A DC UPS

The Altech DC-UPS system is built to optimize power management. The available power is automatically allocated between load and battery, supplying power to the load is the first priority. For high inrush applications the charging power will reroute automatically to the load. In this case the maximum available current on the load output is two times the value of the device rated current.

The Battery Care concept based on algorithms that achieve rapid and automatic charging, battery optimization during charging time, flat batteries recovery and real time diagnostic. The Real Time Auto-diagnostic system, monitors battery faults, sulfated battery, short circuit battery elements, reverse polarity connection, battery disconnect. This conditions are detected and identified by the number of blinks of the diagnosis Led.

Signal Output Contacts

| | |
|--------------------------------------|------------------|
| Main or Backup Power | Yes |
| Battery Power Low | Yes |
| Battery Fault | Yes |
| Max. Current Rating (Resistive Load) | 1A 30 VDC/60 VAC |
| Minimum Permissible Current Rating | 1mA @ 5 VDC |

RJ45 Connection Input / Output

| | |
|---------------------------------------|----------------|
| Temp. Comp. Battery (with ext. probe) | Yes - Optional |
| Remote monitoring display | Yes - Optional |
| Can Bus | No |

Environment

| | |
|--------------------------------------|--------------------------------|
| Insulation voltage (IN/OUT) | 3000 VAC |
| Insulation voltage (input / ground) | 1605 VAC |
| Insulation voltage (Output / ground) | 500 VAC |
| Protection Class (EN/IEC 60529) | IP20 |
| Pollution Degree Environment | 2 |
| Connection TB, Screw Terminal | 2,5 mm ² (24-14AWG) |
| Protection class (Ground Connected) | Class I |
| Dimensions (WxHxD) | 65x115x135 mm |
| 2.56x4.53x5.32 in | |
| Weight (approx.) | 0.6 kg (1.35 Lbs) |

Safety and EMC

| | |
|-------------------------------------|-----------------------|
| Battery charger standard compliance | IEC/EN 60335-2-29 |
| Safety standards compliance: | EN60950 / UL1950 / CE |
| Fire Detection and alarm compliance | EN54-4 |
| EMC Directive | 89/336/EEC |
| Charging cycle | DIN41773 |
| Emission | IEC 61000-6-4 |
| Immunity | IEC 61000-6-2 |

The Altech DC-UPS system is designed to charge and monitor all battery types, by selecting the battery type via jumpers. The predefined curves include Open Lead Acid, Sealed Lead Acid, Gel, Ni-Cd (optional) battery types. The charging curve are programmed to automatically switch between Recovery Charge, Boost charge and Trickle charge. The continuous battery efficiency monitoring, reduces battery damage risk and allows a safe operation in permanent connection.

A compact and rugged metal case with DIN rail mounting bracket provide an easy installation and an IP20 protection.

Jumper for Battery Type Selection



Jumper for Functional Setting



- 1 Jumper present: life test enabled.
- 2 Jumper present: fast test enabled.
- 3 Jumper present: fast recovery charge enabled only for size 3. Possibility to recharge the battery also when the voltage is close to zero with the maximum power of the device.



- PS Class 2 Series Compact Housing
- PSA Flex Series 1 Phase
- PSB Flex Series 2 & 3 Phase
- PS-S Slim Series Plastic Housing
- PS Low Profile Series Plastic Housing
- PS Industrial Series 1, 2 & 3 Phase
- PS C & W Series 1 and 2 Phase
- CBI Type DC UPS Systems
- CB Type Battery Chargers
- Accessories
- Appendix



CBI126A DC UPS



Features:

- Input: Single-phase 115 - 277 VAC
- Output Load: power supply 12 VDC; 6 A
- Output: Battery charging 12 VDC; 6 A
- Suited for the following battery types:
Open Lead Acid, Sealed Lead Acid, lead Gel and Ni-Cd (option)
- Automatic diagnostic of battery status.
- Switching technology, output voltage 10-14.4 VDC
- Three charging levels: Boost, trickle and recovery
- Protection degree IP20 - DIN rail mountable

INPUT

OUTPUT

PROTECTION

LOAD OUTPUT

BATTERY OUTPUT

OTHERS

Cat. No.

CBI126A

| | |
|---|---|
| Nominal Input Voltage | 115 ~ 230 ~ 277 VAC |
| Voltage range | 90 – 305 VAC |
| Inrush Current ($V_n - I_n$ nom. Load). I ² t | ≤11 A ≤ 5 msec |
| Frequency | 47 – 63 Hz |
| Input Current (115 – 230 VAC) | 2.8 ~ 1.3 A |
| Internal fuse (factory replaceable) | 4 A |
| External Fuse (recommended) MCB curve B | 10 A |
| Output Voltage (V_n) / Nominal Current (I_n) | 12 VDC / 6A |
| Output Current I_n | 6 A |
| Efficiency (at 50% of rated current) | ≥ 90 % |
| Turn-On delay after applying input voltage | 1 sec. (max) |
| Start up with Strong Load (capacitive load) | Yes, Unlimited |
| Dissipation power load max | 17 W |
| Short-circuit protection | Yes |
| Over Load protection | Yes |
| Over Voltage Output protection | Yes (typ. 35 VDC) |
| Over Temperature protection | Yes |
| Output voltage (at I_n) | 10 ~ 14.4 VDC |
| Nominal current I_{load} | 1.1 x I_n A ± 5% |
| Continuous current (without battery) $I_{load} = I_n$ | 6 A |
| Continuous current (with battery) $I_{load} = I_n + I_{batt}$ | 12 A |
| Max. Current Output Load (Main) I_{load} (4 sec.) | 18 A max. |
| Max. Current Output Load (Back Up) I_{load} (4 sec.) | 12 A max. |
| Push Button or Remote Input Control (RTCONN cable) | Start From Battery Without Main |
| Time Buffering; min (switch output off without main input) | ∞: standard 5 min.: Require SW |
| Protection alarm against total discharge | 9-10 VDC battery voltage |
| Threshold alarm for battery almost flat | 10-11 VDC battery voltage |
| Boost charge (25 °C) (at I_n) | 14.4 VDC |
| Max. time Bust Charge | 15 h |
| Min. time Bust Charge | 1 min. |
| Trickle charge (25 °C) (at I_n) | 13.75 VDC |
| Jumper Configuration battery type (V cell) Ni-Cd (optional) | 2.23; 2.25; 2.27; 2.30; NiCd: 1.50 (10 elem.) |
| Recovery Charge | 2 ~ 9 VDC |
| Charging current max I_{batt} | 6 A ± 5% |
| Charging current limiting I_{adj} | 20 – 100 % / I_{batt} |
| Reverse battery protection | Yes |
| Sulfated battery check | Yes by Jumper |
| Detection of element in short circuit | Yes |
| Quiescent Current | ≤ 5 mA |
| Charging Curve automatic: I_{UoUo} | 3 stage |
| Remote Input Control (RTCONN cable) | Boost /Trickle / Recovery |
| Ambient temperature (operation) | -25 – +70°C |
| De Rating $T_a > 50°C$ | - 2.5%(I_n) / °C |
| Ambient temperature Storage | -40 – +85°C |
| Humidity at 25°C no condensation | 95% |
| Cooling | Auto convection |
| MTBF (IEC 61709) | > 300.000 h |

CBI126A DC UPS

The Altech DC-UPS system is built to optimize power management. The available power is automatically allocated between load and battery, supplying power to the load is the first priority. For high inrush applications the charging power will reroute automatically to the load. In this case the maximum available current on the load output is two times the value of the device rated current.

The Battery Care concept based on algorithms that achieve rapid and automatic charging, battery optimization during charging time, flat batteries recovery and real time diagnostic. The Real Time Auto-diagnostic system, monitors battery faults, sulfated battery, short circuit battery elements, reverse polarity connection, battery disconnect. This conditions are detected and identified by the number of blinks of the diagnosis Led.

Signal Output Contacts

| | |
|--------------------------------------|------------------|
| Main or Backup Power | Yes |
| Battery Power Low | Yes |
| Battery Fault | Yes |
| Max. Current Rating (Resistive Load) | 1A 30 VDC/60 VAC |
| Minimum Permissible Current Rating | 1mA @ 5 VDC |

RJ45 Connection Input/Output

| | |
|---------------------------------------|----------------|
| Temp. Comp. Battery (with ext. probe) | Yes - Optional |
| Remote monitoring display | Yes - Optional |
| Can Bus | No |

Environment

| | |
|--------------------------------------|--------------------------------|
| Insulation voltage (IN/OUT) | 3000 VAC |
| Insulation voltage (input / ground) | 1605 VAC |
| Insulation voltage (Output / ground) | 500 VAC |
| Protection Class (EN/IEC 60529) | IP20 |
| Pollution Degree Environment | 2 |
| Connection TB, Screw Terminal | 2,5 mm ² (24-14AWG) |
| Protection class (Ground Connected) | Class I |
| Dimensions (WxHxD) | 65x115x135 mm |
| 2.56x4.53x5.32 in | |
| Weight (approx.) | 0.6 kg (1.35 Lbs) |

Safety and EMC

| | |
|-------------------------------------|-----------------------|
| Battery charger standard compliance | IEC/EN 60335-2-29 |
| Safety standards compliance: | EN60950 / UL1950 / CE |
| Fire Detection and alarm compliance | EN54-4 |
| EMC Directive | 89/336/EEC |
| Charging cycle | DIN41773 |
| Emission | IEC 61000-6-4 |
| Immunity | IEC 61000-6-2 |

The Altech DC-UPS system is designed to charge and monitor all battery types, by selecting the battery type via jumpers. The predefined curves include Open Lead Acid, Sealed Lead Acid, Gel, Ni-Cd (optional) battery types. The charging curve are programmed to automatically switch between Recovery Charge, Boost charge and Trickle charge. The continuous battery efficiency monitoring, reduces battery damage risk and allows a safe operation in permanent connection.

A compact and rugged metal case with DIN rail mounting bracket provide an easy installation and an IP20 protection.

Jumper for Battery Type Selection

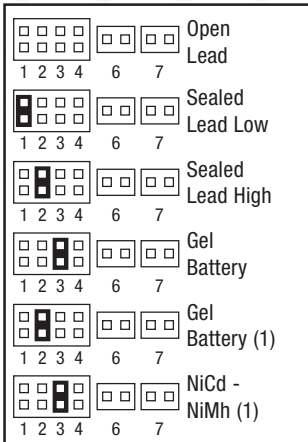

Jumper for Functional Setting

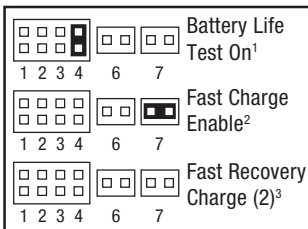

- 1 Jumper present: life test enabled.
- 2 Jumper present: fast test enabled.
- 3 Jumper present: fast recovery charge enabled only for size 3. Possibility to recharge the battery also when the voltage is close to zero with the maximum power of the device.

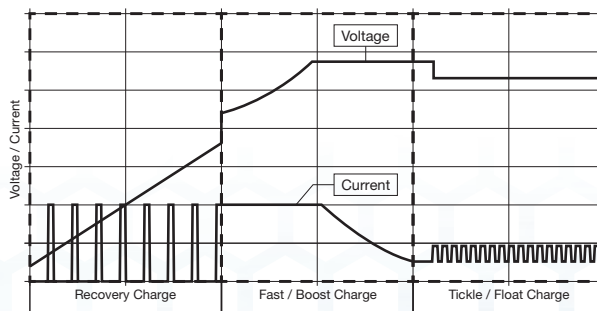

PS Class 2 Series Compact Housing

PSA Flex Series 1 Phase

PSB Flex Series 2 & 3 Phase

PS-S Slim Series Plastic Housing

PS Low Profile Series Plastic Housing

PS Industrial Series 1, 2 & 3 Phase

PS C & W Series 1 and 2 Phase

CBI Type DC UPS Systems

CB Type Battery Chargers

Accessories

Appendix



CBI1210A DC UPS



Features:

- Input: Single-phase 115 - 277 VAC
- Output Load: power supply 12 VDC; 10 A
- Output: Battery charging 12 VDC; 10 A
- Suited for the following battery types: Open Lead Acid, Sealed Lead Acid, lead Gel and Ni-Cd (option)
- Automatic diagnostic of battery status.
- Switching technology, output voltage 10-14.4 VDC
- Three charging levels: Boost, trickle and recovery
- Protection degree IP20 - DIN rail mountable

INPUT

OUTPUT

PROTECTION

LOAD OUTPUT

BATTERY OUTPUT

OTHERS

Cat. No.

CBI1210A

| | |
|---|---|
| Nominal Input Voltage | 115 ~ 230 ~ 277 VAC |
| Voltage range | 90 – 305 VAC |
| Inrush Current ($V_n - I_n$ nom. Load). I ² t | ≤11 A ≤ 5 msec |
| Frequency | 47 – 63 Hz |
| Input Current (115 – 230 VAC) | 2.8 ~ 1.3 A |
| Internal fuse (factory replaceable) | 4 A |
| External Fuse (recommended) MCB curve B | 10 A |
| Output Voltage (V_n) / Nominal Current (I_n) | 12 VDC / 10A |
| Output Current I_n | 10 A |
| Efficiency (at 50% of rated current) | ≥ 90 % |
| Turn-On delay after applying input voltage | 1 sec. (max) |
| Start up with Strong Load (capacitive load) | Yes, Unlimited |
| Dissipation power load max | 17 W |
| Short-circuit protection | Yes |
| Over Load protection | Yes |
| Over Voltage Output protection | Yes (typ. 35 VDC) |
| Over Temperature protection | Yes |
| Output voltage (at I_n) | 10 ~ 14.4 VDC |
| Nominal current I_{load} | 1.1 x I_n A ± 5% |
| Continuous current (without battery) $I_{load} = I_n$ | 10 A |
| Continuous current (with battery) $I_{load} = I_n + I_{batt}$ | 20 A |
| Max. Current Output Load (Main) I_{load} (4 sec.) | 30 A max. |
| Max. Current Output Load (Back Up) I_{load} (4 sec.) | 20 A max. |
| Push Button or Remote Input Control (RTCONN cable) | Start From Battery Without Main |
| Time Buffering; min (switch output off without main input) | ∞: standard 5 min.: Require SW |
| Protection alarm against total discharge | 9-10V DC battery |
| Threshold alarm for battery almost flat | 10-11 V DC battery |
| Boost charge (25 °C) (at I_n) | 14.4 VDC |
| Max. time Bust Charge | 15 h |
| Min. time Bust Charge | 1 min. |
| Trickle charge (25 °C) (at I_n) | 13.75 VDC |
| Jumper Configuration battery type (V cell) Ni-Cd (optional) | 2.23; 2.25; 2.27; 2.30; NiCd: 1.50 (10 elem.) |
| Recovery Charge | 2 ~ 9 VDC |
| Charging current max I_{batt} | 10 A ± 5% |
| Charging current limiting I_{adj} | 20 – 100 % / I_{batt} |
| Reverse battery protection | Yes |
| Sulfated battery check | Yes by Jumper |
| Detection of element in short circuit | Yes |
| Quiescent Current | ≤ 5 mA |
| Charging Curve automatic: I_{UoUo} | 3 stage |
| Remote Input Control (RTCONN cable) | Boost /Trickle / Recovery |
| Ambient temperature (operation) | -25 – +70°C |
| De Rating $T_a > 50°C$ | - 2.5%(I_n) / °C |
| Ambient temperature Storage | -40 – +85°C |
| Humidity at 25°C no condensation | 95% |
| Cooling | Auto convection |
| MTBF | > 300.000 h (IEC 61709) |

CBI1210A DC UPS

The Altech DC-UPS system is built to optimize power management. The available power is automatically allocated between load and battery, supplying power to the load is the first priority. For high inrush applications the charging power will reroute automatically to the load. In this case the maximum available current on the load output is two times the value of the device rated current.

The Battery Care concept based on algorithms that achieve rapid and automatic charging, battery optimization during charging time, flat batteries recovery and real time diagnostic. The Real Time Auto-diagnostic system, monitors battery faults, sulfated battery, short circuit battery elements, reverse polarity connection, battery disconnect. This conditions are detected and identified by the number of blinks of the diagnosis Led.

Signal Output Contacts

| | |
|--------------------------------------|------------------|
| Main or Backup Power | Yes |
| Battery Power Low | Yes |
| Battery Fault | Yes |
| Max. Current Rating (Resistive Load) | 1A 30 VDC/60 VAC |
| Minimum Permissible Current Rating | 1mA @ 5 VDC |

RJ45 Connection Input/Output

| | |
|---------------------------------------|----------------|
| Temp. Comp. Battery (with ext. probe) | Yes - Optional |
| Remote monitoring display | Yes - Optional |
| Can Bus | No |

Environment

| | |
|--------------------------------------|--------------------------------|
| Insulation voltage (IN/OUT) | 3000 VAC |
| Insulation voltage (input / ground) | 1605 VAC |
| Insulation voltage (Output / ground) | 500 VAC |
| Protection Class (EN/IEC 60529) | IP20 |
| Pollution Degree Environment | 2 |
| Connection TB, Screw Terminal | 2,5 mm ² (24-14AWG) |
| Protection class (Ground Connected) | Class I |
| Dimensions (WxHxD) | 65x115x135 mm |
| 2.56x4.53x5.32 in | |
| Weight (approx.) | 0.6 kg (1.35 Lbs) |

Safety and EMC

| | |
|-------------------------------------|-----------------------|
| Battery charger standard compliance | IEC/EN 60335-2-29 |
| Safety standards compliance: | EN60950 / UL1950 / CE |
| Fire Detection and alarm compliance | EN54-4 |
| EMC Directive | 89/336/EEC |
| Charging cycle | DIN41773 |
| Emission | IEC 61000-6-4 |
| Immunity | IEC 61000-6-2 |

The Altech DC-UPS system is designed to charge and monitor all battery types, by selecting the battery type via jumpers. The predefined curves include Open Lead Acid, Sealed Lead Acid, Gel, Ni-Cd (optional) battery types. The charging curve are programmed to automatically switch between Recovery Charge, Boost charge and Trickle charge. The continuous battery efficiency monitoring, reduces battery damage risk and allows a safe operation in permanent connection.

A compact and rugged metal case with DIN rail mounting bracket provide an easy installation and an IP20 protection.

Jumper for Battery Type Selection



Jumper for Functional Setting



- 1 Jumper present: life test enabled.
- 2 Jumper present: fast test enabled.
- 3 Jumper present: fast recovery charge enabled only for size 3. Possibility to recharge the battery also when the voltage is close to zero with the maximum power of the device.

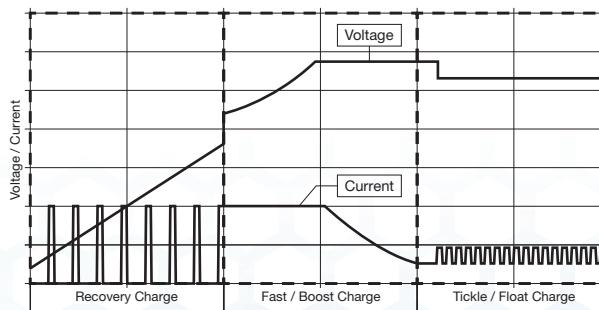

PSC Class 2 Series Compact Housing

PSA Flex Series 1 Phase

PSB Flex Series 2 & 3 Phase

PS-S Slim Series Plastic Housing

PS Low Profile Series Plastic Housing

PS Industrial Series 1, 2 & 3 Phase

PS C & W Series 1 and 2 Phase

CBI Type DC UPS Systems

CB Type Battery Chargers

Accessories

Appendix



CBI1235A DC UPS



Features:

- Input: Single-phase 115 - 277 VAC
- Output Load: power supply 12 VDC; 35 A
- Output: Battery charging 12 VDC; 35 A
- Suited for the following battery types: Open Lead Acid, Sealed Lead Acid, lead Gel and Ni-Cd (option)
- Automatic diagnostic of battery status.
- Switching technology, output voltage 10-14.4 VDC
- Three charging levels: Boost, trickle and recovery
- Protection degree IP20 - DIN rail mountable

INPUT

OUTPUT

PROTECTION

LOAD OUTPUT

BATTERY OUTPUT

OTHERS

Cat. No.

CBI1235A

| | |
|---|---|
| Nominal Input Voltage | 115 / 230 ~ 277 VAC |
| Voltage range | 90 – 135 / 180-305 VAC |
| Inrush Current ($V_n - I_n$ nom. Load). I ² t | ≤35 A ≤ 5 msec |
| Frequency | 47 – 63 Hz |
| Input Current (115 – 230 VAC) | 8 ~ 4.2 A |
| Internal fuse (factory replaceable) | 10 A |
| External Fuse (recommended) MCB curve B | 16 A |
| Output Voltage (V_n) / Nominal Current (I_n) | 12 VDC / 35A |
| Output Current I_n | 35 A |
| Efficiency (at 50% of rated current) | ≥ 91 % |
| Turn-On delay after applying input voltage | 1 sec. (max) |
| Start up with Strong Load (capacitive load) | Yes, Unlimited |
| Dissipation power load max | 48 W |
| Short-circuit protection | Yes |
| Over Load protection | Yes |
| Over Voltage Output protection | Yes (typ. 35 VDC) |
| Over Temperature protection | Yes |
| Output voltage (at I_n) | 10 ~ 14.4 VDC |
| Nominal current I_{load} | 1.1 x I_n A ± 5% |
| Continuous current (without battery) $I_{load} = I_n$ | 35 A |
| Continuous current (with battery) $I_{load} = I_n + I_{batt}$ | 70 A |
| Max. Current Output Load (Main) I_{load} (4 sec.) | 105 A max. |
| Max. Current Output Load (Back Up) I_{load} (4 sec.) | 70 A max. |
| Push Button or Remote Input Control (RTCONN cable) | Start From Battery Without Main |
| Time Buffering; min (switch output off without main input) | 0.5, 1, 3, 5, 10, 15, 20, 30, 45, 60, ∞; Require SW |
| Protection alarm against total discharge | 9-10V DC battery |
| Threshold alarm for battery almost flat | 10-11 V DC battery |
| Boost charge (25 °C) (at I_n) | 14.4 VDC |
| Max. time Bust Charge | 15 h |
| Min. time Bust Charge | 1 min. |
| Trickle charge (25 °C) (at I_n) | 13.75 VDC |
| Jumper Configuration battery type (V cell) Ni-Cd (optional) | 2.23; 2.25; 2.27; 2.30; NiCd: 1.50 (10 elem.) |
| Recovery Charge | 2 ~ 9 VDC |
| Charging current max I_{batt} | 35 A ± 5% |
| Charging current limiting I_{adj} | 20 – 100 % / I_{batt} |
| Reverse battery protection | Yes |
| Sulfated battery check | Yes by Jumper |
| Detection of element in short circuit | Yes |
| Quiescent Current | ≤ 5 mA |
| Charging Curve automatic: I_{UoUo} | 3 stage |
| Remote Input Control (RTCONN cable) | Boost /Trickle / Recovery |
| Ambient temperature (operation) | -25 – +70°C |
| De Rating $T_a > 50°C$ | - 2.5%(In) / °C |
| Ambient temperature Storage | -40 – +85°C |
| Humidity at 25°C no condensation | 95% |
| Cooling | Auto convection |
| MTBF (IEC 61709) | > 300.000 h |

CBI1235A DC UPS

The Altech DC-UPS system is built to optimize power management. The available power is automatically allocated between load and battery, supplying power to the load is the first priority. For high inrush applications the charging power will reroute automatically to the load. In this case the maximum available current on the load output is two times the value of the device rated current.

The Battery Care concept based on algorithms that achieve rapid and automatic charging, battery optimization during charging time, flat batteries recovery and real time diagnostic. The Real Time Auto-diagnostic system, monitors battery faults, sulfated battery, short circuit battery elements, reverse polarity connection, battery disconnect. This conditions are detected and identified by the number of blinks of the diagnosis Led.

Signal Output Contacts

| | |
|--------------------------------------|------------------|
| Main or Backup Power | Yes |
| Battery Power Low | Yes |
| Battery Fault | Yes |
| Max. Current Rating (Resistive Load) | 1A 30 VDC/60 VAC |
| Minimum Permissible Current Rating | 1mA @ 5 VDC |

RJ45 Connection Input/Output

| | |
|---------------------------------------|----------------|
| Temp. Comp. Battery (with ext. probe) | Yes - Optional |
| Remote monitoring display | Yes - Optional |
| Can Bus | Yes - Optional |

Environment

| | |
|--------------------------------------|------------------------------|
| Insulation voltage (IN/OUT) | 3000 VAC |
| Insulation voltage (input / ground) | 1605 VAC |
| Insulation voltage (Output / ground) | 500 VAC |
| Protection Class (EN/IEC 60529) | IP20 |
| Pollution Degree Environment | 2 |
| Connection TB, Screw Terminal | 4 mm ² (30–10AWG) |
| Protection class (Ground Connected) | Class I |
| Dimensions (WxHxD) | 150x115x135 mm |
| 5.91x4.53x5.32 in | |
| Weight (approx.) | 1.55 kg (3.5 Lbs) |

Safety and EMC

| | |
|-------------------------------------|-----------------------|
| Battery charger standard compliance | IEC/EN 60335-2-29 |
| Safety standards compliance: | EN60950 / UL1950 / CE |
| Fire Detection and alarm compliance | EN54-4 |
| EMC Directive | 89/336/EEC |
| Charging cycle | DIN41773 |
| Emission | IEC 61000-6-4 |
| Immunity | IEC 61000-6-2 |

The Altech DC-UPS system is designed to charge and monitor all battery types, by selecting the battery type via jumpers. The predefined curves include Open Lead Acid, Sealed Lead Acid, Gel, Ni-Cd (optional) battery types. The charging curve are programmed to automatically switch between Recovery Charge, Boost charge and Trickle charge. The continuous battery efficiency monitoring, reduces battery damage risk and allows a safe operation in permanent connection.

A compact and rugged metal case with DIN rail mounting bracket provide an easy installation and an IP20 protection.

Jumper for Battery Type Selection

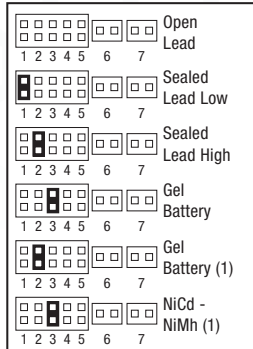

Jumper for Functional Setting



- 1 Jumper present: life test enabled.
- 2 Jumper present: fast test enabled.
- 3 Jumper present: fast recovery charge enabled only for size 3. Possibility to recharge the battery also when the voltage is close to zero with the maximum power of the device.



PSC Class 2 Series
Compact Housing

PSA Flex Series
1 Phase

PSB Flex Series
2 & 3 Phase

PS-S Slim Series
Plastic Housing

PS Low Profile Series
Plastic Housing

PS Industrial Series
1, 2 & 3 Phase

PS C & W Series
1 and 2 Phase

CBI Type
DC UPS Systems

CB Type
Battery Chargers

Accessories

Appendix



CBI243A DC UPS



Features:

- Input: Single-phase 115 - 277 VAC
- Output Load: power supply 24 VDC; 3 A
- Output: Battery charging 24 VDC; 3 A
- Suited for the following battery types: Open Lead Acid, Sealed Lead Acid, lead Gel and Ni-Cd (option)
- Automatic diagnostic of battery status.
- Switching technology, output voltage 22-28.8 VDC
- Three charging levels: Boost, trickle and recovery
- Protection degree IP20 - DIN rail mountable

INPUT

OUTPUT

PROTECTION

LOAD OUTPUT

BATTERY OUTPUT

OTHERS

Cat. No.

CBI243A

| | |
|---|---|
| Nominal Input Voltage | 115 ~ 230 ~ 277 VAC |
| Voltage range | 90 – 305 VAC |
| Inrush Current ($V_n - I_n$ nom. Load). I ² t | ≤11 A ≤ 5 msec |
| Frequency | 47 – 63 Hz |
| Input Current (115 – 230 VAC) | 2.8 ~ 1.3 A |
| Internal fuse (factory replaceable) | 4 A |
| External Fuse (recommended) MCB curve B | 10 A |
| Output Voltage (V_n) / Nominal Current (I_n) | 24 VDC / 3A |
| Output Current I_n | 3 A |
| Efficiency (at 50% of rated current) | ≥ 90 % |
| Turn-On delay after applying input voltage | 1 sec. (max) |
| Start up with Strong Load (capacitive load) | Yes, Unlimited |
| Dissipation power load max | 13 W |
| Short-circuit protection | Yes |
| Over Load protection | Yes |
| Over Voltage Output protection | Yes (typ. 35 VDC) |
| Over Temperature protection | Yes |
| Output voltage (at I_n) | 22 ~ 28.8 VDC |
| Nominal current I_{load} | 1.1 x I_n A ± 5% |
| Continuous current (without battery) $I_{load} = I_n$ | 3 A |
| Continuous current (with battery) $I_{load} = I_n + I_{batt}$ | 6 A |
| Max. Current Output Load (Main) I_{load} (4 sec.) | 9 A max. |
| Max. Current Output Load (Back Up) I_{load} (4 sec.) | 6 A max. |
| Push Button or Remote Input Control (RTCONN cable) | Start From Battery Without Main |
| Time Buffering; min (switch output off without main input) | ∞: standard 5 min.: Require SW |
| Protection alarm against total discharge | 19-20V DC battery |
| Threshold alarm for battery almost flat | 20-21 V DC battery |
| Boost charge (25 °C) (at I_n) | 28.8 VDC |
| Max. time Bust Charge | 15 h |
| Min. time Bust Charge | 1 min. |
| Trickle charge (25 °C) (at I_n) | 27.5 VDC |
| Jumper Configuration battery type (V cell) Ni-Cd (optional) | 2.23; 2.25; 2.27; 2.30; NiCd: 1.50 (20 elem.) |
| Recovery Charge | 2 ~ 16 VDC |
| Charging current max I_{batt} | 3 A ± 5% |
| Charging current limiting I_{adj} | 20 – 100 % / I_{batt} |
| Reverse battery protection | Yes |
| Sulfated battery check | Yes by Jumper |
| Detection of element in short circuit | Yes |
| Quiescent Current | ≤ 5 mA |
| Charging Curve automatic: I_{UoUo} | 3 stage |
| Remote Input Control (RTCONN cable) | Boost /Trickle / Recovery |
| Ambient temperature (operation) | -25 – +70°C |
| De Rating $T_a > 50°C$ | - 2.5%(I_n) / °C |
| Ambient temperature Storage | -40 – +85°C |
| Humidity at 25°C no condensation | 95% |
| Cooling | Auto convection |
| MTBF (IEC 61709) | > 300.000 h |

CBI243A DC UPS

The Altech DC-UPS system is built to optimize power management. The available power is automatically allocated between load and battery, supplying power to the load is the first priority. For high inrush applications the charging power will reroute automatically to the load. In this case the maximum available current on the load output is two times the value of the device rated current.

The Battery Care concept based on algorithms that achieve rapid and automatic charging, battery optimization during charging time, flat batteries recovery and real time diagnostic. The Real Time Auto-diagnostic system, monitors battery faults, sulfated battery, short circuit battery elements, reverse polarity connection, battery disconnect. This conditions are detected and identified by the number of blinks of the diagnosis Led.

Signal Output Contacts

| | |
|--------------------------------------|------------------|
| Main or Backup Power | Yes |
| Battery Power Low | Yes |
| Battery Fault | Yes |
| Max. Current Rating (Resistive Load) | 1A 30 VDC/60 VAC |
| Minimum Permissible Current Rating | 1mA @ 5 VDC |

RJ45 Connection Input/Output

| | |
|---------------------------------------|----------------|
| Temp. Comp. Battery (with ext. probe) | Yes - Optional |
| Remote monitoring display | Yes - Optional |
| Can Bus | No |

Environment

| | |
|--------------------------------------|--------------------------------|
| Insulation voltage (IN/OUT) | 3000 VAC |
| Insulation voltage (input / ground) | 1605 VAC |
| Insulation voltage (Output / ground) | 500 VAC |
| Protection Class (EN/IEC 60529) | IP20 |
| Pollution Degree Environment | 2 |
| Connection TB, Screw Terminal | 2,5 mm ² (24-14AWG) |
| Protection class (Ground Connected) | Class I |
| Dimensions (WxHxD) | 65x115x135 mm |
| 2.56x4.53x5.32 in | |
| Weight (approx.) | 0.6 kg (1.35 Lbs) |

Safety and EMC

| | |
|-------------------------------------|-----------------------|
| Battery charger standard compliance | IEC/EN 60335-2-29 |
| Safety standards compliance: | EN60950 / UL1950 / CE |
| Fire Detection and alarm compliance | EN54-4 |
| EMC Directive | 89/336/EEC |
| Charging cycle | DIN41773 |
| Emission | IEC 61000-6-4 |
| Immunity | IEC 61000-6-2 |

The Altech DC-UPS system is designed to charge and monitor all battery types, by selecting the battery type via jumpers. The predefined curves include Open Lead Acid, Sealed Lead Acid, Gel, Ni-Cd (optional) battery types. The charging curve are programmed to automatically switch between Recovery Charge, Boost charge and Trickle charge. The continuous battery efficiency monitoring, reduces battery damage risk and allows a safe operation in permanent connection.

A compact and rugged metal case with DIN rail mounting bracket provide an easy installation and an IP20 protection.

Jumper for Battery Type Selection



Jumper for Functional Setting



- 1 Jumper present: life test enabled.
- 2 Jumper present: fast test enabled.
- 3 Jumper present: fast recovery charge enabled only for size 3. Possibility to recharge the battery also when the voltage is close to zero with the maximum power of the device.

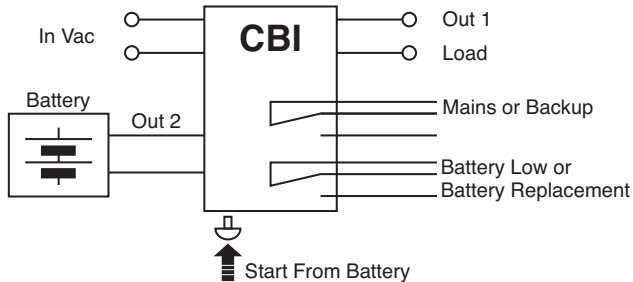

PS Class 2 Series Compact Housing

PSA Flex Series 1 Phase

PSB Flex Series 2 & 3 Phase

PS-S Slim Series Plastic Housing

PS Low Profile Series Plastic Housing

PS Industrial Series 1, 2 & 3 Phase

PS C & W Series 1 and 2 Phase

CBI Type DC UPS Systems

CB Type Battery Chargers

Accessories

Appendix



CBI245A DC UPS



Features:

- Input: Single-phase 115 - 277 VAC
- Output Load: power supply 24 VDC; 5 A
- Output: Battery charging 24 VDC; 5 A
- Suited for the following battery types:
Open Lead Acid, Sealed Lead Acid, lead Gel and Ni-Cd (option)
- Automatic diagnostic of battery status.
- Switching technology, output voltage 22-28.8 VDC
- Three charging levels: Boost, trickle and recovery
- Protection degree IP20 - DIN rail mountable

INPUT

OUTPUT

PROTECTION

LOAD OUTPUT

BATTERY OUTPUT

OTHERS

Cat. No.

CBI245A

| | |
|---|---|
| Nominal Input Voltage | 115 ~ 230 ~ 277 VAC |
| Voltage range | 90 – 305 VAC |
| Inrush Current ($V_n - I_n$ nom. Load). I ² t | ≤11 A ≤ 5 msec |
| Frequency | 47 – 63 Hz |
| Input Current (115 – 230 VAC) | 2.8 ~ 1.3 A |
| Internal fuse (factory replaceable) | 4 A |
| External Fuse (recommended) MCB curve B | 10 A |
| Output Voltage (V_n) / Nominal Current (I_n) | 24 VDC / 5A |
| Output Current I_n | 5 A |
| Efficiency (at 50% of rated current) | ≥ 90 % |
| Turn-On delay after applying input voltage | 1 sec. (max) |
| Start up with Strong Load (capacitive load) | Yes, Unlimited |
| Dissipation power load max | 17 W |
| Short-circuit protection | Yes |
| Over Load protection | Yes |
| Over Voltage Output protection | Yes (typ. 35 VDC) |
| Over Temperature protection | Yes |
| Output voltage (at I_n) | 22 ~ 28.8 VDC |
| Nominal current I_{load} | 1.1 x I_n A ± 5% |
| Continuous current (without battery) $I_{load} = I_n$ | 5 A |
| Continuous current (with battery) $I_{load} = I_n + I_{batt}$ | 10 A |
| Max. Current Output Load (Main) I_{load} (4 sec.) | 15 A max. |
| Max. Current Output Load (Back Up) I_{load} (4 sec.) | 10 A max. |
| Push Button or Remote Input Control (RTCONN cable) | Start From Battery Without Main |
| Time Buffering; min (switch output off without main input) | ∞: standard 5 min.: Require SW |
| Protection alarm against total discharge | 19-20V DC battery |
| Threshold alarm for battery almost flat | 20-21 V DC battery |
| Boost charge (25 °C) (at I_n) | 28.8 VDC |
| Max. time Bust Charge | 15 h |
| Min. time Bust Charge | 1 min. |
| Trickle charge (25 °C) (at I_n) | 27.5 VDC |
| Jumper Configuration battery type (V cell) Ni-Cd (optional) | 2.23; 2.25; 2.27; 2.30; NiCd: 1.50 (20 elem.) |
| Recovery Charge | 2 ~ 16 VDC |
| Charging current max I_{batt} | 5 A ± 5% |
| Charging current limiting I_{adj} | 20 – 100 % / I_{batt} |
| Reverse battery protection | Yes |
| Sulfated battery check | Yes by Jumper |
| Detection of element in short circuit | Yes |
| Quiescent Current | ≤ 5 mA |
| Charging Curve automatic: I_{UoUo} | 3 stage |
| Remote Input Control (RTCONN cable) | Boost /Trickle / Recovery |
| Ambient temperature (operation) | -25 – +70°C |
| De Rating $T_a > 50°C$ | - 2.5%(I_n) / °C |
| Ambient temperature Storage | -40 – +85°C |
| Humidity at 25°C no condensation | 95% |
| Cooling | Auto convection |
| MTBF (IEC 61709) | > 300.000 h |

CBI245A DC UPS

The Altech DC-UPS system is built to optimize power management. The available power is automatically allocated between load and battery, supplying power to the load is the first priority. For high inrush applications the charging power will reroute automatically to the load. In this case the maximum available current on the load output is two times the value of the device rated current.

The Battery Care concept based on algorithms that achieve rapid and automatic charging, battery optimization during charging time, flat batteries recovery and real time diagnostic. The Real Time Auto-diagnostic system, monitors battery faults, sulfated battery, short circuit battery elements, reverse polarity connection, battery disconnect. This conditions are detected and identified by the number of blinks of the diagnosis Led.

Signal Output Contacts

| | |
|--------------------------------------|------------------|
| Main or Backup Power | Yes |
| Battery Power Low | Yes |
| Battery Fault | Yes |
| Max. Current Rating (Resistive Load) | 1A 30 VDC/60 VAC |
| Minimum Permissible Current Rating | 1mA @ 5 VDC |

RJ45 Connection Input/Output

| | |
|---------------------------------------|----------------|
| Temp. Comp. Battery (with ext. probe) | Yes - Optional |
| Remote monitoring display | Yes - Optional |
| Can Bus | No |

Environment

| | |
|--------------------------------------|--------------------------------|
| Insulation voltage (IN/OUT) | 3000 VAC |
| Insulation voltage (input / ground) | 1605 VAC |
| Insulation voltage (Output / ground) | 500 VAC |
| Protection Class (EN/IEC 60529) | IP20 |
| Pollution Degree Environment | 2 |
| Connection TB, Screw Terminal | 2,5 mm ² (24-14AWG) |
| Protection class (Ground Connected) | Class I |
| Dimensions (WxHxD) | 65x115x135 mm |
| 2.56x4.53x5.32 in | |
| Weight (approx.) | 0.6 kg (1.35 Lbs) |

Safety and EMC

| | |
|-------------------------------------|-----------------------|
| Battery charger standard compliance | IEC/EN 60335-2-29 |
| Safety standards compliance: | EN60950 / UL1950 / CE |
| Fire Detection and alarm compliance | EN54-4 |
| EMC Directive | 89/336/EEC |
| Charging cycle | DIN41773 |
| Emission | IEC 61000-6-4 |
| Immunity | IEC 61000-6-2 |

The Altech DC-UPS system is designed to charge and monitor all battery types, by selecting the battery type via jumpers. The predefined curves include Open Lead Acid, Sealed Lead Acid, Gel, Ni-Cd (optional) battery types. The charging curve are programmed to automatically switch between Recovery Charge, Boost charge and Trickle charge. The continuous battery efficiency monitoring, reduces battery damage risk and allows a safe operation in permanent connection.

A compact and rugged metal case with DIN rail mounting bracket provide an easy installation and an IP20 protection.

Jumper for Battery Type Selection



Jumper for Functional Setting

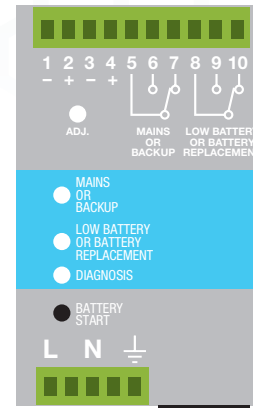

- 1 Jumper present: life test enabled.
- 2 Jumper present: fast test enabled.
- 3 Jumper present: fast recovery charge enabled only for size 3. Possibility to recharge the battery also when the voltage is close to zero with the maximum power of the device.



PSC Class 2 Series
Compact Housing

PSA Flex Series
1 Phase

PSB Flex Series
2 & 3 Phase

PS-S Slim Series
Plastic Housing

PS Low Profile Series
Plastic Housing

PS Industrial Series
1, 2 & 3 Phase

PS C & W Series
1 and 2 Phase

CBI Type
DC UPS Systems

CB Type
Battery Chargers

Accessories

Appendix



CBI2410A DC UPS



Features:

- Input: Single-phase 115 - 277 VAC
- Output Load: power supply 24 VDC; 10 A
- Output: Battery charging 24 VDC; 10 A
- Suited for the following battery types:
Open Lead Acid, Sealed Lead Acid, lead Gel and Ni-Cd (option)
- Automatic diagnostic of battery status.
- Switching technology, output voltage 22-28.8 VDC
- Three charging levels: Boost, trickle and recovery
- Protection degree IP20 - DIN rail mountable

INPUT

OUTPUT

PROTECTION

LOAD OUTPUT

BATTERY OUTPUT

OTHERS

Cat. No.

CBI2410A

| | |
|---|---|
| Nominal Input Voltage | 115 / 230 ~ 277 VAC |
| Voltage range | 90-135 / 180-305 VAC |
| Inrush Current ($V_n - I_n$ nom. Load). I^2t | $\leq 16 A \leq 5$ msec |
| Frequency | 47 – 63 Hz |
| Input Current (115 – 230 VAC) | 3.3 ~ 2.2 A |
| Internal fuse (factory replaceable) | 6.3 A |
| External Fuse (recommended) MCB curve B | 16 A |
| Output Voltage (V_n) / Nominal Current (I_n) | 24 VDC / 10A |
| Output Current I_n | 10 A |
| Efficiency (at 50% of rated current) | ≥ 83 % |
| Turn-On delay after applying input voltage | 1.5 sec. (max) |
| Start up with Strong Load (capacitive load) | Yes, Unlimited |
| Dissipation power load max | 28 W |
| Short-circuit protection | Yes |
| Over Load protection | Yes |
| Over Voltage Output protection | Yes (typ. 35 VDC) |
| Over Temperature protection | Yes |
| Output voltage (at I_n) | 22 ~ 28.8 VDC |
| Nominal current I_{load} | $1.1 \times I_n A \pm 5\%$ |
| Continuous current (without battery) $I_{load} = I_n$ | 10 A |
| Continuous current (with battery) $I_{load} = I_n + I_{batt}$ | 20 A |
| Max. Current Output Load (Main) I_{load} (4 sec.) | 30 A max. |
| Max. Current Output Load (Back Up) I_{load} (4 sec.) | 20 A max. |
| Push Button or Remote Input Control (RTCONN cable) | Start From Battery Without Main |
| Time Buffering; min (switch output off without main input) | ∞ : standard 5 min.: Require SW |
| Protection alarm against total discharge | 19-20V DC battery |
| Threshold alarm for battery almost flat | 20-21 V DC battery |
| Boost charge (25 °C) (at I_n) | 28.8 VDC |
| Max. time Bust Charge | 15 h |
| Min. time Bust Charge | 1 min. |
| Trickle charge (25 °C) (at I_n) | 27.5 VDC |
| Jumper Configuration battery type (V cell) Ni-Cd (optional) | 2.23; 2.25; 2.27; 2.30; NiCd: 1.50 (20 elem.) |
| Recovery Charge | 2 ~ 16 VDC |
| Charging current max I_{batt} | 10 A $\pm 5\%$ |
| Charging current limiting I_{adj} | 20 – 100 % / I_{batt} |
| Reverse battery protection | Yes |
| Sulfated battery check | Yes by Jumper |
| Detection of element in short circuit | Yes |
| Quiescent Current | ≤ 5 mA |
| Charging Curve automatic: I_{UoUo} | 3 stage |
| Remote Input Control (RTCONN cable) | Boost / Trickle / Recovery |
| Ambient temperature (operation) | -25 – +70°C |
| De Rating $T_a > 50^\circ C$ | - 2.5%(In) / °C |
| Ambient temperature Storage | -40 – +85°C |
| Humidity at 25°C no condensation | 95% |
| Cooling | Auto convention |
| MTBF (IEC 61709) | > 300.000 h |

CBI2410A DC UPS

The Altech DC-UPS system is built to optimize power management. The available power is automatically allocated between load and battery, supplying power to the load is the first priority. For high inrush applications the charging power will reroute automatically to the load. In this case the maximum available current on the load output is two times the value of the device rated current.

The Battery Care concept based on algorithms that achieve rapid and automatic charging, battery optimization during charging time, flat batteries recovery and real time diagnostic. The Real Time Auto-diagnostic system, monitors battery faults, sulfated battery, short circuit battery elements, reverse polarity connection, battery disconnect. This conditions are detected and identified by the number of blinks of the diagnosis Led.

Signal Output Contacts

| | |
|--------------------------------------|------------------|
| Main or Backup Power | Yes |
| Battery Power Low | Yes |
| Battery Fault | Yes |
| Max. Current Rating (Resistive Load) | 1A 30 VDC/60 VAC |
| Minimum Permissible Current Rating | 1mA @ 5 VDC |

RJ45 Connection Input/Output

| | |
|---------------------------------------|----------------|
| Temp. Comp. Battery (with ext. probe) | Yes - Optional |
| Remote monitoring display | Yes - Optional |
| Can Bus | No |

Environment

| | |
|--------------------------------------|--------------------------------|
| Insulation voltage (IN/OUT) | 3000 VAC |
| Insulation voltage (input / ground) | 1605 VAC |
| Insulation voltage (Output / ground) | 500 VAC |
| Protection Class (EN/IEC 60529) | IP20 |
| Pollution Degree Environment | 2 |
| Connection TB, Screw Terminal | 2,5 mm ² (24-14AWG) |
| Protection class (Ground Connected) | Class I |
| Dimensions (WxHxD) | 100x115x135 mm |
| 2.95x4.53x5.32 in | |
| Weight (approx.) | 0.85 kg (1.9 Lbs) |

Safety and EMC

| | |
|-------------------------------------|-----------------------|
| Battery charger standard compliance | IEC/EN 60335-2-29 |
| Safety standards compliance: | EN60950 / UL1950 / CE |
| Fire Detection and alarm compliance | EN54-4 |
| EMC Directive | 89/336/EEC |
| Charging cycle | DIN41773 |
| Emission | IEC 61000-6-4 |
| Immunity | IEC 61000-6-2 |

The Altech DC-UPS system is designed to charge and monitor all battery types, by selecting the battery type via jumpers. The predefined curves include Open Lead Acid, Sealed Lead Acid, Gel, Ni-Cd (optional) battery types. The charging curve are programmed to automatically switch between Recovery Charge, Boost charge and Trickle charge. The continuous battery efficiency monitoring, reduces battery damage risk and allows a safe operation in permanent connection.

A compact and rugged metal case with DIN rail mounting bracket provide an easy installation and an IP20 protection.

Jumper for Battery Type Selection

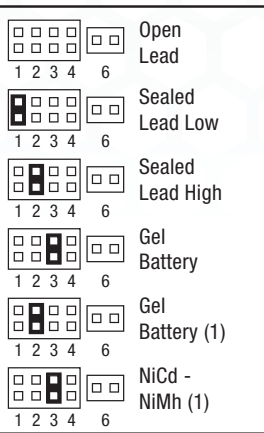

Jumper for Functional Setting

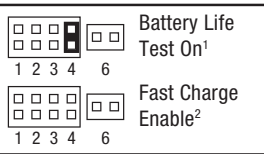

- 1 Jumper present: life test enabled.
- 2 Jumper present: fast test enabled.
- 3 Jumper present: fast recovery charge enabled only for size 3. Possibility to recharge the battery also when the voltage is close to zero with the maximum power of the device.

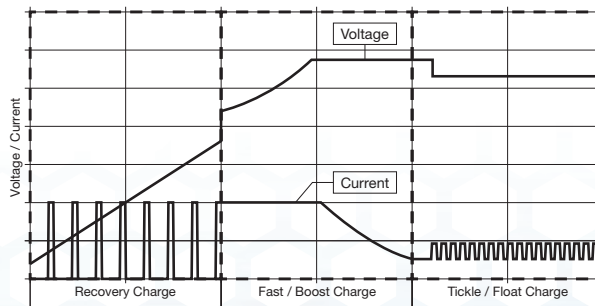
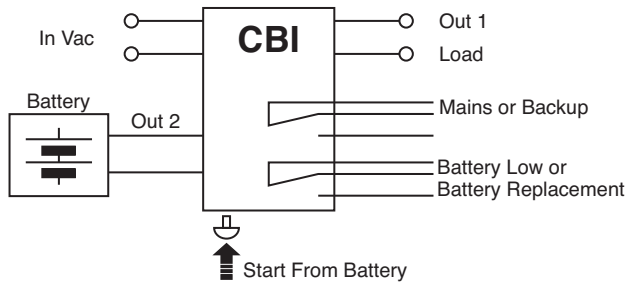

PSC Class 2 Series Compact Housing

PSA Flex Series 1 Phase

PSB Flex Series 2 & 3 Phase

PS-S Slim Series Plastic Housing

PS Low Profile Series Plastic Housing

PS Industrial Series 1, 2 & 3 Phase

PS C & W Series 1 and 2 Phase

CBI Type DC UPS Systems

CB Type Battery Chargers

Accessories

Appendix



CBI2420A DC UPS



Features:

- Input: Single-phase 115 - 277 VAC
- Output Load: power supply 24 VDC; 20 A
- Output: Battery charging 24 VDC; 20 A
- Suited for the following battery types:
Open Lead Acid, Sealed Lead Acid, lead Gel and Ni-Cd (option)
- Automatic diagnostic of battery status.
- Switching technology, output voltage 22-18.8 VDC
- Three charging levels: Boost, trickle and recovery
- Protection degree IP20 - DIN rail mountable

INPUT

OUTPUT

PROTECTION

LOAD OUTPUT

BATTERY OUTPUT

OTHERS

Cat. No.

CBI2420A

| | |
|---|--|
| Nominal Input Voltage | 115 / 230 ~ 277 VAC |
| Voltage range | 90-135 / 180-305 VAC |
| Inrush Current ($V_n - I_n$ nom. Load). I^2t | $\leq 35 A \leq 5$ msec |
| Frequency | 47 - 63 Hz |
| Input Current (115 - 230 VAC) | 8.0 ~ 4.2 A |
| Internal fuse (factory replaceable) | 10 A |
| External Fuse (recommended) MCB curve B | 16 A |
| Output Voltage (V_n) / Nominal Current (I_n) | 24 VDC / 20A |
| Output Current I_n | 20 A |
| Efficiency (at 50% of rated current) | ≥ 91 % |
| Turn-On delay after applying input voltage | 1 sec. (max) |
| Start up with Strong Load (capacitive load) | Yes, Unlimited |
| Dissipation power load max | 48 W |
| Short-circuit protection | Yes |
| Over Load protection | Yes |
| Over Voltage Output protection | Yes (typ. 35 VDC) |
| Over Temperature protection | Yes |
| Output voltage (at I_n) | 22 ~ 28.8 VDC |
| Nominal current I_{load} | $1.1 \times I_n \pm 5\%$ |
| Continuous current (without battery) $I_{load} = I_n$ | 20 A |
| Continuous current (with battery) $I_{load} = I_n + I_{batt}$ | 40 A |
| Max. Current Output Load (Main) I_{load} (4 sec.) | 60 A max. |
| Max. Current Output Load (Back Up) I_{load} (4 sec.) | 40 A max. |
| Push Button or Remote Input Control (RTCONN cable) | Start From Battery Without Main |
| Time Buffering; min (switch output off without main input) | 0.5, 2, 5, 10, 15, 20, 30, 45, 60, ∞ ; Require SW |
| Protection alarm against total discharge | 19-20V DC battery |
| Threshold alarm for battery almost flat | 20-21 V DC battery |
| Boost charge (25 °C) (at I_n) | 28.8 VDC |
| Max. time Bust Charge | 15 h |
| Min. time Bust Charge | 1 min. |
| Trickle charge (25 °C) (at I_n) | 27.5 VDC |
| Jumper Configuration battery type (V cell) Ni-Cd (optional) | 2.23; 2.25; 2.27; 2.30; NiCd: 1.50 (20 elem.) |
| Recovery Charge | 2 ~ 16 VDC |
| Charging current max I_{batt} | 20 A $\pm 5\%$ |
| Charging current limiting I_{adj} | 10 - 100 % / I_{batt} |
| Reverse battery protection | Yes |
| Sulfated battery check | Yes by Jumper |
| Detection of element in short circuit | Yes |
| Quiescent Current | ≤ 5 mA |
| Charging Curve automatic: I_{UoUo} | 3 stage |
| Remote Input Control (RTCONN cable) | Boost / Trickle / Recovery |
| Ambient temperature (operation) | -25 - +70°C |
| De Rating $T_a > 50^\circ C$ | - 2.5%(In) / °C |
| Ambient temperature Storage | -40 - +85°C |
| Humidity at 25°C no condensation | 95% |
| Cooling | Auto convention |
| MTBF (IEC 61709) | > 300.000 h |

CBI2420A DC UPS

The Altech DC-UPS system is built to optimize power management. The available power is automatically allocated between load and battery, supplying power to the load is the first priority. For high inrush applications the charging power will reroute automatically to the load. In this case the maximum available current on the load output is two times the value of the device rated current.

The Battery Care concept based on algorithms that achieve rapid and automatic charging, battery optimization during charging time, flat batteries recovery and real time diagnostic. The Real Time Auto-diagnostic system, monitors battery faults, sulfated battery, short circuit battery elements, reverse polarity connection, battery disconnect. These conditions are detected and identified by the number of blinks of the diagnosis Led.

Signal Output Contacts

| | |
|--------------------------------------|------------------|
| Main or Backup Power | Yes |
| Battery Power Low | Yes |
| Battery Fault | Yes |
| Max. Current Rating (Resistive Load) | 1A 30 VDC/60 VAC |
| Minimum Permissible Current Rating | 1mA @ 5 VDC |

RJ45 Connection Input/Output

| | |
|---------------------------------------|----------------|
| Temp. Comp. Battery (with ext. probe) | Yes - Optional |
| Remote monitoring display | Yes - Optional |
| Can Bus | No |

Environment

| | |
|--------------------------------------|-------------------------------|
| Insulation voltage (IN/OUT) | 3000 VAC |
| Insulation voltage (input / ground) | 1605 VAC |
| Insulation voltage (Output / ground) | 500 VAC |
| Protection Class (EN/IEC 60529) | IP20 |
| Pollution Degree Environment | 2 |
| Connection TB, Screw Terminal | 4 mm ² (30-10 AWG) |
| Protection class (Ground Connected) | Class I |
| Dimensions (WxHxD) | 150x115x135 mm |
| 5.91x4.53x5.32 in | |
| Weight (approx.) | 1.55 kg (3.5 Lbs) |

Safety and EMC

| | |
|-------------------------------------|-----------------------|
| Battery charger standard compliance | IEC/EN 60335-2-29 |
| Safety standards compliance: | EN60950 / UL1950 / CE |
| Fire Detection and alarm compliance | EN54-4 |
| EMC Directive | 89/336/EEC |
| Charging cycle | DIN41773 |
| Emission | IEC 61000-6-4 |
| Immunity | IEC 61000-6-2 |

The Altech DC-UPS system is designed to charge and monitor all battery types, by selecting the battery type via jumpers. The predefined curves include Open Lead Acid, Sealed Lead Acid, Gel, Ni-Cd (optional) battery types. The charging curve are programmed to automatically switch between Recovery Charge, Boost charge and Trickle charge. The continuous battery efficiency monitoring, reduces battery damage risk and allows a safe operation in permanent connection.

A compact and rugged metal case with DIN rail mounting bracket provide an easy installation and an IP20 protection.

Jumper for Battery Type Selection

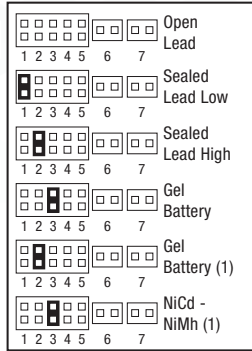

Jumper for Functional Setting

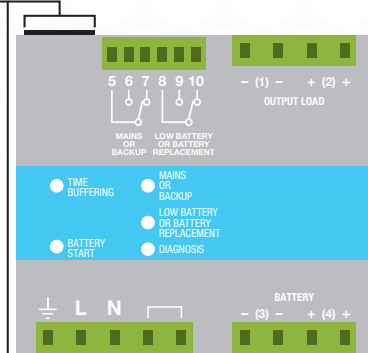
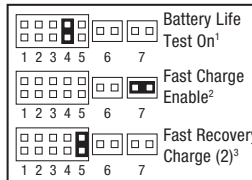

- 1 Jumper present: life test enabled.
- 2 Jumper present: fast test enabled.
- 3 Jumper present: fast recovery charge enabled only for size 3. Possibility to recharge the battery also when the voltage is close to zero with the maximum power of the device.

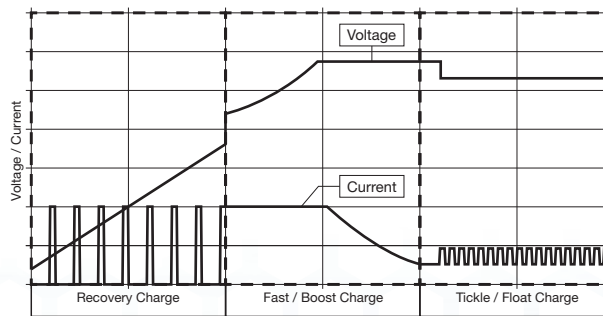
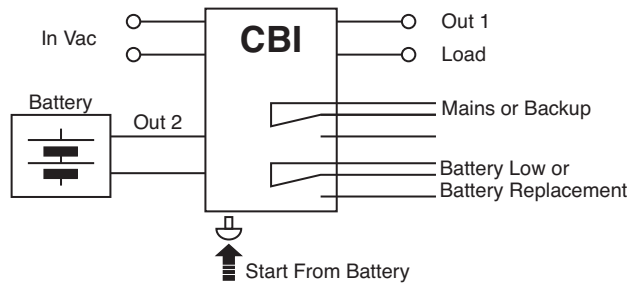

PSC Class 2 Series Compact Housing

PSA Flex Series 1 Phase

PSB Flex Series 2 & 3 Phase

PS-S Slim Series Plastic Housing

PS Low Profile Series Plastic Housing

PS Industrial Series 1, 2 & 3 Phase

PS C & W Series 1 and 2 Phase

CBI Type DC UPS Systems

CB Type Battery Chargers

Accessories

Appendix



CBI485A DC UPS



Features:

- Input: Single-phase 115 - 277 VAC
- Output Load: power supply 48VDC; 5A
- Output: Battery charging 48VDC; 5A
- Suited for the following battery types:
Open Lead Acid, Sealed Lead Acid, lead Gel and Ni-Cd (option)
- Automatic diagnostic of battery status.
- Switching technology; output voltage 44-57.6VDC
- Three charging levels: Boost, trickle and recovery
- Protection degree IP20 - DIN rail mountable

INPUT

OUTPUT

PROTECTION

LOAD OUTPUT

BATTERY OUTPUT

OTHERS

Cat. No.

CBI485A

| | |
|---|---|
| Nominal Input Voltage | 115 / 230 ~ 277 VAC |
| Voltage range | 90-135 / 180-305 VAC |
| Inrush Current ($V_n - I_n$ nom. Load). I^2t | $\leq 16 A \leq 5$ msec |
| Frequency | 47 - 63 Hz |
| Input Current (115 - 230 VAC) | 3.3 ~ 2.2 A |
| Internal fuse (factory replaceable) | 6.3 A |
| External Fuse (recommended) MCB curve B | 16 A |
| Output Voltage (V_n) / Nominal Current (I_n) | 48 VDC / 5A |
| Output Current I_n | 5 A |
| Efficiency (at 50% of rated current) | ≥ 83 % |
| Turn-On delay after applying input voltage | 1.5 sec. (max) |
| Start up with Strong Load (capacitive load) | Yes, Unlimited |
| Dissipation power load max | 28 W |
| Short-circuit protection | Yes |
| Over Load protection | Yes |
| Over Voltage Output protection | Yes (typ. 90 VDC) |
| Over Temperature protection | Yes |
| Output voltage (at I_n) | 44 ~ 57.6 VDC |
| Nominal current I_{load} | $1.1 \times I_n A \pm 5\%$ |
| Continuous current (without battery) $I_{load} = I_n$ | 5 A |
| Continuous current (with battery) $I_{load} = I_n + I_{batt}$ | 10 A |
| Max. Current Output Load (Main) I_{load} (4 sec.) | 30 A max. |
| Max. Current Output Load (Back Up) I_{load} (4 sec.) | 15 A max. |
| Push Button or Remote Input Control (RTCONN cable) | Start From Battery Without Main |
| Time Buffering; min (switch output off without main input) | ∞ ; standard 5 min.; Require SW |
| Protection alarm against total discharge | 38-40V DC battery |
| Threshold alarm for battery almost flat | 40-42V DC battery |
| Boost charge (25 °C) (at I_n) | 56.6 VDC |
| Max. time Bust Charge | 15 h |
| Min. time Bust Charge | 1 min. |
| Trickle charge (25 °C) (at I_n) | 55 VDC |
| Jumper Configuration battery type (V cell) Ni-Cd (optional) | 2.23; 2.25; 2.27; 2.30; NiCd: 1.50 (40 elem.) |
| Recovery Charge | 2 ~ 24 VDC |
| Charging current max I_{batt} | 2 A $\pm 5\%$ |
| Charging current limiting I_{adj} | 20 - 100 % / I_{batt} |
| Reverse battery protection | Yes |
| Sulfated battery check | Yes by Jumper |
| Detection of element in short circuit | Yes |
| Quiescent Current | ≤ 5 mA |
| Charging Curve automatic: I_{UoUo} | 3 stage |
| Remote Input Control (RTCONN cable) | Boost / Trickle / Recovery |
| Ambient temperature (operation) | -25 - +70°C |
| De Rating $T_a > 50^\circ C$ | - 2.5%(In) / °C |
| Ambient temperature Storage | -40 - +85°C |
| Humidity at 25°C no condensation | 95% |
| Cooling | Auto convention |
| MTBF (IEC 61709) | > 300.000 h |

CBI485A DC UPS

The Altech DC-UPS system is built to optimize power management. The available power is automatically allocated between load and battery, supplying power to the load is the first priority. For high inrush applications the charging power will reroute automatically to the load. In this case the maximum available current on the load output is two times the value of the device rated current.

The Battery Care concept based on algorithms that achieve rapid and automatic charging, battery optimization during charging time, flat batteries recovery and real time diagnostic. The Real Time Auto-diagnostic system, monitors battery faults, sulfated battery, short circuit battery elements, reverse polarity connection, battery disconnect. This conditions are detected and identified by the number of blinks of the diagnosis Led.

Signal Output Contacts

| | |
|--------------------------------------|------------------|
| Main or Backup Power | Yes |
| Battery Power Low | Yes |
| Battery Fault | Yes |
| Max. Current Rating (Resistive Load) | 1A 30 VDC/60 VAC |
| Minimum Permissible Current Rating | 1mA @ 5 VDC |

RJ45 Connection Input/Output

| | |
|---------------------------------------|----------------|
| Temp. Comp. Battery (with ext. probe) | Yes - Optional |
| Remote monitoring display | Yes - Optional |
| Can Bus | No |

Environment

| | |
|--------------------------------------|---------------------------------|
| Insulation voltage (IN/OUT) | 3000 VAC |
| Insulation voltage (input / ground) | 1605 VAC |
| Insulation voltage (Output / ground) | 500 VAC |
| Protection Class (EN/IEC 60529) | IP20 |
| Pollution Degree Environment | 2 |
| Connection TB, Screw Terminal | 2.5 mm ² (24-14 AWG) |
| Protection class (Ground Connected) | Class I |
| Dimensions (WxHxD) | 100x115x135 mm |
| 2.95x4.53x5.32 in | |
| Weight (approx.) | 0.85 kg (1.9 Lbs) |

Safety and EMC

| | |
|-------------------------------------|-----------------------|
| Battery charger standard compliance | IEC/EN 60335-2-29 |
| Safety standards compliance: | EN60950 / UL1950 / CE |
| Fire Detection and alarm compliance | EN54-4 |
| EMC Directive | 89/336/EEC |
| Charging cycle | DIN41773 |
| Emission | IEC 61000-6-4 |
| Immunity | IEC 61000-6-2 |

The Altech DC-UPS system is designed to charge and monitor all battery types, by selecting the battery type via jumpers. The predefined curves include Open Lead Acid, Sealed Lead Acid, Gel, Ni-Cd (optional) battery types. The charging curve are programmed to automatically switch between Recovery Charge, Boost charge and Trickle charge. The continuous battery efficiency monitoring, reduces battery damage risk and allows a safe operation in permanent connection.

A compact and rugged metal case with DIN rail mounting bracket provide an easy installation and an IP20 protection.

Jumper for Battery Type Selection

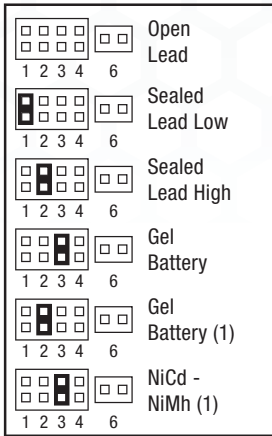

Jumper for Functional Setting

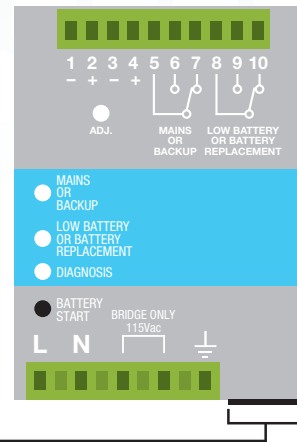
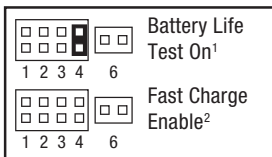

- 1 Jumper present: life test enabled.
- 2 Jumper present: fast test enabled.
- 3 Jumper present: fast recovery charge enabled only for size 3. Possibility to recharge the battery also when the voltage is close to zero with the maximum power of the device.

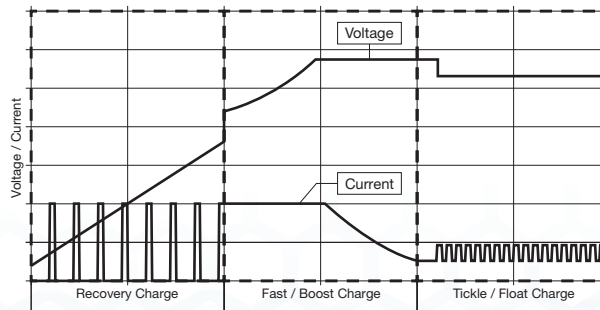

PSC Class 2 Series Compact Housing

PSA Flex Series 1 Phase

PSB Flex Series 2 & 3 Phase

PS-S Slim Series Plastic Housing

PS Low Profile Series Plastic Housing

PS Industrial Series 1, 2 & 3 Phase

PS C & W Series 1 and 2 Phase

CBI Type DC UPS Systems

CB Type Battery Chargers

Accessories

Appendix



CBI4810A DC UPS



Features:

- Input: Single-phase 115 - 277 VAC
- Output Load: power supply 48VDC; 10A
- Output: Battery charging 48VDC; 10A
- Suited for the following battery types:
Open Lead Acid, Sealed Lead Acid, lead Gel and Ni-Cd (option)
- Automatic diagnostic of battery status.
- Switching technology, output voltage 44-57.6VDC
- Three charging levels: Boost, trickle and recovery
- Protection degree IP20 - DIN rail mountable

INPUT

OUTPUT

PROTECTION

LOAD OUTPUT

BATTERY OUTPUT

OTHERS

Cat. No.

CBI4810A

| | |
|---|---|
| Nominal Input Voltage | 115 / 230 ~ 277 VAC |
| Voltage range | 90-135 / 180-305 VAC |
| Inrush Current ($V_n - I_n$ nom. Load). I^2t | $\leq 35 A \leq 5$ msec |
| Frequency | 47 - 63 Hz |
| Input Current (115 - 230 VAC) | 8.0 ~ 4.2 A |
| Internal fuse (factory replaceable) | 10 A |
| External Fuse (recommended) MCB curve B | 16 A |
| Output Voltage (V_n) / Nominal Current (I_n) | 48 VDC / 10A |
| Output Current I_n | 10 A |
| Efficiency (at 50% of rated current) | ≥ 91 % |
| Turn-On delay after applying input voltage | 1 sec. (max) |
| Start up with Strong Load (capacitive load) | Yes, Unlimited |
| Dissipation power load max | 54 W |
| Short-circuit protection | Yes |
| Over Load protection | Yes |
| Over Voltage Output protection | Yes (typ. 90 VDC) |
| Over Temperature protection | Yes |
| Output voltage (at I_n) | 44 ~ 57.6 VDC |
| Nominal current I_{load} | $1.1 \times I_n A \pm 5\%$ |
| Continuous current (without battery) $I_{load} = I_n$ | 10 A |
| Continuous current (with battery) $I_{load} = I_n + I_{batt}$ | 20 A |
| Max. Current Output Load (Main) I_{load} (4 sec.) | 30 A max. |
| Max. Current Output Load (Back Up) I_{load} (4 sec.) | 20 A max. |
| Push Button or Remote Input Control (RTCONN cable) | Start From Battery Without Main |
| Time Buffering; min (switch output off without main input) | 0.5, 1, 3, 5, 10, 15, 20, 30, 45, 60, ∞ ; Require SW |
| Protection alarm against total discharge | 38-40V DC battery |
| Threshold alarm for battery almost flat | 40-42V DC battery |
| Boost charge (25 °C) (at I_n) | 56.6 VDC |
| Max. time Bust Charge | 15 h |
| Min. time Bust Charge | 1 min. |
| Trickle charge (25 °C) (at I_n) | 55 VDC |
| Jumper Configuration battery type (V cell) Ni-Cd (optional) | 2.23; 2.25; 2.27; 2.30; NiCd: 1.50 (40 elem.) |
| Recovery Charge | 2 ~ 24 VDC |
| Charging current max I_{batt} | 10 A $\pm 5\%$ |
| Charging current limiting I_{adj} | 10 - 100 % / I_{batt} |
| Reverse battery protection | Yes |
| Sulfated battery check | Yes by Jumper |
| Detection of element in short circuit | Yes |
| Quiescent Current | ≤ 5 mA |
| Charging Curve automatic: I_{UoUo} | 3 stage |
| Remote Input Control (RTCONN cable) | Boost /Trickle / Recovery |
| Ambient temperature (operation) | -25 - +70°C |
| De Rating $T_a > 50^\circ C$ | - 2.5%(In) / °C |
| Ambient temperature Storage | -40 - +85°C |
| Humidity at 25°C no condensation | 95% |
| Cooling | Auto convection |
| MTBF (IEC 61709) | > 300.000 h |

CBI4810A DC UPS

The Altech DC-UPS system is built to optimize power management. The available power is automatically allocated between load and battery, supplying power to the load is the first priority. For high inrush applications the charging power will reroute automatically to the load. In this case the maximum available current on the load output is two times the value of the device rated current.

The Battery Care concept based on algorithms that achieve rapid and automatic charging, battery optimization during charging time, flat batteries recovery and real time diagnostic. The Real Time Auto-diagnostic system, monitors battery faults, sulfated battery, short circuit battery elements, reverse polarity connection, battery disconnect. This conditions are detected and identified by the number of blinks of the diagnosis Led.

Signal Output Contacts

| | |
|--------------------------------------|------------------|
| Main or Backup Power | Yes |
| Battery Power Low | Yes |
| Battery Fault | Yes |
| Max. Current Rating (Resistive Load) | 1A 30 VDC/60 VAC |
| Minimum Permissible Current Rating | 1mA @ 5 VDC |

RJ45 Connection Input/Output

| | |
|---------------------------------------|----------------|
| Temp. Comp. Battery (with ext. probe) | Yes - Optional |
| Remote monitoring display | Yes - Optional |
| Can Bus | Yes - Optional |

Environment

| | |
|--------------------------------------|-------------------------------|
| Insulation voltage (IN/OUT) | 3000 VAC |
| Insulation voltage (input / ground) | 1605 VAC |
| Insulation voltage (Output / ground) | 500 VAC |
| Protection Class (EN/IEC 60529) | IP20 |
| Pollution Degree Environment | 2 |
| Connection TB, Screw Terminal | 4 mm ² (30-10 AWG) |
| Protection class (Ground Connected) | Class I |
| Dimensions (WxHxD) | 150x115x135 mm |
| 5.91x4.53x5.32 in | |
| Weight (approx.) | 1.55 kg (3.5 Lbs) |

Safety and EMC

| | |
|-------------------------------------|-----------------------|
| Battery charger standard compliance | IEC/EN 60335-2-29 |
| Safety standards compliance: | EN60950 / UL1950 / CE |
| Fire Detection and alarm compliance | EN54-4 |
| EMC Directive | 89/336/EEC |
| Charging cycle | DIN41773 |
| Emission | IEC 61000-6-4 |
| Immunity | IEC 61000-6-2 |

The Altech DC-UPS system is designed to charge and monitor all battery types, by selecting the battery type via jumpers. The predefined curves include Open Lead Acid, Sealed Lead Acid, Gel, Ni-Cd (optional) battery types. The charging curve are programmed to automatically switch between Recovery Charge, Boost charge and Trickle charge. The continuous battery efficiency monitoring, reduces battery damage risk and allows a safe operation in permanent connection.

A compact and rugged metal case with DIN rail mounting bracket provide an easy installation and an IP20 protection.

Jumper for Battery Type Selection

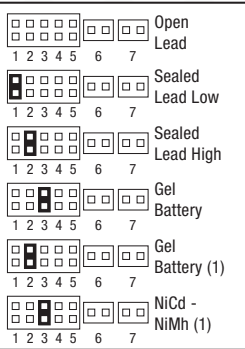

Jumper for Functional Setting

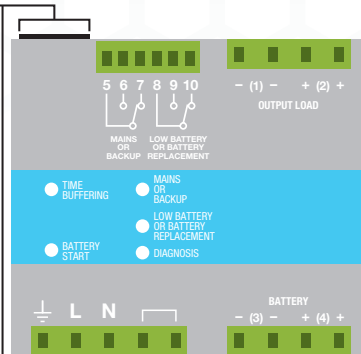
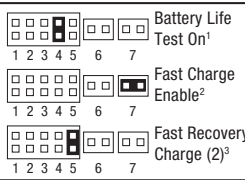

- 1 Jumper present: life test enabled.
- 2 Jumper present: fast test enabled.
- 3 Jumper present: fast recovery charge enabled only for size 3. Possibility to recharge the battery also when the voltage is close to zero with the maximum power of the device.



PSC Class 2 Series
Compact Housing

PSA Flex Series
1 Phase

PSB Flex Series
2 & 3 Phase

PS-S Slim Series
Plastic Housing

PS Low Profile Series
Plastic Housing

PS Industrial Series
1, 2 & 3 Phase

PS C & W Series
1 and 2 Phase

CBI Type
DC UPS Systems

CB Type
Battery Chargers

Accessories

Appendix



CBI2803648A DC UPS



Features:

- Input: Single-phase 115 - 277 VAC
- Output Load: power supply 36/48VDC; 7/5A
- Output: Battery charging 36/48VDC; 7/5A
- Suited for the following battery types: Open Lead Acid, Sealed Lead Acid, lead Gel and Ni-Cd (option)
- Automatic diagnostic of battery status.
- Switching technology, output voltage 33-43.2/44-57.6VDC
- Three charging levels: Boost, trickle and recovery
- Protection degree IP20 - DIN rail mountable

INPUT

OUTPUT

PROTECTION

LOAD OUTPUT

BATTERY OUTPUT

OTHERS

Cat. No.

CBI2803648A

| | |
|--|---|
| Nominal Input Voltage Voltage range Inrush Current ($V_n - I_n$ nom. Load). I ² t Frequency Input Current (115 – 230 VAC) Internal fuse (factory replaceable) External Fuse (recommended) MCB curve B | 115 ~ 230 ~ 277 VAC 90 ~ 305 VAC ≤16 A ≤ 5 msec 47 – 63 Hz 3.3 ~ 2.2 A 6.3 A 16 A |
| Output Voltage (V_n) / Nominal Power (W) Output Current I_n Efficiency (at 50% of rated current) Turn-On delay after applying input voltage Start up with Strong Load (capacitive load) Dissipation power load max | 36 / 48 VDC / 270W (jumper selection) 7 A @36VDC / 5A @48VDC ≥ 91 % 1.5 sec. (max) Yes, Unlimited 30 W |
| Short-circuit protection Over Load protection Over Voltage Output protection Over Temperature protection | Yes Yes Yes (typ. 90 VDC) Yes |
| Output voltage (at I_n) Nominal current I_{load} Continuous current (without battery) $I_{load} = I_n$ Continuous current (with battery) $I_{load} = I_n + I_{batt}$ Max. Current Output Load (Main) I_{load} (4 sec.) Max. Current Output Load (Back Up) I_{load} (4 sec.) Push Button or Remote Input Control (RTCONN cable) Time Buffering; min (switch output off without main input) Protection alarm against total discharge Threshold alarm for battery almost flat | 33 ~ 43.2 / 44 ~ 57.6 VDC 1.1 x $I_n \pm 5\%$ 7 A @ 36VDC / 5A @ 48VDC 14 A @ 36VDC / 10A @ 48VDC max. 21 A @ 36VDC / 15A @ 48VDC max. 14 A @ 36VDC / 10A @ 48VDC max. Start From Battery Without Main 0.5,2,5,10,15,20,30,45,60,∞ 26-28 / 38-40V DC battery 29-31 / 40-42V DC battery |
| Boost charge (25 °C) (at I_n) Max. time Bust Charge Min. time Bust Charge Trickle charge (25 °C) (at I_n) Jumper Configuration battery type (V cell) Ni-Cd (optional) Recovery Charge Charging current max I_{batt} Charging current limiting I_{adj} Reverse battery protection Sulfated battery check Detection of element in short circuit Quiescent Current Charging Curve automatic: I_{UoUo} Remote Input Control (RTCONN cable) | 43.2 @ 36VDC / 57.6 @ 48VDC 15 h 1 min. 41.4 @ 36VDC / 55.2 @ 48VDC 2.23; 2.25; 2.27; 2.30; NiCd: 1.50V/element 2 ~ 18 / 2 ~ 24VDC 7 A @ 36VDC / 5A @ 48VDC ± 5% 10 – 100 % / I_{batt} Yes Yes by Jumper Yes ≤ 5 mA 4 stage Boost / Trickle |
| Ambient temperature (operation) De Rating $T_a > 50^\circ\text{C}$ Ambient temperature Storage Humidity at 25°C no condensation Cooling MTBF (IEC 61709) | -25 – +70°C - 2.5%(I_n) / °C -40 – +85°C 95% Auto convection > 300.000 h |

CBI2803648A

DC UPS

The Altech DC-UPS system is built to optimize power management. The available power is automatically allocated between load and battery, supplying power to the load is the first priority. For high inrush applications the charging power will reroute automatically to the load. In this case the maximum available current on the load output is two times the value of the device rated current.

The Battery Care concept based on algorithms that achieve rapid and automatic charging, battery optimization during charging time, flat batteries recovery and real time diagnostic The Real Time Auto-diagnostic system, monitors battery faults, sulfated battery, short circuit battery elements, reverse polarity connection, battery disconnect. This conditions are detected and identified by the number of blinks of the diagnosis Led.

Signal Output Contacts

| | |
|--------------------------------------|------------------|
| Main or Backup Power | Yes |
| Battery Power Low | Yes |
| Battery Fault | Yes |
| Max. Current Rating (Resistive Load) | 1A 30 VDC/60 VAC |
| Minimum Permissible Current Rating | 1mA @ 5 VDC |

RJ45 Connection Input/Output

| | |
|---------------------------------------|----------------|
| Temp. Comp. Battery (with ext. probe) | Yes - Optional |
| Remote monitoring display | Yes - Optional |
| Can Bus | Yes - Optional |

Environment

| | |
|--------------------------------------|---------------------------------|
| Insulation voltage (IN/OUT) | 3000 VAC |
| Insulation voltage (input / ground) | 1605 VAC |
| Insulation voltage (Output / ground) | 500 VAC |
| Protection Class (EN/IEC 60529) | IP20 |
| Pollution Degree Environment | 2 |
| Connection TB, Screw Terminal | 2.5 mm ² (24-14 AWG) |
| Protection class (Ground Connected) | Class I |
| Dimensions (WxHxD) | 100x115x135 mm |
| 2.95x4.53x5.32 in | |
| Weight (approx.) | 0.85 kg (1.9 Lbs) |

Safety and EMC

| | |
|-------------------------------------|-----------------------|
| Battery charger standard compliance | IEC/EN 60335-2-29 |
| Safety standards compliance: | EN60950 / UL1950 / CE |
| Fire Detection and alarm compliance | EN54-4 |
| EMC Directive | 89/336/EEC |
| Charging cycle | DIN41773 |
| Emission | IEC 61000-6-4 |
| Immunity | IEC 61000-6-2 |

The Altech DC-UPS system is designed to charge and monitor all battery types, by selecting the battery type via jumpers. The predefined curves include Open Lead Acid, Sealed Lead Acid, Gel, Ni-Cd (optional) battery types. The charging curve are programmed to automatically switch between Recovery Charge, Boost charge and Trickle charge. The continuous battery efficiency monitoring, reduces battery damage risk and allows a safe operation in permanent connection.

A compact and rugged metal case with DIN rail mounting bracket provide an easy installation and an IP20 protection.

Jumper for Battery Type Selection



Jumper for Functional Setting



- 1 Jumper present: life test enabled.
- 2 Jumper present: fast test enabled.
- 3 Jumper present: fast recovery charge enabled only for size 3. Possibility to recharge the battery also when the voltage is close to zero with the maximum power of the device.

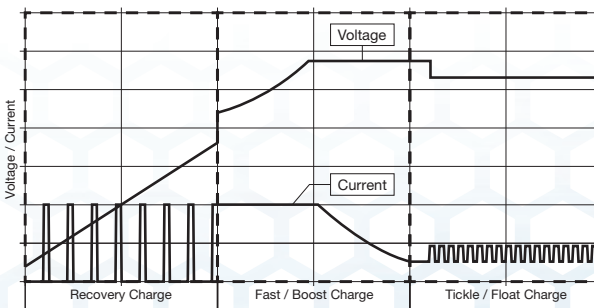
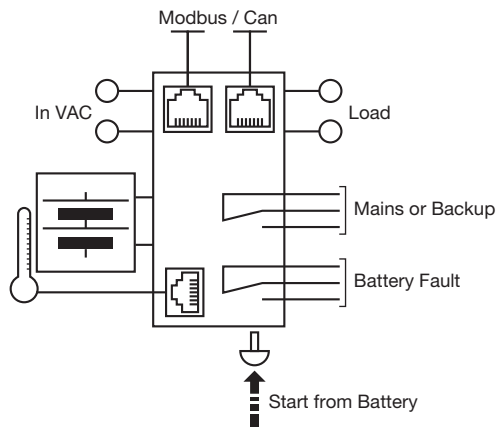

PSC Class 2 Series Compact Housing

PSA Flex Series 1 Phase

PSB Flex Series 2 & 3 Phase

PS-S Slim Series Plastic Housing

PS Low Profile Series Plastic Housing

PS Industrial Series 1, 2 & 3 Phase

PS C & W Series 1 and 2 Phase

CBI Type DC UPS Systems

CB Type Battery Chargers

Accessories

Appendix



CBI2801224A DC UPS



Features:

- Input: Single-phase 115 - 277 VAC
- Output Load: power supply 12 VDC; 15 A / 234VDC; 10A
- Output: Battery charging 12 VDC; 15 A / 24VDC; 10A
- Suited for the following battery types:
Open Lead Acid, Sealed Lead Acid, lead Gel and Ni-Cd (option)
- Automatic diagnostic of battery status.
- Switching technology, output voltage 10-14.4 VDC / 22-28.8VDC
- Three charging levels: Boost, trickle and recovery
- Protection degree IP20 - DIN rail mountable

INPUT

OUTPUT

PROTECTION

LOAD OUTPUT

BATTERY OUTPUT

OTHERS

Cat. No.

CBI2801224A

| | |
|---|---|
| Nominal Input Voltage | 115 ~ 230 ~ 277 VAC |
| Voltage range | 90 ~ 305 VAC |
| Inrush Current ($V_n - I_n$ nom. Load). I^2t | $\leq 16 A \leq 5$ msec |
| Frequency | 47 ~ 63 Hz |
| Input Current (115 ~ 230 VAC) | 3.3 ~ 2.2 A |
| Internal fuse (factory replaceable) | 6.3 A |
| External Fuse (recommended) MCB curve B | 16 A |
| Output Voltage (V_n) / Nominal Power (W) | 12 / 24 VDC / 270W (jumper selection) |
| Output Current I_n | 15 A @ 12VDC / 10A @ 24VDC |
| Efficiency (at 50% of rated current) | ≥ 91 % |
| Turn-On delay after applying input voltage | 1 sec. (max) |
| Start up with Strong Load (capacitive load) | Yes, Unlimited |
| Dissipation power load max | 28 W |
| Short-circuit protection | Yes |
| Over Load protection | Yes |
| Over Voltage Output protection | Yes (typ. 35 VDC) |
| Over Temperature protection | Yes |
| Output voltage (at I_n) | 10-14.4 / 22-28.8 VDC |
| Nominal current I_{load} | $1.1 \times I_n \pm 5\%$ |
| Continuous current (without battery) $I_{load} = I_n$ | 15 A @ 12VDC / 10A @ 24VDC |
| Continuous current (with battery) $I_{load} = I_n + I_{batt}$ | 30 A @ 12VDC / 20A @ 24VDC max. |
| Max. Current Output Load (Main) I_{load} (4 sec.) | 45 A @ 12VDC / 30A @ 24VDC max. |
| Max. Current Output Load (Back Up) I_{load} (4 sec.) | 30 A @ 12VDC / 20A @ 24VDC max. |
| Push Button or Remote Input Control (RTCONN cable) | Start From Battery Without Main |
| Time Buffering; min (switch output off without main input) | 0.5,2,5,10,15,20,30,45,60, ∞ |
| Protection alarm against total discharge | 10-11 / 20-21V DC battery |
| Threshold alarm for battery almost flat | 9-10 / 19-20V DC battery |
| Boost charge (25 °C) (at I_n) | 14.4 @ 12VDC / 28.8 @ 24VDC |
| Max. time Bust Charge | 15 h |
| Min. time Bust Charge | 1 min. |
| Trickle charge (25 °C) (at I_n) | 13.8 @ 12VDC / 27.6 @ 24VDC |
| Jumper Configuration battery type (V cell) Ni-Cd (optional) | 2.23; 2.25; 2.27; 2.30; NiCd: 1.50V / element |
| Recovery Charge | 2 ~ 18 / 2 ~ 24VDC |
| Charging current max I_{batt} | 15 A @ 12VDC / 10A @ 24VDC $\pm 5\%$ |
| Charging current limiting I_{adj} | 10 ~ 100 % / I_{batt} |
| Reverse battery protection | Yes |
| Sulfated battery check | Yes by Jumper |
| Detection of element in short circuit | Yes |
| Quiescent Current | ≤ 5 mA |
| Charging Curve automatic: I_{UoUo} | 4 stage |
| Remote Input Control (RTCONN cable) | Boost / Trickle |
| Ambient temperature (operation) | -25 ~ +70°C |
| De Rating $T_a > 50^\circ C$ | - 2.5%(In) / °C |
| Ambient temperature Storage | -40 ~ +85°C |
| Humidity at 25°C no condensation | 95% |
| Cooling | Auto convection |
| MTBF (IEC 61709) | > 300.000 h |

CBI2801224A

DC UPS

The Altech DC-UPS system is built to optimize power management. The available power is automatically allocated between load and battery, supplying power to the load is the first priority. For high inrush applications the charging power will reroute automatically to the load. In this case the maximum available current on the load output is two times the value of the device rated current.

The Battery Care concept based on algorithms that achieve rapid and automatic charging, battery optimization during charging time, flat batteries recovery and real time diagnostic. The Real Time Auto-diagnostic system, monitors battery faults, sulfated battery, short circuit battery elements, reverse polarity connection, battery disconnect. This conditions are detected and identified by the number of blinks of the diagnosis Led.

Signal Output Contacts

| | |
|--------------------------------------|------------------|
| Main or Backup Power | Yes |
| Battery Power Low | Yes |
| Battery Fault | Yes |
| Max. Current Rating (Resistive Load) | 1A 30 VDC/60 VAC |
| Minimum Permissible Current Rating | 1mA @ 5 VDC |

RJ45 Connection Input/Output

| | |
|---------------------------------------|---------------|
| Temp. Comp. Battery (with ext. probe) | Yes – (Aux 1) |
| ModBus / Can Bus | Yes – (Aux 2) |
| ModBus / Can Bus | Yes – (Aux 3) |

Environment

| | |
|--------------------------------------|---------------------------------|
| Insulation voltage (IN/OUT) | 3000 VAC |
| Insulation voltage (input / ground) | 1605 VAC |
| Insulation voltage (Output / ground) | 500 VAC |
| Protection Class (EN/IEC 60529) | IP20 |
| Pollution Degree Environment | 2 |
| Connection TB, Screw Terminal | 2.5 mm ² (24-14 AWG) |
| Protection class (Ground Connected) | Class I |
| Dimensions (WxHxD) | 100x115x135 mm |
| 2.95x4.53x5.32 in | |
| Weight (approx.) | 0.85 kg (1.9 Lbs) |

Safety and EMC

| | |
|-------------------------------------|-----------------------|
| Battery charger standard compliance | IEC/EN 60335-2-29 |
| Safety standards compliance: | EN60950 / UL1950 / CE |
| Fire Detection and alarm compliance | EN54-4 |
| EMC Directive | 89/336/EEC |
| Charging cycle | DIN41773 |
| Emission | IEC 61000-6-4 |
| Immunity | IEC 61000-6-2 |

The Altech DC-UPS system is designed to charge and monitor all battery types, by selecting the battery type via jumpers. The predefined curves include Open Lead Acid, Sealed Lead Acid, Gel, Ni-Cd (optional) battery types. The charging curve are programmed to automatically switch between Recovery Charge, Boost charge and Trickle charge. The continuous battery efficiency monitoring, reduces battery damage risk and allows a safe operation in permanent connection.

A compact and rugged metal case with DIN rail mounting bracket provide an easy installation and an IP20 protection.

Jumper for Battery Type Selection

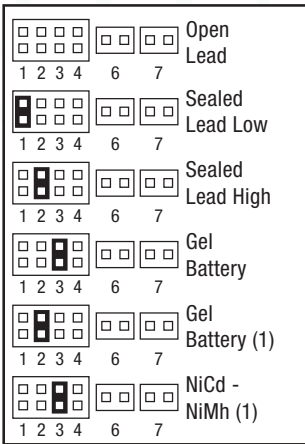

Jumper for Functional Setting

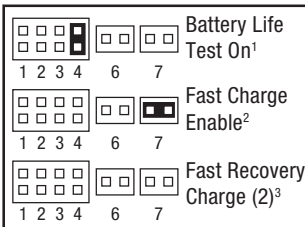

- 1 Jumper present: life test enabled.
- 2 Jumper present: fast test enabled.
- 3 Jumper present: fast recovery charge enabled only for size 3. Possibility to recharge the battery also when the voltage is close to zero with the maximum power of the device.



PSC Class 2 Series Compact Housing

PSA Flex Series 1 Phase

PSB Flex Series 2 & 3 Phase

PS-S Slim Series Plastic Housing

PS Low Profile Series Plastic Housing

PS Industrial Series 1, 2 & 3 Phase

PS C & W Series 1 and 2 Phase

CBI Type DC UPS Systems

CB Type Battery Chargers

Accessories

Appendix



CBI2801224B DC UPS



Features:

- Input: Single-phase 230 - 500 VAC
- Output Load: power supply 12 VDC; 15 A / 24VDC; 10A
- Output: Battery charging 12 VDC; 15 A / 24VDC; 10A
- Suited for the following battery types:
Open Lead Acid, Sealed Lead Acid, lead Gel and Ni-Cd (option)
- Automatic diagnostic of battery status.
- Switching technology, output voltage 10-14.4 VDC / 22-28.8 VDC
- Three charging levels: Boost, trickle and recovery
- Protection degree IP20 - DIN rail mountable

INPUT

OUTPUT

PROTECTION

LOAD OUTPUT

BATTERY OUTPUT

OTHERS

Cat. No.

CBI2801224B

| | |
|--|--|
| Nominal Input Voltage Voltage range Inrush Current ($V_n - I_n$ nom. Load). I ² t Frequency Input Current (115 - 230 VAC) Internal fuse (factory replaceable) External Fuse (recommended) MCB curve B | 230 ~ 400 ~ 500 VAC 180-264 / 330-550 VAC ≤16 A ≤ 5 msec 47 - 63 Hz 2.2 -1.4 -1.0 A 4 A 16 A |
| Output Voltage (V_n) / Nominal Power (W) Output Current I_n Efficiency (at 50% of rated current) Turn-On delay after applying input voltage Start up with Strong Load (capacitive load) Dissipation power load max | 12 / 24 VDC / 270W (jumper selection) 15 A @ 12VDC / 10A @ 24VDC ≥ 91 % 1 sec. (max) Yes, Unlimited 28 W |
| Short-circuit protection Over Load protection Over Voltage Output protection Over Temperature protection | Yes Yes Yes (typ. 35 VDC) Yes |
| Output voltage (at I_n) Nominal current I_{load} Continuous current (without battery) $I_{load} = I_n$ Continuous current (with battery) $I_{load} = I_n + I_{batt}$ Max. Current Output Load (Main) I_{load} (4 sec.) Max. Current Output Load (Back Up) I_{load} (4 sec.) Push Button or Remote Input Control (RTCONN cable) Time Buffering; min (switch output off without main input) Protection alarm against total discharge Threshold alarm for battery almost flat | 10-14.4 / 22-28.8 VDC 1.1 x $I_n \pm 5\%$ 15 A @ 12VDC / 10A @ 24VDC 30 A @ 12VDC / 20A @ 24VDC max. 45 A @ 12VDC / 30A @ 24VDC max. 30 A @ 12VDC / 20A @ 24VDC max. Start From Battery Without Main 0.5,2,5,10,15,20,30,45,60,∞ 10-11 / 20-21V DC battery 9-10 / 19-20V DC battery |
| Boost charge (25 °C) (at I_n) Max. time Bust Charge Min. time Bust Charge Trickle charge (25 °C) (at I_n) Jumper Configuration battery type (V cell) Ni-Cd (optional) Recovery Charge Charging current max I_{batt} Charging current limiting I_{adj} Reverse battery protection Sulfated battery check Detection of element in short circuit Quiescent Current Charging Curve automatic: I_{UoUo} Remote Input Control (RTCONN cable) | 14.4 @ 12VDC / 28.8 @ 24VDC 15 h 1 min. 13.8 @ 12VDC / 27.6 @ 24VDC 2.23; 2.25; 2.27; 2.30; NiCd: 1.50 / element 2 ~ 18 / 2 ~ 24VDC 15 A @ 12VDC / 10A @ 24VDC ± 5% 10 - 100 % / lbatt Yes Yes by Jumper Yes ≤ 5 mA 4 stage Boost / Trickle |
| Ambient temperature (operation) De Rating $T_a > 50^\circ\text{C}$ Ambient temperature Storage Humidity at 25°C no condensation Cooling MTBF (IEC 61709) | -25 - +70°C - 2.5%(I_n) / °C -40 - +85°C 95% Auto convention > 300.000 h |

CBI2801224B

DC UPS

The Altech DC-UPS system is built to optimize power management. The available power is automatically allocated between load and battery, supplying power to the load is the first priority. For high inrush applications the charging power will reroute automatically to the load. In this case the maximum available current on the load output is two times the value of the device rated current.

The Battery Care concept based on algorithms that achieve rapid and automatic charging, battery optimization during charging time, flat batteries recovery and real time diagnostic. The Real Time Auto-diagnostic system, monitors battery faults, sulfated battery, short circuit battery elements, reverse polarity connection, battery disconnect. This conditions are detected and identified by the number of blinks of the diagnosis Led.

Signal Output Contacts

| | |
|--------------------------------------|------------------|
| Main or Backup Power | Yes |
| Battery Power Low | Yes |
| Battery Fault | Yes |
| Max. Current Rating (Resistive Load) | 1A 30 VDC/60 VAC |
| Minimum Permissible Current Rating | 1mA @ 5 VDC |

RJ45 Connection Input/Output

| | |
|---------------------------------------|---------------|
| Temp. Comp. Battery (with ext. probe) | Yes – (Aux 1) |
| ModBus / Can Bus | Yes – (Aux 2) |
| ModBus / Can Bus | Yes – (Aux 3) |

Environment

| | |
|--------------------------------------|---------------------------------|
| Insulation voltage (IN/OUT) | 3000 VAC |
| Insulation voltage (input / ground) | 1605 VAC |
| Insulation voltage (Output / ground) | 500 VAC |
| Protection Class (EN/IEC 60529) | IP20 |
| Pollution Degree Environment | 2 |
| Connection TB, Screw Terminal | 2.5 mm ² (24-14 AWG) |
| Protection class (Ground Connected) | Class I |
| Dimensions (WxHxD) | 100x115x135 mm |
| 2.95x4.53x5.32 in | |
| Weight (approx.) | 0.85 kg (1.9 Lbs) |

Safety and EMC

| | |
|-------------------------------------|-----------------------|
| Battery charger standard compliance | IEC/EN 60335-2-29 |
| Safety standards compliance: | EN60950 / UL1950 / CE |
| Fire Detection and alarm compliance | EN54-4 |
| EMC Directive | 89/336/EEC |
| Charging cycle | DIN41773 |
| Emission | IEC 61000-6-4 |
| Immunity | IEC 61000-6-2 |

The Altech DC-UPS system is designed to charge and monitor all battery types, by selecting the battery type via jumpers. The predefined curves include Open Lead Acid, Sealed Lead Acid, Gel, Ni-Cd (optional) battery types. The charging curve are programmed to automatically switch between Recovery Charge, Boost charge and Trickle charge. The continuous battery efficiency monitoring, reduces battery damage risk and allows a safe operation in permanent connection.

A compact and rugged metal case with DIN rail mounting bracket provide an easy installation and an IP20 protection.

Jumper for Battery Type Selection



Jumper for Functional Setting



- 1 Jumper present: life test enabled.
- 2 Jumper present: fast test enabled.
- 3 Jumper present: fast recovery charge enabled only for size 3. Possibility to recharge the battery also when the voltage is close to zero with the maximum power of the device.

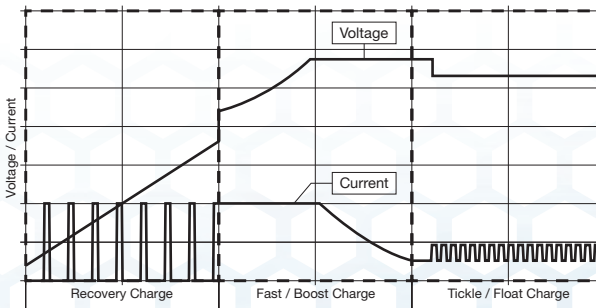

PSC Class 2 Series Compact Housing

PSA Flex Series 1 Phase

PSB Flex Series 2 & 3 Phase

PS-S Slim Series Plastic Housing

PS Low Profile Series Plastic Housing

PS Industrial Series 1, 2 & 3 Phase

PS C & W Series 1 and 2 Phase

CBI Type DC UPS Systems

CB Type Battery Chargers

Accessories

Appendix



Компания «ЭлектроПласт» предлагает заключение долгосрочных отношений при поставках импортных электронных компонентов на взаимовыгодных условиях!

Наши преимущества:

- Оперативные поставки широкого спектра электронных компонентов отечественного и импортного производства напрямую от производителей и с крупнейших мировых складов;
- Поставка более 17-ти миллионов наименований электронных компонентов;
- Поставка сложных, дефицитных, либо снятых с производства позиций;
- Оперативные сроки поставки под заказ (от 5 рабочих дней);
- Экспресс доставка в любую точку России;
- Техническая поддержка проекта, помощь в подборе аналогов, поставка прототипов;
- Система менеджмента качества сертифицирована по Международному стандарту ISO 9001;
- Лицензия ФСБ на осуществление работ с использованием сведений, составляющих государственную тайну;
- Поставка специализированных компонентов (Xilinx, Altera, Analog Devices, Intersil, Interpoint, Microsemi, Aeroflex, Peregrine, Syfer, Eurofarad, Texas Instrument, Miteq, Cobham, E2V, MA-COM, Hittite, Mini-Circuits, General Dynamics и др.);

Помимо этого, одним из направлений компании «ЭлектроПласт» является направление «Источники питания». Мы предлагаем Вам помощь Конструкторского отдела:

- Подбор оптимального решения, техническое обоснование при выборе компонента;
- Подбор аналогов;
- Консультации по применению компонента;
- Поставка образцов и прототипов;
- Техническая поддержка проекта;
- Защита от снятия компонента с производства.



Как с нами связаться

Телефон: 8 (812) 309 58 32 (многоканальный)

Факс: 8 (812) 320-02-42

Электронная почта: org@eplast1.ru

Адрес: 198099, г. Санкт-Петербург, ул. Калинина, дом 2, корпус 4, литера А.