

# General Specifications

## Electrical Capacity (Resistive Load)

**Power Level (silver):** 1A @ 125/250V AC or 1A @ 30V DC  
**Logic Level (gold):** 0.4VA maximum @ 28V AC/DC maximum (Applicable Range 0.1mA ~ 0.1A @ 20mV ~ 28V)  
 Note: Find additional explanation of operating range in Supplement section.

## Other Ratings

**Contact Resistance:** 50 milliohms maximum  
**Insulation Resistance:** 1,000 megohms minimum @ 500V DC  
**Dielectric Strength:** For Silver: 1,000V AC minimum between contacts for 1 minute minimum & 1,500V AC minimum between contacts & case for 1 minute minimum;  
 For Gold: 750V AC minimum between contacts for 1 minute minimum & 1,500V AC minimum between contacts & case for 1 minute minimum  
**Mechanical Life:** 100,000 operations minimum  
**Electrical Life:** 50,000 operations minimum for silver; 100,000 operations minimum for gold  
**Nominal Operating Force:** Single pole 0.98 ~ 2.45N for maintained & 0.98 ~ 1.96N for momentary;  
 Double pole 1.47 ~ 3.43N for maintained & 1.47 ~ 2.94N for momentary  
**Contact Timing:** Nonshorting (break-before-make)  
**Travel:** Pretravel .087" (2.2mm); Overtravel .031" (0.8mm); Total Travel .118" (3.0mm)

## Materials & Finishes

**Housing:** Polyamide (UL94V-0)  
**Movable Contactor:** Silver for power circuit; copper with gold plating for logic level circuit  
**Stationary Contacts:** Silver for power circuit; copper with gold plating for logic level circuit  
**Housing Base:** Polyamide (UL94V-0)  
**Terminal Base:** Polyester  
**Common Terminals:** Phosphor bronze with silver flash plating for power circuit;  
 Phosphor bronze with gold flash plating for logic level circuit  
**End Terminals:** Brass with silver flash plating for power circuit;  
 Brass with gold flash plating for logic level circuit  
**Lamp Terminals:** Phosphor bronze with nickel flash plating

## Environmental Data

**Operating Temperature Range:** -25°C through +50°C (-13°F through +122°F) for Illuminated  
 -25°C through +70°C (-13°F through +158°F) for Nonilluminated  
**Humidity:** 90 ~ 95% humidity for 96 hours @ 40°C (104°F)  
**Vibration:** 10 ~ 55Hz with peak-to-peak amplitude of 1.5mm traversing the frequency range & returning in 1 minute; 3 right angled directions for 2 hours  
**Shock:** 50G (490m/s<sup>2</sup>) acceleration (tested in 6 right angled directions, with 3 shocks in each direction)

## Installation

**Mounting Torque:** 0.78Nm (6.9 lb•in) maximum  
**Cap Installation Force:** 4.51N (1.0 lbf) maximum downward force on cap  
**Soldering Time & Temperature:** Manual Soldering: See Profile A in Supplement section.

## Standards & Certifications

**Flammability Standards:** UL94V-0 housing & housing base  
**UL:** **File No. E44145 - Recognized only when ordered with marking on switch.**  
 Add "/U" or "/CUL" before first dash in part number to order UL recognized switch.  
 Single & double pole models recognized at 1A @ 125/250V AC, 1A @ 30V DC, & 0.4VA @ 28V DC.  
**CSA:** **File No. 023535\_0\_000 - Certified only when ordered with marking on switch.**  
 Add "/C" before first dash in part number to order CSA certified switch.  
 Single & double pole models recognized at 1A @ 125/250V AC, 1A @ 30V DC, & 0.4VA @ 28V DC.

# Distinctive Characteristics

Bright illumination with numerous color variations. Spot illumination available. Square, rectangular, and round shaped caps.

Front panel relamping.

Choice of bright or super bright LEDs in red, amber, green, white, and blue.

Latchdown feature gives indication of circuit status. Audible and tactile feedback with smooth and responsive operation.

Snap-action mechanism for long life.

Stainless steel frame on snap-in models has a specially designed projection, which prevents rotation and correctly orients switch in panel.

12mm body diameter.

Molded-in terminals lock out flux, dust, and other contaminants.

8mm panel thickness capability. Rear panel bushing or snap-in mounting.

Optional PCB adaptors in straight and right angle types.

Matching indicators available.



Actual Size



### TYPICAL SWITCH



#### IMPORTANT:



Switches are supplied without UL, cULus & CSA marking unless specified.  
**UL, cULus & CSA recognized only when ordered with marking on the switch.**  
 Specific models, ratings, & ordering instructions are noted on the General Specifications page.

#### DESCRIPTION FOR TYPICAL ORDERING EXAMPLE

#### KB15CKW01-12-FF



## ORDERING EXAMPLE

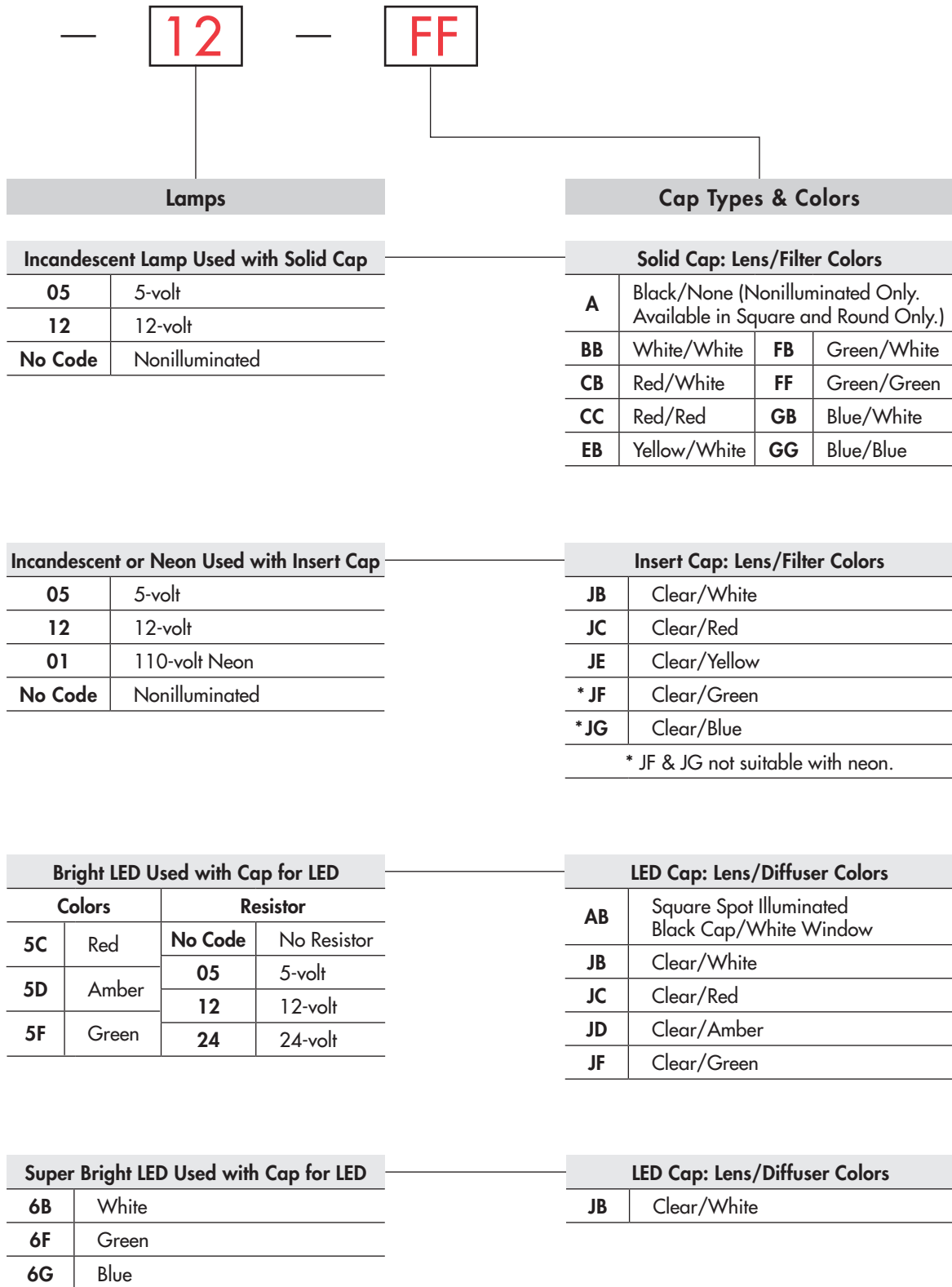

Toggle

Rockers

Pushbuttons

Illuminated PB

Programmable

Keylocks

Rotaries

Slides

Tactiles

Tilt

Touch

Indicators

Accessories

Supplement

## POLES & CIRCUITS

Pole	Model	Plunger Position ( ) = Momentary		Connected Terminals		Throw & Switch/Lamp Schematics
		Normal	Down	Normal	Down	
SP	KB15 *KB16	ON ON	(ON) ON	2-3	2-1	Notes: Switch is marked with "+" and "-". Lamp circuit is isolated and requires external power source. SPDT
DP	KB25 *KB26	ON ON	(ON) ON	2-3 5-6	2-1 5-4	DPDT

\* When in latchdown position for the alternate circuit, cap position is .055" (1.4mm) above the built-in bezel.

## MOUNTING TYPES & SHAPES

### Bushing Mounting

**S** .551" (14.0mm)  
Square



No barrier



With barrier

**C** .551" (14.0mm)  
Round



**R** .551" x .728" (14.0mm x 18.5mm)  
Rectangular



No barrier

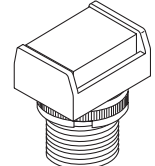

With barrier

Bezel or barrier is an integral part of the switch body. One mounting nut AT057 supplied with each switch.

### Snap-in Mounting

**K** .551" (14.0mm)  
Square



No barrier



With barrier

**M** .551" (14.0mm)  
Round

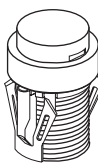

**N** .551" x .728" (14.0mm x 18.5mm)  
Rectangular



No barrier

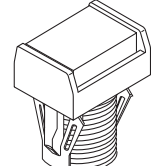

With barrier

Bezel or barrier is an integral part of the switch body.

### Panel Cutouts

#### Bushing Mounting

Without Keyway



Panel Thickness:  
.020" ~ .315"  
(0.5 ~ 8.0mm)



With Keyway

#### Snap-in Mounting

Panel Thickness:  
.039" ~ .138"  
(1.0 ~ 3.5mm)



Panel thicknesses, when using optional accessories, are shown with the accessories at the end of this KB section.

## HOUSING

**K** Housing available in black only. Bezel or barrier is an integral part of the switch body.

## CONTACT MATERIALS, RATINGS & TERMINALS

**W** Silver Contacts

**Power Level**  
1A @ 125V AC & 250V AC

**01** Solder Lug



**G** Gold Contacts

**Logic Level**  
0.4VA maximum @ 28V AC/DC

Complete explanation of operating range in Supplement section.

### AT055 Crossover Guard

A partitioned plastic guard is supplied with each switch to provide insulation between terminals.

Installation steps:

1. Identify wire-to-terminal connections.
2. Thread wires through the guard.
3. Solder the connections.
4. Push the guard fully onto the switch body.



## BARRIER TYPE

**No Code** No Barrier  
Built-in bezel

**B** With Barrier  
Built-in barrier only available for Square and Rectangular

## LAMP COLORS & SPECIFICATIONS

The electrical specifications shown are determined at a basic temperature of 25°C. LED circuit is isolated and requires external power source. Polarity marks are on the bottom of the switch. If the source voltage exceeds the rated voltage, a ballast resistor is required. The resistor value can be calculated by using the formula in the Supplement section. Ambient Temperature Range for lamps below: -25°C ~ +50°C.

### Incandescent & Neon Lamps

		<b>05</b>	<b>12</b>	<b>01</b>			
<b>AT611</b> Incandescent	<b>AT615</b> Neon				Recommended Resistors for Neon: 33K ohms for 110V AC; 100K ohms for 220V AC		
		Voltage	V	5V AC		12V AC	110V AC
		Current	I	115mA		60mA	1.5mA
		Endurance	Hours	7,000 average		10,000	

**No Code** No Lamp

### Bright LED with Resistor

<b>AT634</b>	Color Codes:			Resistor Codes		
	Red	Amber	Green			
LEDs are colored in OFF state.	<b>5C</b>	<b>5D</b>	<b>5F</b>	<b>05</b>	<b>12</b>	<b>24</b>
	Maximum Forward Current			$I_{FM}$	—	—
	Typical Forward Current			$I_F$	25mA	20mA
	Forward Voltage			$V_F$	5V	12V
	Maximum Reverse Voltage			$V_{RM}$	4V	8V
	Current Reduction Rate Above 25°C			$\Delta I_F$	—	—

AT634  
5-volt  
2-element  
with 1 Resistor

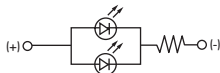

AT634  
12-volt  
4-element  
with 2 Resistors

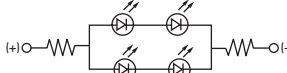

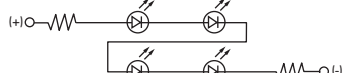

AT634  
24-volt  
4-element  
with 2 Resistors





## LAMP COLORS & SPECIFICATIONS

### Bright LED without Resistor

<b>AT635</b> LEDs are colored in OFF state.   T-1½ Bi-pin	Color Codes	Red <b>5C</b>	Amber <b>5D</b>	Green <b>5F</b>	<b>No Code</b> No Resistor	Red	Amber	Green
	Maximum Forward Current				$I_{FM}$	30mA	30mA	30mA
	Typical Forward Current				$I_F$	20mA	20mA	20mA
	Forward Voltage				$V_F$	1.9V	2.0V	2.1V
	Maximum Reverse Voltage				$V_{RM}$	5V	5V	5V
	Current Reduction Rate Above 25°C				$\Delta I_F$	0.42mA/°C		
	Ambient Temperature Range					-25° ~ +50°C		

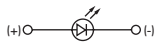
### Super Bright Single Element LED

<b>AT625G Blue</b> <b>AT631B White</b> <b>AT632F Green</b>   T-1 Bi-pin	 <b>ATTENTION</b> ELECTROSTATIC SENSITIVE DEVICES			Color	<b>6B</b>	<b>6F</b>	<b>6G</b>	
	Maximum Forward Current				$I_{FM}$	30mA	30mA	30mA
	Typical Forward Current				$I_F$	20mA	20mA	20mA
	Forward Voltage				$V_F$	3.6V	3.3V	3.3V
	Maximum Reverse Voltage				$V_{RM}$	5V	7V	7V
	Current Reduction Rate Above 25°C				$\Delta I_F$	0.50mA/°C	0.40mA/°C	0.40mA/°C
	Ambient Temperature Range					-25° ~ +50°C		

## CAP TYPES & COLOR COMBINATIONS

Color Codes:    **A** Black    **B** White    **C** Red    **E** Yellow    **F** Green    **G** Blue    **J** Clear

### Solid Cap for Incandescent Lamp & Nonilluminated

Lens/Filter Colors Available:

- A** Nonilluminated Only; Square & Round Only
- BB**    **FB**
- CB**    **FF**
- CC**    **GB**
- EB**    **GG**

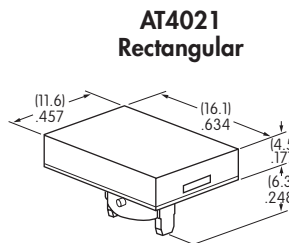

Material: Polycarbonate    Finish: Glossy



### Insert Cap for Incandescent or Neon Lamp & Nonilluminated

Lens/Filter Colors Available:

- JB**    **JF**
- JC**    **JG**
- JE**

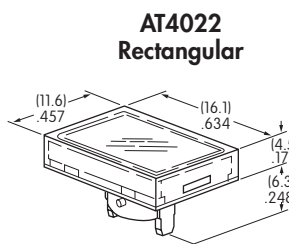
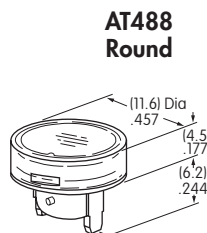

Material: Polycarbonate    Finish: Glossy



JF and JG not suitable with neon lamp.

Toggles, Rockers, Pushbuttons, Illuminated PB, Programmable, Keylocks, Rotaries, Slides, Tactiles, Tilt, Touch, Indicators, Accessories, Supplement

## CAP TYPES & COLOR COMBINATIONS

Color Codes: A Black B White C Red D Amber E Yellow F Green G Blue J Clear

### Spot Illuminated Cap for Bright LED without Resistor or with Resistor

Cap/Window Colors Available:

**AB**

Opaque Black Cap with Translucent White Window for Spot Illumination

**AT4051**  
Square



Bright LED  
AT635

Bright LED  
AT634

Material: Polycarbonate Finish: Matte

### Cap for Bright LED without Resistor or LED with Resistor

Lens/Diffuser Colors Available: (AT4133, 4132, 4134 white diffusers; AT4158, 4160, 4159 colored diffusers)

**JB**

**AT4133**

**AT4132**

**AT4134**



Square

Round

Rectangular

Transparent Clear Lens

**JC**

**AT4158**

**AT4160**

**AT4159**

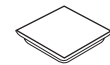

**JD**

**JF**

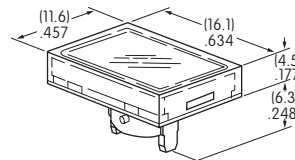
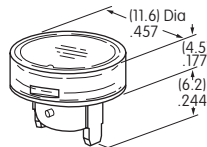
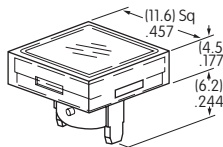

Translucent Diffuser



Bright LED  
AT635

Bright LED  
AT634

Material: Polycarbonate Finish: Glossy

### Cap for Super Bright LED

Lens/Diffuser Colors Available:

**JB**

**AT4133**  
Square

**AT4132**  
Round

**AT4134**  
Rectangular



Translucent Clear Lens

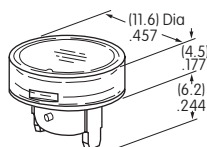
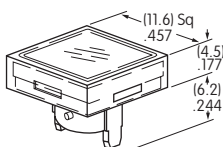

Translucent White Diffuser



Super Bright LEDs  
AT625  
AT631 AT632

Material: Polycarbonate Finish: Glossy



## TYPICAL SWITCH DIMENSIONS

### Square • Bushing Mount

### Single & Double Pole

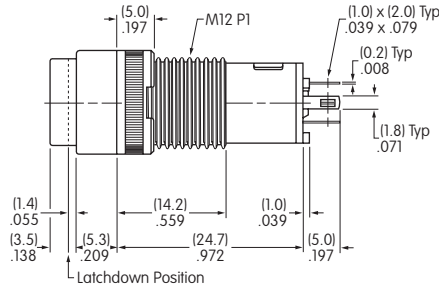
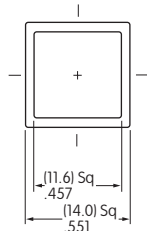

**KB15SKW01-05-GG**

Single pole models do not have terminals 4, 5, & 6.

### Round • Bushing Mount

### Single & Double Pole

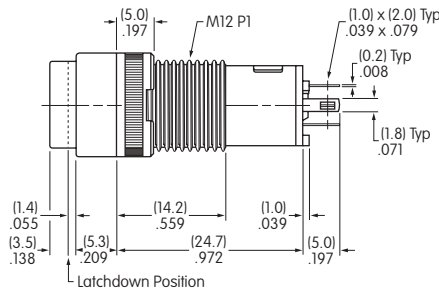
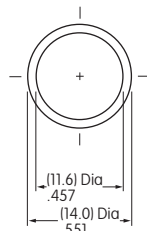

**KB25CKW01-05-GG**

Single pole models do not have terminals 4, 5, & 6.

### Rectangular • Bushing Mount

### Single & Double Pole

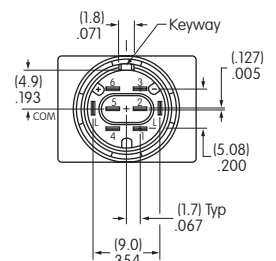
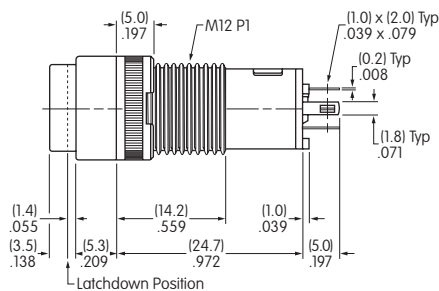
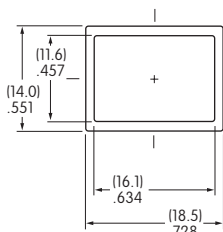

**KB15RKW01-05-GG**

Single pole models do not have terminals 4, 5, & 6.

TYPICAL SWITCH DIMENSIONS

Single & Double Pole

Square • Snap-in Mount

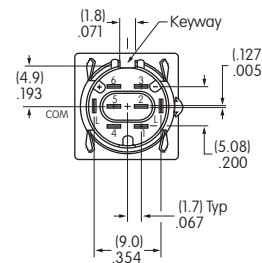

Single pole models do not have terminals 4, 5, & 6.

KB16KKW01-05-CB

Single & Double Pole

Round • Snap-in Mount

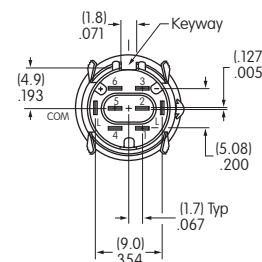

Single pole models do not have terminals 4, 5, & 6.

KB26MKW01-05-CB

Single & Double Pole

Rectangular • Snap-in Mount

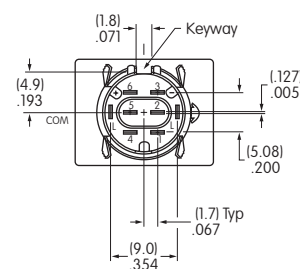

Single pole models do not have terminals 4, 5, & 6.

KB16NKW01-05-CB

## TYPICAL SWITCH DIMENSIONS

### Square • Barrier • Bushing Mount

### Single & Double Pole

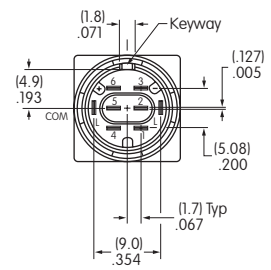

**KB15SKW01B-6G-JB**

Single pole models do not have terminals 4, 5, & 6.

### Square • Barrier • Snap-in Mount

### Single & Double Pole

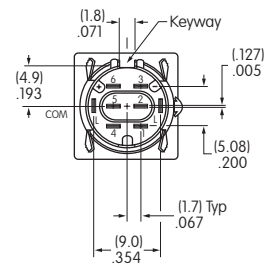
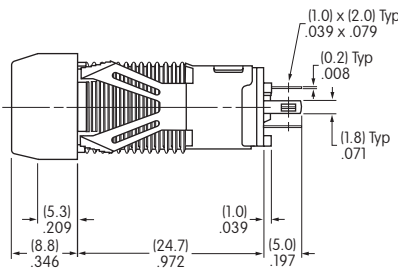

**KB15KKW01B-5C-JC**

Single pole models do not have terminals 4, 5, & 6.

### Rectangular • Barrier • Bushing Mount

### Single & Double Pole

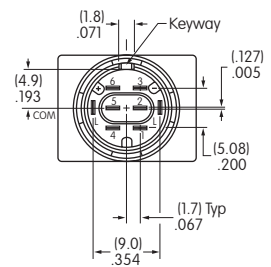
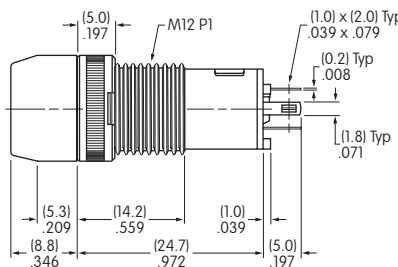
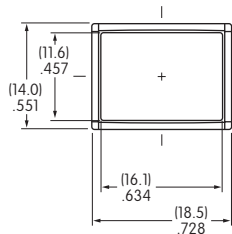

**KB15RKW01B-5F-JF**

Single pole models do not have terminals 4, 5, & 6.

### Rectangular • Barrier • Snap-in Mount

### Single & Double Pole

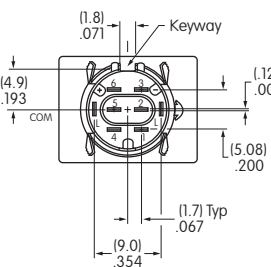
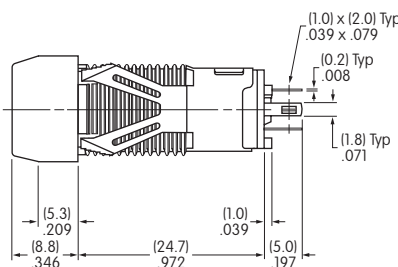
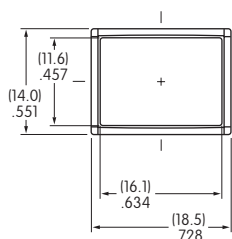

**KB15NKW01B-5D-JD**

Single pole models do not have terminals 4, 5, & 6.

## OPTIONAL ACCESSORIES

### PCB Adaptors

**AT701**  
Single Pole  
Straight PC  
Terminals



**AT702**  
Double Pole  
Straight PC  
Terminals



Material: Glass fiber reinforced polyamide Note: Order adaptors separately

### Dust Covers

Panel Thickness Range: .020 ~ .268" (0.5 ~ 6.8mm) for Bushing Mounting; .020 ~ .079" (0.5 ~ 2.0mm) for Snap-in Mounting  
Dust Covers reduce the depth of switch behind panel by .047" (1.2mm).

**AT495**  
For Square & Round  
(not for Barrier type)

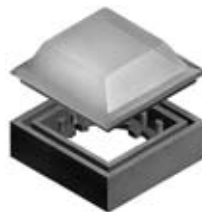

**AT4025**  
For Rectangular  
(not for Barrier type)



Material: Lid: PVC PVC loses pliability below 0°C (32°F). Base: Polyamide

- Toggle
- Rockers
- Pushbuttons
- illuminated PB**
- Programmable
- Keylocks
- Rotaries
- Slides
- Tactiles
- Tilt
- Touch
- Indicators
- Accessories
- Supplement

## OPTIONAL ACCESSORIES

### Protective Guards

**AT494**  
For Square & Round  
(not for Barrier type)



**AT4024**  
For Rectangular  
(not for Barrier type)



Panel Thickness  
Range:

.020" ~ .268"  
(0.5 ~ 6.8mm)  
for Bushing Mounting

.020" ~ .091"  
(0.5 ~ 2.3mm)  
for Snap-in Mounting

Protective Guards reduce  
the depth of switch  
behind panel by  
.047" (1.2mm).



Material: Cover: Polycarbonate

Base: Polyamide

## ASSEMBLY INSTRUCTIONS

### Cap Removal & Installation

For alternate action models cap must be in UP position for cap removal. Indentations on opposite sides of the cap provide an easy way to lift the cap out of the holder, using either the finger nails, or cap extractor AT109.

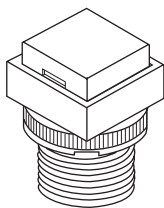

### LED Polarity & Orientation in Lamp Socket

Super Bright LEDs AT625, AT631, & AT632 are electrostatic sensitive.



LED  
AT635



LED  
AT634



LEDs  
AT625  
AT631  
AT632



### Cap Replacement

Note that the cap has a pair of round tabs and a pair of long tabs which should be used for correctly replacing the cap in its holder. Using the long tabs as guides, slide the cap with the long tabs moving into the slots on opposite sides of the cap holder. Then, the round tabs will snap into notches on the other two sides of the holder.

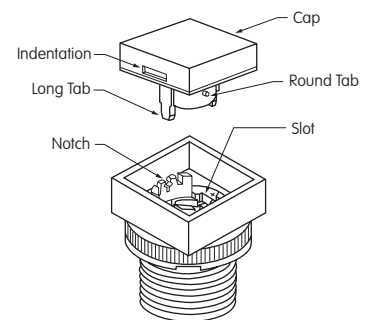

### AT108 Socket Wrench for Bushing Mounting

Overtightening the mounting nut may damage the switch housing.



### AT109 Cap Extractor



### AT111 Lamping Tool



LEGENDS

NKK Switches can provide custom legends for caps. Contact factory for more information.

Suggested Printable Area for KB Lens

**Recommended Methods:** Screen Print or Pad Print on Lens.  
Epoxy based ink is recommended.



Shaded areas are printable areas.

Suggested Printable Area for Film Insert

**Recommended Print Method:** Laser Print

Film Insert: Clear Polyester, 4 mil max. thickness

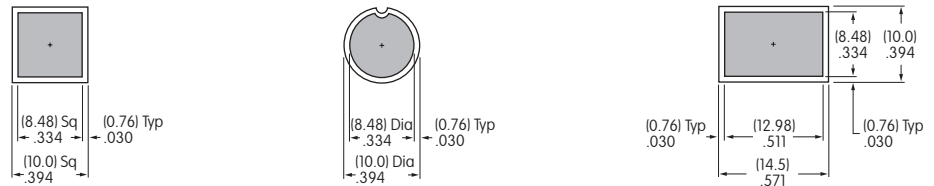
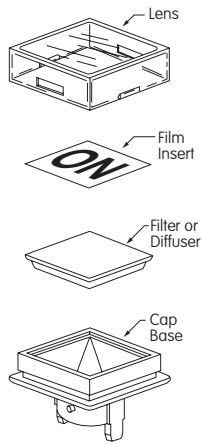

Shaded areas are printable areas.



Компания «ЭлектроПласт» предлагает заключение долгосрочных отношений при поставках импортных электронных компонентов на взаимовыгодных условиях!

Наши преимущества:

- Оперативные поставки широкого спектра электронных компонентов отечественного и импортного производства напрямую от производителей и с крупнейших мировых складов;
- Поставка более 17-ти миллионов наименований электронных компонентов;
- Поставка сложных, дефицитных, либо снятых с производства позиций;
- Оперативные сроки поставки под заказ (от 5 рабочих дней);
- Экспресс доставка в любую точку России;
- Техническая поддержка проекта, помощь в подборе аналогов, поставка прототипов;
- Система менеджмента качества сертифицирована по Международному стандарту ISO 9001;
- Лицензия ФСБ на осуществление работ с использованием сведений, составляющих государственную тайну;
- Поставка специализированных компонентов (Xilinx, Altera, Analog Devices, Intersil, Interpoint, Microsemi, Aeroflex, Peregrine, Syfer, Eurofarad, Texas Instrument, Miteq, Cobham, E2V, MA-COM, Hittite, Mini-Circuits, General Dynamics и др.);

Помимо этого, одним из направлений компании «ЭлектроПласт» является направление «Источники питания». Мы предлагаем Вам помощь Конструкторского отдела:

- Подбор оптимального решения, техническое обоснование при выборе компонента;
- Подбор аналогов;
- Консультации по применению компонента;
- Поставка образцов и прототипов;
- Техническая поддержка проекта;
- Защита от снятия компонента с производства.



#### Как с нами связаться

**Телефон:** 8 (812) 309 58 32 (многоканальный)

**Факс:** 8 (812) 320-02-42

**Электронная почта:** [org@eplast1.ru](mailto:org@eplast1.ru)

**Адрес:** 198099, г. Санкт-Петербург, ул. Калинина, дом 2, корпус 4, литера А.