

### Features

- Very high frequency operation
- Low  $C_{RES} / C_{IES}$  ratio (no cross-conduction susceptibility)
- Very soft ultra fast recovery antiparallel diode

### Applications

- Very high frequency inverters, UPS
- HF, SMPS and PFC in both hard switch and resonant topologies
- Motor drivers
- Welding

### Description

This IGBT utilizes the advanced Power MESH™ process resulting in an excellent trade-off between switching performance and low on-state behavior.

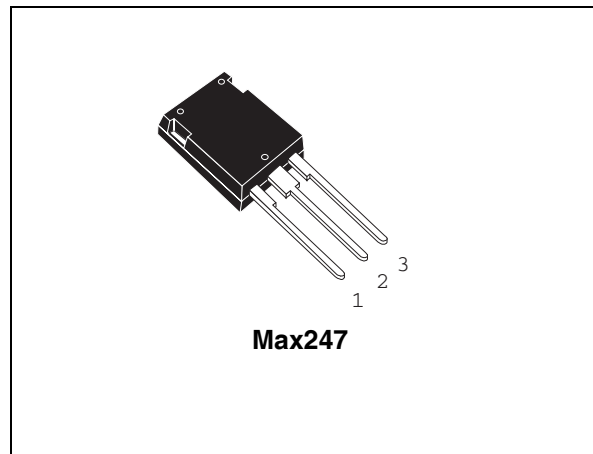

**Figure 1. Internal schematic diagram**

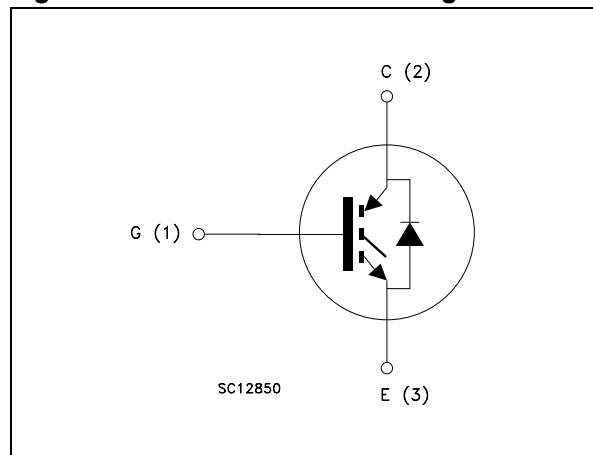

**Table 1. Device summary**

Order code	Marking	Package	Packaging
STGY50NC60WD	GY50NC60WD	Max247	Tube

## Contents

<b>1</b>	<b>Electrical ratings</b> .....	<b>3</b>
<b>2</b>	<b>Electrical characteristics</b> .....	<b>4</b>
	2.1 Electrical characteristics (curves) .....	7
<b>3</b>	<b>Test circuit</b> .....	<b>10</b>
<b>4</b>	<b>Package mechanical data</b> .....	<b>11</b>
<b>5</b>	<b>Revision history</b> .....	<b>13</b>

# 1 Electrical ratings

**Table 1. Absolute maximum ratings**

Symbol	Parameter	Value	Unit
$V_{CES}$	Collector-emitter voltage ( $V_{GE} = 0$ )	600	V
$I_C^{(1)}$	Collector current (continuous) at $T_C = 25\text{ °C}$	110	A
$I_C^{(1)}$	Collector current (continuous) at $T_C = 100\text{ °C}$	50	A
$I_{CL}^{(2)}$	Turn-off latching current	180	A
$I_{CP}^{(3)}$	Pulsed collector current	180	A
$I_F$	Diode RMS forward current at $T_C = 25\text{ °C}$	30	A
$I_{FSM}$	Surge not repetitive forward current ( $t_p=10\text{ ms}$ sinusoidal)	120	A
$V_{GE}$	Gate-emitter voltage	$\pm 20$	V
$P_{TOT}$	Total dissipation at $T_C = 25\text{ °C}$	278	W
$T_j$	Operating junction temperature	-55 to 150	$^{\circ}\text{C}$

1. Calculated according to the iterative formula:

$$I_C(T_C) = \frac{T_{j(max)} - T_C}{R_{thj-c} \times V_{CE(sat)(max)}(T_{j(max)}, I_C(T_C))}$$

2.  $V_{clamp} = 80\%$  of  $V_{CES}$ ,  $T_j = 150\text{ °C}$ ,  $R_G = 10\ \Omega$ ,  $V_{GE} = 15\text{ V}$

3. Pulse width limited by max. temperature allowed

**Table 2. Thermal resistance**

Symbol	Parameter	Value	Unit
$R_{thj-case}$	Thermal resistance junction-case IGBT max.	0.45	$^{\circ}\text{C/W}$
$R_{thj-case}$	Thermal resistance junction-case diode max.	1.5	$^{\circ}\text{C/W}$
$R_{thj-amb}$	Thermal resistance junction-ambient max.	50	$^{\circ}\text{C/W}$

## 2 Electrical characteristics

( $T_{CASE} = 25\text{ °C}$  unless otherwise specified)

**Table 3. Static**

Symbol	Parameter	Test conditions	Min.	Typ.	Max.	Unit
$V_{(BR)CES}$	Collector-emitter breakdown voltage ( $V_{GE} = 0$ )	$I_C = 1\text{ mA}$	600			V
$V_{CE(sat)}$	Collector-emitter saturation voltage	$V_{GE} = 15\text{ V}, I_C = 40\text{ A}$ $V_{GE} = 15\text{ V}, I_C = 40\text{ A}, T_C = 125\text{ °C}$		2.1 1.9	2.6	V V
$V_{GE(th)}$	Gate threshold voltage	$V_{CE} = V_{GE}, I_C = 250\text{ }\mu\text{A}$	3.75		5.75	V
$I_{CES}$	Collector cut-off current ( $V_{GE} = 0$ )	$V_{CE} = 600\text{ V}$ $V_{CE} = 600\text{ V}, T_C = 125\text{ °C}$			500 5	$\mu\text{A}$ mA
$I_{GES}$	Gate-emitter leakage current ( $V_{CE} = 0$ )	$V_{GE} = \pm 20\text{ V}$			$\pm 100$	nA
$g_{fs}$	Forward transconductance	$V_{CE} = 15\text{ V}, I_C = 40\text{ A}$		25		S

**Table 4. Dynamic**

Symbol	Parameter	Test conditions	Min.	Typ.	Max.	Unit
$C_{ies}$	Input capacitance	$V_{CE} = 25\text{ V}, f = 1\text{ MHz},$ $V_{GE} = 0$		4700		pF
$C_{oes}$	Output capacitance			410		pF
$C_{res}$	Reverse transfer capacitance			90		pF
$Q_g$	Total gate charge	$V_{CE} = 390\text{ V}, I_C = 40\text{ A},$		195		nC
$Q_{ge}$	Gate-emitter charge	$V_{GE} = 15\text{ V},$		32		nC
$Q_{gc}$	Gate-collector charge	<a href="#">Figure 16</a>		82		nC

**Table 5. Switching on/off (inductive load)**

Symbol	Parameter	Test conditions	Min.	Typ.	Max.	Unit
$t_{d(on)}$ $t_r$ $(di/dt)_{on}$	Turn-on delay time Current rise time Turn-on current slope	$V_{CC} = 390\text{ V}$ , $I_C = 40\text{ A}$ $R_G = 10\ \Omega$ , $V_{GE} = 15\text{ V}$ , <i>Figure 17, Figure 15</i>		52 17 2400		ns ns A/ $\mu$ s
$t_{d(on)}$ $t_r$ $(di/dt)_{on}$	Turn-on delay time Current rise time Turn-on current slope	$V_{CC} = 390\text{ V}$ , $I_C = 40\text{ A}$ $R_G = 10\ \Omega$ , $V_{GE} = 15\text{ V}$ , $T_C = 125\text{ }^\circ\text{C}$ <i>Figure 17, Figure 15</i>		50 19 2020		ns ns A/ $\mu$ s
$t_{r(Voff)}$ $t_{d(Voff)}$ $t_f$	Off voltage rise time Turn-off delay time Current fall time	$V_{CC} = 390\text{ V}$ , $I_C = 40\text{ A}$ $R_G = 10\ \Omega$ , $V_{GE} = 15\text{ V}$ , <i>Figure 17, Figure 15</i>		31 240 35		ns ns ns
$t_{r(Voff)}$ $t_{d(Voff)}$ $t_f$	Off voltage rise time Turn-off delay time Current fall time	$V_{CC} = 390\text{ V}$ , $I_C = 40\text{ A}$ $R_G = 10\ \Omega$ , $V_{GE} = 15\text{ V}$ , $T_C = 125\text{ }^\circ\text{C}$ <i>Figure 17, Figure 15</i>		59 280 63		ns ns ns

**Table 6. Switching energy (inductive load)**

Symbol	Parameter	Test conditions	Min.	Typ.	Max.	Unit
$E_{on}^{(1)}$ $E_{off}^{(2)}$ $E_{ts}$	Turn-on switching losses Turn-off switching losses Total switching losses	$V_{CC} = 390\text{ V}$ , $I_C = 40\text{ A}$ $R_G = 10\ \Omega$ , $V_{GE} = 15\text{ V}$ , <i>Figure 15</i>		365 560 925	470 790 1260	$\mu$ J $\mu$ J $\mu$ J
$E_{on}^{(1)}$ $E_{off}^{(2)}$ $E_{ts}$	Turn-on switching losses Turn-off switching losses Total switching losses	$V_{CC} = 390\text{ V}$ , $I_C = 40\text{ A}$ $R_G = 10\ \Omega$ , $V_{GE} = 15\text{ V}$ , $T_C = 125\text{ }^\circ\text{C}$ <i>Figure 15</i>		635 910 1545		$\mu$ J $\mu$ J $\mu$ J

1.  $E_{on}$  is the turn-on losses when a typical diode is used in the test circuit in *Figure 18*. If the IGBT is offered in a package with a co-pack diode, the co-pack diode is used as external diode. IGBTs & Diode are at the same temperature (25°C and 125°C)
2. Turn-off losses include also the tail of the collector current

Table 7. Collector-emitter diode

Symbol	Parameter	Test conditions	Min.	Typ.	Max.	Unit
$V_F$	Forward on-voltage	$I_F = 40 \text{ A}$		3.2		V
		$I_F = 40 \text{ A}, T_C = 125 \text{ }^\circ\text{C}$		2.2		V
$t_{rr}$	Reverse recovery time	$I_F = 40 \text{ A}, V_R = 50 \text{ V},$ $di/dt = 100 \text{ A}/\mu\text{s}$		55		ns
$Q_{rr}$	Reverse recovery charge	$di/dt = 100 \text{ A}/\mu\text{s}$		100		nC
$I_{rrm}$	Reverse recovery current	<i>Figure 18</i>		3.6		A
$t_{rr}$	Reverse recovery time	$I_F = 40 \text{ A}, V_R = 50 \text{ V},$ $T_C = 125 \text{ }^\circ\text{C},$ $di/dt = 100 \text{ A}/\mu\text{s}$ ( <i>Figure 18</i> )		164		ns
$Q_{rr}$	Reverse recovery charge	$T_C = 125 \text{ }^\circ\text{C},$ $di/dt = 100 \text{ A}/\mu\text{s}$ ( <i>Figure 18</i> )		525		nC
$I_{rrm}$	Reverse recovery current	$di/dt = 100 \text{ A}/\mu\text{s}$ ( <i>Figure 18</i> )		6.4		A

## 2.1 Electrical characteristics (curves)

Figure 1. Output characteristics

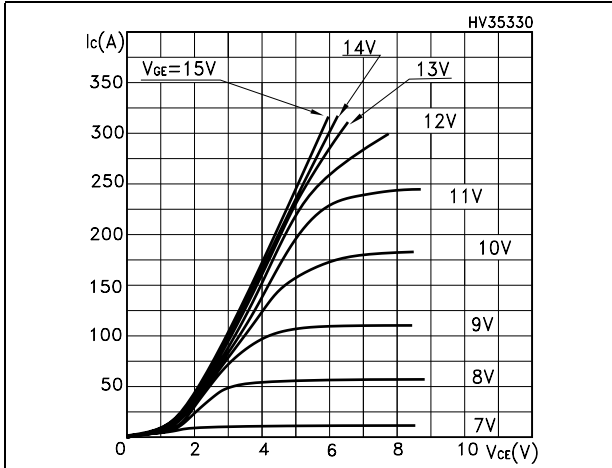

Figure 2. Transfer characteristics

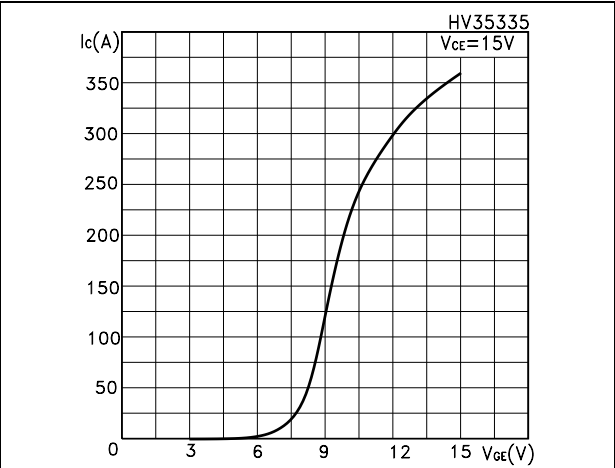

Figure 3. Transconductance

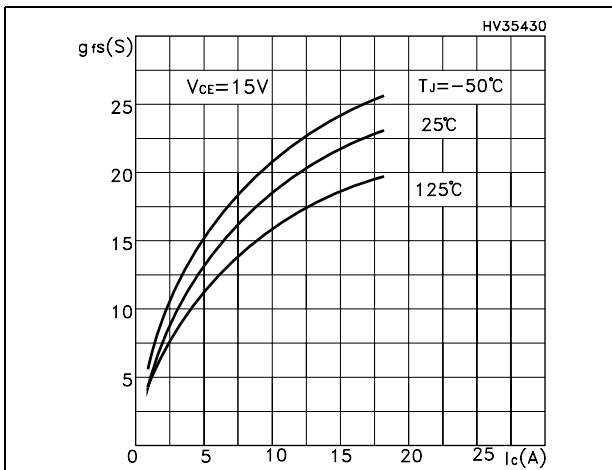

Figure 4. Collector-emitter on voltage vs temperature

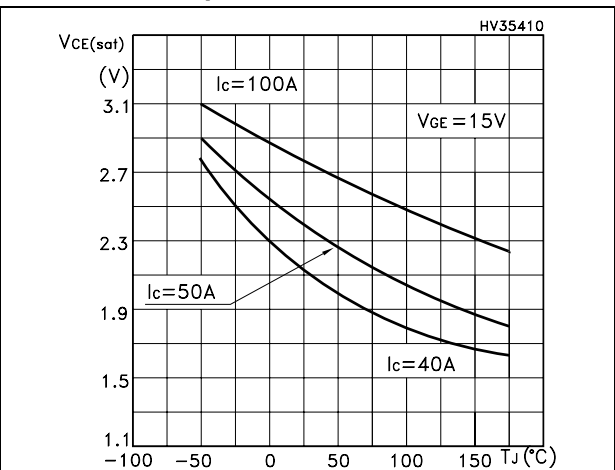

Figure 5. Gate charge vs gate-source voltage

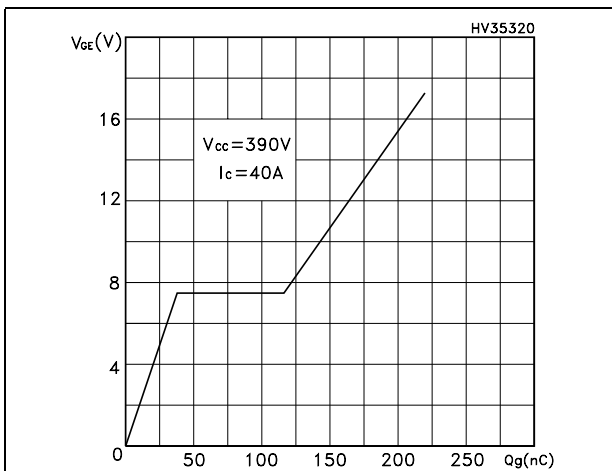

Figure 6. Capacitance variations

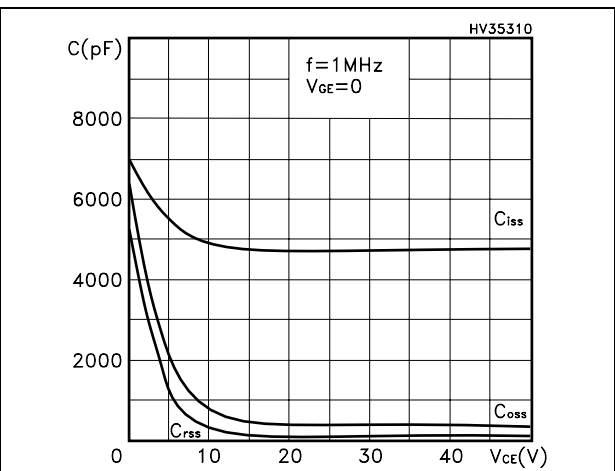

Figure 7. Normalized gate threshold voltage vs temperature

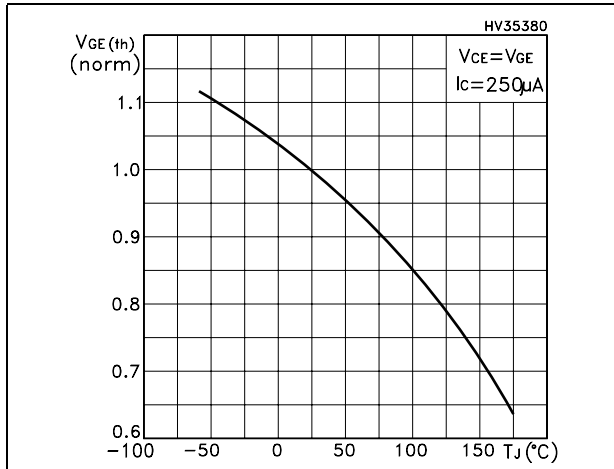

Figure 8. Collector-emitter on voltage vs collector current

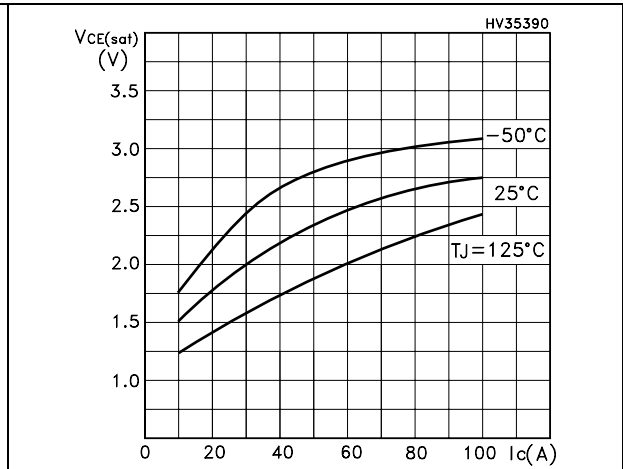

Figure 9. Normalized breakdown voltage vs temperature

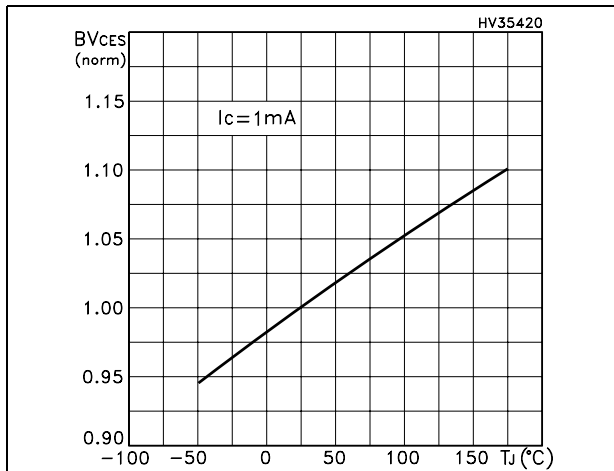

Figure 10. Switching losses vs temperature

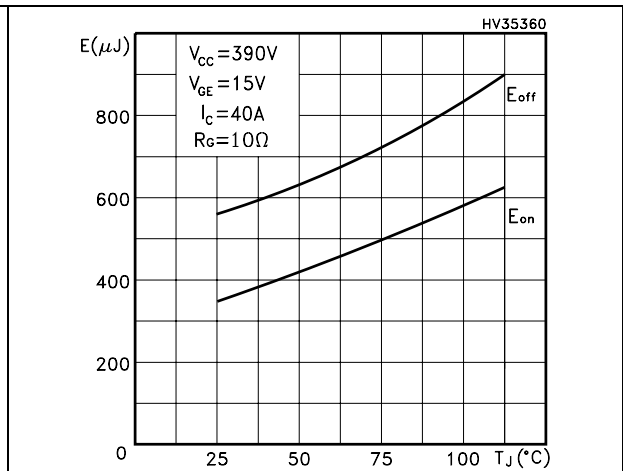

Figure 11. Switching losses vs gate resistance

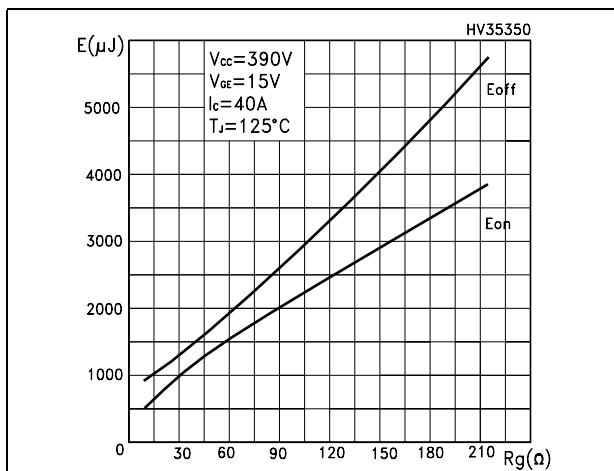

Figure 12. Switching losses vs collector current

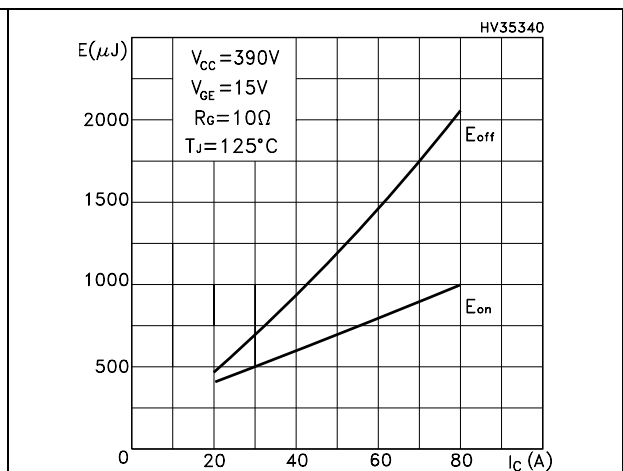



Figure 13. Turn-off SOA

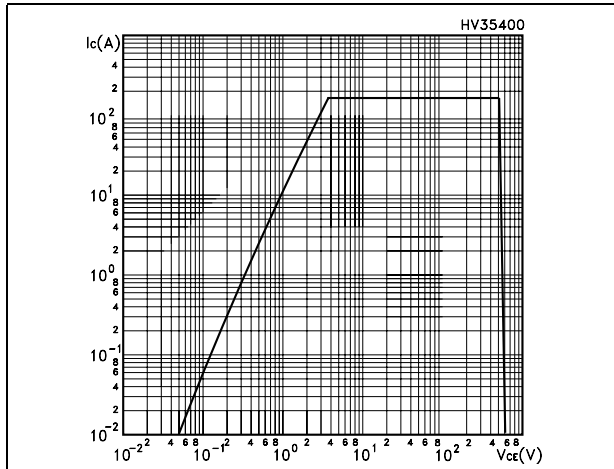
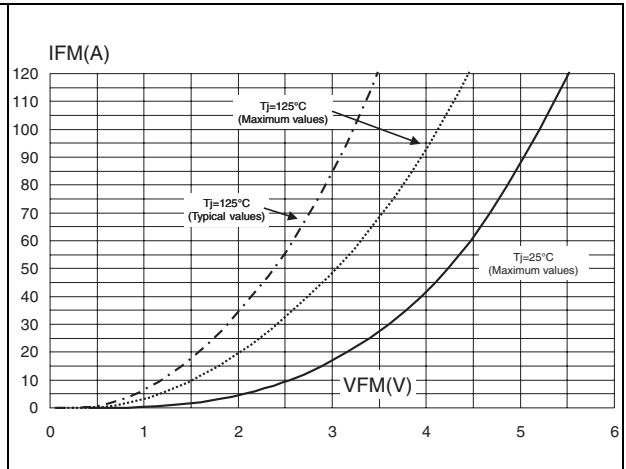

Figure 14. Forward voltage drop vs. forward current



### 3 Test circuit

Figure 15. Test circuit for inductive load switching



Figure 16. Gate charge test circuit

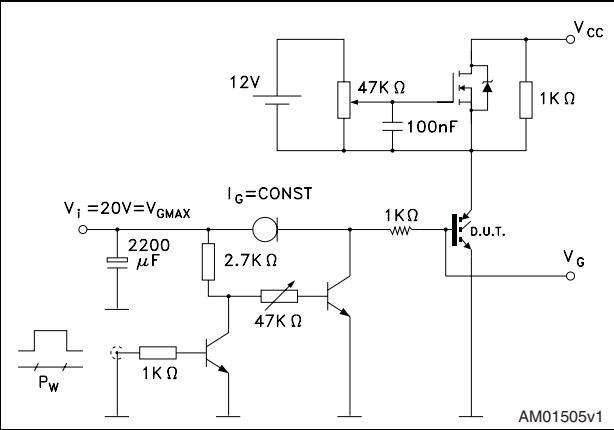

Figure 17. Switching waveform

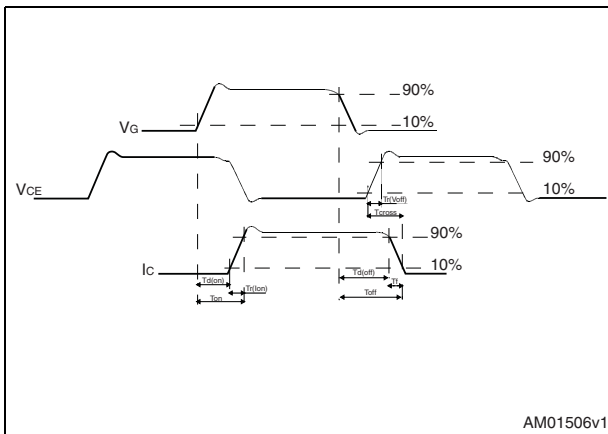
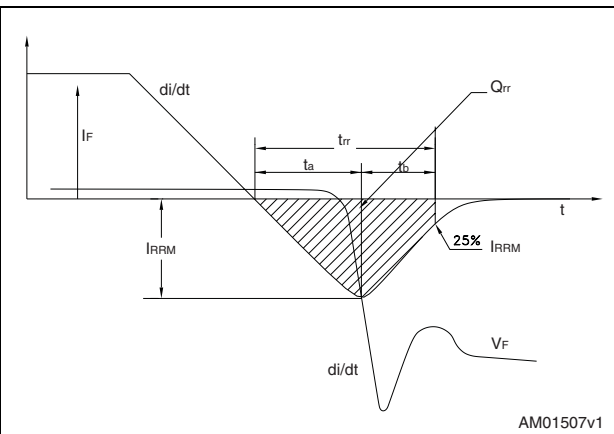

Figure 18. Diode recovery time waveform



## 4 Package mechanical data

In order to meet environmental requirements, ST offers these devices in different grades of ECOPACK® packages, depending on their level of environmental compliance. ECOPACK® specifications, grade definitions and product status are available at: [www.st.com](http://www.st.com). ECOPACK® is an ST trademark.

Table 8. Max247 mechanical data

Dim.	mm		
	Min.	Typ.	Max.
A	4.70		5.30
A1	2.20		2.60
b	1.00		1.40
b1	2.00		2.40
b2	3.00		3.40
c	0.40		0.80
D	19.70		20.30
e	5.35		5.55
E	15.30		15.90
L	14.20		15.20
L1	3.70		4.30

Figure 19. Max247 drawing

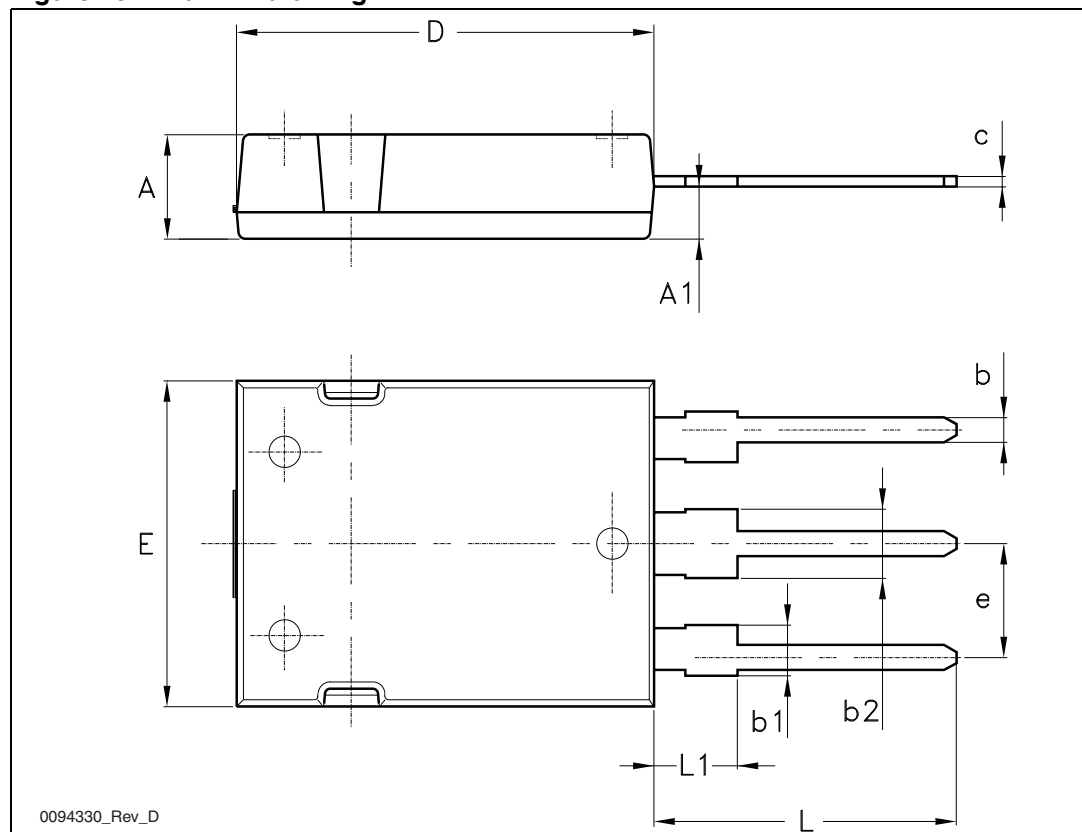

## 5 Revision history

**Table 9. Document revision history**

Date	Revision	Changes
09-Oct-2006	1	Initial release.
07-May-2007	2	Complete version
02-Jul-2007	3	Modified value on <a href="#">Table 2: Thermal resistance</a>
04-Nov-2008	4	<a href="#">Table 8: Max247 mechanical data</a> and <a href="#">Figure 19: Max247 drawing</a> have been updated.
09-Jan-2009	5	<a href="#">Figure 13: Turn-off SOA</a> has been updated.

**Please Read Carefully:**

Information in this document is provided solely in connection with ST products. STMicroelectronics NV and its subsidiaries ("ST") reserve the right to make changes, corrections, modifications or improvements, to this document, and the products and services described herein at any time, without notice.

All ST products are sold pursuant to ST's terms and conditions of sale.

Purchasers are solely responsible for the choice, selection and use of the ST products and services described herein, and ST assumes no liability whatsoever relating to the choice, selection or use of the ST products and services described herein.

No license, express or implied, by estoppel or otherwise, to any intellectual property rights is granted under this document. If any part of this document refers to any third party products or services it shall not be deemed a license grant by ST for the use of such third party products or services, or any intellectual property contained therein or considered as a warranty covering the use in any manner whatsoever of such third party products or services or any intellectual property contained therein.

**UNLESS OTHERWISE SET FORTH IN ST'S TERMS AND CONDITIONS OF SALE ST DISCLAIMS ANY EXPRESS OR IMPLIED WARRANTY WITH RESPECT TO THE USE AND/OR SALE OF ST PRODUCTS INCLUDING WITHOUT LIMITATION IMPLIED WARRANTIES OF MERCHANTABILITY, FITNESS FOR A PARTICULAR PURPOSE (AND THEIR EQUIVALENTS UNDER THE LAWS OF ANY JURISDICTION), OR INFRINGEMENT OF ANY PATENT, COPYRIGHT OR OTHER INTELLECTUAL PROPERTY RIGHT.**

**UNLESS EXPRESSLY APPROVED IN WRITING BY AN AUTHORIZED ST REPRESENTATIVE, ST PRODUCTS ARE NOT RECOMMENDED, AUTHORIZED OR WARRANTED FOR USE IN MILITARY, AIR CRAFT, SPACE, LIFE SAVING, OR LIFE SUSTAINING APPLICATIONS, NOR IN PRODUCTS OR SYSTEMS WHERE FAILURE OR MALFUNCTION MAY RESULT IN PERSONAL INJURY, DEATH, OR SEVERE PROPERTY OR ENVIRONMENTAL DAMAGE. ST PRODUCTS WHICH ARE NOT SPECIFIED AS "AUTOMOTIVE GRADE" MAY ONLY BE USED IN AUTOMOTIVE APPLICATIONS AT USER'S OWN RISK.**

Resale of ST products with provisions different from the statements and/or technical features set forth in this document shall immediately void any warranty granted by ST for the ST product or service described herein and shall not create or extend in any manner whatsoever, any liability of ST.

ST and the ST logo are trademarks or registered trademarks of ST in various countries.

Information in this document supersedes and replaces all information previously supplied.

The ST logo is a registered trademark of STMicroelectronics. All other names are the property of their respective owners.

© 2009 STMicroelectronics - All rights reserved

STMicroelectronics group of companies

Australia - Belgium - Brazil - Canada - China - Czech Republic - Finland - France - Germany - Hong Kong - India - Israel - Italy - Japan - Malaysia - Malta - Morocco - Singapore - Spain - Sweden - Switzerland - United Kingdom - United States of America

[www.st.com](http://www.st.com)



Компания «ЭлектроПласт» предлагает заключение долгосрочных отношений при поставках импортных электронных компонентов на взаимовыгодных условиях!

Наши преимущества:

- Оперативные поставки широкого спектра электронных компонентов отечественного и импортного производства напрямую от производителей и с крупнейших мировых складов;
- Поставка более 17-ти миллионов наименований электронных компонентов;
- Поставка сложных, дефицитных, либо снятых с производства позиций;
- Оперативные сроки поставки под заказ (от 5 рабочих дней);
- Экспресс доставка в любую точку России;
- Техническая поддержка проекта, помощь в подборе аналогов, поставка прототипов;
- Система менеджмента качества сертифицирована по Международному стандарту ISO 9001;
- Лицензия ФСБ на осуществление работ с использованием сведений, составляющих государственную тайну;
- Поставка специализированных компонентов (Xilinx, Altera, Analog Devices, Intersil, Interpoint, Microsemi, Aeroflex, Peregrine, Syfer, Eurofarad, Texas Instrument, Miteq, Cobham, E2V, MA-COM, Hittite, Mini-Circuits, General Dynamics и др.);

Помимо этого, одним из направлений компании «ЭлектроПласт» является направление «Источники питания». Мы предлагаем Вам помощь Конструкторского отдела:

- Подбор оптимального решения, техническое обоснование при выборе компонента;
- Подбор аналогов;
- Консультации по применению компонента;
- Поставка образцов и прототипов;
- Техническая поддержка проекта;
- Защита от снятия компонента с производства.



#### Как с нами связаться

**Телефон:** 8 (812) 309 58 32 (многоканальный)

**Факс:** 8 (812) 320-02-42

**Электронная почта:** [org@eplast1.ru](mailto:org@eplast1.ru)

**Адрес:** 198099, г. Санкт-Петербург, ул. Калинина, дом 2, корпус 4, литера А.