

# KSA & KSL Series Sealed Tact Switch



## Features/Benefits

- Designed for automatic or manual insertion
- Cambered terminals to ensure self retention
- Top or side actuated
- Large choice of caps
- RoHS compliant and compatible

## Typical Applications

- Automotive
- Industrial
- Telecommunication networks

Tactile Switches

B

## Specification

CONTACT ARRANGEMENT: SPST, N.O.  
 DOUBLE OVERMOLDING ON TERMINAL  
 SEALING: IP60  
 TERMINALS: PC pins, ground pin optional

## Mechanical

Type	Actuation force N	Operating life (operations)	Travel to make
KSA0M211	1,4 ± 0,4	100,000	0,5 ± 0,2
KSA0M311	1,4 ± 0,4	1,000,000	0,5 ± 0,2
KSA0M411	3 ± 0,75	100,000	0,6 ± 0,2
KSA0M511	5 ± 1,5	100,000	0,7 ± 0,2
KSA0M911	3 ± 0,75	500,000	0,6 ± 0,2
KSL0M211	1,4 ± 0,4	100,000	0,5 ± 0,2
KSL0M311	1,4 ± 0,4	1,000,000	0,5 ± 0,2
KSL0M411	3 ± 0,75	100,000	0,6 ± 0,2
KSL0M511	5 ± 1,5	100,000	0,7 ± 0,2
KSL0M911	3 ± 0,75	500,000	0,6 ± 0,2

**NOTE:** Other versions in terms of force, termination length and corrosion protection available. Please contact your sales representative.  
 This data sheet does not provide enough information for applications which require a certain level of quality or safety such as automotive, medical systems, safety equipment. Please contact your sales representative to get contractual specification package.

## Electrical

	Silver	Gold
MAXIMUM POWER:	1 VA	0.2 VA
MAXIMUM VOLTAGE:	32 VDC	32 VDC
MINIMUM VOLTAGE:	20 mV	20 mV
MAXIMUM CURRENT:	50 mA	10 mA
MINIMUM CURRENT:	1 mA	1 mA
DIELECTRIC STRENGTH: 250 Vrms		
CONTACT RESISTANCE: ≤ 100m Ω		
INSULATION RESISTANCE (100 V): ≥ 10 <sup>9</sup> Ω		
BOUNCE TIME: ≤ 1 ms		

## Environmental

	Silver	Gold
OPERATING TEMPERATURE:	-40°C to 85°C	-40°C to 125°C
STORAGE TEMPERATURE:	-40°C to 85°C	-55°C to 125°C

## Process

Wave soldering compatible with lead free soldering profile.

## Packaging

Can be delivered in tubes of 65 pieces for automatic insertion or in boxes of 500 pieces for manual insertion (250 pieces for KSL, KSLV, KSAV).

## How To Order

Our easy build-a-switch concept allows you to mix and match options to create the switch you need. To order, select desired option from each category and place it in the appropriate box.

However, please note that all the combinations of these options are not feasible.

For any part number different from those listed above, please consult your local representative.

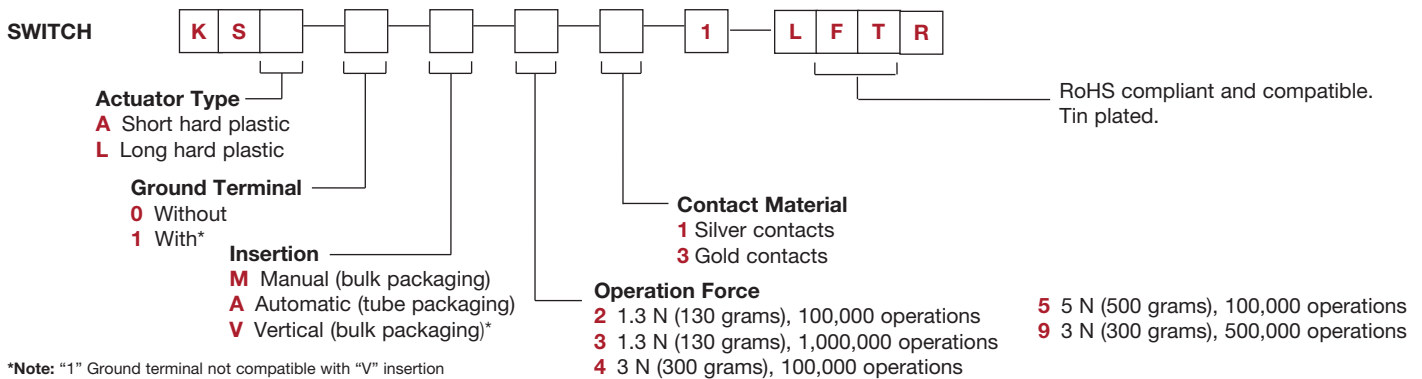

**BUTTONS** Buttons must be ordered separately and will be supplied in bulk.

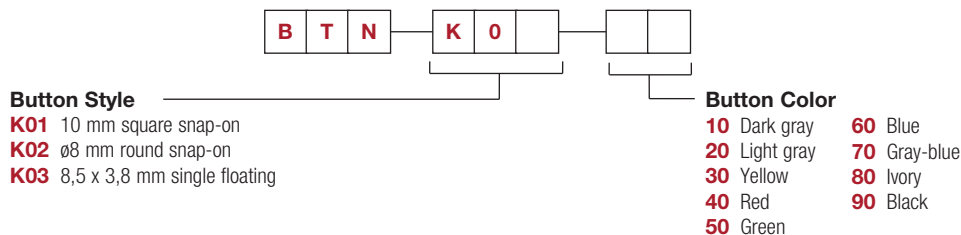

# KSA & KSL Series Sealed Tact Switch

ACTUATOR TYPE

## KSA & KSL

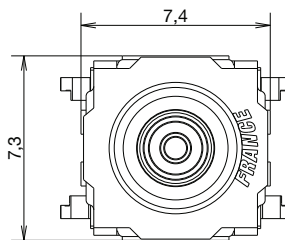

Type	H mm	inch
KSA	4,7±0,2	(.185)
KSL	9,9±0,2	(.390)

Tactile Switches

GROUND TERMINAL

0 WITHOUT

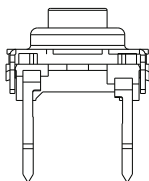

1\* WITH

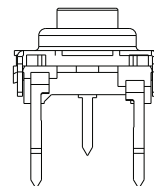

\*Not compatible with "V" insertion



First Angle  
Projection

Dimensions are shown: mm  
Specifications and dimensions subject to change

# KSA & KSL Series Sealed Tact Switch

## INSERTION

### M MANUAL (BULK PACKAGING)

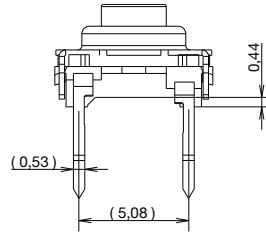

### PCB LAYOUT

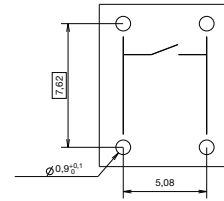

### A AUTOMATIC (TUBE PACKAGING, 65 PIECES PER TUBE)



### PCB LAYOUT

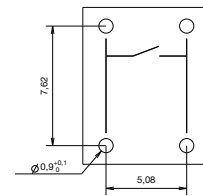

### V VERTICAL

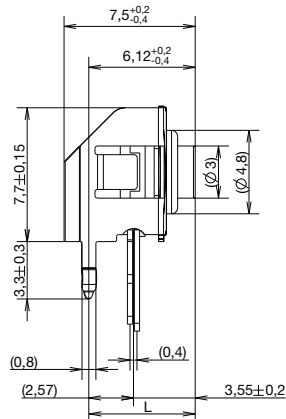
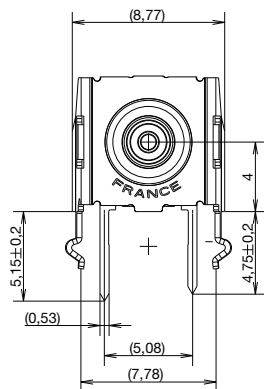

### PCB LAYOUT



### DIMENSION L

Type	L mm	inch
KSA0V	5,8	.228
KSL0V	11,1	.437

## OPERATING FORCE

OPTION CODE	OPERATING FORCE
<b>2</b>	1.3 N (130 grams) 100,000 operations
<b>3</b>	1.3 N (130 grams) 1,000,000 operations
<b>4</b>	3.0 N (300 grams) 100,000 operations
<b>5</b>	5.0 N (500 grams) 100,000 operations
<b>9</b>	3.0 N (300 grams) 500,000 operations



First Angle  
Projection

Dimensions are shown: mm  
Specifications and dimensions subject to change

## CONTACT MATERIAL



OPTION CODE	CONTACT MATERIAL
<b>1</b>	Silver contacts
<b>3</b>	Gold contacts

## SEALING



OPTION CODE	SEALING
<b>1</b>	Sealing level IP60

## BUTTONS

Buttons must be ordered separately and will be supplied in bulk.

BUTTON TYPE	KSA	KSL	KSAV	KSLV
<b>K01</b>	X			
<b>K02</b>	X			
<b>K03</b>	X	X	X	X

**K01**



Dimensions are shown: mm  
Specifications and dimensions subject to change

# KSA & KSL Series Sealed Tact Switch

**K02**

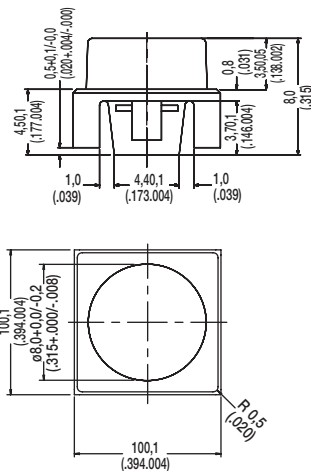
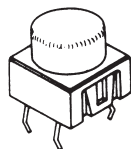

**K03**

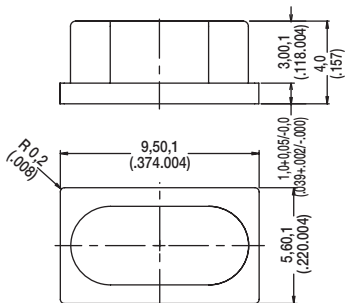

First Angle  
Projection

Dimensions are shown: mm  
Specifications and dimensions subject to change



Компания «ЭлектроПласт» предлагает заключение долгосрочных отношений при поставках импортных электронных компонентов на взаимовыгодных условиях!

Наши преимущества:

- Оперативные поставки широкого спектра электронных компонентов отечественного и импортного производства напрямую от производителей и с крупнейших мировых складов;
- Поставка более 17-ти миллионов наименований электронных компонентов;
- Поставка сложных, дефицитных, либо снятых с производства позиций;
- Оперативные сроки поставки под заказ (от 5 рабочих дней);
- Экспресс доставка в любую точку России;
- Техническая поддержка проекта, помощь в подборе аналогов, поставка прототипов;
- Система менеджмента качества сертифицирована по Международному стандарту ISO 9001;
- Лицензия ФСБ на осуществление работ с использованием сведений, составляющих государственную тайну;
- Поставка специализированных компонентов (Xilinx, Altera, Analog Devices, Intersil, Interpoint, Microsemi, Aeroflex, Peregrine, Syfer, Eurofarad, Texas Instrument, Miteq, Cobham, E2V, MA-COM, Hittite, Mini-Circuits, General Dynamics и др.);

Помимо этого, одним из направлений компании «ЭлектроПласт» является направление «Источники питания». Мы предлагаем Вам помощь Конструкторского отдела:

- Подбор оптимального решения, техническое обоснование при выборе компонента;
- Подбор аналогов;
- Консультации по применению компонента;
- Поставка образцов и прототипов;
- Техническая поддержка проекта;
- Защита от снятия компонента с производства.



#### Как с нами связаться

**Телефон:** 8 (812) 309 58 32 (многоканальный)

**Факс:** 8 (812) 320-02-42

**Электронная почта:** [org@eplast1.ru](mailto:org@eplast1.ru)

**Адрес:** 198099, г. Санкт-Петербург, ул. Калинина, дом 2, корпус 4, литера А.