

General Specifications

Electrical Capacity (Resistive Load)

| | | |
|------------------------------|---|--|
| Power Level (silver): | 6A @ 125V AC or 3A @ 250V AC or 3A @ 30V DC | |
| Logic Level (gold): | 0.4VA maximum @ 28V AC/DC maximum (Applicable Range 0.1mA ~ 0.1A @ 20mV ~ 28V) | |
| | Note: Find additional explanation of operating range in Supplement section. | |

Other Ratings

| | | |
|---------------------------------|--|--------------------|
| Contact Resistance: | 10 milliohms maximum for silver; 20 milliohms maximum for gold | |
| Insulation Resistance: | 1,000 megohms minimum @ 500V DC | |
| Dielectric Strength: | 1,000V AC minimum between contacts for 1 minute minimum; 1,500V AC minimum between contacts & case for 1 minute minimum | |
| Mechanical Life: | 50,000 operations minimum | |
| Electrical Life: | 25,000 operations minimum | |
| Nominal Operating Force: | On-to-On Position | Off-to-On Position |
| | Single Pole | 3.19N |
| | Double Pole | 4.41N |
| | | 3.92N |
| | | 7.06N |
| Angle of Throw: | 20° | |

Materials & Finishes

| | |
|-----------------------------|---|
| Bushing: | Brass with nickel plating |
| Housing: | Stainless steel |
| Mounting Bracket: | Steel with tin plating |
| Movable Contacts: | Silver alloy or silver alloy with gold plating |
| Stationary Contacts: | Silver with silver plating or copper or brass with gold plating |
| Lamp Contacts: | Phosphor bronze |
| Base: | Diallyl phthalate (UL94V-0) |
| Switch Terminals: | Copper with silver or gold plating |
| Lamp Terminals: | Brass with silver or gold plating |

Environmental Data

| | |
|------------------------------|--|
| Operating Temp Range: | -10°C through +55°C (+14°F through +131°F) |
| Humidity: | 90 ~ 95% humidity for 96 hours @ 40°C (104°F) |
| Vibration: | 10 ~ 55Hz with peak-to-peak amplitude of 1.5mm traversing the frequency range & returning in 1 minute; 3 right angled directions for 2 hours |
| Shock: | 50G (490m/s ²) acceleration (tested in 6 right angled directions, with 5 shocks in each direction) |

Installation

| | |
|-----------------------------------|--|
| Mounting Torque: | 1.47Nm (13 lb•in) for double nut; .67Nm (6 lb•in) for single nut |
| Soldering Time & Temp: | Wave Soldering (PC version): See Profile B in Supplement section. Manual Soldering: See Profile B in Supplement section. Note: Lever must be in center position while soldering. |
| Cleaning: | PC mountable device is not process sealed. Hand clean locally using alcohol based solution. |

Standards & Certifications

| | |
|--------------------------------|--|
| Flammability Standards: | UL94V-0 base |
| UL: | File No. E44145 - Recognized only when ordered with marking on switch. Add "/U" to end of part number to order UL recognized switch. Single pole with synchronous circuits & single color LEDs & solder lug or PC recognized at 6A @ 125V AC. |
| CSA: | File No. 023535_0_000 - Certified only when ordered with marking on switch. Add "/C" to end of part number to order CSA certified switch. All single pole with synchronous circuits & single color LEDs certified at 6A @ 125V AC. |

Distinctive Characteristics

Industry's first LED illumination at tip of toggle switches.

Single color LEDs of red, yellow, and green, plus bicolor red/green, to meet varied design requirements.

LEDs can operate independently from or synchronously with switching operation.

Antijamming feature to protect contacts from damage due to excessive downward force on the toggle.

High torque bushing prevents the bushing from rotating or separating from the metal frame during installation.

Stainless steel frame resists corrosion.

Silver contacts are of specially composed alloy for hardness.

High insulating barriers protect against crossover in double pole devices.

Terminals are molded in and epoxy sealed to lock out flux, dust, and other contaminants.

1,500V dielectric strength between switch contacts and case is accomplished by clinching the frame away from the terminals.



Actual Size

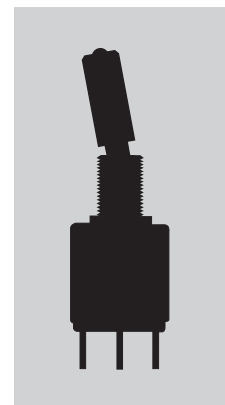

A

Toggles

Rockers

Pushbuttons

Illuminated PB

Programmable

Keylocks

Rotaries

Slides

Tactiles

Tilt

Touch

Indicators

Accessories

Supplement

TYPICAL SWITCH ORDERING EXAMPLE

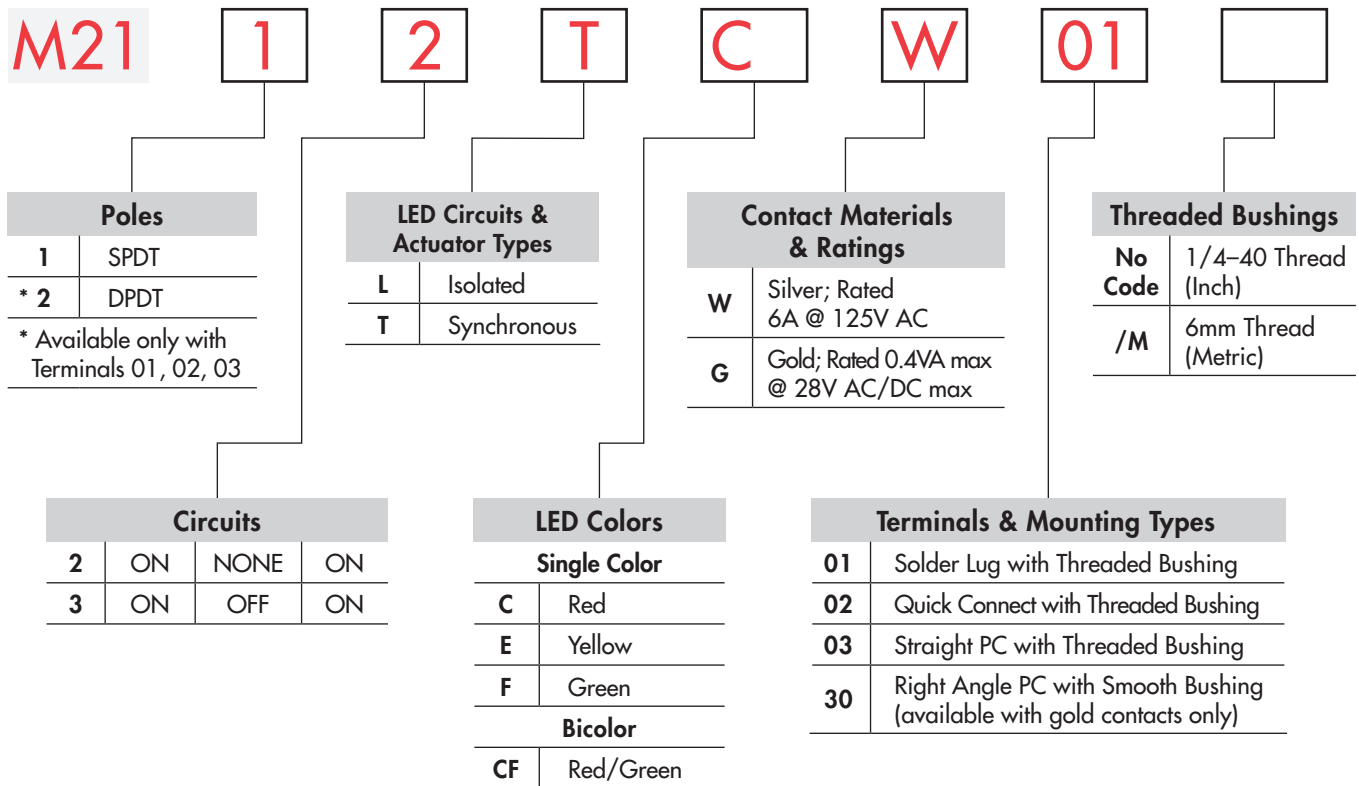

IMPORTANT:





Switches are supplied without UL & CSA marking unless specified.
UL & CSA recognized only when ordered with marking on the switch.
 Specific models, ratings, & ordering instructions are noted on the General Specifications page.

DESCRIPTION FOR TYPICAL ORDERING EXAMPLE

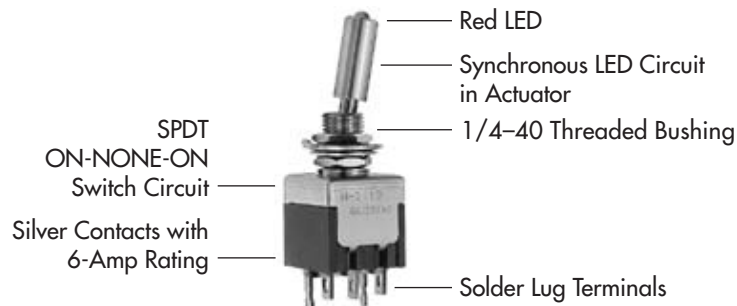
M2112TCW01



| POLES & CIRCUITS & LED ILLUMINATION | | | | | |
|--|---|--|--|--|--|
| Model | Pole & Throw | Toggle Position & Terminal Numbers | | | Schematics |
| | | Down Keyway  | Center  | Up  | |
| M2112 SPDT Connected Power Terminals | | ON 2-3 | NONE NONE | ON 2-1 | <p>Notes: Terminal numbers are not actually on the switch. LEDs require an external power source.</p> <p>Isolated Single Color LED </p> <p>Isolated Bicolor LED </p> |
| LED Circuit | Isolated LEDs (see schematics) Connected LED Terminals | ON 4-6 | NONE NONE | ON 4-6 | |
| | Synchronous Single Color LED Connected LED Terminals | ON 4-6 | NONE NONE | OFF OPEN | |
| M2113 SPDT Connected Power Terminals | | ON 2-3 | OFF OPEN | ON 2-1 | <p>Synchronous Single Color LED </p> <p>Synchronous Bicolor LED </p> |
| LED Circuit | Isolated LEDs (see schematics) Connected LED Terminals | ON 4-6 | ON 4-6 | ON 4-6 | |
| | Synchronous Single Color LED Connected LED Terminals | ON 4-6 | OFF OPEN | ON 4-6 | |
| M2122 DPDT Connected Power Terminals | | ON 2-3 5-6 | NONE NONE | ON 2-1 5-4 | <p>Isolated Single Color LED </p> <p>Isolated Bicolor LED </p> |
| LED Circuit | Isolated LEDs (see schematics) Connected LED Terminals | ON 7-9 | NONE NONE | ON 7-9 | |
| | Synchronous Single Color LED Connected LED Terminals | ON 7-9 | NONE NONE | OFF OPEN | |
| M2123 DPDT Connected Power Terminals | | ON 2-3 5-6 | OFF OPEN | ON 2-1 5-4 | <p>Synchronous Single Color LED </p> <p>Synchronous Bicolor LED </p> |
| LED Circuit | Isolated LEDs (see schematics) Connected LED Terminals | ON 7-9 | ON 7-9 | ON 7-9 | |
| | Synchronous Single Color LED Connected LED Terminals | ON 7-9 | OFF OPEN | ON 7-9 | |
| M2123 DPDT Connected Power Terminals | | ON 2-3 5-6 | OFF OPEN | ON 2-1 5-4 | <p>Synchronous Single Color LED </p> <p>Synchronous Bicolor LED </p> |
| LED Circuit | Isolated LEDs (see schematics) Connected LED Terminals | ON 7-9 | ON 7-9 | ON 7-9 | |
| | Synchronous Single Color LED Connected LED Terminals | ON 7-9 | OFF OPEN | ON 7-9 | |
| M2123 DPDT Connected Power Terminals | | ON 2-3 5-6 | OFF OPEN | ON 2-1 5-4 | <p>Synchronous Single Color LED </p> <p>Synchronous Bicolor LED </p> |
| LED Circuit | Isolated LEDs (see schematics) Connected LED Terminals | ON 7-9 | ON 7-9 | ON 7-9 | |
| | Synchronous Single Color LED Connected LED Terminals | ON 7-9 | OFF OPEN | ON 7-9 | |

LED COLORS & SPECIFICATIONS

The electrical specifications shown are determined at a basic temperature of 25°C. LED circuit is isolated and requires an external power source. If the source voltage exceeds the rated voltage, a ballast resistor is required. The resistor value can be calculated by using the formula in Supplement Section.

| | Color | Single Color | | | Bicolor | |
|--|--------------|-----------------|--------------------|-------------------|------------------------|-------|
| | | C Red | E Yellow | F Green | CF Red/Green | Units |
| The LED is an integral part of the switch and not available separately. Bicolor LED is translucent white when unlit. | | | | | | |
| Maximum Forward Current | I_{FM} | 25 | 30 | 30 | 25 | mA |
| Typical Forward Current | I_F | 20 | 20 | 20 | 10 | mA |
| Forward Voltage | V_F | 2.1 | 2.1 | 2.1 | 1.7/2.0 | V |
| Maximum Reverse Voltage | V_{RM} | 4 | 4 | 4 | — | V |
| Current Reduction Rate Above 25°C | ΔI_F | 0.33 | 0.40 | 0.40 | 0.33/0.33 | mA/°C |
| Ambient Temperature Range | | -10° ~ +55°C | | | | |

LED CIRCUIT, TOGGLE, & MOUNTING TYPE COMBINATIONS

L Toggle with Isolated LED Circuit

T Toggle with Synchronous LED Circuit

Finish: Brushed aluminum

Standard Hardware: 2 AT513H Hex Nuts, 1 AT507H Locking Ring, 1 AT509 Lockwasher Standard & optional hardware details in Accessories & Hardware section.

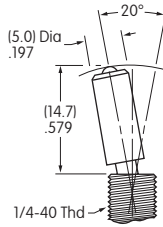

Threaded Bushing combines with Terminal codes 01, 02, & 03.

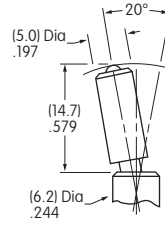

Smooth Bushing combines with Terminal code 30.

Max. Panel Thickness with Standard Hardware .102" (2.6mm)

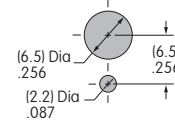

Max. Panel Thickness without Locking Ring .134" (3.4mm)

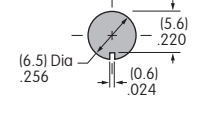

TYPICAL SWITCH DIMENSIONS

Solder Lug



M2112TCFW01

Single Pole

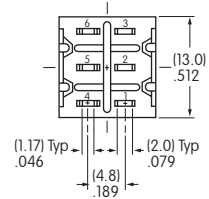
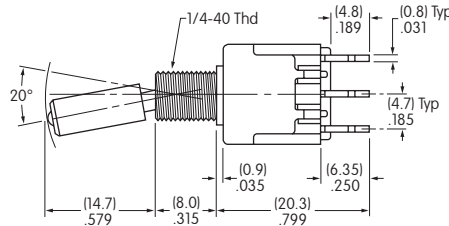
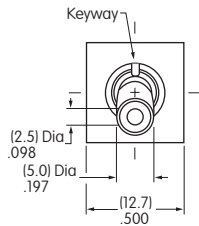

Single color LED switch does not have terminal 5.

Solder Lug



M2122TCFW01

Double Pole

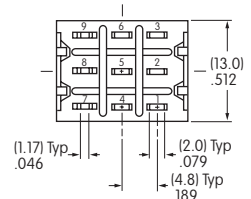
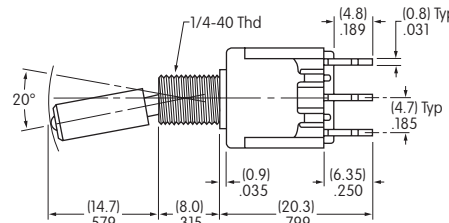
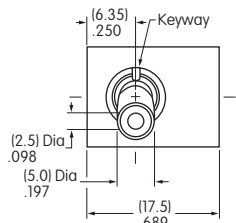

Single color LED switch does not have terminal 8.

Right Angle PC



M2112TCFG30

Single Pole Only

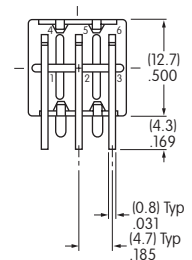
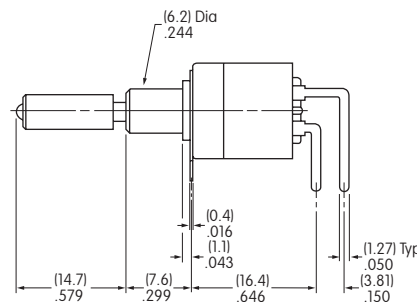
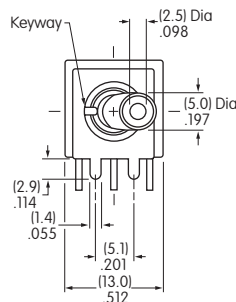

Single color LED switch does not have terminal 5.

Gold contact material only

Toggles
 Rockers
 Pushbuttons
 Illuminated PB
 Programmable
 Keylocks
 Rotaries
 Slides
 Tactiles
 Tilt
 Touch
 Indicators
 Accessories
 Supplement

CONTACT MATERIALS & RATINGS

W

Silver over Silver

Power Level

6A @ 125V AC & 3A @ 250V AC

G

Gold over Brass or Copper

Logic Level

0.4VA maximum @ 28V AC/DC maximum

Complete explanation of operating range in Supplement section.

TERMINALS

01

Solder Lug with Turret LED Terminal

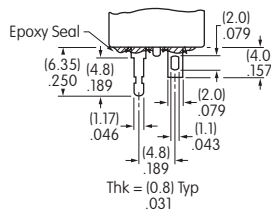

02

Quick Connect

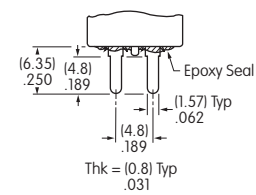

03

Straight PC with Turret LED Terminal

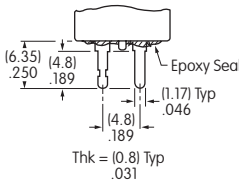

Single Pole

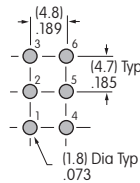

Single color LED & isolated bicolor LED switches do not have terminal 5.

Double Pole

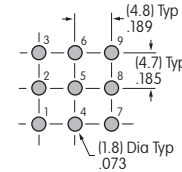

Single color LED & isolated bicolor LED switches do not have terminal 8.

30

Right Angle PC

LED terminals only available in brass with silver plating

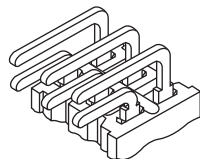

Single Pole

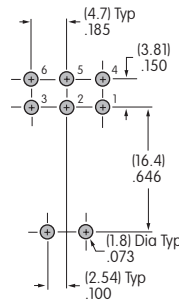

Single color LED & isolated bicolor LED switches do not have terminal 5.

STANDARD MOUNTING HARDWARE

AT513H

Hexagon Nuts (2 per switch)

Material: Brass with nickel plating

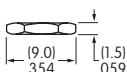
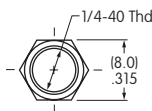

AT507H

Locking Ring (1 per switch)

Material: Steel with chromate over zinc

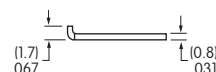
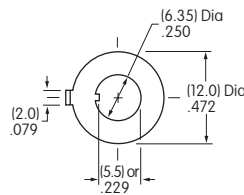

AT509

Lockwasher (1 per switch)

Material: Steel with chromate over zinc

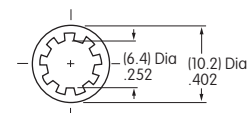

Optional Hardware: Knurled nuts, dress nuts, and ON-OFF plates are available; see details in Accessories & Hardware section.

General Specifications

Toggle

Rockers

Pushbuttons

Illuminated PB

Programmable

Keylocks

Rotaries

Slides

Tactiles

Tilt

Touch

Indicators

Accessories

Supplement

B Electrical Capacity (Resistive Load)

Power Level (silver): 6A @ 125V AC or 3A @ 250V AC or 3A @ 30V DC
Logic Level (gold): 0.4VA maximum @ 28V AC/DC maximum
 (Applicable Range 0.1mA ~ 0.1A @ 20mV ~ 28V)
 Note: Find additional explanation of operating range in Supplement section.

Other Ratings

Contact Resistance: 10 milliohms maximum for silver; 20 milliohms maximum for gold
Insulation Resistance: 1,000 megohms minimum @ 500V DC
Dielectric Strength: 1,000V AC minimum between contacts for 1 minute minimum;
 1,500V AC minimum between contacts & case for 1 minute minimum

Mechanical Life: 50,000 operations minimum
Electrical Life: 25,000 operations minimum

| Nominal Operating Force: | | On-to-On Position | Off-to-On Position |
|---------------------------------|-------------|-------------------|--------------------|
| Paddles | Single Pole | 3.19N | 3.92N |
| | Double Pole | 4.41N | 7.06N |
| Rockers | Single Pole | 6.37N | 9.80N |
| | Double Pole | 13.73N | 17.65N |

Angle of Throw: 20°

Materials & Finishes

Housing: Stainless steel
Mounting Bracket: Steel with tin plating
Movable Contacts: Silver alloy or silver alloy with gold plating
Stationary Contacts: Silver with silver plating or copper or brass with gold plating
Lamp Contacts: Phosphor bronze
Base: Diallyl phthalate (UL94V-0)
Switch Terminals: Copper with silver or gold plating
Lamp Terminals: Brass with silver or gold plating

Environmental Data

Operating Temp Range: -10°C through +55°C (+14°F through +131°F) for rockers
 -25°C through +70°C (-13°F through +158°F) for paddles
Humidity: 90 ~ 95% humidity for 96 hours @ 40°C (104°F)
Vibration: 10 ~ 55Hz with peak-to-peak amplitude of 1.5mm traversing the frequency range & returning in 1 minute; 3 right angled directions for 2 hours
Shock: 50G (490m/s²) acceleration (tested in 6 right angled directions, with 5 shocks in each direction)

Installation

Soldering Time & Temp: Wave Soldering (PC version): See Profile B in Supplement section.
 Manual Soldering: See Profile B in Supplement section.
 Note: Lever must be in center position while soldering.
Cleaning: PC mountable device is not process sealed. Hand clean locally using alcohol based solution.

Standards & Certifications

Flammability Standards: UL94V-0 base
UL: **File No. E44145 - Recognized only when ordered with marking on switch.**
 Add "/U" before dash in part number to order UL recognized switch.
 Single pole rockers with synchronous circuits & single color LEDs & solder lug or PC recognized at 6A @ 125V AC.
CSA: **File No. 023535_0_000 - Certified only when ordered with marking on switch.**
 Add "/C" before dash in part number to order CSA certified switch.
 All single pole rockers with synchronous circuits & single color LEDs certified at 6A @ 125V AC.

TYPICAL SWITCH ORDERING EXAMPLE

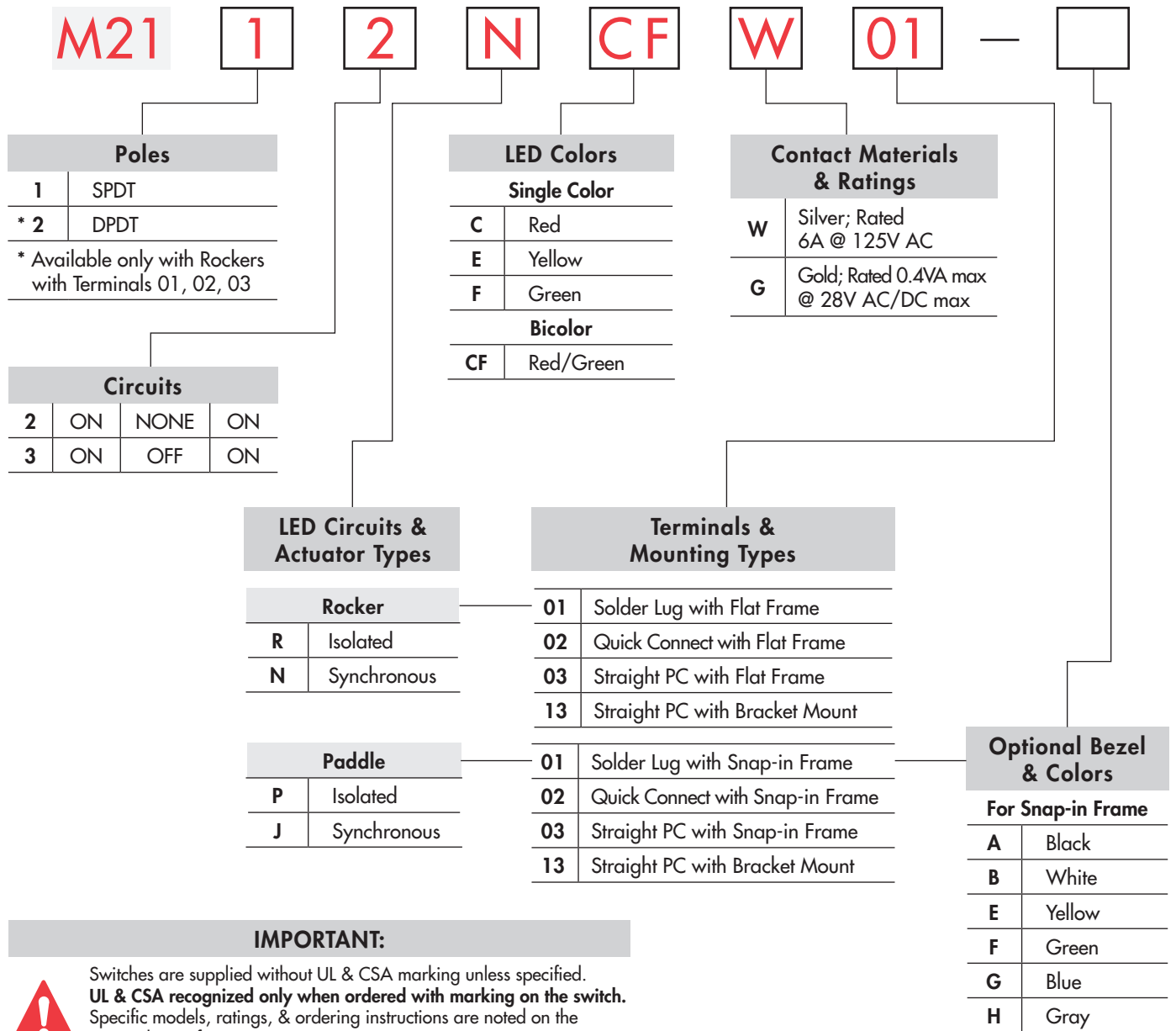

IMPORTANT:





Switches are supplied without UL & CSA marking unless specified. **UL & CSA recognized only when ordered with marking on the switch.** Specific models, ratings, & ordering instructions are noted on the General Specifications page.

DESCRIPTION FOR TYPICAL ORDERING EXAMPLE

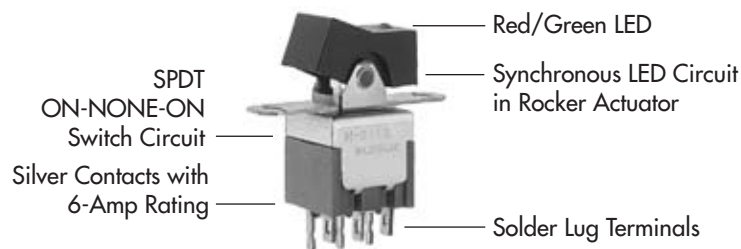
M2112NCFW01

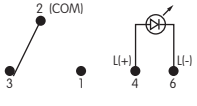
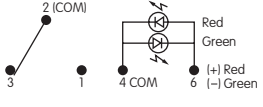
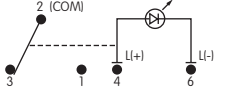
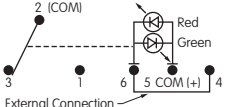
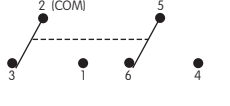
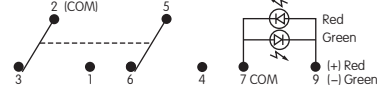
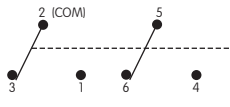
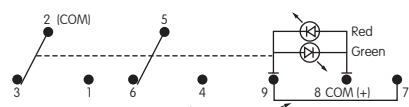

POLES & CIRCUITS & LED ILLUMINATION

| Model | Pole & Throw | Toggle Position & Terminal Numbers | | | Schematics |
|---|--|---|---|---|---|
| | | Down  | Center  | Up  | |
| M2112 Connected Power Terminals | SPDT | ON 2-3 | NONE NONE | ON 2-1 | Notes: Terminal numbers are not actually on the switch. LEDs require an external power source.   |
| LED Circuit | Isolated LEDs (see schematics) Connected LED Terminals | ON 4-6 | NONE NONE | ON 4-6 | |
| | Synchronous Single Color LED Connected LED Terminals | ON 4-6 | NONE NONE | OFF OPEN | |
| | Synchronous Bicolor LED Connected LED Terminals | Red 5-6 | NONE NONE | Green 5-4 | |
| M2113 Connected Power Terminals | SPDT | ON 2-3 | OFF OPEN | ON 2-1 |   |
| LED Circuit | Isolated LEDs (see schematics) Connected LED Terminals | ON 4-6 | ON 4-6 | ON 4-6 | |
| | Synchronous Single Color LED Connected LED Terminals | ON 4-6 | OFF OPEN | ON 4-6 | |
| | Synchronous Bicolor LED Connected LED Terminals | Red 5-6 | OFF OPEN | Green 5-4 | |
| M2122 Connected Power Terminals | DPDT | ON 2-3 5-6 | NONE NONE | ON 2-1 5-4 |   |
| LED Circuit | Isolated LEDs (see schematics) Connected LED Terminals | ON 7-9 | NONE NONE | ON 7-9 | |
| | Synchronous Single Color LED Connected LED Terminals | ON 7-9 | NONE NONE | OFF OPEN | |
| | Synchronous Bicolor LED Connected LED Terminals | Red 8-9 | NONE NONE | Green 8-7 | |
| M2123 Connected Power Terminals | DPDT | ON 2-3 5-6 | OFF OPEN | ON 2-1 5-4 |   |
| LED Circuit | Isolated LEDs (see schematics) Connected LED Terminals | ON 7-9 | ON 7-9 | ON 7-9 | |
| | Synchronous Single Color LED Connected LED Terminals | ON 7-9 | OFF OPEN | ON 7-9 | |
| | Synchronous Bicolor LED Connected LED Terminals | Red 8-9 | OFF OPEN | Green 8-7 | |

LED COLORS & SPECIFICATIONS

The electrical specifications shown are determined at a basic temperature of 25°C. LED circuit is isolated and requires an external power source. If the source voltage exceeds the rated voltage, a ballast resistor is required. The resistor value can be calculated by using the formula in Supplement Section. The LED is an integral part of the switch and not available separately. Bicolor LED is translucent white when unlit.

| | | Rockers | | | | Paddles | | | | Units |
|-----------------------------------|--------------|--------------|------|---------|--------------|--------------|---------|------|-----------|-------|
| | | Single Color | | Bicolor | Single Color | | Bicolor | | | |
| | | C | E | F | CF | C | E | F | CF | |
| Maximum Forward Current | I_{FM} | 25 | 30 | 30 | 25 | 25 | 30 | 25 | 30/25 | mA |
| Typical Forward Current | I_F | 20 | 20 | 20 | 20 | 20 | 20 | 20 | 20/20 | mA |
| Forward Voltage | V_F | 2.1 | 2.1 | 2.1 | 1.7/2.0 | 2.25 | 2.1 | 2.2 | 2.0/2.2 | V |
| Maximum Reverse Voltage | V_{RM} | 4 | 4 | 4 | — | 5 | 5 | 5 | — | V |
| Current Reduction Rate Above 25°C | ΔI_F | 0.33 | 0.40 | 0.40 | 0.33/0.33 | 0.33 | 0.40 | 0.33 | 0.43/0.38 | mA/°C |
| Ambient Temperature Range | | -10° ~ +55°C | | | | -25° ~ +70°C | | | | |

LED CIRCUIT, ROCKER, & MOUNTING TYPE COMBINATIONS

- R** Rocker with Isolated LED Circuit
- N** Rocker with Synchronous LED Circuit

Material: Polyamide
 Finish: Matte
 Color: Black

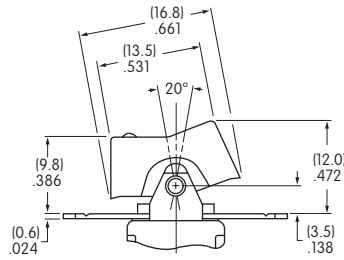

Flat Frame combines with Terminal codes 01, 02, & 03.

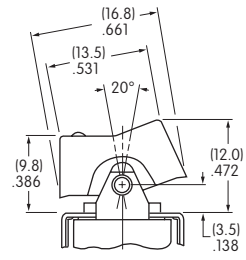

Bracket combines with Terminal code 13.

Maximum Panel Thickness .126" (3.2mm)

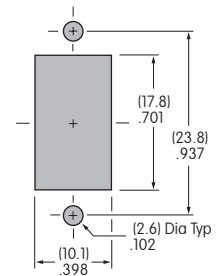

TYPICAL ROCKER SWITCH DIMENSIONS

Single Pole

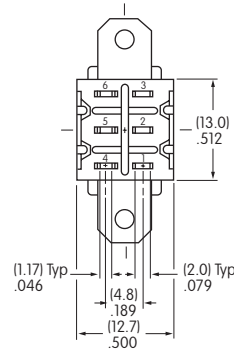
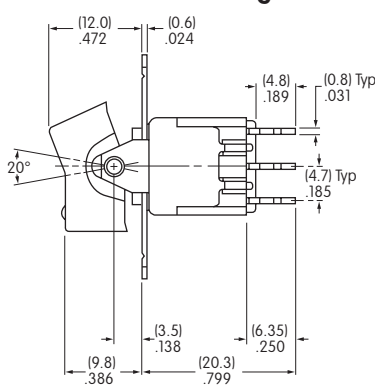
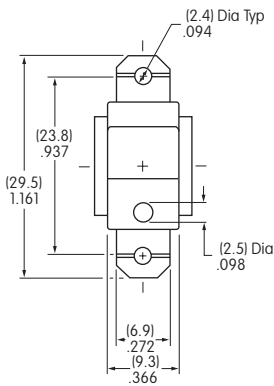

Single color LED switch does not have terminal 5.

Solder Lug



M2112NCFW01

Double Pole

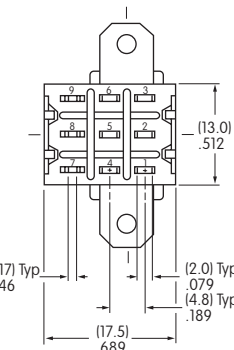
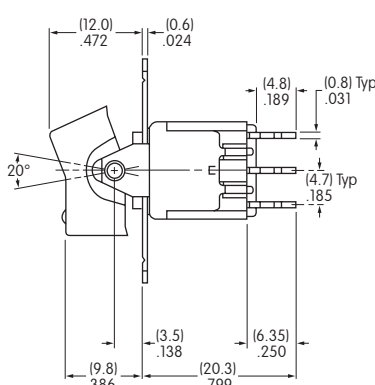
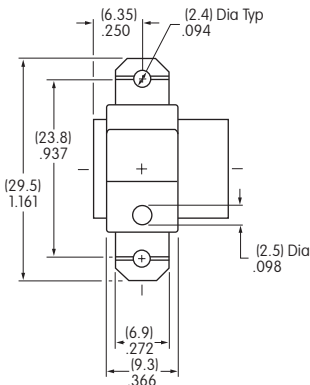

Single color LED switch does not have terminal 8.

Solder Lug



M2122NCFW01

Single Pole Only

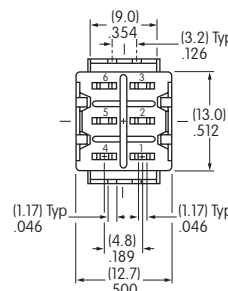
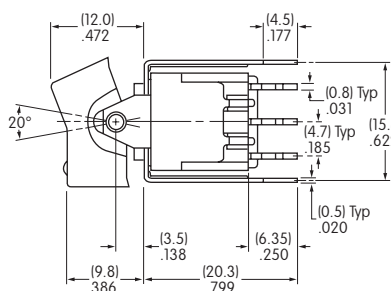
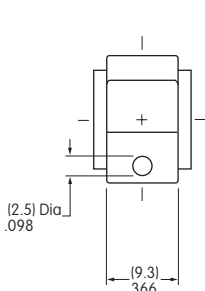

Single color LED switch does not have terminal 5. Silver contact material is standard.

Straight PC • Bracket

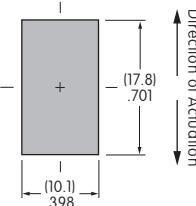

M2112NCFW13

LED CIRCUIT, PADDLE, & MOUNTING TYPE COMBINATIONS

P Paddle with Isolated LED Circuit

J Paddle with Synchronous LED Circuit

Maximum Panel Thickness
 .039" ~ .126" (1.0 ~ 3.2mm)
 without Bezel
 .039" ~ .098" (1.0 ~ 2.5mm)
 with Bezel

Maximum Panel Thickness
 .126" (3.2mm)

Material: Polyamide
 Finish: Matte
 Color: Black

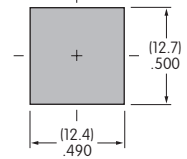
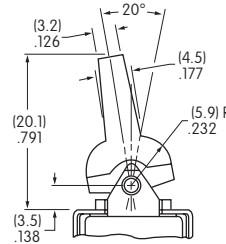
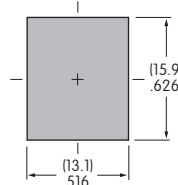
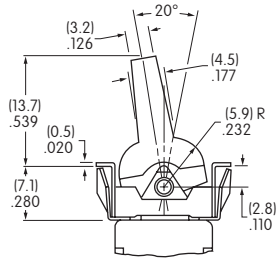

Snap-in combines with Terminal codes 01, 02, & 03

Bracket combines with Terminal code 13

TYPICAL PADDLE SWITCH DIMENSIONS

Solder Lug • Snap-in

Single Pole Only

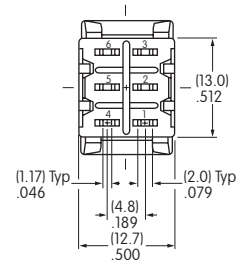
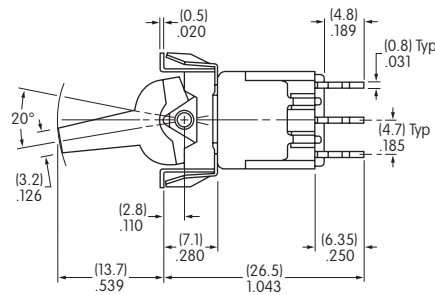
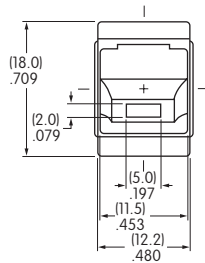

M2112JCFW01

Single color LED switch does not have terminal 5.

Straight PC • Bracket

Single Pole Only

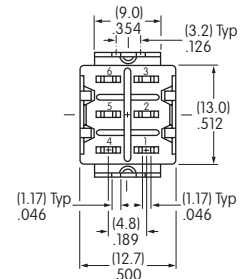
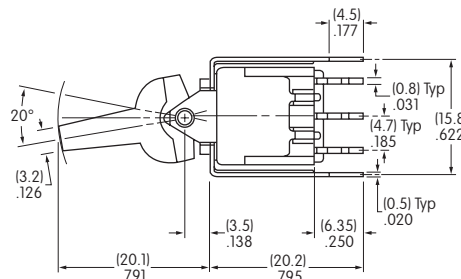
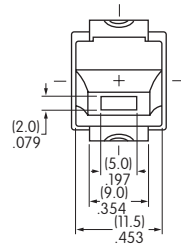

M2112JCFW13

Silver contact material is standard. Single color LED switch does not have terminal 5.

CONTACT MATERIALS & RATINGS

W Silver over Silver Power Level 6A @ 125V AC & 3A @ 250V AC

G Gold over Brass or Copper Logic Level 0.4VA maximum @ 28V AC/DC maximum

Complete explanation of operating range in Supplement section.

TERMINALS

01 Solder Lug with Turret LED Terminal

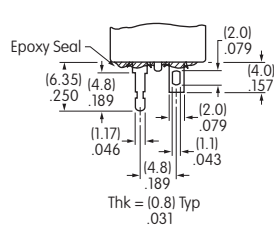

02 Quick Connect

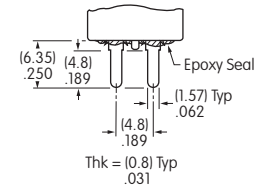

03 Straight PC with Turret LED Terminal

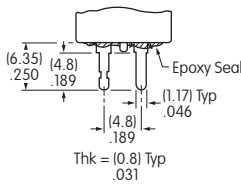

Single Pole

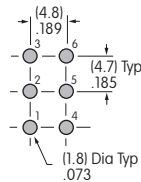

Single color LED & isolated bicolor LED switches do not have terminal 5.

Double Pole

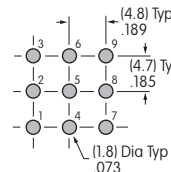

Single color LED & isolated bicolor LED switches do not have terminal 8.

13 Straight PC with Bracket & Turret LED Terminal

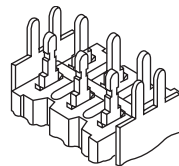

Single Pole

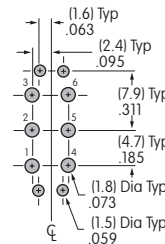

Single color LED & isolated bicolor LED switches do not have terminal 5.

OPTIONAL BEZEL & COLORS

AT2107 Bezel for Snap-in Panel Frame

Material: Polyamide

Finish: Matte

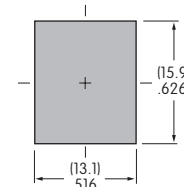
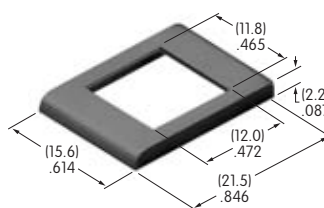

Colors Available:

- A** Black
- B** White
- E** Yellow
- F** Green
- G** Blue
- H** Gray

Toggles
Rockers
Pushbuttons
Illuminated PB
Programmable
Keylocks
Rotaries
Slides
Tactiles
Tilt
Touch
Indicators
Accessories
Supplement



Компания «ЭлектроПласт» предлагает заключение долгосрочных отношений при поставках импортных электронных компонентов на взаимовыгодных условиях!

Наши преимущества:

- Оперативные поставки широкого спектра электронных компонентов отечественного и импортного производства напрямую от производителей и с крупнейших мировых складов;
- Поставка более 17-ти миллионов наименований электронных компонентов;
- Поставка сложных, дефицитных, либо снятых с производства позиций;
- Оперативные сроки поставки под заказ (от 5 рабочих дней);
- Экспресс доставка в любую точку России;
- Техническая поддержка проекта, помощь в подборе аналогов, поставка прототипов;
- Система менеджмента качества сертифицирована по Международному стандарту ISO 9001;
- Лицензия ФСБ на осуществление работ с использованием сведений, составляющих государственную тайну;
- Поставка специализированных компонентов (Xilinx, Altera, Analog Devices, Intersil, Interpoint, Microsemi, Aeroflex, Peregrine, Syfer, Eurofarad, Texas Instrument, Miteq, Cobham, E2V, MA-COM, Hittite, Mini-Circuits, General Dynamics и др.);

Помимо этого, одним из направлений компании «ЭлектроПласт» является направление «Источники питания». Мы предлагаем Вам помощь Конструкторского отдела:

- Подбор оптимального решения, техническое обоснование при выборе компонента;
- Подбор аналогов;
- Консультации по применению компонента;
- Поставка образцов и прототипов;
- Техническая поддержка проекта;
- Защита от снятия компонента с производства.



Как с нами связаться

Телефон: 8 (812) 309 58 32 (многоканальный)

Факс: 8 (812) 320-02-42

Электронная почта: org@eplast1.ru

Адрес: 198099, г. Санкт-Петербург, ул. Калинина, дом 2, корпус 4, литера А.