

General Specifications

Electrical Capacity (Resistive Load)

Power Level (silver):	6A @ 125V AC or 3A @ 250V AC or 3A @ 30V DC	
Logic Level (gold):	0.4VA maximum @ 28V AC/DC maximum (Applicable Range 0.1mA ~ 0.1A @ 20mV ~ 28V)	
	Note: Find additional explanation of operating range in Supplement section.	

Other Ratings

Contact Resistance:	10 milliohms maximum for silver; 20 milliohms maximum for gold	
Insulation Resistance:	1,000 megohms minimum @ 500V DC	
Dielectric Strength:	1,000V AC minimum between contacts for 1 minute minimum; 1,500V AC minimum between contacts & case for 1 minute minimum	
Mechanical Life:	50,000 operations minimum	
Electrical Life:	25,000 operations minimum	
Nominal Operating Force:	On-to-On Position	Off-to-On Position
	Single Pole	3.19N
	Double Pole	4.41N
		3.92N
		7.06N
Angle of Throw:	20°	

Materials & Finishes

Bushing:	Brass with nickel plating
Housing:	Stainless steel
Mounting Bracket:	Steel with tin plating
Movable Contacts:	Silver alloy or silver alloy with gold plating
Stationary Contacts:	Silver with silver plating or copper or brass with gold plating
Lamp Contacts:	Phosphor bronze
Base:	Diallyl phthalate (UL94V-0)
Switch Terminals:	Copper with silver or gold plating
Lamp Terminals:	Brass with silver or gold plating

Environmental Data

Operating Temp Range:	-10°C through +55°C (+14°F through +131°F)
Humidity:	90 ~ 95% humidity for 96 hours @ 40°C (104°F)
Vibration:	10 ~ 55Hz with peak-to-peak amplitude of 1.5mm traversing the frequency range & returning in 1 minute; 3 right angled directions for 2 hours
Shock:	50G (490m/s ²) acceleration (tested in 6 right angled directions, with 5 shocks in each direction)

Installation

Mounting Torque:	1.47Nm (13 lb•in) for double nut; .67Nm (6 lb•in) for single nut
Soldering Time & Temp:	Wave Soldering (PC version): See Profile B in Supplement section. Manual Soldering: See Profile B in Supplement section. Note: Lever must be in center position while soldering.
Cleaning:	PC mountable device is not process sealed. Hand clean locally using alcohol based solution.

Standards & Certifications

Flammability Standards:	UL94V-0 base
UL:	File No. E44145 - Recognized only when ordered with marking on switch. Add "/U" to end of part number to order UL recognized switch. Single pole with synchronous circuits & single color LEDs & solder lug or PC recognized at 6A @ 125V AC.
CSA:	File No. 023535_0_000 - Certified only when ordered with marking on switch. Add "/C" to end of part number to order CSA certified switch. All single pole with synchronous circuits & single color LEDs certified at 6A @ 125V AC.

Distinctive Characteristics

Industry's first LED illumination at tip of toggle switches.

Single color LEDs of red, yellow, and green, plus bicolor red/green, to meet varied design requirements.

LEDs can operate independently from or synchronously with switching operation.

Antijamming feature to protect contacts from damage due to excessive downward force on the toggle.

High torque bushing prevents the bushing from rotating or separating from the metal frame during installation.

Stainless steel frame resists corrosion.

Silver contacts are of specially composed alloy for hardness.

High insulating barriers protect against crossover in double pole devices.

Terminals are molded in and epoxy sealed to lock out flux, dust, and other contaminants.

1,500V dielectric strength between switch contacts and case is accomplished by clinching the frame away from the terminals.



Actual Size



A

Toggles

Rockers

Pushbuttons

Illuminated PB

Programmable

Keylocks

Rotaries

Slides

Tactiles

Tilt

Touch

Indicators

Accessories

Supplement

TYPICAL SWITCH ORDERING EXAMPLE

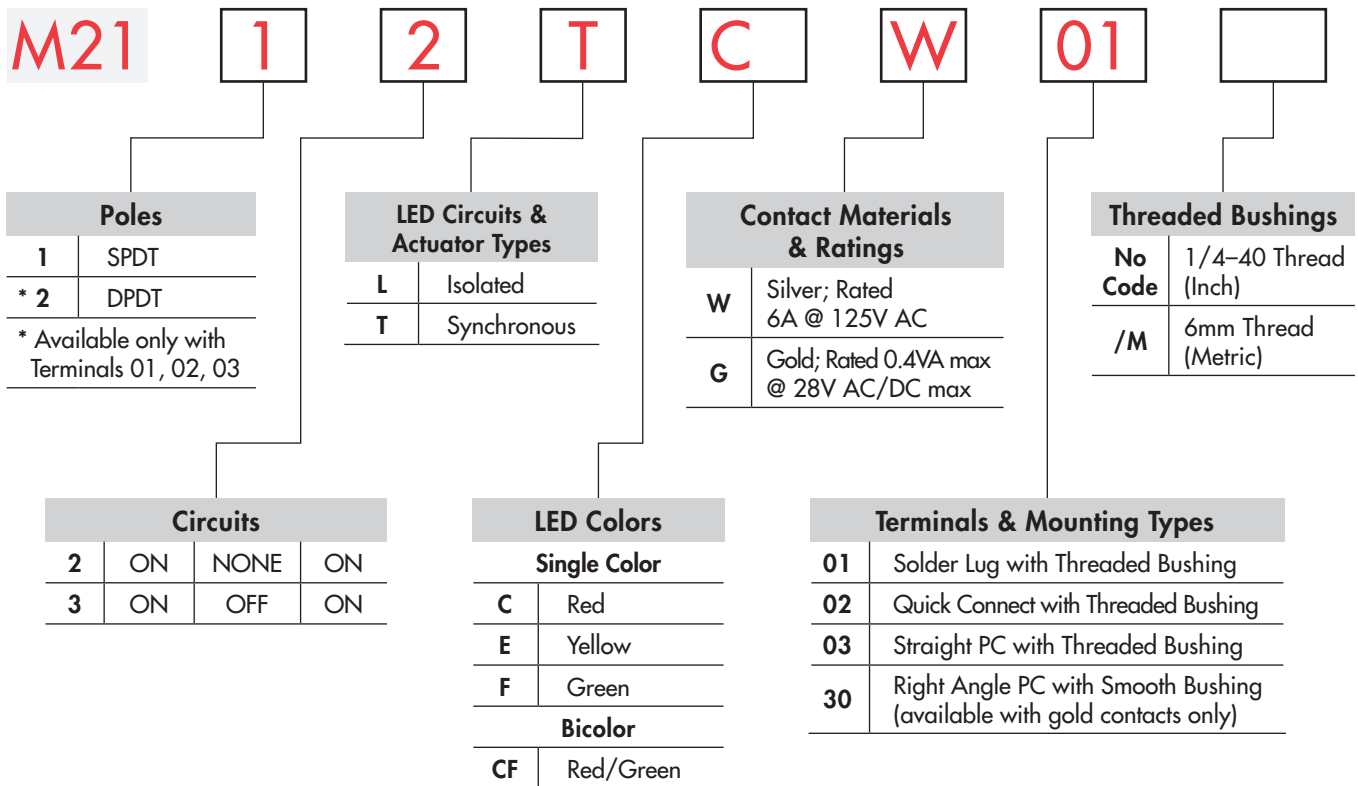

IMPORTANT:





Switches are supplied without UL & CSA marking unless specified.
UL & CSA recognized only when ordered with marking on the switch.
 Specific models, ratings, & ordering instructions are noted on the General Specifications page.

DESCRIPTION FOR TYPICAL ORDERING EXAMPLE

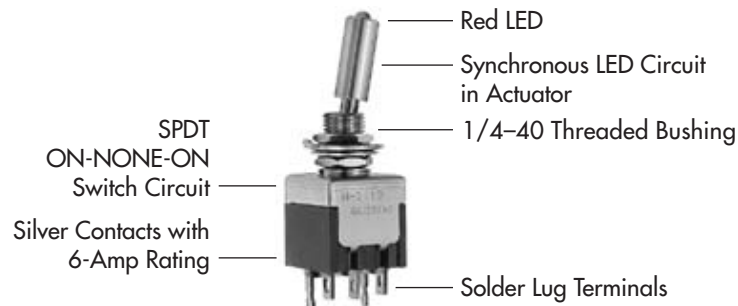
M2112TCW01

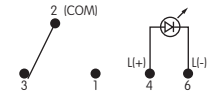
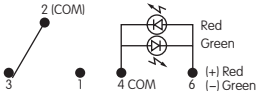
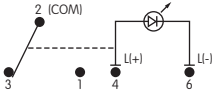
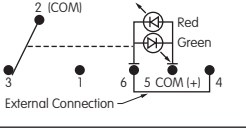

POLES & CIRCUITS & LED ILLUMINATION

Model	Pole & Throw	Toggle Position & Terminal Numbers			Schematics
		Down Keyway 	Center 	Up 	
M2112	SPDT	ON	NONE	ON	Notes: Terminal numbers are not actually on the switch. LEDs require an external power source. Isolated Single Color LED  Isolated Bicolor LED 
Connected Power Terminals		2-3	NONE	2-1	
LED Circuit					
	Isolated LEDs (see schematics) Connected LED Terminals	ON	NONE	ON	Synchronous Single Color LED  Synchronous Bicolor LED 
	Synchronous Single Color LED Connected LED Terminals	ON	NONE	OFF	
	Synchronous Bicolor LED Connected LED Terminals	Red	NONE	Green	
		4-6	NONE	4-6	
		4-6	NONE	OFF	
		Red	NONE	Green	
		5-6	NONE	5-4	
		4-6	ON	ON	
		4-6	OFF	ON	
		Red	OFF	Green	
		5-6	OPEN	5-4	
		4-6	ON	ON	
		4-6	OFF	ON	
		Red	OFF	Green	
		5-6	OPEN	5-4	
		4-6	ON	ON	
		4-6	OFF	ON	
		Red	OFF	Green	
		5-6	OPEN	5-4	
		4-6	ON	ON	
		4-6	OFF	ON	
		Red	OFF	Green	
		5-6	OPEN	5-4	
		4-6	ON	ON	
		4-6	OFF	ON	
		Red	OFF	Green	
		5-6	OPEN	5-4	
		4-6	ON	ON	
		4-6	OFF	ON	
		Red	OFF	Green	
		5-6	OPEN	5-4	
		4-6	ON	ON	
		4-6	OFF	ON	
		Red	OFF	Green	
		5-6	OPEN	5-4	
		4-6	ON	ON	
		4-6	OFF	ON	
		Red	OFF	Green	
		5-6	OPEN	5-4	
		4-6	ON	ON	
		4-6	OFF	ON	
		Red	OFF	Green	
		5-6	OPEN	5-4	
		4-6	ON	ON	
		4-6	OFF	ON	
		Red	OFF	Green	
		5-6	OPEN	5-4	
		4-6	ON	ON	
		4-6	OFF	ON	
		Red	OFF	Green	
		5-6	OPEN	5-4	
		4-6	ON	ON	
		4-6	OFF	ON	
		Red	OFF	Green	
		5-6	OPEN	5-4	
		4-6	ON	ON	
		4-6	OFF	ON	
		Red	OFF	Green	
		5-6	OPEN	5-4	
		4-6	ON	ON	
		4-6	OFF	ON	
		Red	OFF	Green	
		5-6	OPEN	5-4	
		4-6	ON	ON	
		4-6	OFF	ON	
		Red	OFF	Green	
		5-6	OPEN	5-4	
		4-6	ON	ON	
		4-6	OFF	ON	
		Red	OFF	Green	
		5-6	OPEN	5-4	
		4-6	ON	ON	
		4-6	OFF	ON	
		Red	OFF	Green	
		5-6	OPEN	5-4	
		4-6	ON	ON	
		4-6	OFF	ON	
		Red	OFF	Green	
		5-6	OPEN	5-4	
		4-6	ON	ON	
		4-6	OFF	ON	
		Red	OFF	Green	
		5-6	OPEN	5-4	
		4-6	ON	ON	
		4-6	OFF	ON	
		Red	OFF	Green	
		5-6	OPEN	5-4	
		4-6	ON	ON	
		4-6	OFF	ON	
		Red	OFF	Green	
		5-6	OPEN	5-4	
		4-6	ON	ON	
		4-6	OFF	ON	
		Red	OFF	Green	
		5-6	OPEN	5-4	
		4-6	ON	ON	
		4-6	OFF	ON	
		Red	OFF	Green	
		5-6	OPEN	5-4	
		4-6	ON	ON	
		4-6	OFF	ON	
		Red	OFF	Green	
		5-6	OPEN	5-4	
		4-6	ON	ON	
		4-6	OFF	ON	
		Red	OFF	Green	
		5-6	OPEN	5-4	
		4-6	ON	ON	
		4-6	OFF	ON	
		Red	OFF	Green	
		5-6	OPEN	5-4	
		4-6	ON	ON	
		4-6	OFF	ON	
		Red	OFF	Green	
		5-6	OPEN	5-4	
		4-6	ON	ON	
		4-6	OFF	ON	
		Red	OFF	Green	
		5-6	OPEN	5-4	
		4-6	ON	ON	
		4-6	OFF	ON	
		Red	OFF	Green	
		5-6	OPEN	5-4	
		4-6	ON	ON	
		4-6	OFF	ON	
		Red	OFF	Green	
		5-6	OPEN	5-4	
		4-6	ON	ON	
		4-6	OFF	ON	
		Red	OFF	Green	
		5-6	OPEN	5-4	
		4-6	ON	ON	
		4-6	OFF	ON	
		Red	OFF	Green	
		5-6	OPEN	5-4	
		4-6	ON	ON	
		4-6	OFF	ON	
		Red	OFF	Green	
		5-6	OPEN	5-4	
		4-6	ON	ON	
		4-6	OFF	ON	
		Red	OFF	Green	
		5-6	OPEN	5-4	
		4-6	ON	ON	
		4-6	OFF	ON	
		Red	OFF	Green	
		5-6	OPEN	5-4	
		4-6	ON	ON	
		4-6	OFF	ON	
		Red	OFF	Green	
		5-6	OPEN	5-4	
		4-6	ON	ON	
		4-6	OFF	ON	
		Red	OFF	Green	
		5-6	OPEN	5-4	
		4-6	ON	ON	
		4-6	OFF	ON	
		Red	OFF	Green	
		5-6	OPEN	5-4	
		4-6	ON	ON	
		4-6	OFF	ON	
		Red	OFF	Green	
		5-6	OPEN	5-4	
		4-6	ON	ON	
		4-6	OFF	ON	
		Red	OFF	Green	
		5-6	OPEN	5-4	
		4-6	ON	ON	
		4-6	OFF	ON	
		Red	OFF	Green	
		5-6	OPEN	5-4	
		4-6	ON	ON	
		4-6	OFF	ON	
		Red	OFF	Green	
		5-6	OPEN	5-4	
		4-6	ON	ON	
		4-6	OFF	ON	
		Red	OFF	Green	
		5-6	OPEN	5-4	
		4-6	ON	ON	
		4-6	OFF	ON	
		Red	OFF	Green	
		5-6	OPEN	5-4	
		4-6	ON	ON	
		4-6	OFF	ON	
		Red	OFF	Green	
		5-6	OPEN	5-4	
		4-6	ON	ON	
		4-6	OFF	ON	
		Red	OFF	Green	
		5-6	OPEN	5-4	
		4-6	ON	ON	
		4-6	OFF	ON	
		Red	OFF	Green	
		5-6	OPEN	5-4	
		4-6	ON	ON	
		4-6	OFF	ON	
		Red	OFF	Green	
		5-6	OPEN	5-4	
		4-6	ON	ON	
		4-6	OFF	ON	
		Red	OFF	Green	
		5-6	OPEN	5-4	
		4-6	ON	ON	
		4-6	OFF	ON	
		Red	OFF	Green	
		5-6	OPEN	5-4	
		4-6	ON	ON	
		4-6	OFF	ON	
		Red	OFF	Green	
		5-6	OPEN	5-4	
		4-6	ON	ON	
		4-6	OFF	ON	
		Red	OFF	Green	
		5-6	OPEN	5-4	
		4-6	ON	ON	
		4-6	OFF	ON	
		Red	OFF	Green	
		5-6	OPEN	5-4	
		4-6	ON	ON	
		4-6	OFF	ON	
		Red	OFF	Green	
		5-6	OPEN	5-4	
		4-6	ON	ON	
		4-6	OFF	ON	
		Red	OFF	Green	
		5-6	OPEN	5-4	
		4-6	ON	ON	
		4-6	OFF	ON	
		Red	OFF	Green	
		5-6	OPEN	5-4	
		4-6	ON	ON	
		4-6	OFF	ON	
		Red	OFF	Green	
		5-6	OPEN	5-4	
		4-6	ON	ON	
		4-6	OFF	ON	
		Red	OFF	Green	
		5-6	OPEN	5-4	
		4-6	ON	ON	
		4-6	OFF	ON	
		Red	OFF	Green	
		5-6	OPEN	5-4	
		4-6	ON	ON	
		4-6	OFF	ON	
		Red	OFF	Green	
		5-6	OPEN	5-4	
		4-6	ON	ON	
		4-6	OFF	ON	
		Red	OFF	Green	
		5-6	OPEN	5-4	
		4-6	ON	ON	
		4-6	OFF	ON	
		Red	OFF	Green	
		5-6	OPEN	5-4	
		4-6	ON	ON	
		4-6	OFF	ON	
		Red	OFF	Green	

LED CIRCUIT, TOGGLE, & MOUNTING TYPE COMBINATIONS

L Toggle with Isolated LED Circuit

T Toggle with Synchronous LED Circuit

Finish: Brushed aluminum

Standard Hardware: 2 AT513H Hex Nuts, 1 AT507H Locking Ring, 1 AT509 Lockwasher Standard & optional hardware details in Accessories & Hardware section.



Threaded Bushing combines with Terminal codes 01, 02, & 03.



Smooth Bushing combines with Terminal code 30.

Max. Panel Thickness with Standard Hardware .102" (2.6mm)



Max. Panel Thickness without Locking Ring .134" (3.4mm)



TYPICAL SWITCH DIMENSIONS

Solder Lug



M2112TCFW01

Single Pole

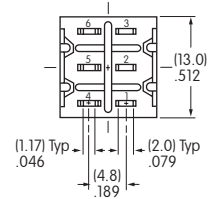

Single color LED switch does not have terminal 5.

Solder Lug



M2122TCFW01

Double Pole



Single color LED switch does not have terminal 8.

Right Angle PC



M2112TCFG30

Single Pole Only

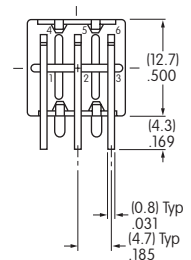

Single color LED switch does not have terminal 5.

Gold contact material only

Toggles
 Rockers
 Pushbuttons
 Illuminated PB
 Programmable
 Keylocks
 Rotaries
 Slides
 Tactiles
 Tilt
 Touch
 Indicators
 Accessories
 Supplement

CONTACT MATERIALS & RATINGS

W

Silver over Silver

Power Level

6A @ 125V AC & 3A @ 250V AC

G

Gold over Brass or Copper

Logic Level

0.4VA maximum @ 28V AC/DC maximum

Complete explanation of operating range in Supplement section.

TERMINALS

01

Solder Lug with Turret LED Terminal



02

Quick Connect

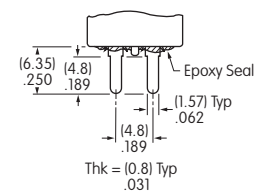

03

Straight PC with Turret LED Terminal



Single Pole

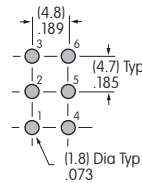

Single color LED & isolated bicolor LED switches do not have terminal 5.

Double Pole

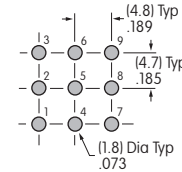

Single color LED & isolated bicolor LED switches do not have terminal 8.

30

Right Angle PC

LED terminals only available in brass with silver plating



Single Pole



Single color LED & isolated bicolor LED switches do not have terminal 5.

STANDARD MOUNTING HARDWARE

AT513H

Hexagon Nuts (2 per switch)

Material: Brass with nickel plating

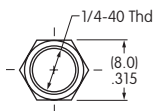

AT507H

Locking Ring (1 per switch)

Material: Steel with chromate over zinc

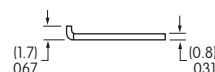
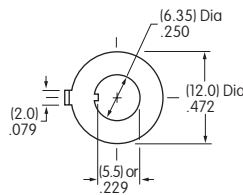

AT509

Lockwasher (1 per switch)

Material: Steel with chromate over zinc



Optional Hardware: Knurled nuts, dress nuts, and ON-OFF plates are available; see details in Accessories & Hardware section.

General Specifications

Toggle

Rockers

Pushbuttons

Illuminated PB

Programmable

Keylocks

Rotaries

Slides

Tactiles

Tilt

Touch

Indicators

Accessories

Supplement

B Electrical Capacity (Resistive Load)

Power Level (silver): 6A @ 125V AC or 3A @ 250V AC or 3A @ 30V DC

Logic Level (gold): 0.4VA maximum @ 28V AC/DC maximum
(Applicable Range 0.1mA ~ 0.1A @ 20mV ~ 28V)

Note: Find additional explanation of operating range in Supplement section.

Other Ratings

Contact Resistance: 10 milliohms maximum for silver; 20 milliohms maximum for gold

Insulation Resistance: 1,000 megohms minimum @ 500V DC

Dielectric Strength: 1,000V AC minimum between contacts for 1 minute minimum;
1,500V AC minimum between contacts & case for 1 minute minimum

Mechanical Life: 50,000 operations minimum

Electrical Life: 25,000 operations minimum

Nominal Operating Force:		On-to-On Position		Off-to-On Position	
Paddles	Single Pole	3.19N		3.92N	
	Double Pole	4.41N		7.06N	
Rockers	Single Pole	6.37N		9.80N	
	Double Pole	13.73N		17.65N	

Angle of Throw: 20°

Materials & Finishes

Housing: Stainless steel

Mounting Bracket: Steel with tin plating

Movable Contacts: Silver alloy or silver alloy with gold plating

Stationary Contacts: Silver with silver plating or copper or brass with gold plating

Lamp Contacts: Phosphor bronze

Base: Diallyl phthalate (UL94V-0)

Switch Terminals: Copper with silver or gold plating

Lamp Terminals: Brass with silver or gold plating

Environmental Data

Operating Temp Range: -10°C through +55°C (+14°F through +131°F) for rockers
-25°C through +70°C (-13°F through +158°F) for paddles

Humidity: 90 ~ 95% humidity for 96 hours @ 40°C (104°F)

Vibration: 10 ~ 55Hz with peak-to-peak amplitude of 1.5mm traversing the frequency range & returning in 1 minute; 3 right angled directions for 2 hours

Shock: 50G (490m/s²) acceleration (tested in 6 right angled directions, with 5 shocks in each direction)

Installation

Soldering Time & Temp: Wave Soldering (PC version): See Profile B in Supplement section.

Manual Soldering: See Profile B in Supplement section.

Note: Lever must be in center position while soldering.

Cleaning: PC mountable device is not process sealed. Hand clean locally using alcohol based solution.

Standards & Certifications

Flammability Standards: UL94V-0 base

UL: File No. E44145 - Recognized only when ordered with marking on switch.

Add "/U" before dash in part number to order UL recognized switch.

Single pole rockers with synchronous circuits & single color LEDs & solder lug or PC recognized at 6A @ 125V AC.

CSA: File No. 023535_0_000 - Certified only when ordered with marking on switch.

Add "/C" before dash in part number to order CSA certified switch.

All single pole rockers with synchronous circuits & single color LEDs certified at 6A @ 125V AC.

TYPICAL SWITCH ORDERING EXAMPLE

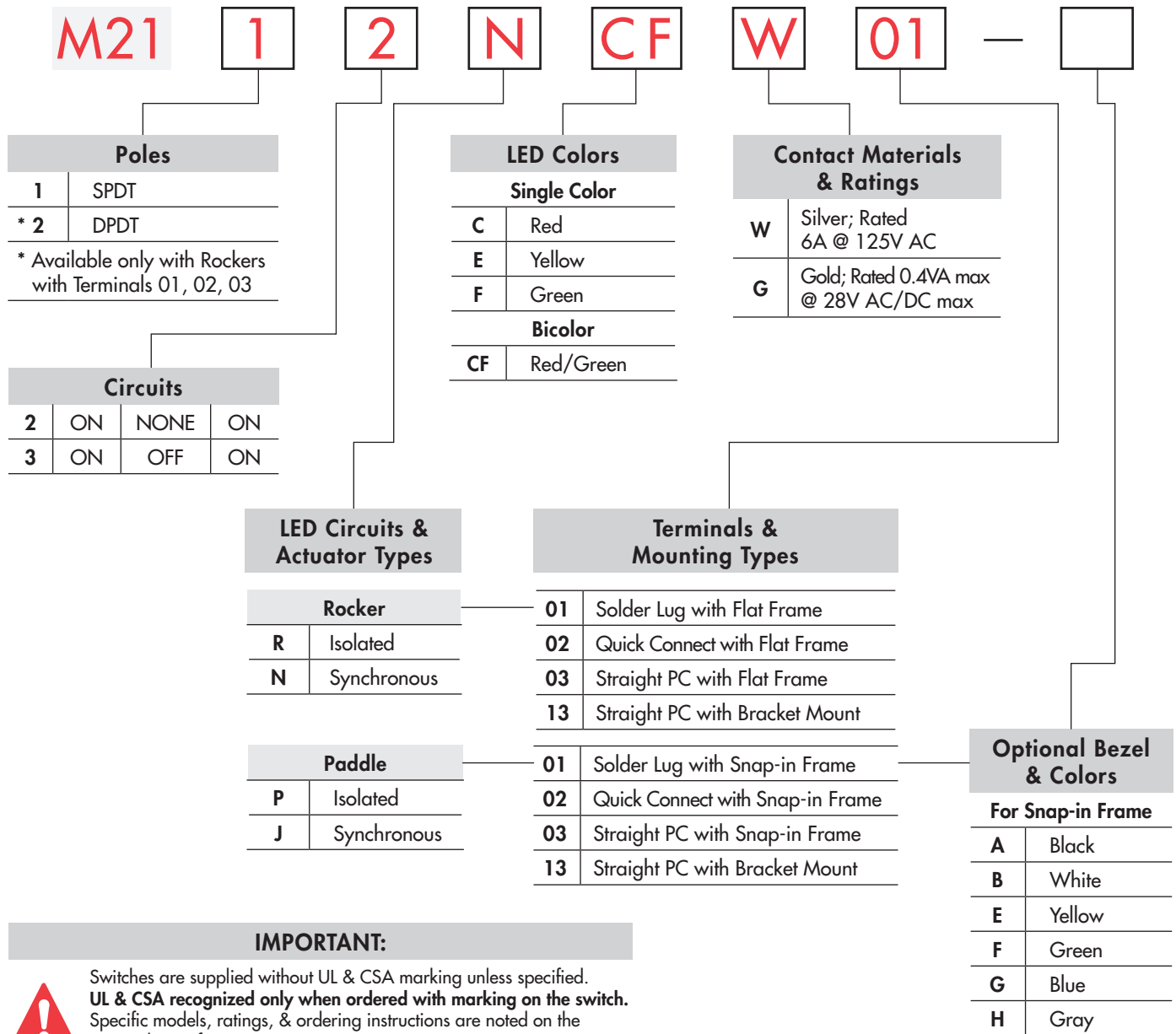

IMPORTANT:





Switches are supplied without UL & CSA marking unless specified. **UL & CSA recognized only when ordered with marking on the switch.** Specific models, ratings, & ordering instructions are noted on the General Specifications page.

DESCRIPTION FOR TYPICAL ORDERING EXAMPLE

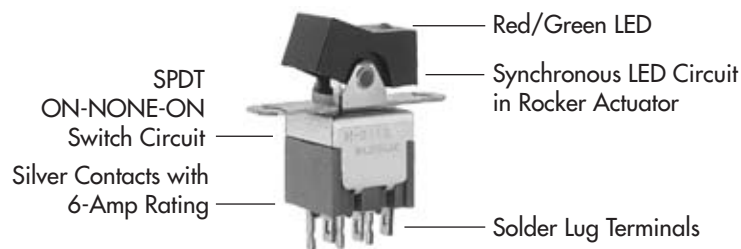
M2112NCFW01

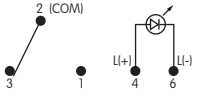
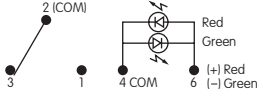
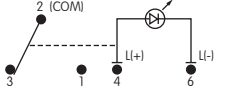
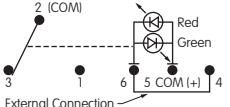
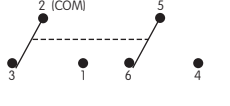
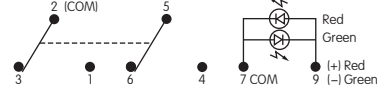
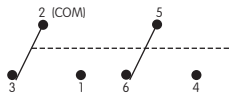
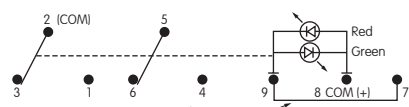

POLES & CIRCUITS & LED ILLUMINATION

Model	Pole & Throw	Toggle Position & Terminal Numbers			Schematics
		Down 	Center 	Up 	
M2112 Connected Power Terminals	SPDT	ON 2-3	NONE NONE	ON 2-1	Notes: Terminal numbers are not actually on the switch. LEDs require an external power source.  
LED Circuit	Isolated LEDs (see schematics) Connected LED Terminals	ON 4-6	NONE NONE	ON 4-6	
	Synchronous Single Color LED Connected LED Terminals	ON 4-6	NONE NONE	OFF OPEN	
	Synchronous Bicolor LED Connected LED Terminals	Red 5-6	NONE NONE	Green 5-4	
M2113 Connected Power Terminals	SPDT	ON 2-3	OFF OPEN	ON 2-1	 
LED Circuit	Isolated LEDs (see schematics) Connected LED Terminals	ON 4-6	ON 4-6	ON 4-6	
	Synchronous Single Color LED Connected LED Terminals	ON 4-6	OFF OPEN	ON 4-6	
	Synchronous Bicolor LED Connected LED Terminals	Red 5-6	OFF OPEN	Green 5-4	
M2122 Connected Power Terminals	DPDT	ON 2-3 5-6	NONE NONE	ON 2-1 5-4	 
LED Circuit	Isolated LEDs (see schematics) Connected LED Terminals	ON 7-9	NONE NONE	ON 7-9	
	Synchronous Single Color LED Connected LED Terminals	ON 7-9	NONE NONE	OFF OPEN	
	Synchronous Bicolor LED Connected LED Terminals	Red 8-9	NONE NONE	Green 8-7	
M2123 Connected Power Terminals	DPDT	ON 2-3 5-6	OFF OPEN	ON 2-1 5-4	 
LED Circuit	Isolated LEDs (see schematics) Connected LED Terminals	ON 7-9	ON 7-9	ON 7-9	
	Synchronous Single Color LED Connected LED Terminals	ON 7-9	OFF OPEN	ON 7-9	
	Synchronous Bicolor LED Connected LED Terminals	Red 8-9	OFF OPEN	Green 8-7	

LED COLORS & SPECIFICATIONS

The electrical specifications shown are determined at a basic temperature of 25°C. LED circuit is isolated and requires an external power source. If the source voltage exceeds the rated voltage, a ballast resistor is required. The resistor value can be calculated by using the formula in Supplement Section. The LED is an integral part of the switch and not available separately. Bicolor LED is translucent white when unlit.

		Rockers				Paddles				Units
		Single Color		Bicolor	Single Color		Bicolor			
		C	E	F	CF	C	E	F	CF	
Maximum Forward Current	I_{FM}	25	30	30	25	25	30	25	30/25	mA
Typical Forward Current	I_F	20	20	20	20	20	20	20	20/20	mA
Forward Voltage	V_F	2.1	2.1	2.1	1.7/2.0	2.25	2.1	2.2	2.0/2.2	V
Maximum Reverse Voltage	V_{RM}	4	4	4	—	5	5	5	—	V
Current Reduction Rate Above 25°C	ΔI_F	0.33	0.40	0.40	0.33/0.33	0.33	0.40	0.33	0.43/0.38	mA/°C
Ambient Temperature Range		-10° ~ +55°C				-25° ~ +70°C				

LED CIRCUIT, ROCKER, & MOUNTING TYPE COMBINATIONS

- R** Rocker with Isolated LED Circuit
- N** Rocker with Synchronous LED Circuit

Material: Polyamide
 Finish: Matte
 Color: Black



Flat Frame combines with Terminal codes 01, 02, & 03.



Bracket combines with Terminal code 13.

Maximum Panel Thickness
 .126" (3.2mm)



TYPICAL ROCKER SWITCH DIMENSIONS

Single Pole

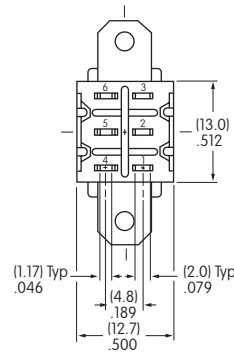
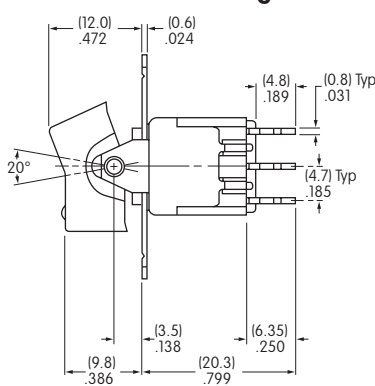
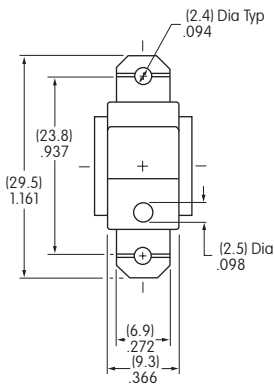

Single color LED switch does not have terminal 5.

Solder Lug



M2112NCFW01

Double Pole

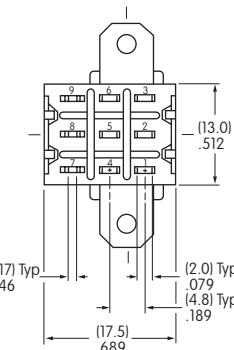
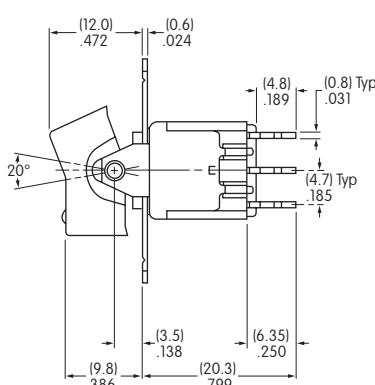
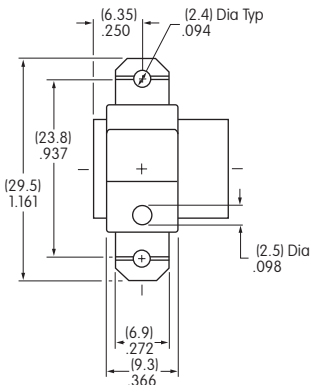

Single color LED switch does not have terminal 8.

Solder Lug



M2122NCFW01

Single Pole Only

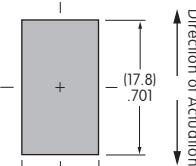

Single color LED switch does not have terminal 5. Silver contact material is standard.

Straight PC • Bracket



M2112NCFW13

LED CIRCUIT, PADDLE, & MOUNTING TYPE COMBINATIONS

P Paddle with Isolated LED Circuit

J Paddle with Synchronous LED Circuit

Maximum Panel Thickness
.039" ~ .126" (1.0 ~ 3.2mm)
without Bezel

Maximum Panel Thickness
.039" ~ .098" (1.0 ~ 2.5mm)
with Bezel

Maximum Panel Thickness
.126" (3.2mm)

Material: Polyamide
Finish: Matte
Color: Black

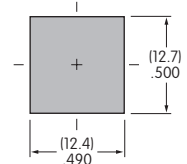
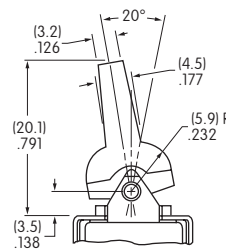
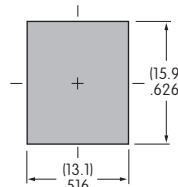
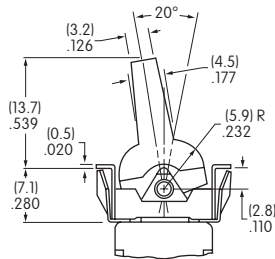

Snap-in combines with Terminal codes 01, 02, & 03

Bracket combines with Terminal code 13

TYPICAL PADDLE SWITCH DIMENSIONS

Solder Lug • Snap-in

Single Pole Only

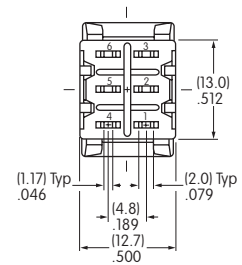
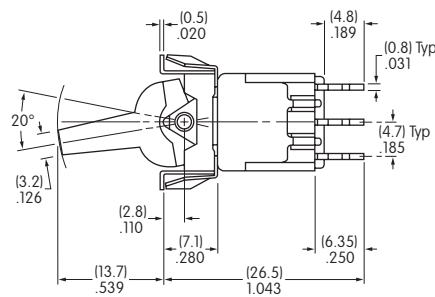
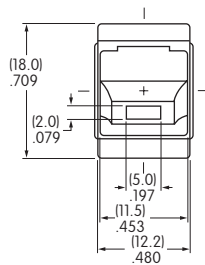

M2112JCFW01

Single color LED switch does not have terminal 5.

Straight PC • Bracket

Single Pole Only

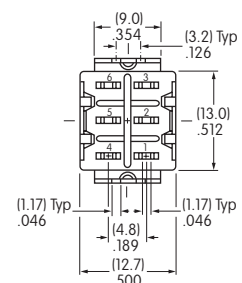
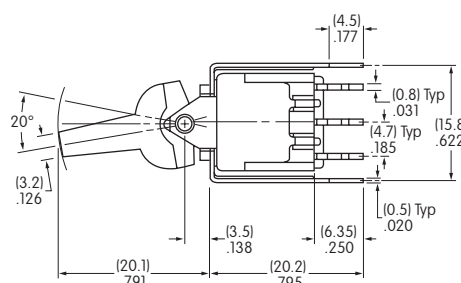
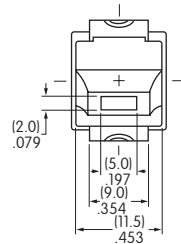

M2112JCFW13

Silver contact material is standard. Single color LED switch does not have terminal 5.

CONTACT MATERIALS & RATINGS

W Silver over Silver Power Level 6A @ 125V AC & 3A @ 250V AC

G Gold over Brass or Copper Logic Level 0.4VA maximum @ 28V AC/DC maximum
 Complete explanation of operating range in Supplement section.

TERMINALS

01 Solder Lug with Turret LED Terminal

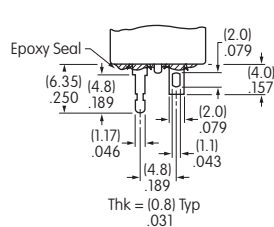

02 Quick Connect

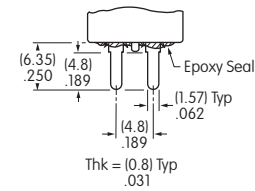

03 Straight PC with Turret LED Terminal

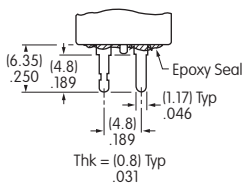

Single Pole

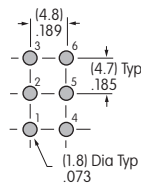

Single color LED & isolated bicolor LED switches do not have terminal 5.

Double Pole

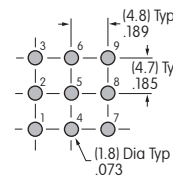

Single color LED & isolated bicolor LED switches do not have terminal 8.

13 Straight PC with Bracket & Turret LED Terminal

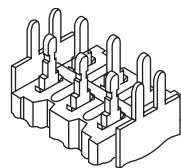

Single Pole

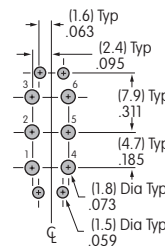

Single color LED & isolated bicolor LED switches do not have terminal 5.

OPTIONAL BEZEL & COLORS

AT2107 Bezel for Snap-in Panel Frame

Material: Polyamide

Finish: Matte

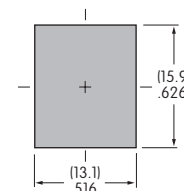
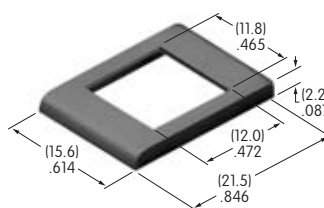

Colors Available:

- A** Black
- B** White
- E** Yellow
- F** Green
- G** Blue
- H** Gray



Компания «ЭлектроПласт» предлагает заключение долгосрочных отношений при поставках импортных электронных компонентов на взаимовыгодных условиях!

Наши преимущества:

- Оперативные поставки широкого спектра электронных компонентов отечественного и импортного производства напрямую от производителей и с крупнейших мировых складов;
- Поставка более 17-ти миллионов наименований электронных компонентов;
- Поставка сложных, дефицитных, либо снятых с производства позиций;
- Оперативные сроки поставки под заказ (от 5 рабочих дней);
- Экспресс доставка в любую точку России;
- Техническая поддержка проекта, помощь в подборе аналогов, поставка прототипов;
- Система менеджмента качества сертифицирована по Международному стандарту ISO 9001;
- Лицензия ФСБ на осуществление работ с использованием сведений, составляющих государственную тайну;
- Поставка специализированных компонентов (Xilinx, Altera, Analog Devices, Intersil, Interpoint, Microsemi, Aeroflex, Peregrine, Syfer, Eurofarad, Texas Instrument, Miteq, Cobham, E2V, MA-COM, Hittite, Mini-Circuits, General Dynamics и др.);

Помимо этого, одним из направлений компании «ЭлектроПласт» является направление «Источники питания». Мы предлагаем Вам помощь Конструкторского отдела:

- Подбор оптимального решения, техническое обоснование при выборе компонента;
- Подбор аналогов;
- Консультации по применению компонента;
- Поставка образцов и прототипов;
- Техническая поддержка проекта;
- Защита от снятия компонента с производства.



Как с нами связаться

Телефон: 8 (812) 309 58 32 (многоканальный)

Факс: 8 (812) 320-02-42

Электронная почта: org@eplast1.ru

Адрес: 198099, г. Санкт-Петербург, ул. Калинина, дом 2, корпус 4, литера А.