

## Audio Jack Detector with Send / End Detect

### DESCRIPTION

The DG2592 is an audio jack detector and pop noise control switch IC. It integrates the circuits necessary to detect the presence of a stereo headset with a microphone and send / end control button.

When there is no ear phone detected, the DG2592 connects the microphone bias line to ground through the MIC pin. The DG2592 also gives a logic high signal to the baseband controller through the DET pin.

The DG2592 senses the DC levels at both L\_Detect and GND\_Detect. When an ear phone is plugged in, the voltage at both pins will go low. The DG2592 will indicate the presence of the ear phone by pulling DET low and the MIC switch will turn off.

The DG2592 is available in small miniQFN10 of 1.4 mm x 1.8 mm x 0.55 mm and ultra thin UTMQFN10 of 0.35 mm thickness.

### FEATURES

- Wide operating voltage range: 1.6 V to 5.5 V
- Low quiescent current of 10  $\mu$ A, max. at  $V_{DD} = 1.8$  V
- Integrated sense comparator for audio L of  $1.4$  V  $\pm$  5 % threshold
- 1.2  $\Omega$ /max. MIC bias switch provides quick discharge and clamping
- ESD Protected
  - Human body model > 8 kV
  - Charged device model > 2 kV
  - IEC 61000-4-2 air discharge > 15 kV
  - IEC 61000-4-2 contact discharge > 8 kV
- Ultra thin and compact miniQFN10 and UTMQFN10
- Material categorization: for definitions of compliance please see [www.vishay.com/doc?99912](http://www.vishay.com/doc?99912)



**RoHS**  
COMPLIANT  
HALOGEN  
**FREE**

### APPLICATIONS

- Cellular phones
- Tablet devices
- Portable media players
- Digital cameras

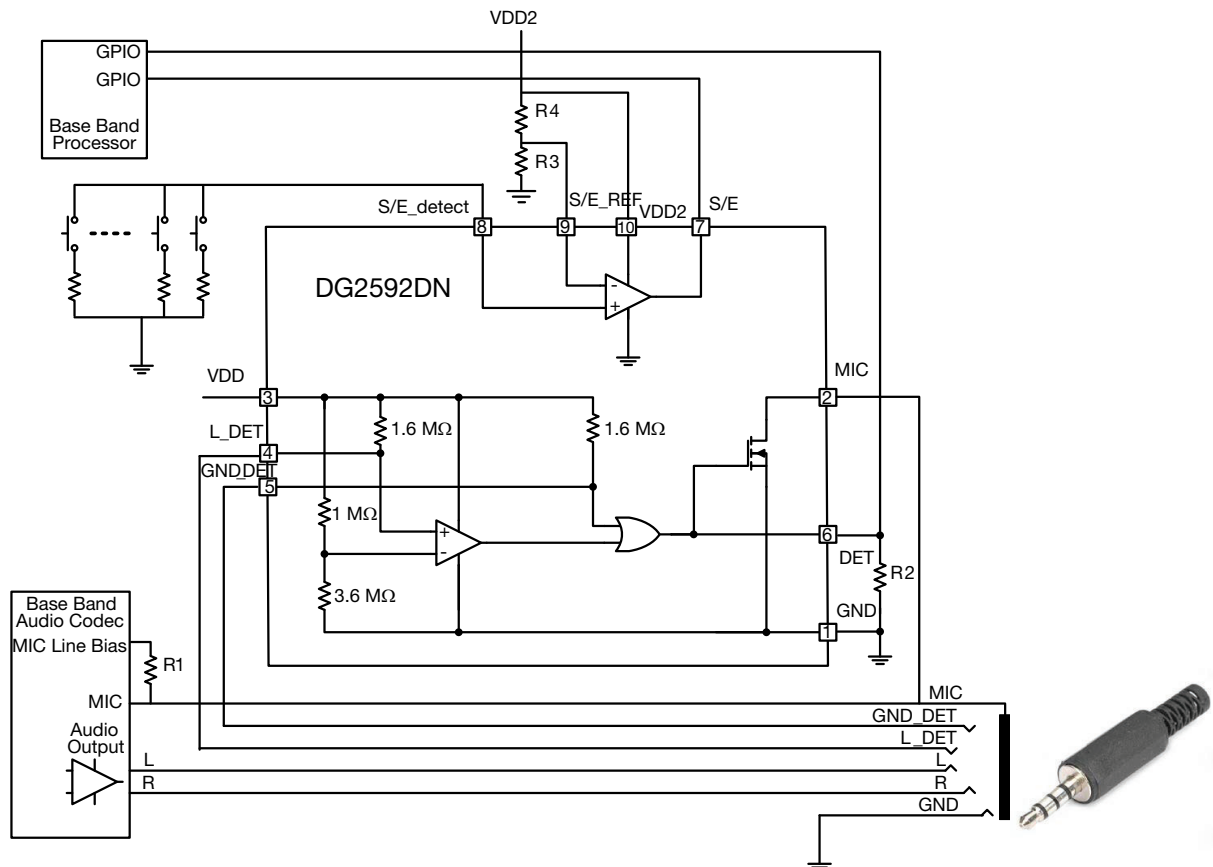
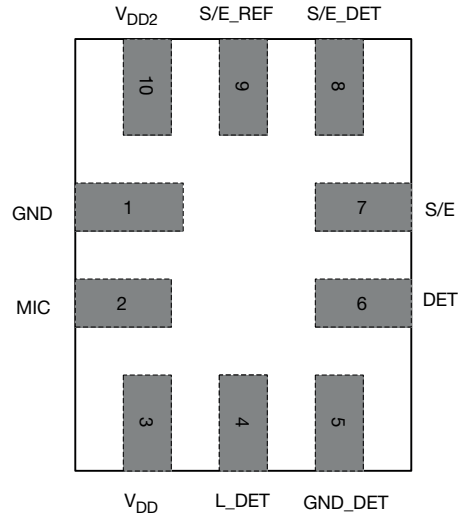
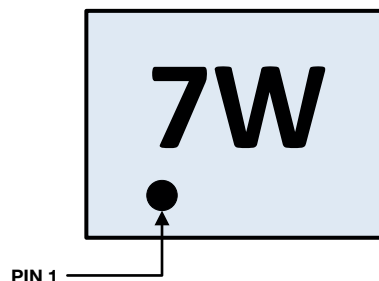

Fig. 1 - Typical Application Circuit

**PACKAGE OUTLINE**

**Fig. 2 - Device Pin Out miniQFN10 Top View, Pin 1 Dot Marking is on Top of the Device**

PIN DESCRIPTION			
PIN#	NAME	TYPE	FUNCTION
1	GND	Power	Ground
2	MIC	Output	Microphone bias switch input
3	V <sub>DD</sub>	Power	Power supply for ear jack plug in detection circuit. A bypass capacitor of 0.1 $\mu$ F is recommended as close as possible to this pin
4	L_DET	Input	Connected to L_DET pin at audio jack
5	GND_DET	Input	Connect to GND_DET pin at audio jack
6	DET	Output	Detect logic output connected to baseband controller
7	S/E	Output	S/E detect comparator output
8	S/E_DET	Input	Non-inverting input of S/E press detection comparator
9	S/E_REF	Input	Inverting input of S/E press detection comparator. External voltage is provided as press detection reference threshold
10	V <sub>DD2</sub>	Power	Power supply pin for the S/E detection circuit. A bypass capacitor of 0.1 $\mu$ F is recommended as close as possible to this pin

ORDERING INFORMATION					
PART NUMBER	FUNCTION	TEMPERATURE RANGE	PACKAGE	SIZE	REEL QUANTITY
DG2592DN-T1-GE4	Audio jack detector with S/E detect	-40 °C to 85 °C	miniQFN-10	1.4 mm x 1.8 mm x 0.55 mm	3000
DG2592DN1-T1-GE4			UTMQFN-10	1.4 mm x 1.8 mm x 0.35 mm	3000

**DEVICE MARKING**

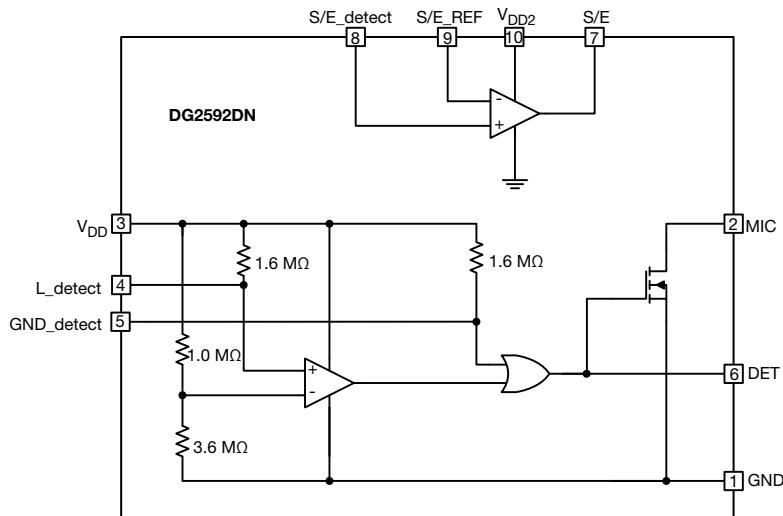
7 = DG2592 Marking Code, W = Date / Lot Traceability Code

**Fig. 3 - Functional Block Diagram**

TRUTH TABLE				
INPUTS		OUTPUTS		AUDIO JACK
L_DET	GND_DET	DET	MIC	
0	0	Low	High	Detected
1	0	High	Low	Not detected
0	1	High	Low	Not detected
1	1	High	Low	Not detected

ABSOLUTE MAXIMUM RATINGS				
PINS OR PARAMETERS	CONDITIONS	LIMITS	UNIT	
$V_{DD}$ , $V_{DD2}$	Reference to GND	-0.3 to 6	V	
L_Detect, GND_Detect, DET	Reference to GND	-0.3 V to $V_{DD}$		
S/E_DET, S/E_REF, S/E	Reference to GND	-0.3 V to $V_{DD2}$		
MIC		-0.3 to 6		
Storage Temperature		-65 to +150	°C	
MSL	Moisture sensitivity level (JEDEC® J-STD-020)	1	Level	
$I_{MIC}$	Switch DC current	200	mA	
$I_{MICPEAK}$	Switch peak current (pulsed at 1 ms, < 10 % duty cycle)	500		
Latch Up Current	JESD78	± 600		
ESD	Human body model; ANSI / ESDA / JEDEC JS-001		> 8000	V
	Charged device model; JESD22-C101		> 2000	
	Machine model; JESD22-A115		> 400	
	IEC61000-2-4, level 4			
		Contact	> 8000	
	L_DET, GND_DET, MIC and GND pins	Air	> 15 000	
RECOMMENDED OPERATING CONDITION				
$V_{DD}$ , $V_{DD2}$		1.6 to 5.5	V	
Ear Jack Detection Input Pins		0 to $V_{DD}$	V	
S/E Press Detection Input Pins		0 to $V_{DD2}$	V	
MIC Bias Voltage		0 to 5.5	V	
Operating Junction Temperature		-40 to +125	°C	

**Note**

- The control logic pins should not float and should be set to either high or low logic levels.

Stresses beyond those listed under "Absolute Maximum Ratings" may cause permanent damage to the device. These are stress ratings only, and functional operation of the device at these or any other conditions beyond those indicated in the operational sections of the specifications is not implied. Exposure to absolute maximum rating conditions for extended periods may affect device reliability.



ELECTRICAL CHARACTERISTICS						
PARAMETER	SYMBOL	TEST CONDITION	LIMITS			UNIT
		UNLESS OTHERWISE SPECIFIED, V <sub>DD</sub> = 1.8 V, V <sub>DD2</sub> = 2.1 V, T <sub>A</sub> = -40 °C to 85 °C, TYPICAL VALUES are at 25 °C	MIN.	TYP.	MAX.	
Quiescent Current	I <sub>Q</sub>	L_Detect, GND_Detect are open	-	6	10	μA
Ear Jack In Current	I <sub>DD</sub>	L_Detect, GND_Detect are connected with 10 kΩ to GND	-	3	6	
S/E Detection Current	I <sub>DD2</sub>	S/E_DET = 0 V, S/E_REF = 1.05 V	-	2	3.5	
L_Detect Reference Voltage	V <sub>TH_L</sub>	L_DET switching low to high	1.33	1.4	1.5	V
Propagation Delay to DET	t <sub>PLH</sub>	C <sub>OUT</sub> = 15 pF, GND_DET = 0 V, L_DET = 1.52 V to DET = 0.9 V	80	149	300	ns
Propagation Delay to DET	t <sub>PHL</sub>	C <sub>OUT</sub> = 15 pF, GND_DET = 0 V, L_DET = 1.31 V to DET = 0.9 V	130	325	550	
Low Voltage L_DET Leakage	I <sub>L_DET</sub>	L_DET = 0 V	-	0.84	2	μA
High Voltage L_DET Leakage	I <sub>H_DET</sub>	L_DET = 1.8 V	-	30	-	pA
L_DET Input Capacitance	C <sub>L_DET</sub>		-	4	-	pF
GND_Detect Logic Low Voltage	V <sub>IL_GND</sub>		0.63	0.86	-	V
GND_Detect Logic High Voltage	V <sub>IH_GND</sub>		-	0.89	1.17	
GND_DET Propagation Delay to DET	t <sub>PGND_DET</sub>	C <sub>OUT</sub> = 15 pF, R <sub>L</sub> = 1 MΩ, L_DET = 0 V, GND_DET switches between 0 V and 1.8 V	-	10	-	ns
Low Voltage GND_DET Leakage	I <sub>IL</sub>	GND_DET = 0 V	-	0.93	2	μA
High Voltage GND_DET Leakage	I <sub>IH</sub>	GND_DET = 1.8 V	-	80	-	pA
GND_DET Input Capacitance	C <sub>G_DET</sub>	f = 1 MHz	-	3.5	-	pF
MIC Pull Down Resistance	R <sub>MIC</sub>	I <sub>MIC</sub> = 1 mA L_Detect, GND_Detect = open	-	-	1.25	Ω
MIC Leakage		V <sub>MIC</sub> = 2.4 V	-1	-	1	μA
DET Pull Up Resistance	R <sub>OUTH</sub>	L_Detect, GND_Detect = open	-	135	200	Ω
DET Pull Down Resistance	R <sub>OUTL</sub>	L_Detect, GND_Detect are connected with 10 kΩ to GND	-	120	200	
DET High Logic Voltage	V <sub>OUTH</sub>	I <sub>DET</sub> = 0.1 mA, L_Detect, GND_Detect = open	1.6	-	-	V
DET Low Logic Voltage	V <sub>OUTL</sub>	I <sub>DET</sub> = 0.1 mA, L_Detect, GND_Detect are connected with 10 kΩ to GND	-	-	0.3	
DET Rise Time	t <sub>DET_R</sub>	C <sub>OUT</sub> = 15 pF, R <sub>L</sub> = 1 MΩ, DET = 10 % to 90 %	-	14	-	ns
DET Fall Time	t <sub>DET_F</sub>	C <sub>OUT</sub> = 15 pF, R <sub>L</sub> = 1 MΩ, DET = 90 % to 10 %	-	4.4	-	
Propagation Delay to S/E	t <sub>PS/E</sub>	C <sub>OUT</sub> = 15 pF, R <sub>L</sub> = 1 MΩ, V <sub>CM</sub> = mid-supply, 100 mV overdrive	50	170	500	
Input Leakage	I <sub>SE_IN</sub>	V <sub>CM</sub> = 0.9 V	-	4	-	pA
Input Capacitance	C <sub>SE_IN</sub>	f = 1 MHz	-	3.5	-	pF
Voltage Output Low	V <sub>OL</sub>	I <sub>OL</sub> = 0.1 mA	-	-	0.2	V
Voltage Output High	V <sub>OH</sub>	I <sub>OH</sub> = 0.1 mA	1.9	-	-	
Rise Time	t <sub>S/E_R</sub>	C <sub>OUT</sub> = 15 pF, R <sub>L</sub> = 1 MΩ, S/E = 10 % to 90 %	-	16	-	ns
Fall Time	t <sub>S/E_F</sub>	C <sub>OUT</sub> = 15 pF, R <sub>L</sub> = 1 MΩ, S/E = 90 % to 10 %	-	12.1	-	

**TYPICAL CHARACTERISTICS** ( $T_A = 25\text{ }^\circ\text{C}$ , unless otherwise noted)

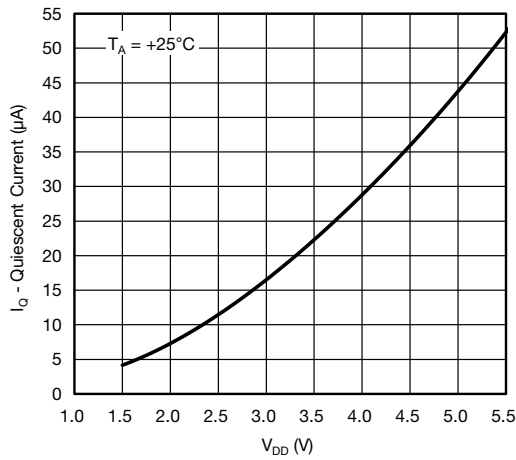

**Quiescent Current vs. V<sub>DD</sub>**

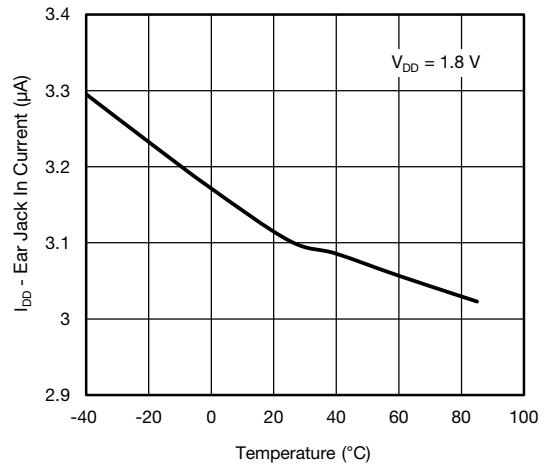

**Ear Jack In Current vs. Temperature**

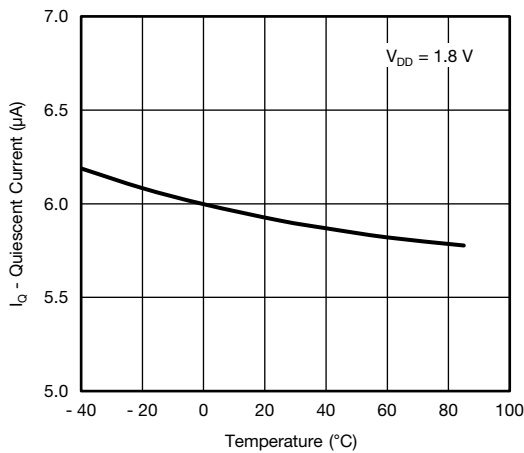

**Quiescent Current vs. Temperature**

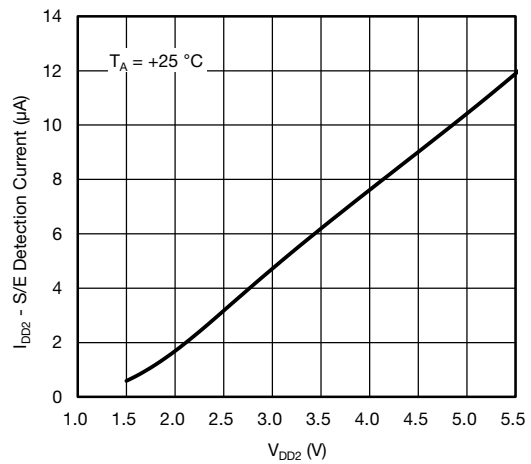

**S/E Detection Current vs. V<sub>DD2</sub>**

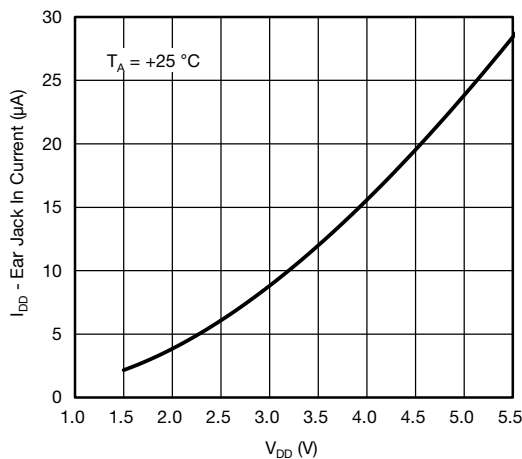

**Ear Jack In Current vs. V<sub>DD</sub>**

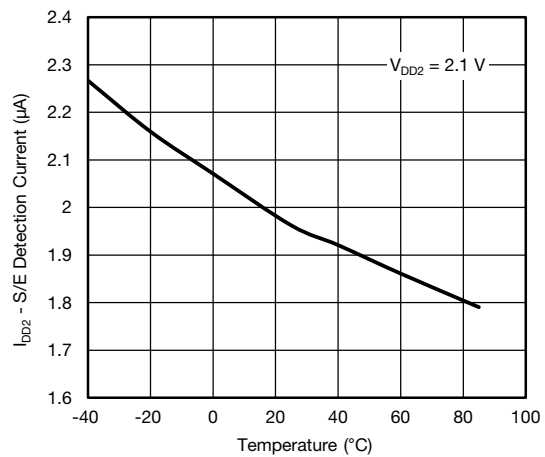

**S/E Detection Current vs. Temperature**

**TYPICAL CHARACTERISTICS** ( $T_A = 25\text{ }^\circ\text{C}$ , unless otherwise noted)

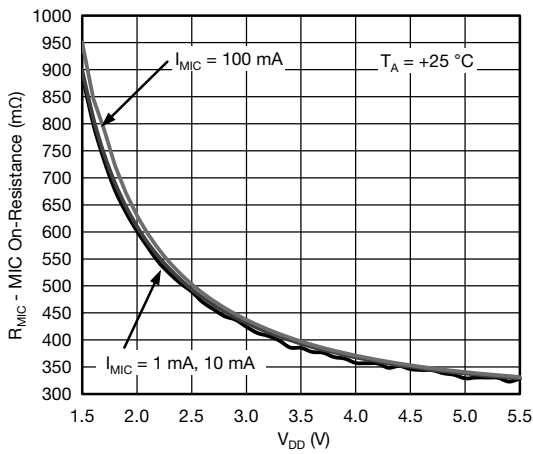

**MIC On Resistance vs. V<sub>DD</sub>**

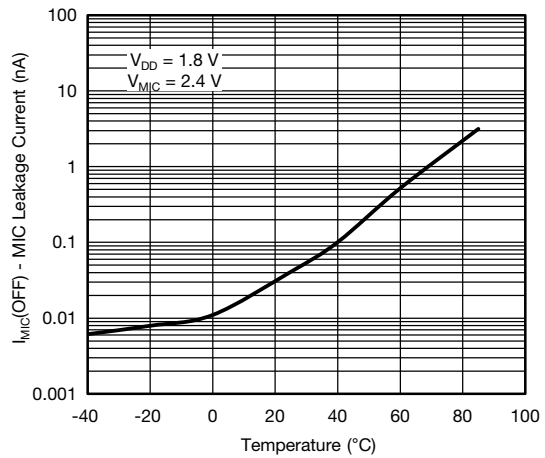

**MIC Leakage Current vs. Temperature**

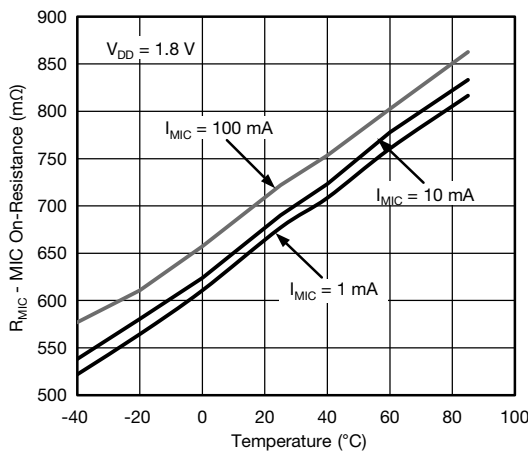

**MIC On Resistance vs. Temperature**

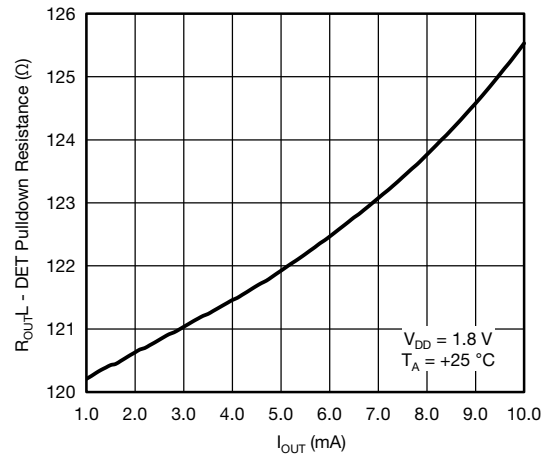

**DET Pulldown Resistance vs. I<sub>OUT</sub>**

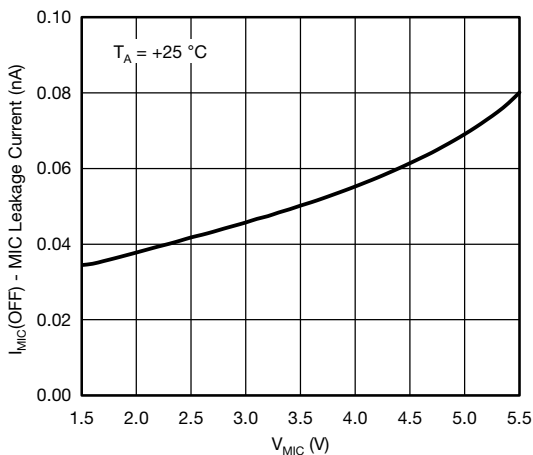

**MIC Leakage Current vs. V<sub>MIC</sub>**

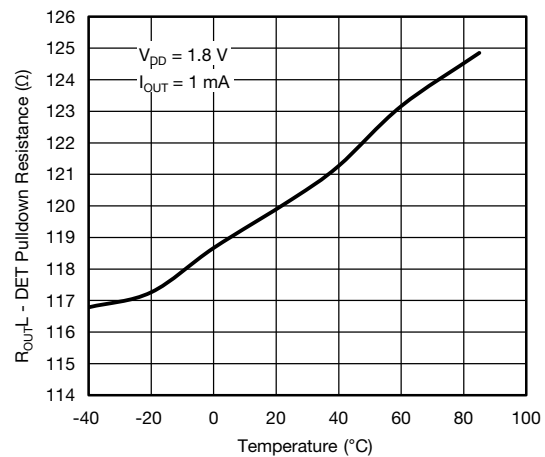

**DET Pulldown Resistance vs. Temperature**



**TYPICAL CHARACTERISTICS** ( $T_A = 25\text{ }^\circ\text{C}$ , unless otherwise noted)

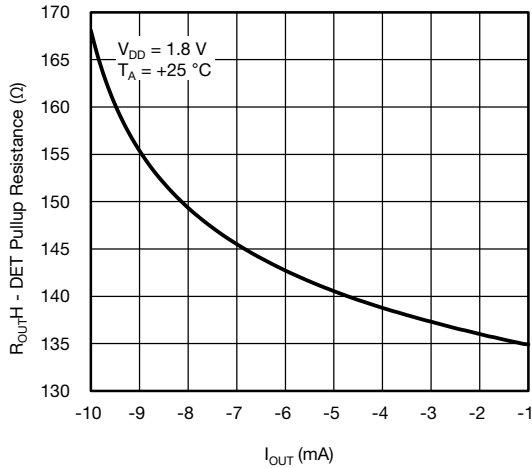

**DET Pullup Resistance vs.  $I_{OUT}$**

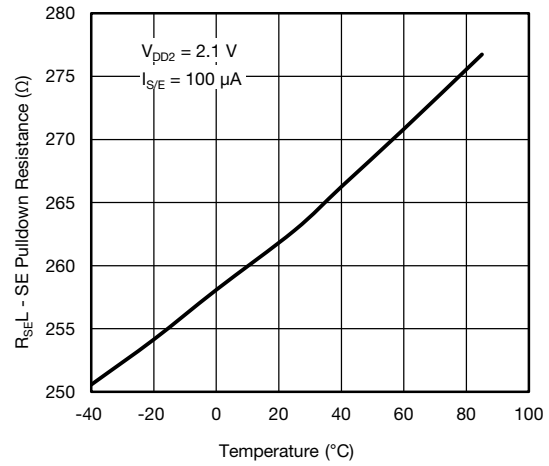

**SE Pulldown Resistance vs. Temperature**

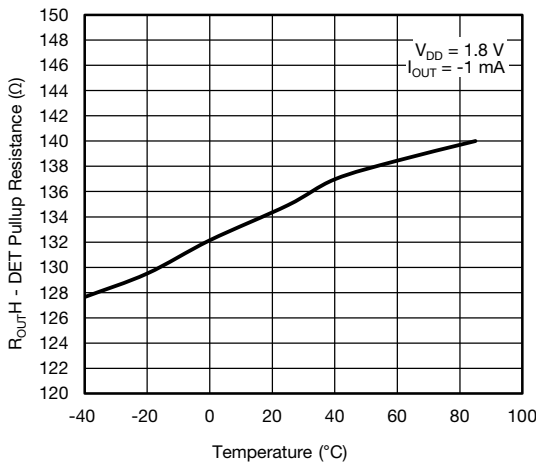

**DET Pullup Resistance vs. Temperature**

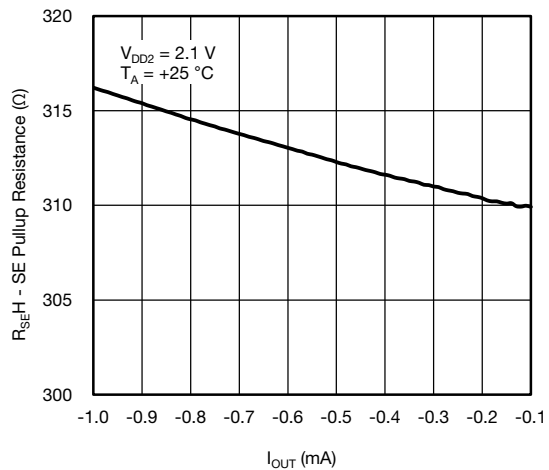

**SE Pullup Resistance vs.  $I_{OUT}$**

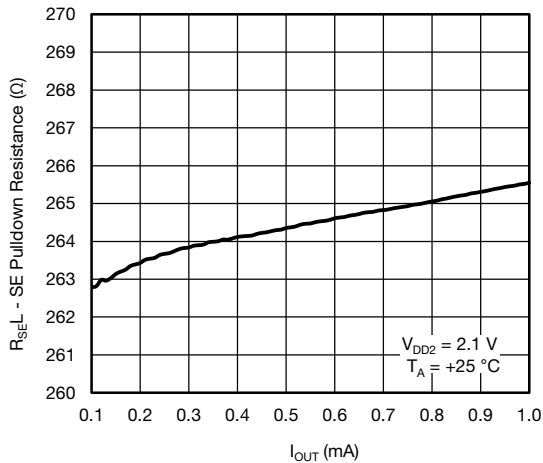

**SE Pulldown Resistance vs.  $I_{OUT}$**

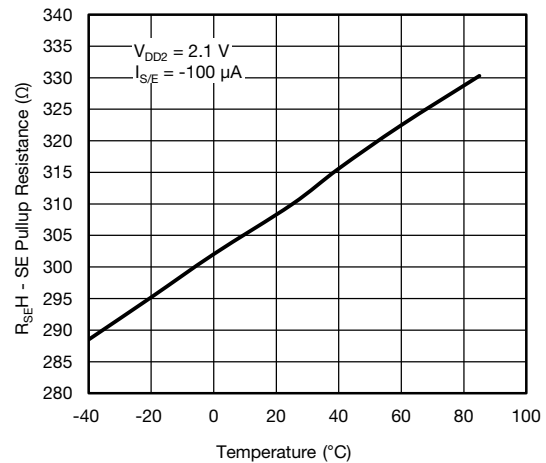

**SE Pullup Resistance vs. Temperature**



TYPICAL CHARACTERISTICS (T<sub>A</sub> = 25 °C, unless otherwise noted)

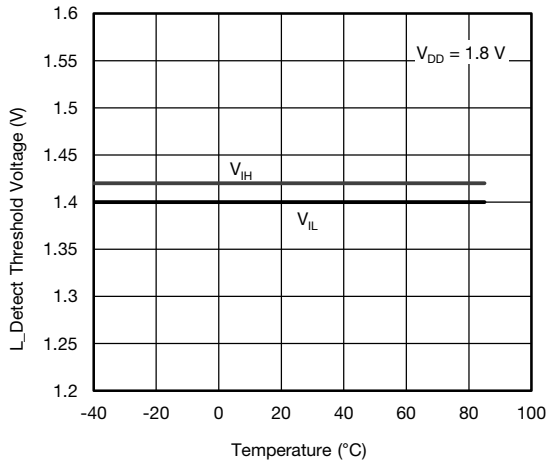

L\_Detect Threshold Voltage vs. Temperature

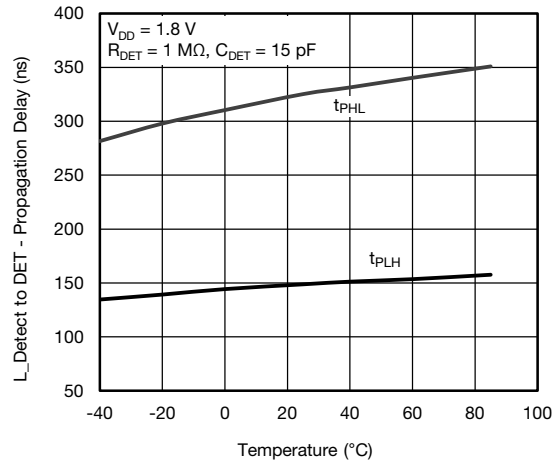

L\_Detect to DET Propagation Delay vs. Temperature

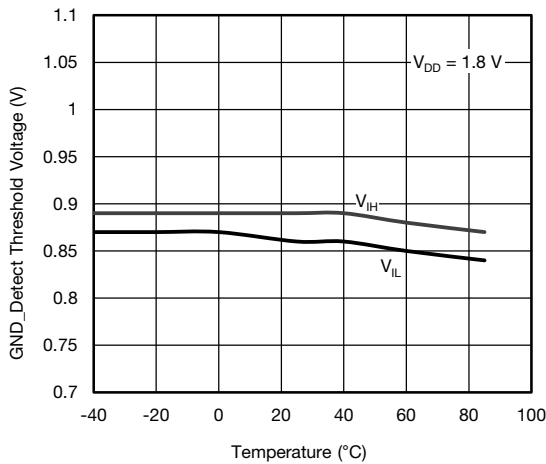

GND\_Detect Threshold Voltage vs. Temperature

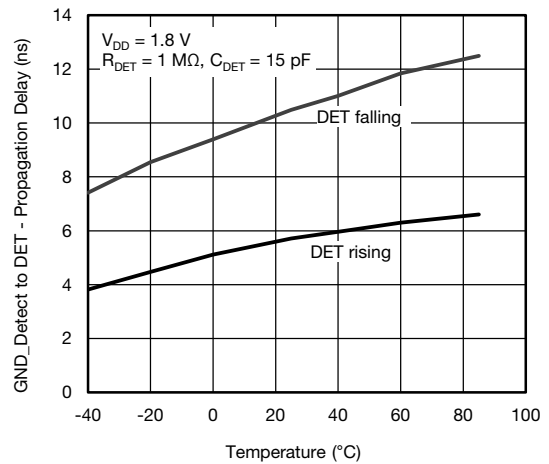

GND\_Detect to DET Propagation Delay vs. Temperature

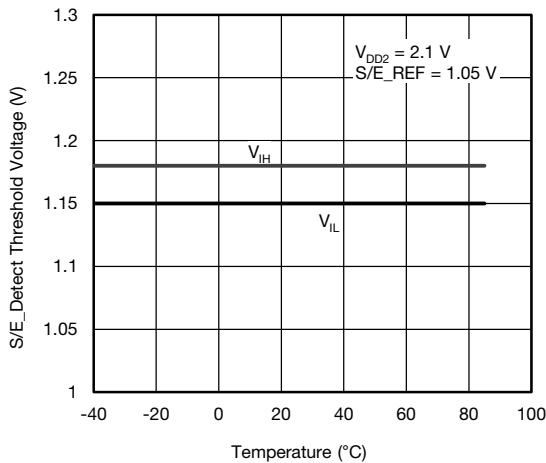

S/E\_Detect Threshold Voltage vs. Temperature

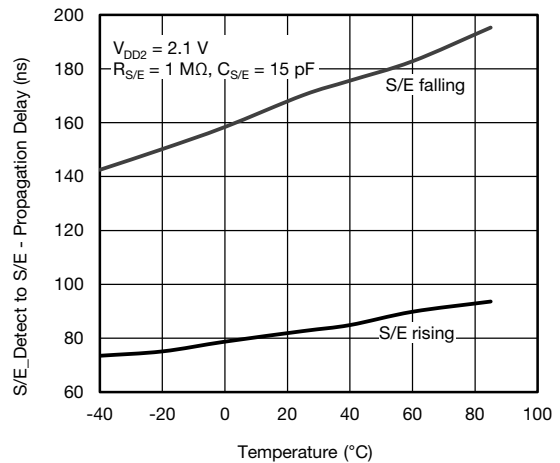

S/E\_Detect to S/E Propagation Delay vs. Temperature





**TYPICAL CHARACTERISTICS** ( $T_A = 25\text{ }^\circ\text{C}$ , unless otherwise noted)

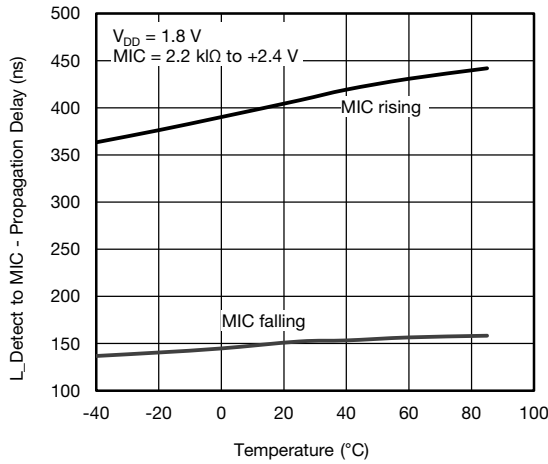

**L\_Detect to MIC Propagation Delay vs. Temperature**

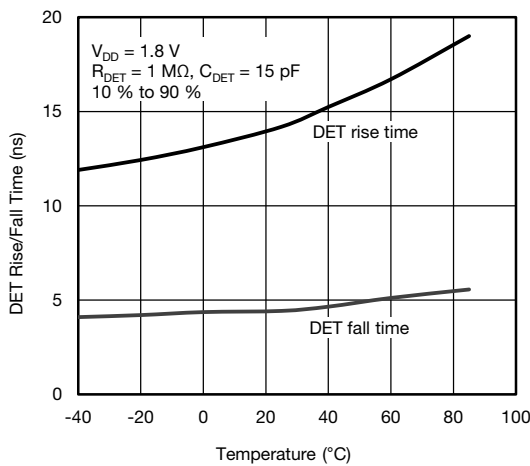

**DET Rise / Fall Time vs. Temperature**

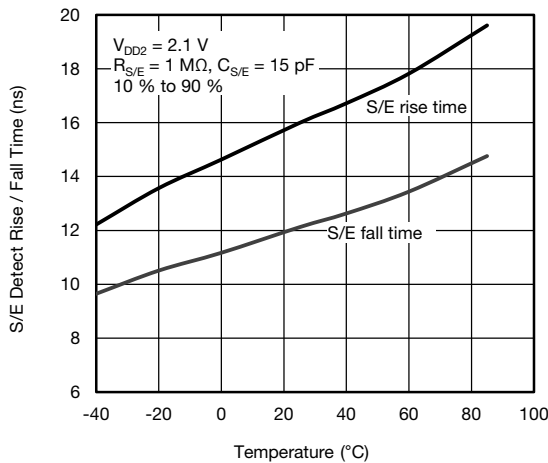

**S/E\_Detect to Rise / Fall Time vs. Temperature**

**TEST CIRCUIT**

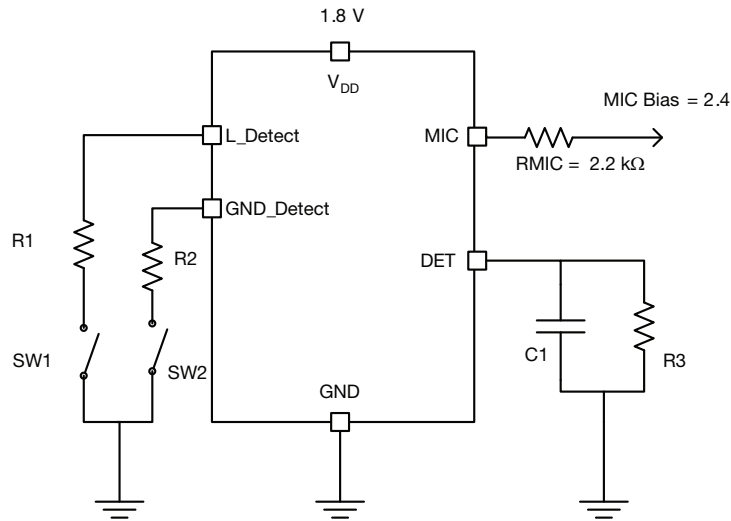

Fig. 4 - Test Circuit

**TIMING DIAGRAM**

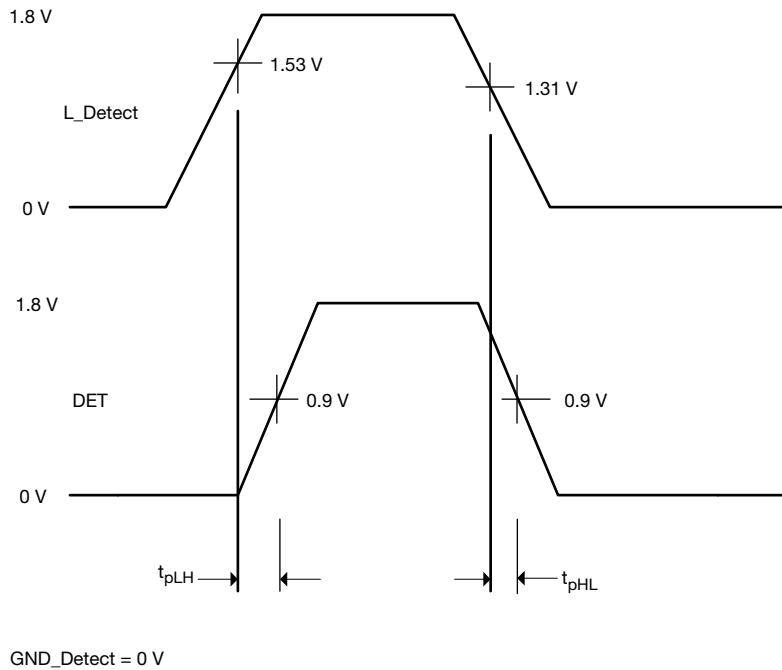
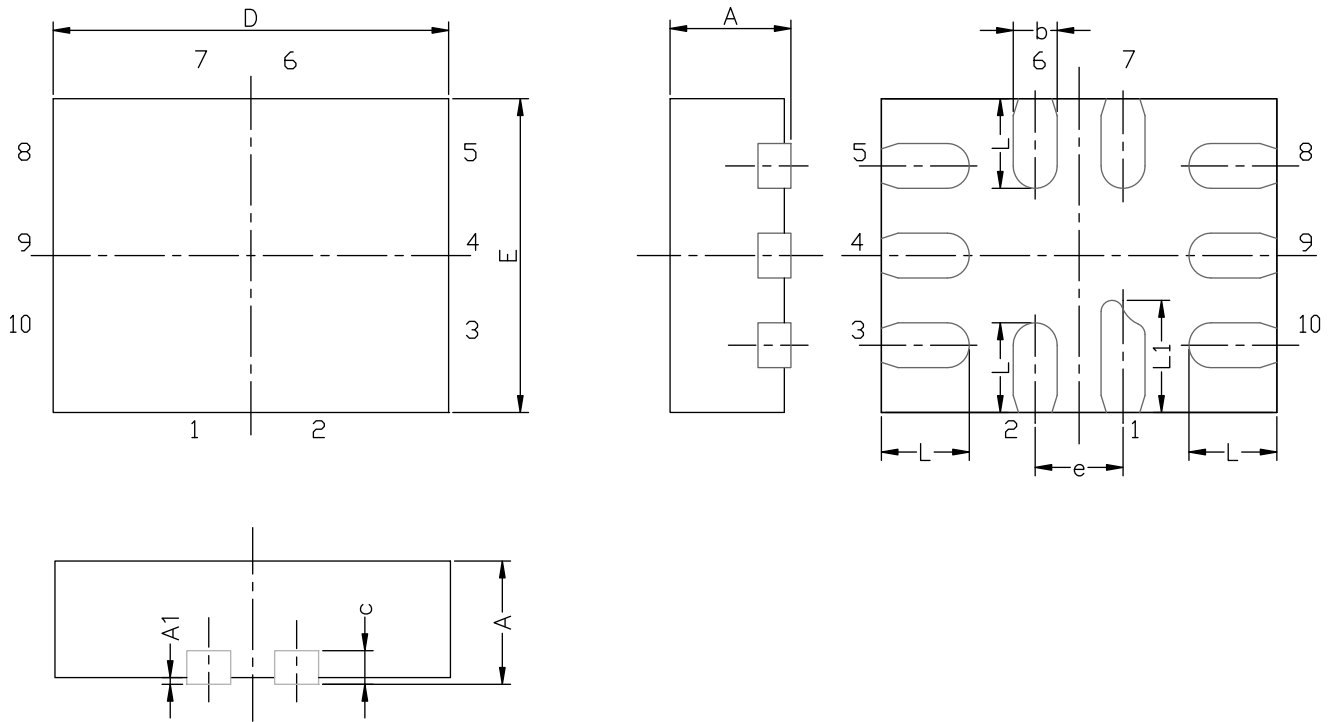

Fig. 5 - Timing Diagram

Vishay Siliconix maintains worldwide manufacturing capability. Products may be manufactured at one of several qualified locations. Reliability data for Silicon Technology and Package Reliability represent a composite of all qualified locations. For related documents such as package/tape drawings, part marking, and reliability data, see [www.vishay.com/ppg?62970](http://www.vishay.com/ppg?62970).

## MINI QFN-10L CASE OUTLINE



DIM	MILLIMETERS			INCHES		
	MIN.	NAM.	MAX.	MIN.	NAM.	MAX.
A	0.45	0.55	0.60	0.0177	0.0217	0.0236
A1	0.00	-	0.05	0.000	-	0.002
b	0.15	0.20	0.25	0.006	0.008	0.010
c	0.150 or 0.127 REF <sup>(1)</sup>			0.006 or 0.005 REF <sup>(1)</sup>		
D	1.70	1.80	1.90	0.067	0.071	0.075
E	1.30	1.40	1.50	0.051	0.055	0.059
e	0.40 BSC			0.016 BSC		
L	0.35	0.40	0.45	0.014	0.016	0.018
L1	0.45	0.50	0.55	0.0177	0.0197	0.0217

**Note**

<sup>(1)</sup> The dimension depends on the leadframe that assembly house used.

ECN T16-0163-Rev. B, 16-May-16  
DWG: 5957

**RECOMMENDED MINIMUM PADS FOR MINI QFN 10L**

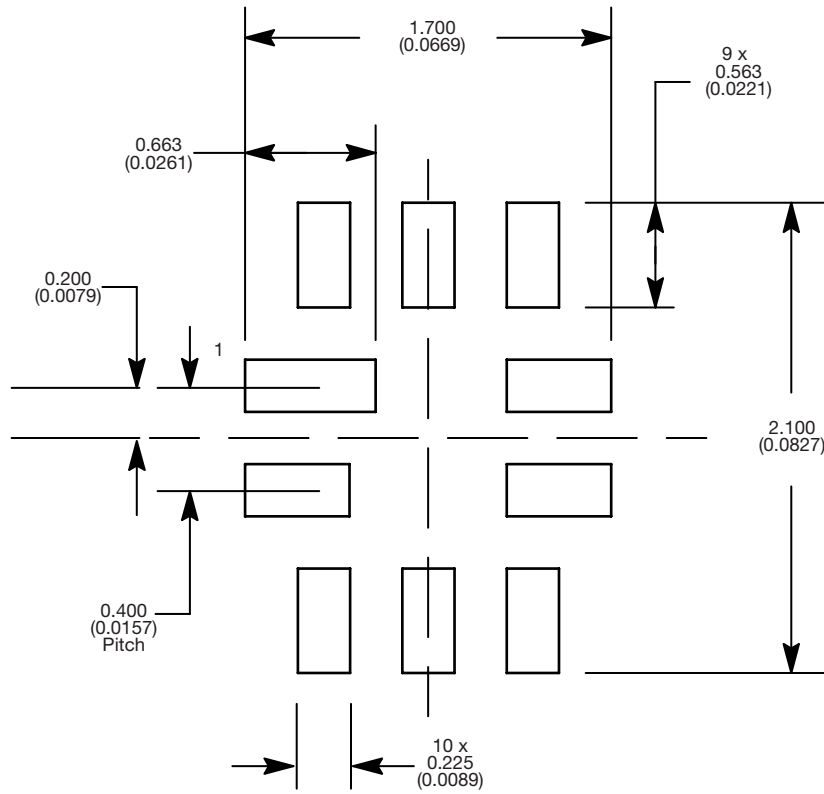

Mounting Footprint  
Dimensions in mm (inch)



## Disclaimer

ALL PRODUCT, PRODUCT SPECIFICATIONS AND DATA ARE SUBJECT TO CHANGE WITHOUT NOTICE TO IMPROVE RELIABILITY, FUNCTION OR DESIGN OR OTHERWISE.

Vishay Intertechnology, Inc., its affiliates, agents, and employees, and all persons acting on its or their behalf (collectively, "Vishay"), disclaim any and all liability for any errors, inaccuracies or incompleteness contained in any datasheet or in any other disclosure relating to any product.

Vishay makes no warranty, representation or guarantee regarding the suitability of the products for any particular purpose or the continuing production of any product. To the maximum extent permitted by applicable law, Vishay disclaims (i) any and all liability arising out of the application or use of any product, (ii) any and all liability, including without limitation special, consequential or incidental damages, and (iii) any and all implied warranties, including warranties of fitness for particular purpose, non-infringement and merchantability.

Statements regarding the suitability of products for certain types of applications are based on Vishay's knowledge of typical requirements that are often placed on Vishay products in generic applications. Such statements are not binding statements about the suitability of products for a particular application. It is the customer's responsibility to validate that a particular product with the properties described in the product specification is suitable for use in a particular application. Parameters provided in datasheets and/or specifications may vary in different applications and performance may vary over time. All operating parameters, including typical parameters, must be validated for each customer application by the customer's technical experts. Product specifications do not expand or otherwise modify Vishay's terms and conditions of purchase, including but not limited to the warranty expressed therein.

Except as expressly indicated in writing, Vishay products are not designed for use in medical, life-saving, or life-sustaining applications or for any other application in which the failure of the Vishay product could result in personal injury or death. Customers using or selling Vishay products not expressly indicated for use in such applications do so at their own risk. Please contact authorized Vishay personnel to obtain written terms and conditions regarding products designed for such applications.

No license, express or implied, by estoppel or otherwise, to any intellectual property rights is granted by this document or by any conduct of Vishay. Product names and markings noted herein may be trademarks of their respective owners.

## Material Category Policy

**Vishay Intertechnology, Inc. hereby certifies that all its products that are identified as RoHS-Compliant fulfill the definitions and restrictions defined under Directive 2011/65/EU of The European Parliament and of the Council of June 8, 2011 on the restriction of the use of certain hazardous substances in electrical and electronic equipment (EEE) - recast, unless otherwise specified as non-compliant.**

**Please note that some Vishay documentation may still make reference to RoHS Directive 2002/95/EC. We confirm that all the products identified as being compliant to Directive 2002/95/EC conform to Directive 2011/65/EU.**

**Vishay Intertechnology, Inc. hereby certifies that all its products that are identified as Halogen-Free follow Halogen-Free requirements as per JEDEC JS709A standards. Please note that some Vishay documentation may still make reference to the IEC 61249-2-21 definition. We confirm that all the products identified as being compliant to IEC 61249-2-21 conform to JEDEC JS709A standards.**



Компания «ЭлектроПласт» предлагает заключение долгосрочных отношений при поставках импортных электронных компонентов на взаимовыгодных условиях!

Наши преимущества:

- Оперативные поставки широкого спектра электронных компонентов отечественного и импортного производства напрямую от производителей и с крупнейших мировых складов;
- Поставка более 17-ти миллионов наименований электронных компонентов;
- Поставка сложных, дефицитных, либо снятых с производства позиций;
- Оперативные сроки поставки под заказ (от 5 рабочих дней);
- Экспресс доставка в любую точку России;
- Техническая поддержка проекта, помощь в подборе аналогов, поставка прототипов;
- Система менеджмента качества сертифицирована по Международному стандарту ISO 9001;
- Лицензия ФСБ на осуществление работ с использованием сведений, составляющих государственную тайну;
- Поставка специализированных компонентов (Xilinx, Altera, Analog Devices, Intersil, Interpoint, Microsemi, Aeroflex, Peregrine, Syfer, Eurofarad, Texas Instrument, Miteq, Cobham, E2V, MA-COM, Hittite, Mini-Circuits, General Dynamics и др.);

Помимо этого, одним из направлений компании «ЭлектроПласт» является направление «Источники питания». Мы предлагаем Вам помощь Конструкторского отдела:

- Подбор оптимального решения, техническое обоснование при выборе компонента;
- Подбор аналогов;
- Консультации по применению компонента;
- Поставка образцов и прототипов;
- Техническая поддержка проекта;
- Защита от снятия компонента с производства.



#### Как с нами связаться

**Телефон:** 8 (812) 309 58 32 (многоканальный)

**Факс:** 8 (812) 320-02-42

**Электронная почта:** [org@eplast1.ru](mailto:org@eplast1.ru)

**Адрес:** 198099, г. Санкт-Петербург, ул. Калинина, дом 2, корпус 4, литера А.