

LENINA-M

~30° medium beam

TECHNICAL SPECIFICATIONS:

Dimensions	Ø 74.0 mm
Height	40 mm
Fastening	socket
ROHS compliant	yes ⓘ

MATERIAL SPECIFICATIONS:

Component	Type	Material	Colour	Finish	Coating
LENINA-M	Reflector	PC	metal		lacquer



ORDERING INFORMATION:



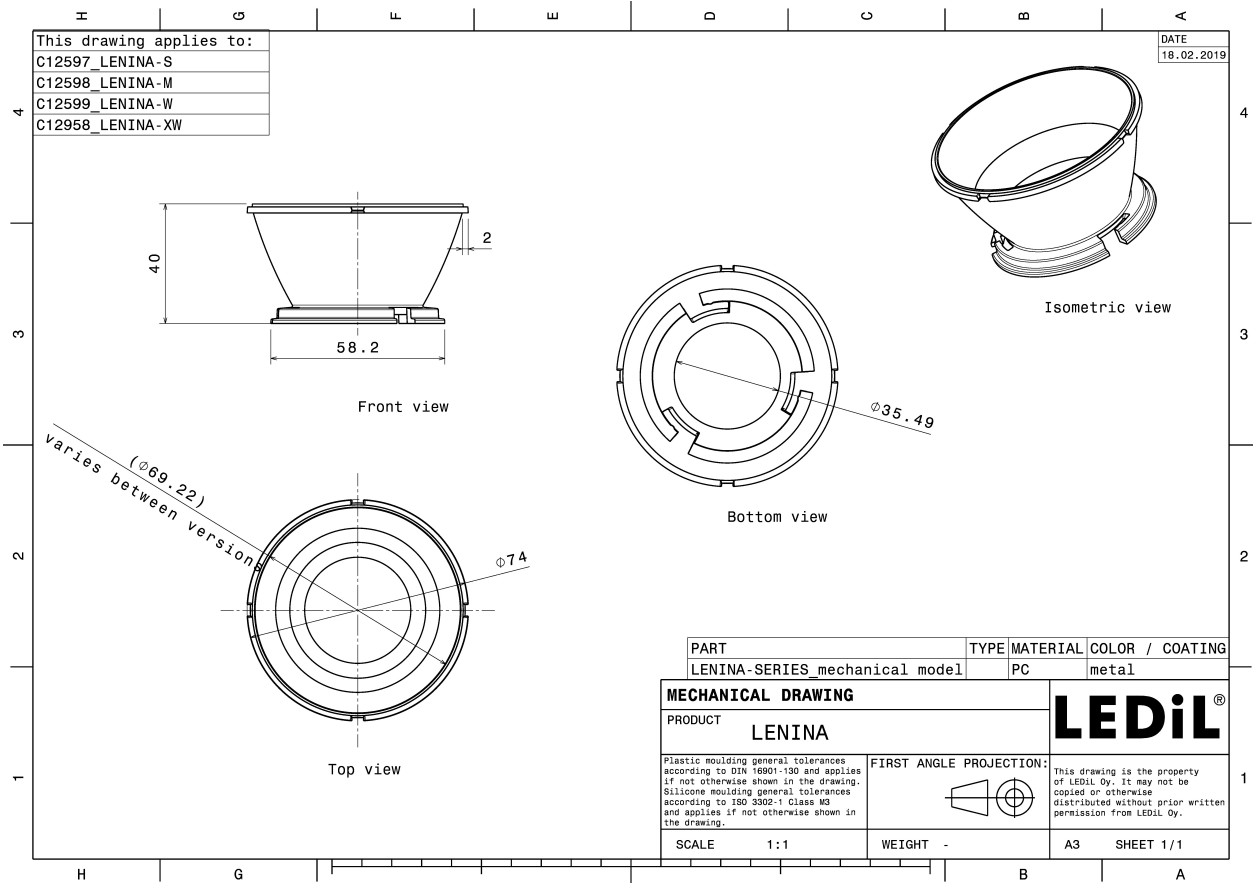

Component	Qty in box	MOQ	MPQ	Box weight (kg)
C12598_LENINA-M » Box size: 476 x 273 x 197 mm	60	120	60	2.0

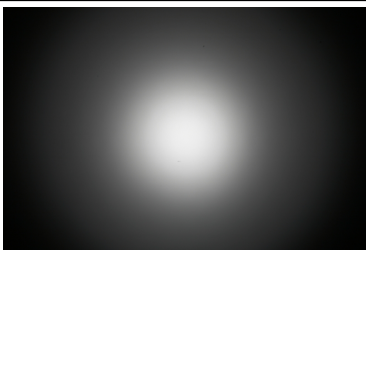
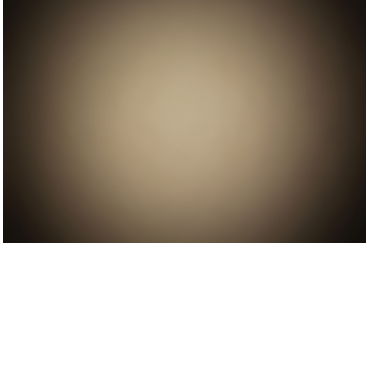
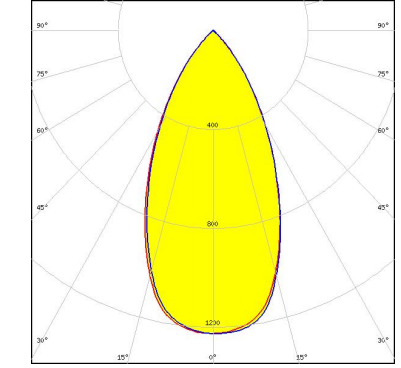

PHOTOMETRIC DATA (MEASURED):

<p>bridgelux.</p> <p>LED BXRA ES Rectangle FWHM 36.0° Efficiency 78 % LEDs/each optic 1 Light colour White Required components: C12153_LENINA-STD-BASE-BXRA C12606_LENINA-DL</p>	
<p>bridgelux.</p> <p>LED BXRA ES Rectangle FWHM 29.0° Efficiency 86 % LEDs/each optic 1 Light colour White Required components: C12153_LENINA-STD-BASE-BXRA</p>	
<p>bridgelux.</p> <p>LED BXRA RS FWHM 47.0° Efficiency 80 % Peak intensity 1.2 cd/lm LEDs/each optic 1 Light colour White Required components: C12229_LENINA-STD-BASE-RS C12606_LENINA-DL</p>	
<p>bridgelux.</p> <p>LED BXRA RS FWHM 44.0° Efficiency 88 % Peak intensity 1.4 cd/lm LEDs/each optic 1 Light colour White Required components: C12229_LENINA-STD-BASE-RS</p>	

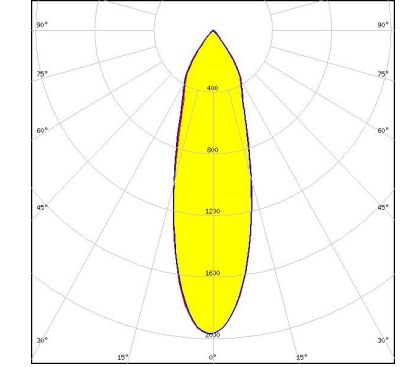
PHOTOMETRIC DATA (MEASURED):

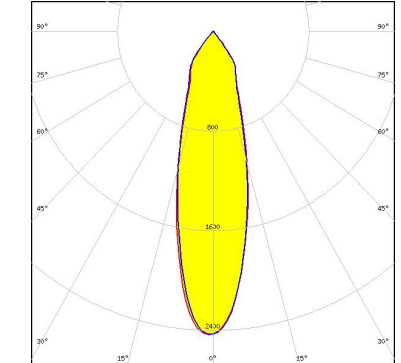
<p>bridgelux.</p> <p>LED V10 Gen6</p> <p>FWHM 21.0°</p> <p>Efficiency 84 %</p> <p>Peak intensity 3.2 cd/lm</p> <p>LEDs/each optic 1</p> <p>Light colour White</p> <p>Required components:</p> <p>C13186_LENINA-STD-BASE-CXA15</p> <p>C12606_LENINA-DL</p>		
<p>bridgelux.</p> <p>LED Vero SE 29</p> <p>FWHM 51.0°</p> <p>Efficiency 92 %</p> <p>Peak intensity 1.2 cd/lm</p> <p>LEDs/each optic 1</p> <p>Light colour White</p> <p>Required components:</p> <p>C15083_LENINA-STD-BASE-VERO29</p>		
<p>bridgelux.</p> <p>LED VERO13</p> <p>FWHM 31.0°</p> <p>Efficiency 87 %</p> <p>Peak intensity 2 cd/lm</p> <p>LEDs/each optic 1</p> <p>Light colour White</p> <p>Required components:</p> <p>C13868_LENINA-STD-BASE-VERO13-18</p> <p>C12606_LENINA-DL</p>		
<p>bridgelux.</p> <p>LED VERO13</p> <p>FWHM 28.0°</p> <p>Efficiency 91 %</p> <p>Peak intensity 2.4 cd/lm</p> <p>LEDs/each optic 1</p> <p>Light colour White</p> <p>Required components:</p> <p>C13868_LENINA-STD-BASE-VERO13-18</p>		

PHOTOMETRIC DATA (MEASURED):

<p>bridgelux.</p> <p>LED VERO18</p> <p>FWHM 35.0°</p> <p>Efficiency 90 %</p> <p>Peak intensity 1.9 cd/lm</p> <p>LEDs/each optic 1</p> <p>Light colour White</p> <p>Required components: C13868_LENINA-STD-BASE-VERO13-18</p>	
<p>bridgelux.</p> <p>LED VERO18</p> <p>FWHM 37.0°</p> <p>Efficiency 86 %</p> <p>Peak intensity 1.6 cd/lm</p> <p>LEDs/each optic 1</p> <p>Light colour White</p> <p>Required components: C13868_LENINA-STD-BASE-VERO13-18 C12606_LENINA-DL</p>	
<p>bridgelux.</p> <p>LED VERO29</p> <p>FWHM 52.0°</p> <p>Efficiency 85 %</p> <p>Peak intensity 1.1 cd/lm</p> <p>LEDs/each optic 1</p> <p>Light colour White</p> <p>Required components: C13867_LENINA-STD-BASE-VERO29 C12606_LENINA-DL</p>	
<p>bridgelux.</p> <p>LED VERO29</p> <p>FWHM 52.0°</p> <p>Efficiency 89 %</p> <p>Peak intensity 1.2 cd/lm</p> <p>LEDs/each optic 1</p> <p>Light colour White</p> <p>Required components: C13867_LENINA-STD-BASE-VERO29</p>	

PHOTOMETRIC DATA (MEASURED):

CITIZEN

LED CL-L340
FWHM 35.0°
Efficiency 78 %
LEDs/each optic 1
Light colour White
Required components:
C11995_LENINA-STD-BASE-CL340
C12606_LENINA-DL

CITIZEN

LED CL-L340
FWHM 30.0°
Efficiency 86 %
LEDs/each optic 1
Light colour White
Required components:
C11995_LENINA-STD-BASE-CL340

CITIZEN

LED CL-L340
FWHM 26.0°
Efficiency 92 %
Peak intensity 2.5 cd/lm
LEDs/each optic 1
Light colour White
Required components:
C11995_LENINA-STD-BASE-CL340

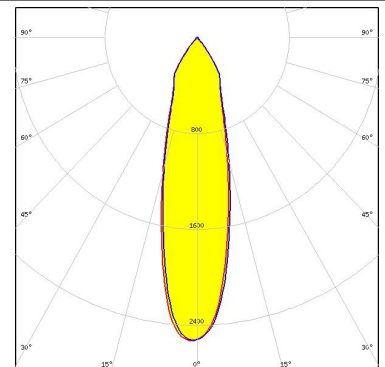
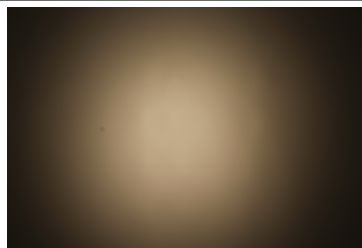

CITIZEN

LED CLL02x/CLU02x (LES10)
FWHM 23.0°
Efficiency 91 %
Peak intensity 3 cd/lm
LEDs/each optic 1
Light colour White
Required components:
C13868_LENINA-STD-BASE-VERO13-18
Bender Wirth: 434 Typ L1

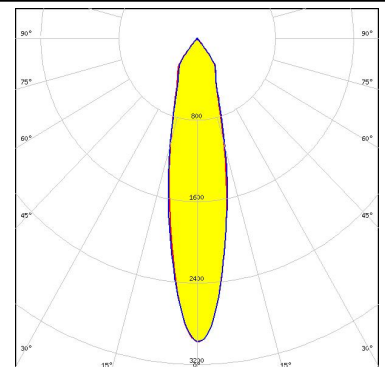
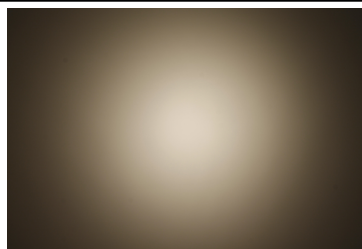

PHOTOMETRIC DATA (MEASURED):

CITIZEN

LED CLL02x/CLU02x (LES10)
 FWHM 26.0°
 Efficiency 87 %
 Peak intensity 2.3 cd/lm
 LEDs/each optic 1
 Light colour White
 Required components:
 C13868_LENINA-STD-BASE-VERO13-18
 C12606_LENINA-DL
 Bender Wirth: 434 Typ L1

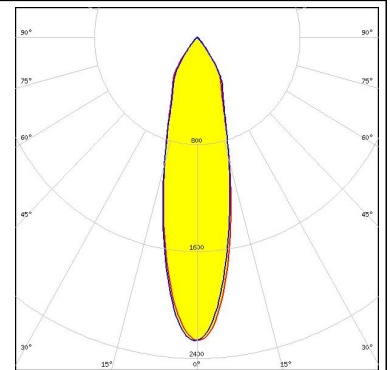
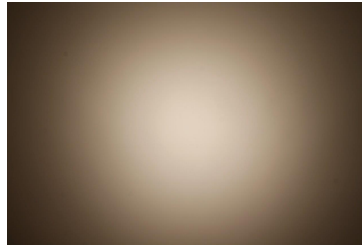

CITIZEN

LED CLL03x/CLU03x
 FWHM 28.0°
 Efficiency 91 %
 Peak intensity 2.4 cd/lm
 LEDs/each optic 1
 Light colour White
 Required components:
 C12691_LENINA-STD-BASE-CLL030

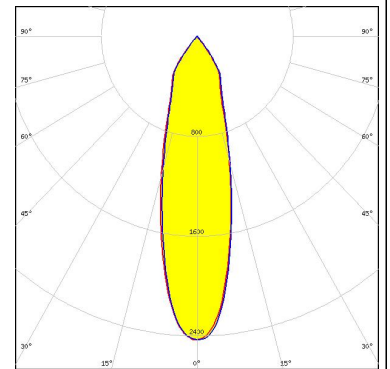
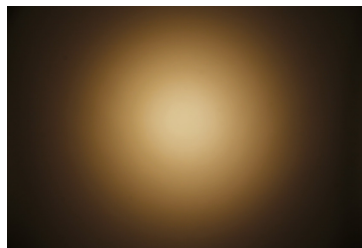

CITIZEN

LED CLL03x/CLU03x
 FWHM 30.0°
 Efficiency 87 %
 Peak intensity 2 cd/lm
 LEDs/each optic 1
 Light colour White
 Required components:
 C12691_LENINA-STD-BASE-CLL030
 C12606_LENINA-DL

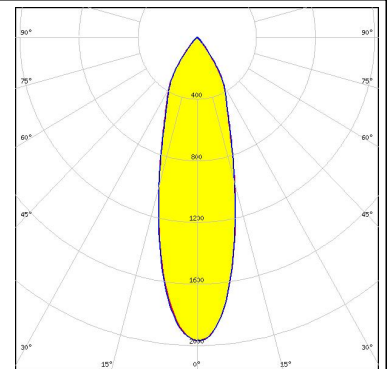
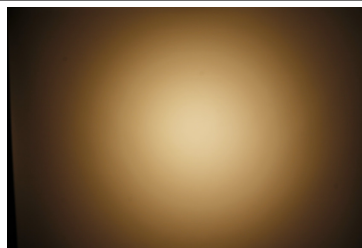

CITIZEN

LED CLL03x/CLU03x
 FWHM 29.0°
 Efficiency 91 %
 Peak intensity 2.3 cd/lm
 LEDs/each optic 1
 Light colour White
 Required components:
 C13868_LENINA-STD-BASE-VERO13-18
 Bender Wirth: 433 Typ L1

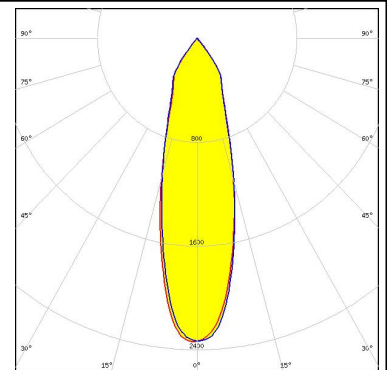
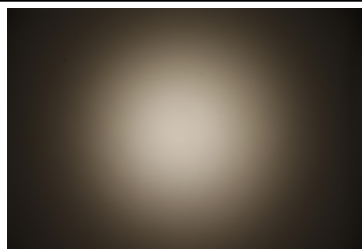

PHOTOMETRIC DATA (MEASURED):

CITIZEN

LED CLL03x/CLU03x
 FWHM 31.0°
 Efficiency 88 %
 Peak intensity 2 cd/lm
 LEDs/each optic 1
 Light colour White
 Required components:
 C13868_LENINA-STD-BASE-VERO13-18
 C12606_LENINA-DL
 Bender Wirth: 433 Typ L1

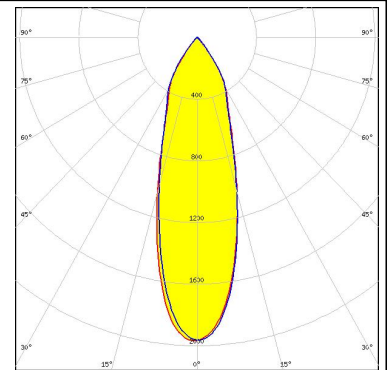
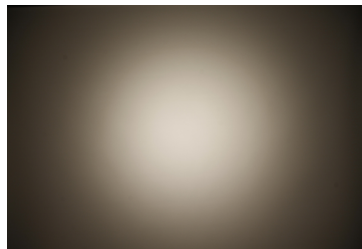

CITIZEN

LED CLL04x/CLU04x
 FWHM 43.0°
 Efficiency 78 %
 Peak intensity 1.2 cd/lm
 LEDs/each optic 1
 Light colour White
 Required components:
 C12692_LENINA-STD-BASE-CLL040
 C12606_LENINA-DL

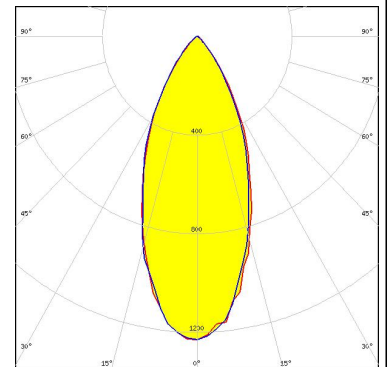
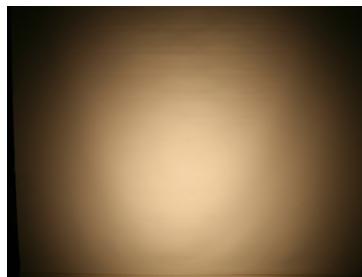

CITIZEN

LED CLL04x/CLU04x
 FWHM 38.0°
 Efficiency 76 %
 Peak intensity 1.4 cd/lm
 LEDs/each optic 1
 Light colour White
 Required components:
 C12606_LENINA-DL
 A.A.G. STUCCHI: 8102/G2 + S-8000/12

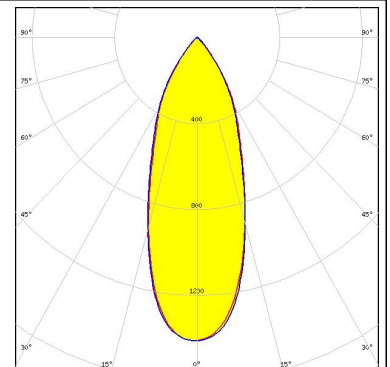
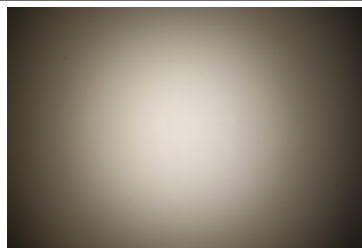

CITIZEN

LED CLL04x/CLU04x
 FWHM 37.0°
 Efficiency 87 %
 Peak intensity 1.6 cd/lm
 LEDs/each optic 1
 Light colour White
 Required components:
 C12606_LENINA-DL
 IDEAL: 50-2204CT + 50-2100LN

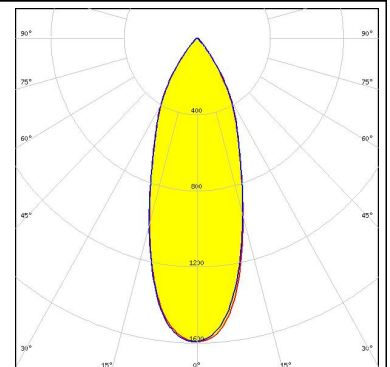

PHOTOMETRIC DATA (MEASURED):

CITIZEN

LED CLL04x/CLU04x
 FWHM 36.0°
 Efficiency 83 %
 Peak intensity 1.6 cd/lm
 LEDs/each optic 1
 Light colour White
 Required components:
 A.A.G. STUCCHI: 8102/G2 + S-8000/12

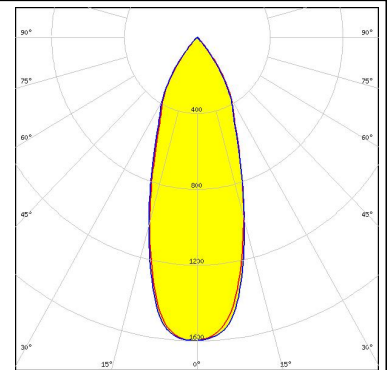
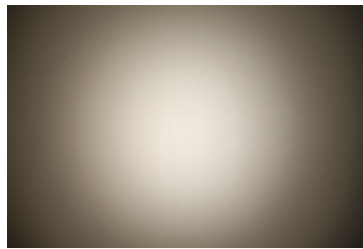

CITIZEN

LED CLL04x/CLU04x
 FWHM 39.0°
 Efficiency 92 %
 Peak intensity 1.7 cd/lm
 LEDs/each optic 1
 Light colour White
 Required components:
 C13867_LENINA-STD-BASE-VERO29
 Bender Wirth: 431 Typ L3

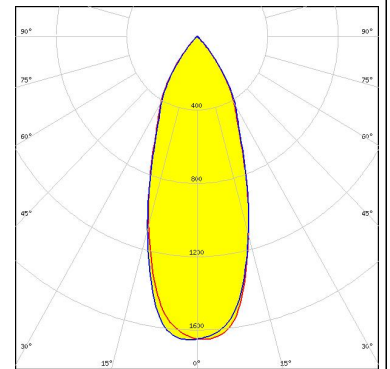
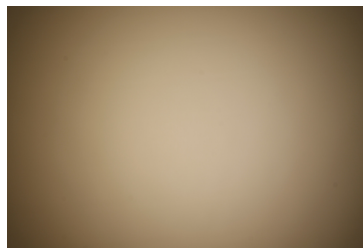

CITIZEN

LED CLL04x/CLU04x
 FWHM 35.0°
 Efficiency 90 %
 Peak intensity 1.8 cd/lm
 LEDs/each optic 1
 Light colour White
 Required components:
 IDEAL: 50-2204CT + 50-2100LN

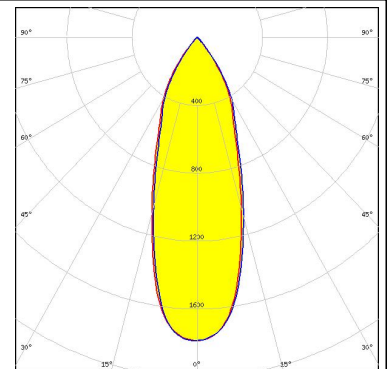
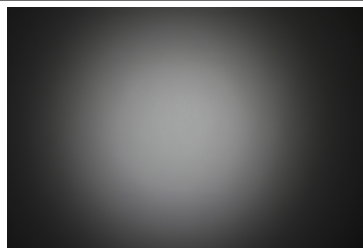

CITIZEN

LED CLL04x/CLU04x
 FWHM 40.0°
 Efficiency 86 %
 Peak intensity 1.5 cd/lm
 LEDs/each optic 1
 Light colour White
 Required components:
 C12692_LENINA-STD-BASE-CLL040

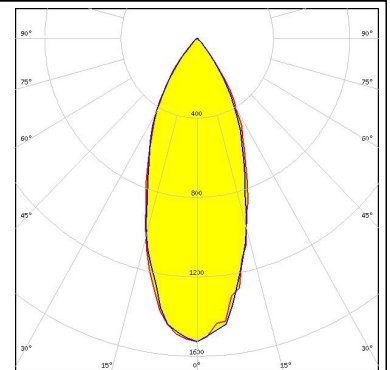
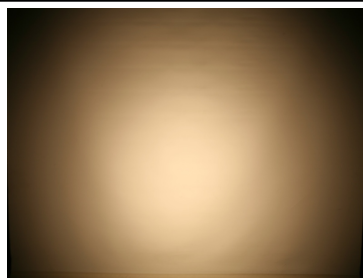

PHOTOMETRIC DATA (MEASURED):

CITIZEN

LED CLL04x/CLU04x
 FWHM 40.0°
 Efficiency 87 %
 Peak intensity 1.4 cd/lm
 LEDs/each optic 1
 Light colour White
 Required components:
 C13867_LENINA-STD-BASE-VERO29
 C12606_LENINA-DL
 Bender Wirth: 431 Typ L3

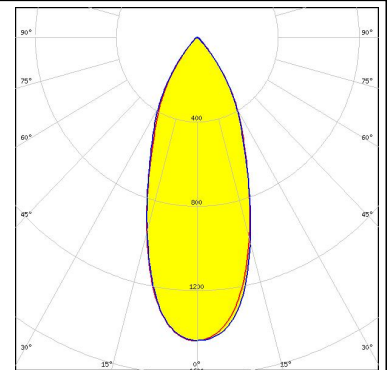

CITIZEN

LED CLU700/701/702
 FWHM 17.0°
 Efficiency 91 %
 Peak intensity 3.8 cd/lm
 LEDs/each optic 1
 Light colour White
 Required components:
 C13868_LENINA-STD-BASE-VERO13-18
 Bender Wirth: 434 Typ L1

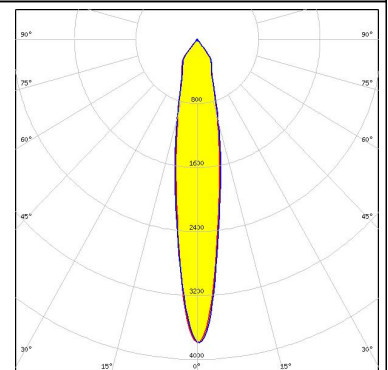

CITIZEN

LED CLU700/701/702
 FWHM 23.0°
 Efficiency 87 %
 Peak intensity 2.7 cd/lm
 LEDs/each optic 1
 Light colour White
 Required components:
 C13868_LENINA-STD-BASE-VERO13-18
 C12606_LENINA-DL
 Bender Wirth: 434 Typ L1

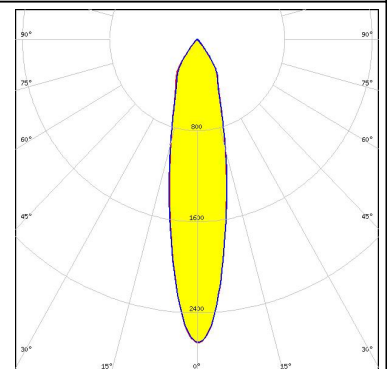

CITIZEN

LED CLU710/711
 FWHM 24.0°
 Efficiency 89 %
 Peak intensity 2.4 cd/lm
 LEDs/each optic 1
 Light colour White
 Required components:
 C12691_LENINA-STD-BASE-CLL030
 C12606_LENINA-DL

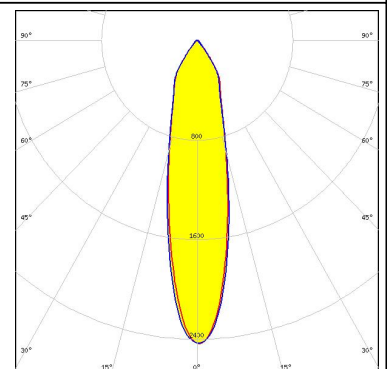
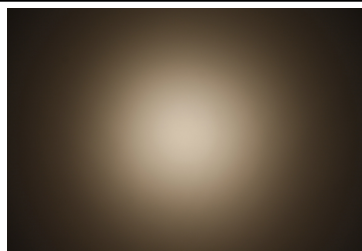

PHOTOMETRIC DATA (MEASURED):

CITIZEN

LED CLU710/711
 FWHM 19.0°
 Efficiency 93 %
 Peak intensity 3.3 cd/lm
 LEDs/each optic 1
 Light colour White
 Required components:
 C12691_LENINA-STD-BASE-CLL030

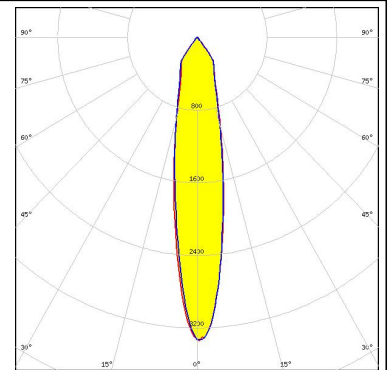

CITIZEN

LED CLU720/721
 FWHM 26.0°
 Efficiency 84 %
 Peak intensity 2.1 cd/lm
 LEDs/each optic 1
 Light colour White
 Required components:
 C12691_LENINA-STD-BASE-CLL030
 C12606_LENINA-DL

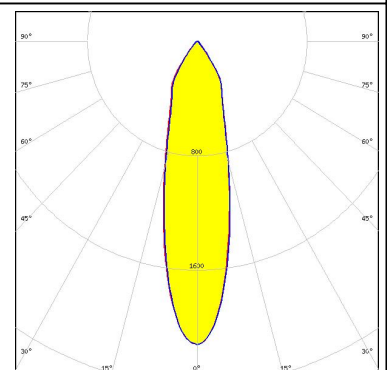
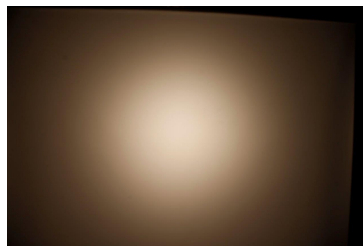

CITIZEN

LED CLU720/721
 FWHM 23.0°
 Efficiency 88 %
 Peak intensity 2.7 cd/lm
 LEDs/each optic 1
 Light colour White
 Required components:
 C12691_LENINA-STD-BASE-CLL030

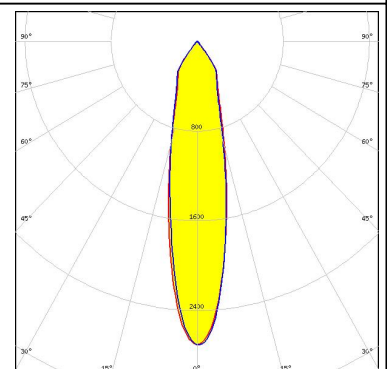
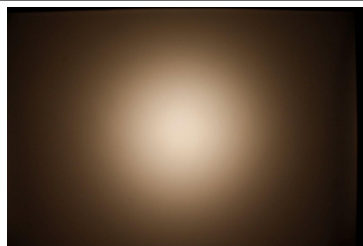

CITIZEN

LED CLU730/731
 FWHM 24.0°
 Efficiency 94 %
 Peak intensity 2.8 cd/lm
 LEDs/each optic 1
 Light colour White
 Required components:
 C12692_LENINA-STD-BASE-CLL040

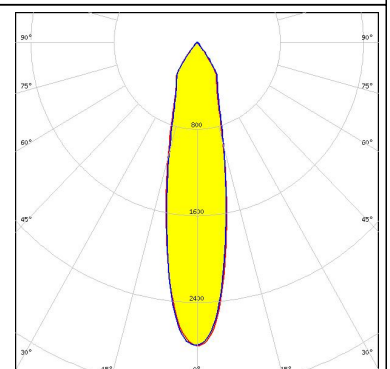
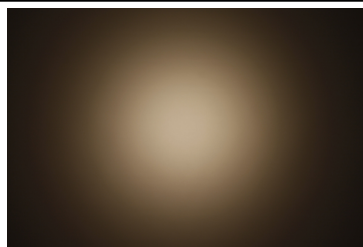

PHOTOMETRIC DATA (MEASURED):

CITIZEN

LED CLU730/731
 FWHM 26.0°
 Efficiency 84 %
 Peak intensity 2.1 cd/lm
 LEDs/each optic 1
 Light colour White
 Required components:
 C12692_LENINA-STD-BASE-CLL040
 C12606_LENINA-DL

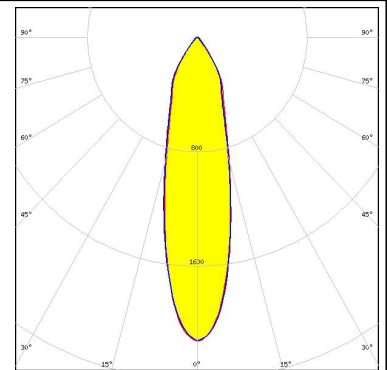
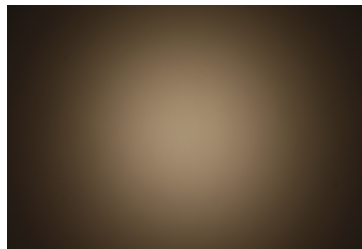

CREE

LED CMA1840
 FWHM 25.0°
 Efficiency 92 %
 Peak intensity 2.7 cd/lm
 LEDs/each optic 1
 Light colour White
 Required components:
 C14146_LENINA-STD-BASE-CXA18

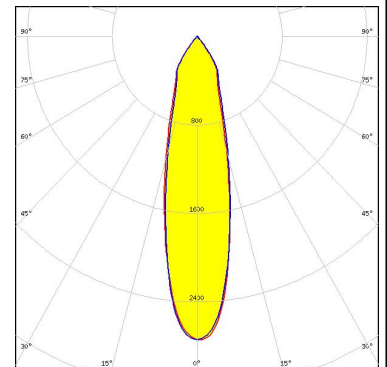
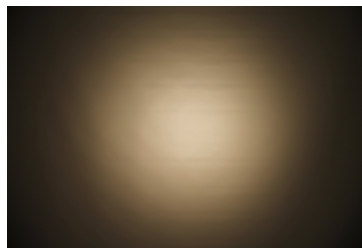

CREE

LED CMA1840
 FWHM 25.0°
 Efficiency 92 %
 Peak intensity 2.7 cd/lm
 LEDs/each optic 1
 Light colour White
 Required components:
 C14146_LENINA-STD-BASE-CXA18

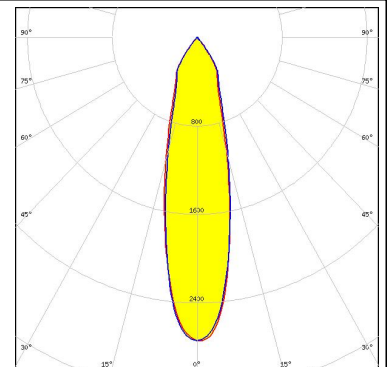
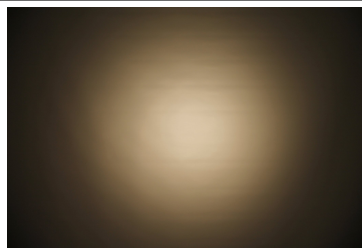

CREE

LED CMA2550
 FWHM 32.0°
 Efficiency 92 %
 Peak intensity 2.1 cd/lm
 LEDs/each optic 1
 Light colour White
 Required components:
 C13324_LENINA-STD-BASE-CXA25

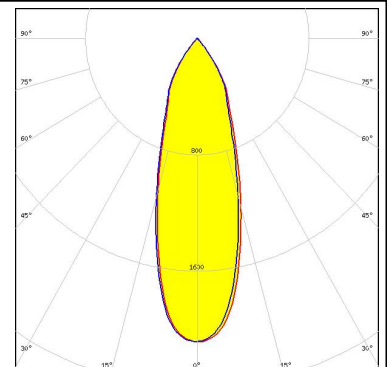
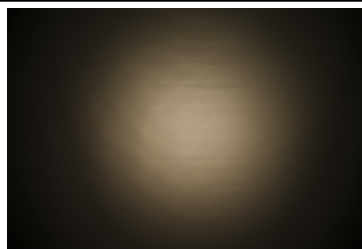

PHOTOMETRIC DATA (MEASURED):

CREE 

LED CMT14xx
 FWHM 25.0°
 Efficiency 92 %
 Peak intensity 2.8 cd/lm
 LEDs/each optic 1
 Light colour White
 Required components:
 C13868_LENINA-STD-BASE-VERO13-18
 Bender Wirth: 434 Typ L1

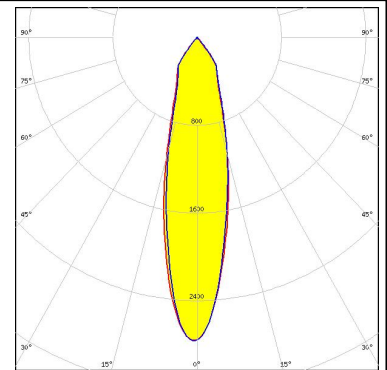

CREE 

LED CMT19xx
 FWHM 29.0°
 Efficiency 92 %
 Peak intensity 2.4 cd/lm
 LEDs/each optic 1
 Light colour White
 Required components:
 C12691_LENINA-STD-BASE-CLL030

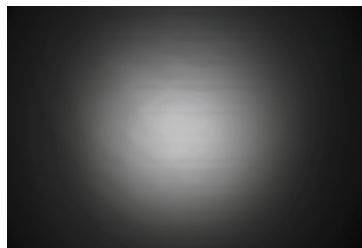

CREE 

LED CMT19xx
 FWHM 30.0°
 Efficiency 92 %
 Peak intensity 2.3 cd/lm
 LEDs/each optic 1
 Light colour White
 Required components:
 C13868_LENINA-STD-BASE-VERO13-18
 Bender Wirth: 477 Typ L1

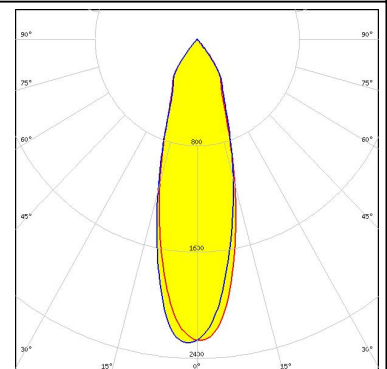
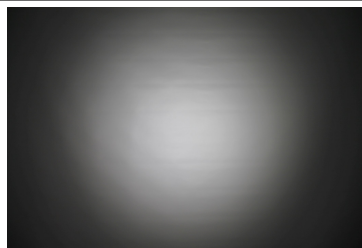

CREE 

LED CMT28xx
 FWHM 37.0°
 Efficiency 92 %
 Peak intensity 1.8 cd/lm
 LEDs/each optic 1
 Light colour White
 Required components:
 C12692_LENINA-STD-BASE-CLL040

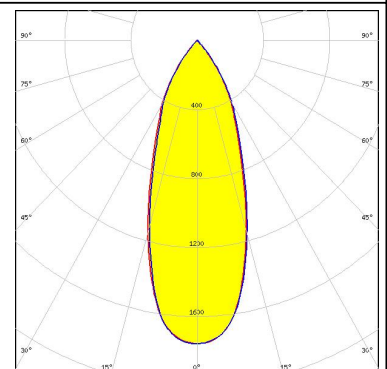
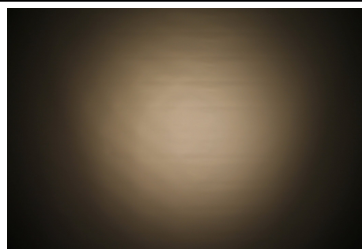

PHOTOMETRIC DATA (MEASURED):



LED CMT28xx
 FWHM 39.0°
 Efficiency 92 %
 Peak intensity 1.7 cd/lm
 LEDs/each optic 1
 Light colour White
 Required components:
 C13867_LENINA-STD-BASE-VERO29
 Bender Wirth: 471 Typ L3

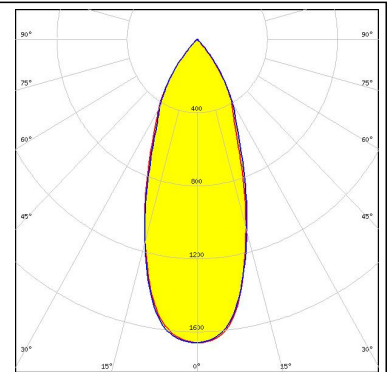
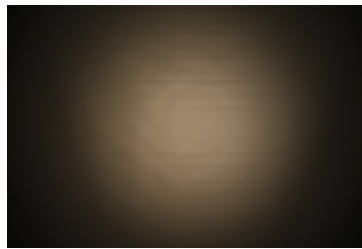

LED CXA/B 15xx
 FWHM 26.0°
 Efficiency 87 %
 Peak intensity 2.3 cd/lm
 LEDs/each optic 1
 Light colour White
 Required components:
 C13868_LENINA-STD-BASE-VERO13-18
 C12606_LENINA-DL
 Bender Wirth: 441 Typ L1

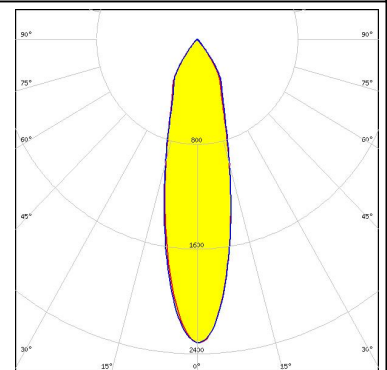
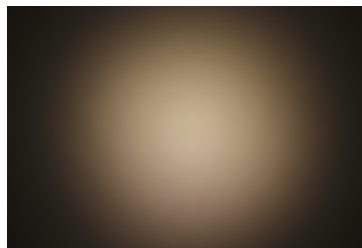

LED CXA/B 15xx
 FWHM 22.0°
 Efficiency 86 %
 Peak intensity 3.2 cd/lm
 LEDs/each optic 1
 Light colour White
 Required components:
 C13186_LENINA-STD-BASE-CXA15
 C12606_LENINA-DL

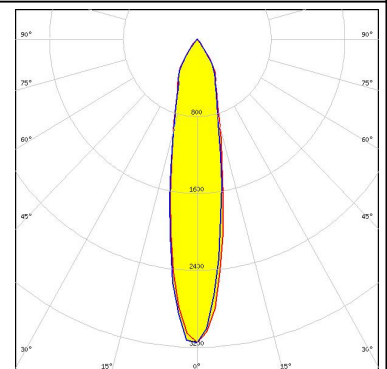
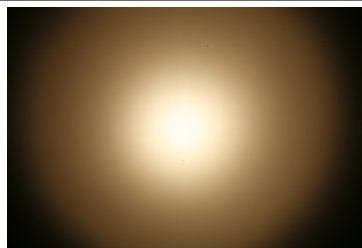

LED CXA/B 15xx
 FWHM 17.0°
 Efficiency 91 %
 Peak intensity 4.1 cd/lm
 LEDs/each optic 1
 Light colour White
 Required components:
 C13186_LENINA-STD-BASE-CXA15

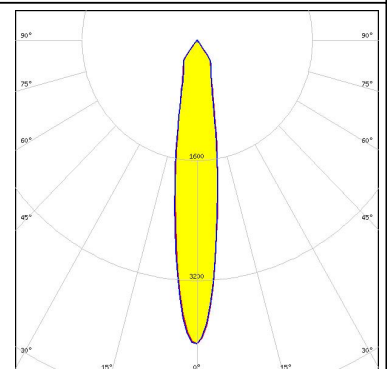

PHOTOMETRIC DATA (MEASURED):

CREE

LED CXA/B 15xx
 FWHM 22.0°
 Efficiency %
 Peak intensity 3.1 cd/lm
 LEDs/each optic 1
 Light colour White
 Required components:
 C13868_LENINA-STD-BASE-VERO13-18
 Bender Wirth: 441 Typ L1

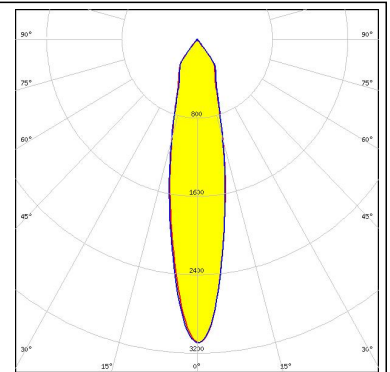
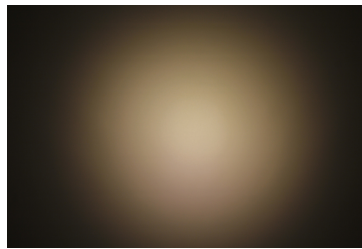

CREE

LED CXA/B 1816 & CXA/B 1820 & CXA 1850
 FWHM 29.0°
 Efficiency 88 %
 Peak intensity 2.1 cd/lm
 LEDs/each optic 1
 Light colour White
 Required components:
 C13868_LENINA-STD-BASE-VERO13-18
 C12606_LENINA-DL
 Bender Wirth: 437 Typ L1

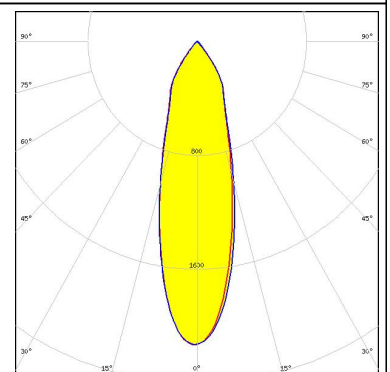
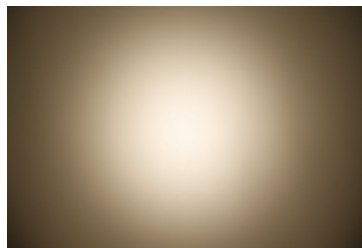

CREE

LED CXA/B 1816 & CXA/B 1820 & CXA 1850
 FWHM 21.0°
 Efficiency 92 %
 Peak intensity 3.9 cd/lm
 LEDs/each optic 1
 Light colour White
 Required components:
 C14146_LENINA-STD-BASE-CXA18

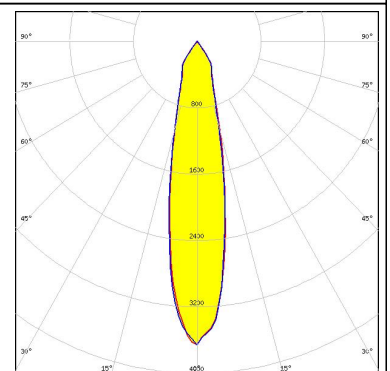
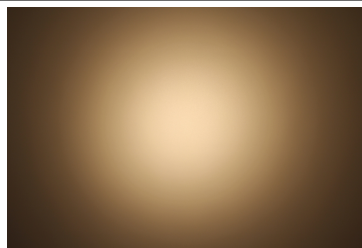

CREE

LED CXA/B 1816 & CXA/B 1820 & CXA 1850
 FWHM 26.0°
 Efficiency 92 %
 Peak intensity 2.6 cd/lm
 LEDs/each optic 1
 Light colour White
 Required components:
 C13868_LENINA-STD-BASE-VERO13-18
 Bender Wirth: 437 Typ L1

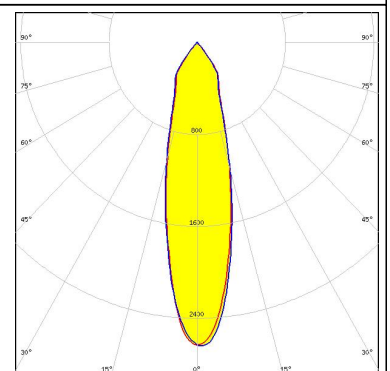
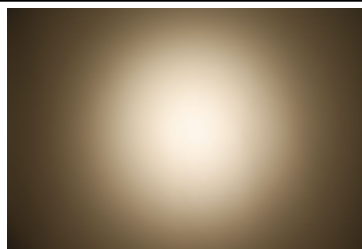

PHOTOMETRIC DATA (MEASURED):

CREE 

LED CXA/B 1830
 FWHM 33.0°
 Efficiency 88 %
 Peak intensity 1.9 cd/lm
 LEDs/each optic 1
 Light colour White

Required components:
 C13868_LENINA-STD-BASE-VERO13-18
 C12606_LENINA-DL
 Bender Wirth: 437 Typ L1

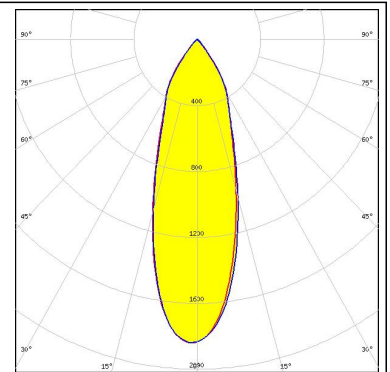

CREE 

LED CXA/B 1830
 FWHM 30.0°
 Efficiency 93 %
 Peak intensity 2.3 cd/lm
 LEDs/each optic 1
 Light colour White

Required components:
 C13868_LENINA-STD-BASE-VERO13-18
 Bender Wirth: 437 Typ L1

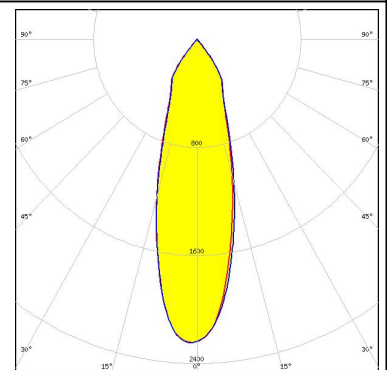
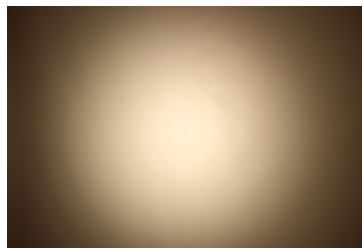

CREE 

LED CXA/B 25xx
 FWHM 35.0°
 Efficiency 78 %
 Peak intensity 1.6 cd/lm
 LEDs/each optic 1
 Light colour White

Required components:
 C13324_LENINA-STD-BASE-CXA25
 C12606_LENINA-DL

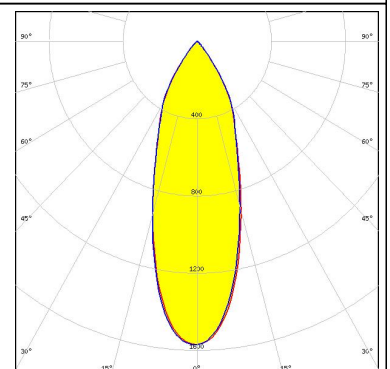
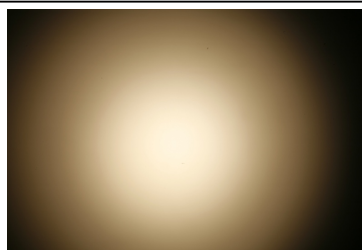

CREE 

LED CXA/B 25xx
 FWHM 33.0°
 Efficiency 86 %
 Peak intensity 1.9 cd/lm
 LEDs/each optic 1
 Light colour White

Required components:
 C13324_LENINA-STD-BASE-CXA25

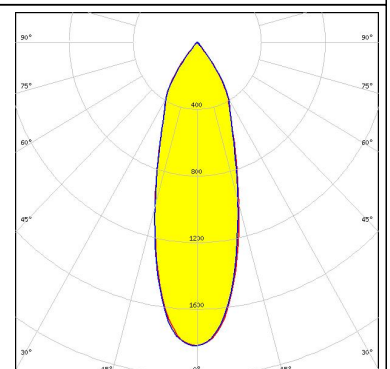
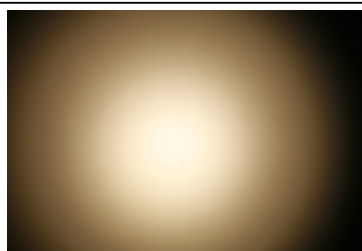

PHOTOMETRIC DATA (MEASURED):

CREE

LED CXA2011
 FWHM 28.0°
 Efficiency 85 %
 Peak intensity 2.2 cd/lm
 LEDs/each optic 1
 Light colour White
 Required components:
 C12105_LENINA-STD-BASE-CXA20

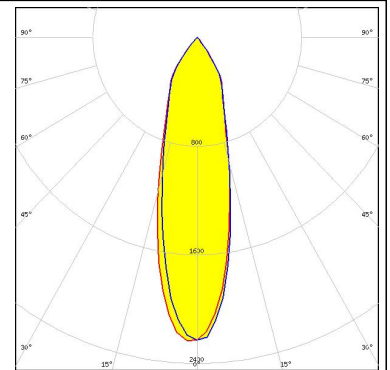

CREE

LED CXA2011
 FWHM 33.0°
 Efficiency 77 %
 Peak intensity 1.8 cd/lm
 LEDs/each optic 1
 Light colour White
 Required components:
 C12105_LENINA-STD-BASE-CXA20
 C12606_LENINA-DL

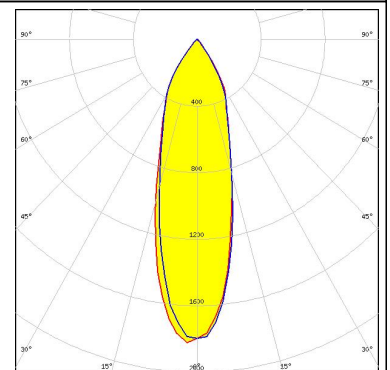

EVERLIGHT

LED CHI3030 19W
 FWHM 39.0°
 Efficiency 91 %
 Peak intensity 1.5 cd/lm
 LEDs/each optic 1
 Light colour White
 Required components:
 C13867_LENINA-STD-BASE-VERO29
 C12606_LENINA-DL
 Bender Wirth: 468 Typ L3

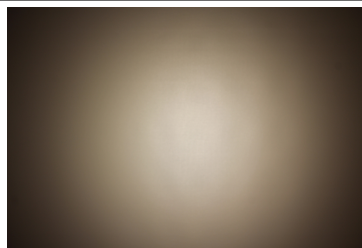



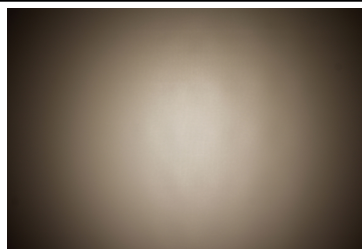

EVERLIGHT

LED CHI3030 29W
 FWHM 47.0°
 Efficiency 87 %
 Peak intensity 1.2 cd/lm
 LEDs/each optic 1
 Light colour White
 Required components:
 C13867_LENINA-STD-BASE-VERO29
 C12606_LENINA-DL
 Bender Wirth: 468 Typ L3

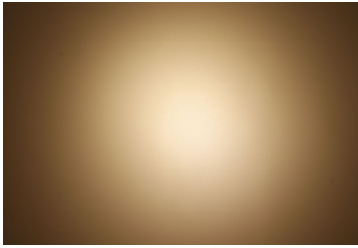
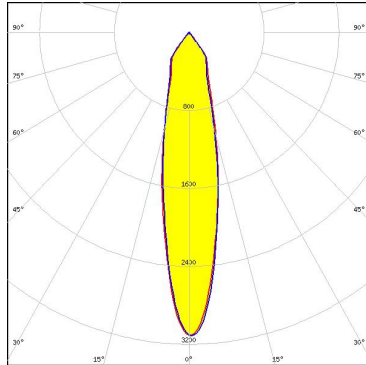
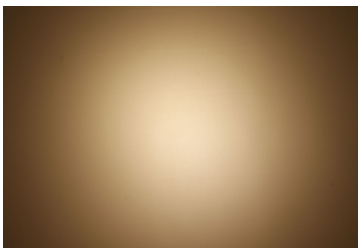
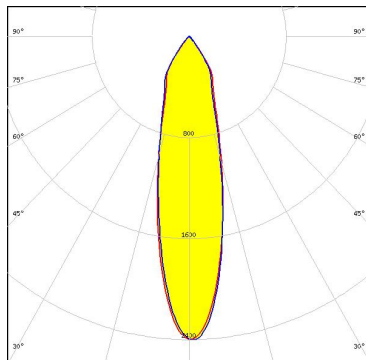

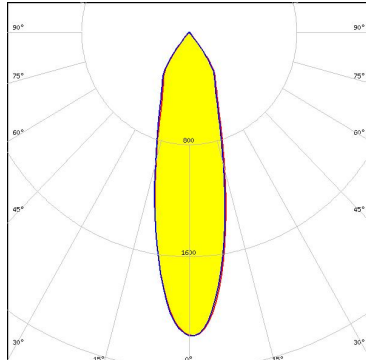
PHOTOMETRIC DATA (MEASURED):

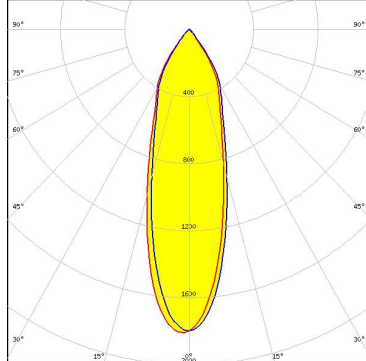
<p>LUMILEDS</p> <p>LED LUXEON CoB 1202/1203 FWHM 22.0° Efficiency 92 % Peak intensity 3.1 cd/lm LEDs/each optic 1 Light colour White Required components: C13868_LENINA-STD-BASE-VERO13-18 Bender Wirth: 438 Typ L1</p>		
<p>LUMILEDS</p> <p>LED LUXEON CoB 1202/1203 FWHM 26.0° Efficiency 88 % Peak intensity 2.4 cd/lm LEDs/each optic 1 Light colour White Required components: C13868_LENINA-STD-BASE-VERO13-18 C12606_LENINA-DL Bender Wirth: 438 Typ L1</p>		
<p>LUMILEDS</p> <p>LED LUXEON CoB 1204/1205 FWHM 28.0° Efficiency 87 % Peak intensity 2.2 cd/lm LEDs/each optic 1 Light colour White Required components: C12292_LENINA-STD-BASE-MEZ</p>		
<p>LUMILEDS</p> <p>LED LUXEON CoB 1204/1205 FWHM 30.0° Efficiency 82 % Peak intensity 1.8 cd/lm LEDs/each optic 1 Light colour White Required components: C12292_LENINA-STD-BASE-MEZ C12606_LENINA-DL</p>		

PHOTOMETRIC DATA (MEASURED):

LUMILEDS

LED LUXEON CoB 1204HD
 FWHM 20.0°
 Efficiency 92 %
 Peak intensity 3.5 cd/lm
 LEDs/each optic 1
 Light colour White
 Required components:
 C11981_LENINA-STD-BASE-COB-L110

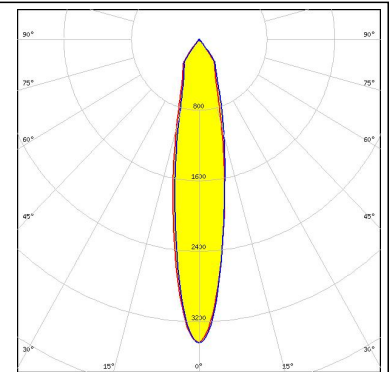

LUMILEDS

LED LUXEON CoB 1205HD
 FWHM 23.0°
 Efficiency 92 %
 Peak intensity 3 cd/lm
 LEDs/each optic 1
 Light colour White
 Required components:
 C11981_LENINA-STD-BASE-COB-L110

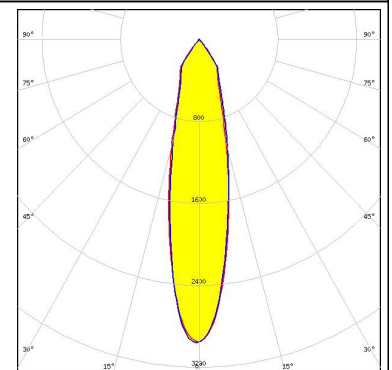
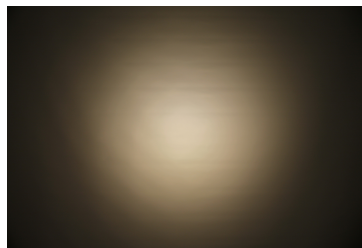

LUMILEDS

LED LUXEON CoB 1208
 FWHM 31.0°
 Efficiency 88 %
 Peak intensity 2 cd/lm
 LEDs/each optic 1
 Light colour White
 Required components:
 C12292_LENINA-STD-BASE-MEZ

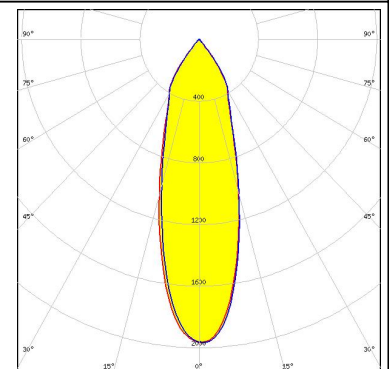
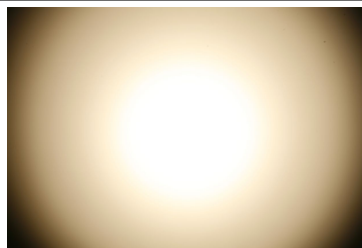

LUMILEDS

LED LUXEON CoB 1208
 FWHM 33.0°
 Efficiency 83 %
 Peak intensity 1.7 cd/lm
 LEDs/each optic 1
 Light colour White
 Required components:
 C12292_LENINA-STD-BASE-MEZ
 C12606_LENINA-DL

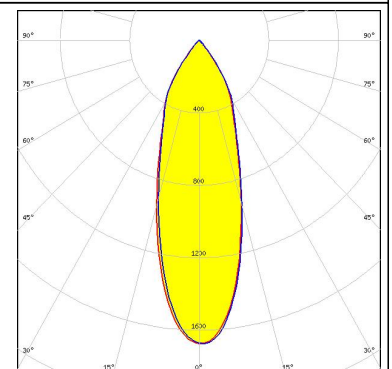
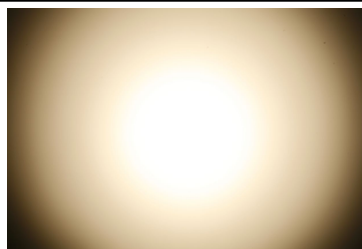

PHOTOMETRIC DATA (MEASURED):

LUMILEDS

LED LUXEON CoB 1211
 FWHM 35.0°
 Efficiency 93 %
 Peak intensity 1.9 cd/lm
 LEDs/each optic 1
 Light colour White
 Required components:
 C13867_LENINA-STD-BASE-VERO29
 Bender Wirth: 431 Typ L3

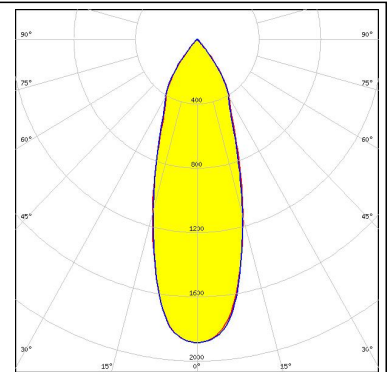
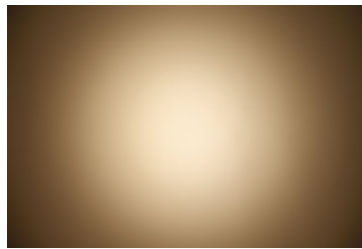

LUMILEDS

LED LUXEON CoB 1211
 FWHM 37.0°
 Efficiency 87 %
 Peak intensity 1.6 cd/lm
 LEDs/each optic 1
 Light colour White
 Required components:
 C13867_LENINA-STD-BASE-VERO29
 C12606_LENINA-DL
 Bender Wirth: 431 Typ L3

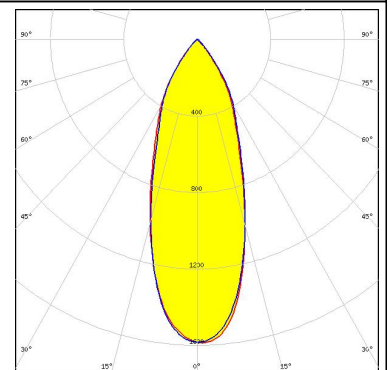
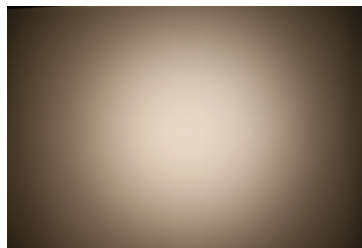

LUMILEDS

LED LUXEON CoB 1216/1812
 FWHM 39.0°
 Efficiency 81 %
 Peak intensity 1.4 cd/lm
 LEDs/each optic 1
 Light colour White
 Required components:
 C12606_LENINA-DL
 A.A.G. STUCCHI: 8102/G2 + S-8000/12

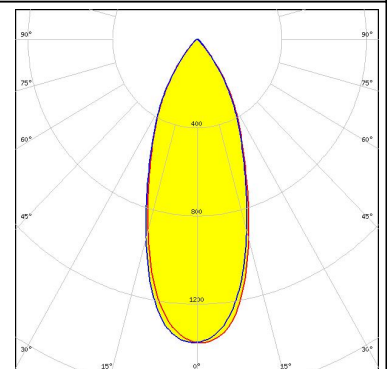
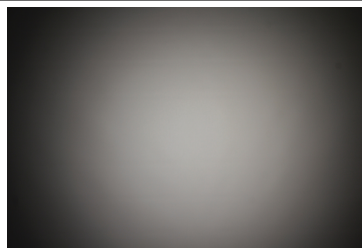



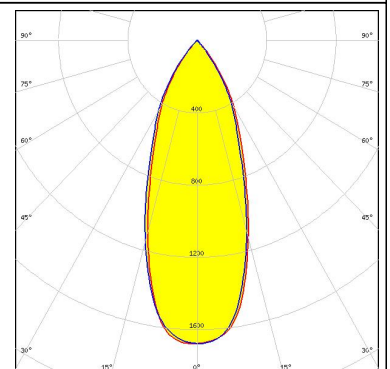
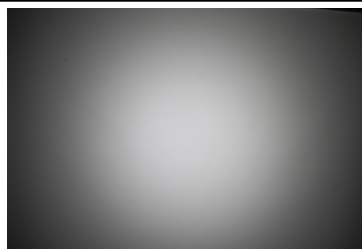

LUMILEDS

LED LUXEON CoB 1216/1812
 FWHM 39.0°
 Efficiency 92 %
 Peak intensity 1.7 cd/lm
 LEDs/each optic 1
 Light colour White
 Required components:
 C12692_LENINA-STD-BASE-CLL040

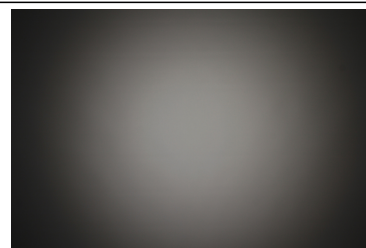
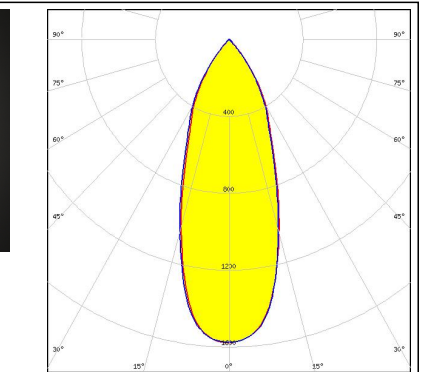
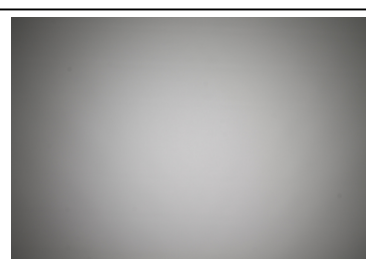
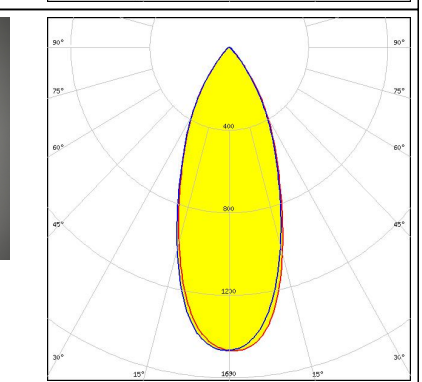

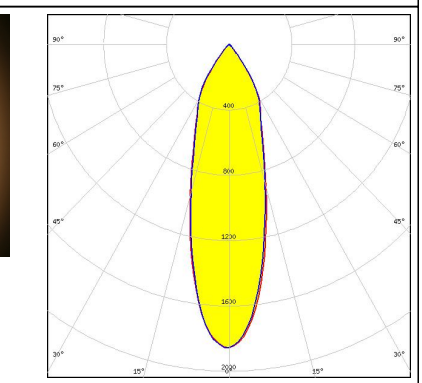
PHOTOMETRIC DATA (MEASURED):

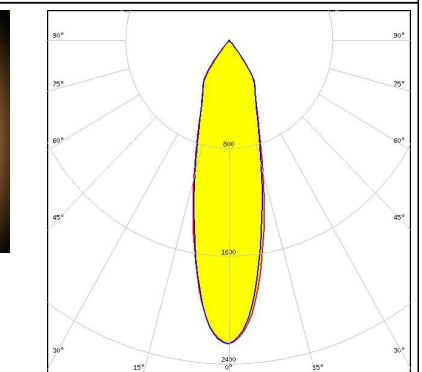
<p>LUMILEDS</p> <p>LED LUXEON CoB 1216/1812 FWHM 38.0° Efficiency 85 % Peak intensity 1.6 cd/lm LEDs/each optic 1 Light colour White Required components: A.A.G. STUCCHI: 8102/G2 + S-8000/12</p>		
<p>LUMILEDS</p> <p>LED LUXEON CoB 1216/1812 FWHM 40.0° Efficiency 88 % Peak intensity 1.5 cd/lm LEDs/each optic 1 Light colour White Required components: C12692_LENINA-STD-BASE-CLL040 C12606_LENINA-DL</p>		
<p>LUMILEDS</p> <p>LED LUXEON K12 FWHM 30.0° Efficiency 83 % Peak intensity 1.9 cd/lm LEDs/each optic 1 Light colour White Required components: C12924_LENINA-STD-BASE-LUXEON-K C12606_LENINA-DL</p>		
<p>LUMILEDS</p> <p>LED LUXEON K12 FWHM 28.0° Efficiency 89 % Peak intensity 2.3 cd/lm LEDs/each optic 1 Light colour White Required components: C12924_LENINA-STD-BASE-LUXEON-K</p>		

PHOTOMETRIC DATA (MEASURED):



LED LUXEON K16
 FWHM 30.0°
 Efficiency 85 %
 Peak intensity 2 cd/lm
 LEDs/each optic 1
 Light colour White
 Required components:
 C12924_LENINA-STD-BASE-LUXEON-K

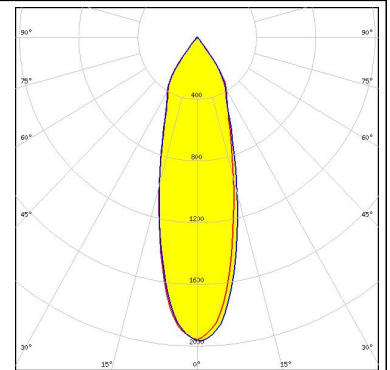
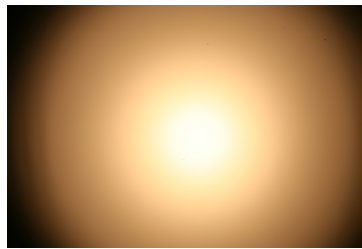

LED LUXEON K16
 FWHM 34.0°
 Efficiency 79 %
 Peak intensity 1.5 cd/lm
 LEDs/each optic 1
 Light colour White
 Required components:
 C12924_LENINA-STD-BASE-LUXEON-K
 C12606_LENINA-DL

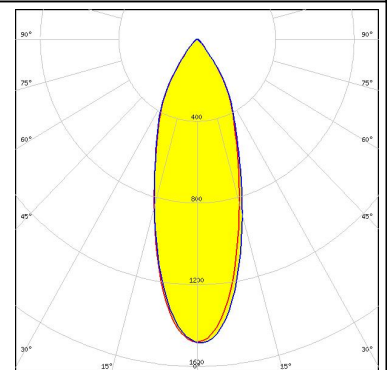
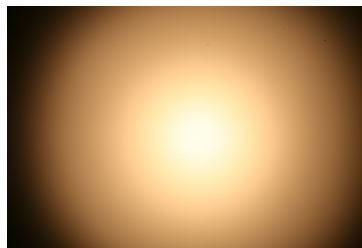

LED CDM-14 (Dim-To-Warm)
 FWHM 31.0°
 Efficiency 88 %
 Peak intensity 1.9 cd/lm
 LEDs/each optic 1
 Light colour White
 Required components:
 C13868_LENINA-STD-BASE-VERO13-18
 C12606_LENINA-DL
 Bender Wirth: 491 Typ L2

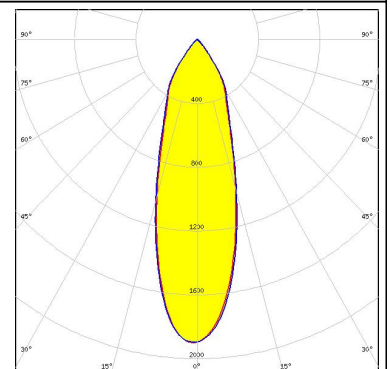
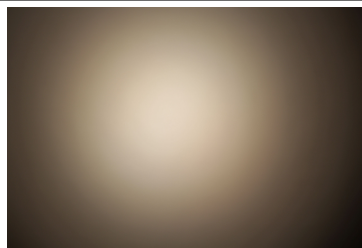

LED CDM-14 (Dim-To-Warm)
 FWHM 29.0°
 Efficiency 92 %
 Peak intensity 2.3 cd/lm
 LEDs/each optic 1
 Light colour White
 Required components:
 C13868_LENINA-STD-BASE-VERO13-18
 Bender Wirth: 491 Typ L2

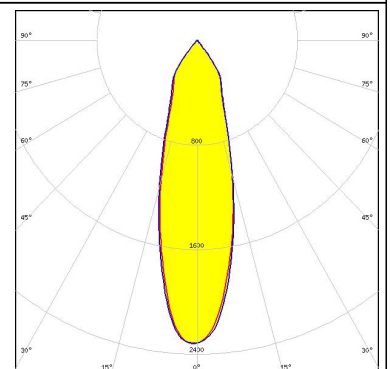
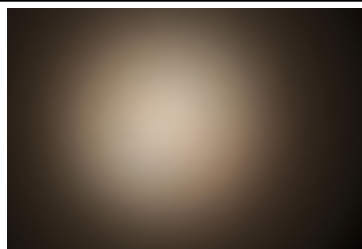

PHOTOMETRIC DATA (MEASURED):



LED CDM-18 (Dim-To-Warm)
 FWHM 34.0°
 Efficiency 92 %
 Peak intensity 2 cd/lm
 LEDs/each optic 1
 Light colour White
 Required components:
 C13868_LENINA-STD-BASE-VERO13-18
 Bender Wirth: 491 Typ L2

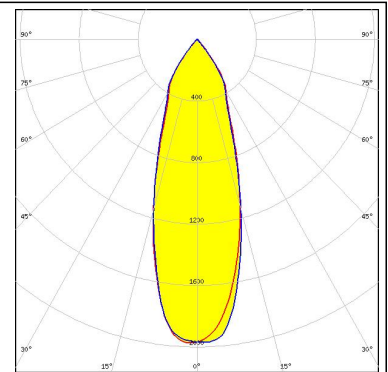
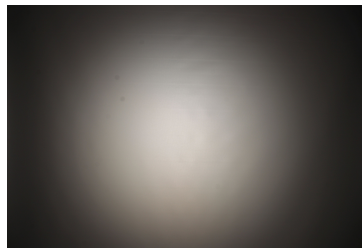

LED CDM-18 (Dim-To-Warm)
 FWHM 36.0°
 Efficiency 88 %
 Peak intensity 1.7 cd/lm
 LEDs/each optic 1
 Light colour White
 Required components:
 C13868_LENINA-STD-BASE-VERO13-18
 C12606_LENINA-DL
 Bender Wirth: 491 Typ L2

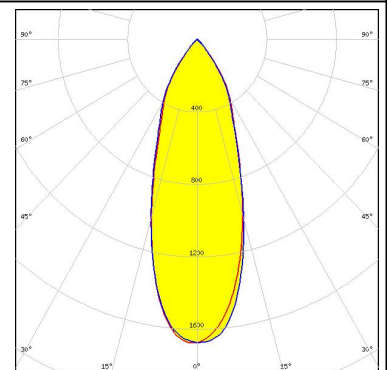
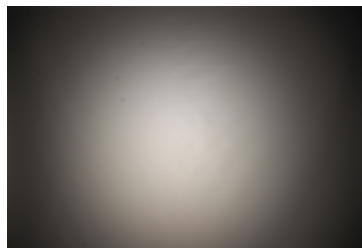

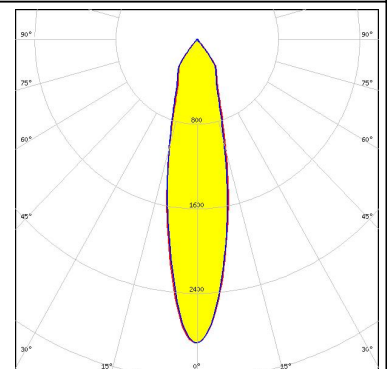
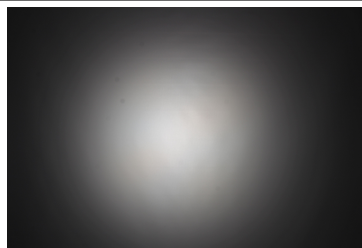

LED CDM-9 (Dim-To-Warm)
 FWHM 24.0°
 Efficiency 92 %
 Peak intensity 2.9 cd/lm
 LEDs/each optic 1
 Light colour White
 Required components:
 C13868_LENINA-STD-BASE-VERO13-18
 Bender Wirth: 490 Typ L1

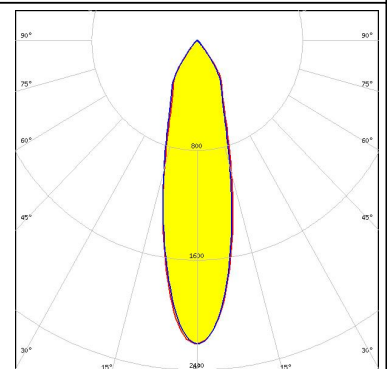
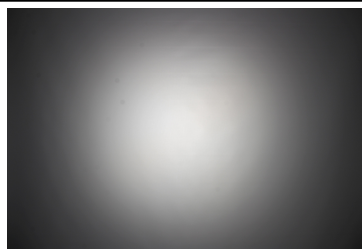

LED CDM-9 (Dim-To-Warm)
 FWHM 27.0°
 Efficiency 87 %
 Peak intensity 2.2 cd/lm
 LEDs/each optic 1
 Light colour White
 Required components:
 C13868_LENINA-STD-BASE-VERO13-18
 C12606_LENINA-DL
 Bender Wirth: 490 Typ L1

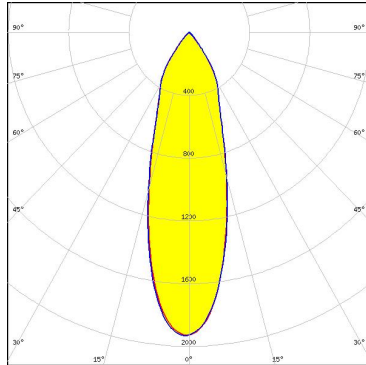

PHOTOMETRIC DATA (MEASURED):

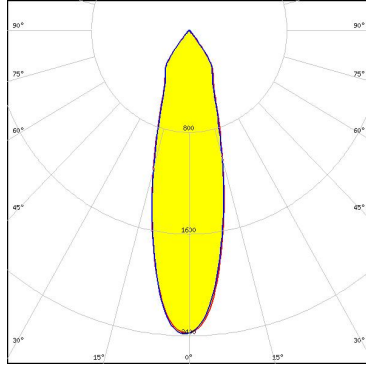
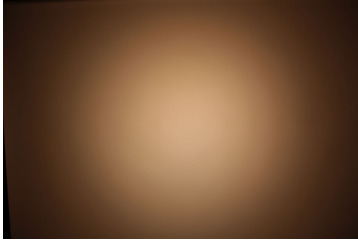
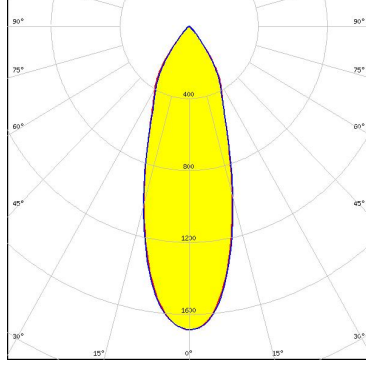
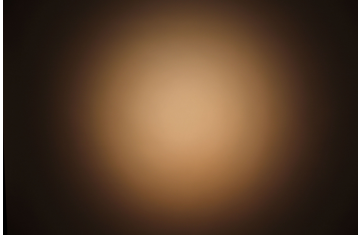
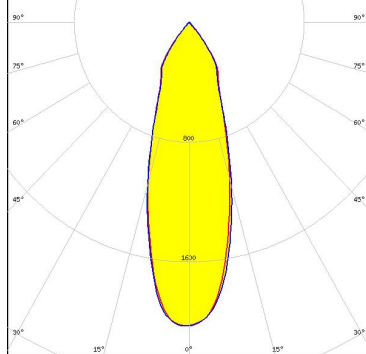
<p>LUMINUS</p> <p>LED CTM-14 (Tunable White) FWHM 31.0° Efficiency 87 % Peak intensity 1.9 cd/lm LEDs/each optic 1 Light colour White</p> <p>Required components: C13867_LENINA-STD-BASE-VERO29 C12606_LENINA-DL Bender Wirth: 442 Typ L3</p>		
<p>LUMINUS</p> <p>LED CTM-14 (Tunable White) FWHM 28.0° Efficiency 92 % Peak intensity 2.4 cd/lm LEDs/each optic 1 Light colour White</p> <p>Required components: C13867_LENINA-STD-BASE-VERO29 Bender Wirth: 442 Typ L3</p>		
<p>LUMINUS</p> <p>LED CTM-18 (Tunable White) FWHM 34.0° Efficiency 87 % Peak intensity 1.7 cd/lm LEDs/each optic 1 Light colour White</p> <p>Required components: C13867_LENINA-STD-BASE-VERO29 C12606_LENINA-DL Bender Wirth: 442 Typ L3</p>		
<p>LUMINUS</p> <p>LED CTM-18 (Tunable White) FWHM 32.0° Efficiency 92 % Peak intensity 2 cd/lm LEDs/each optic 1 Light colour White</p> <p>Required components: C13867_LENINA-STD-BASE-VERO29 Bender Wirth: 442 Typ L3</p>		

PHOTOMETRIC DATA (MEASURED):



LED CTM-22 (Tunable White)
 FWHM 40.0°
 Efficiency 87 %
 Peak intensity 1.4 cd/lm
 LEDs/each optic 1
 Light colour White
 Required components:
 C13867_LENINA-STD-BASE-VERO29
 C12606_LENINA-DL
 Bender Wirth: 494 Typ L3

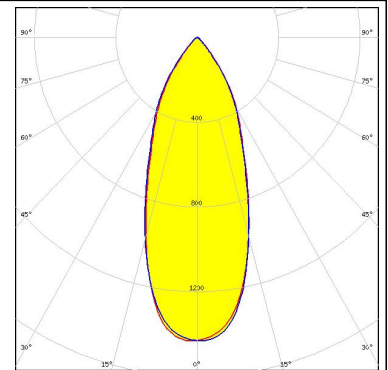

LED CTM-22 (Tunable White)
 FWHM 39.0°
 Efficiency 92 %
 Peak intensity 1.6 cd/lm
 LEDs/each optic 1
 Light colour White
 Required components:
 C13867_LENINA-STD-BASE-VERO29
 Bender Wirth: 494 Typ L3

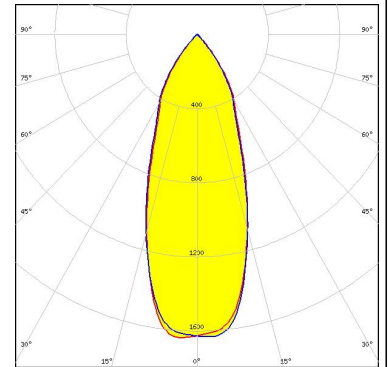
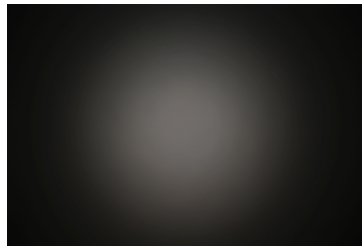

LED CxM-14 (19x19)
 FWHM 31.0°
 Efficiency 89 %
 Peak intensity 2.1 cd/lm
 LEDs/each optic 1
 Light colour White
 Required components:
 C12691_LENINA-STD-BASE-CLL030
 C12606_LENINA-DL

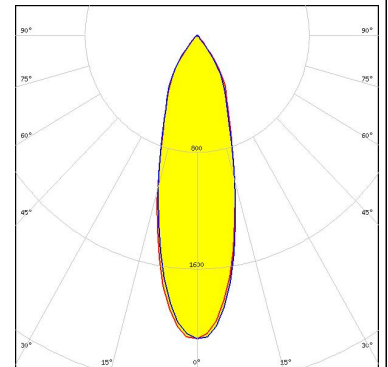
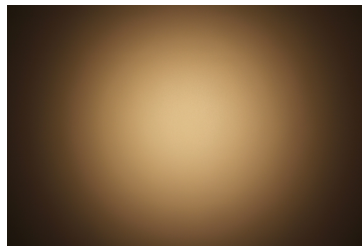

LED CxM-14 (19x19)
 FWHM 28.0°
 Efficiency 93 %
 Peak intensity 2.5 cd/lm
 LEDs/each optic 1
 Light colour White
 Required components:
 C12691_LENINA-STD-BASE-CLL030

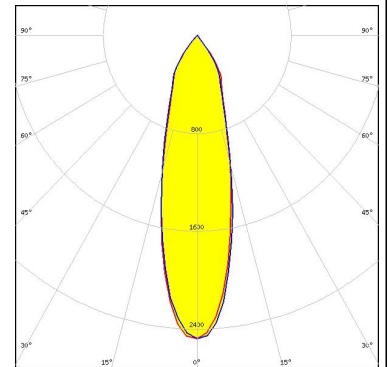
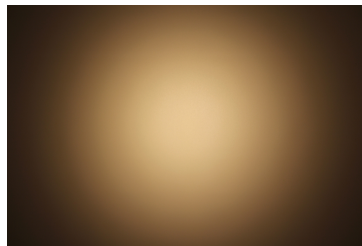

PHOTOMETRIC DATA (MEASURED):

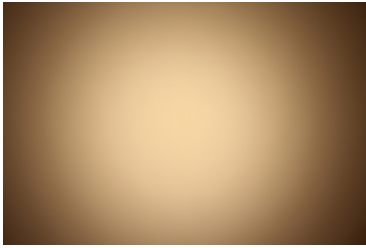
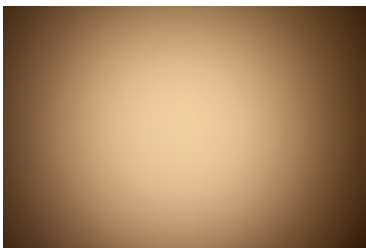
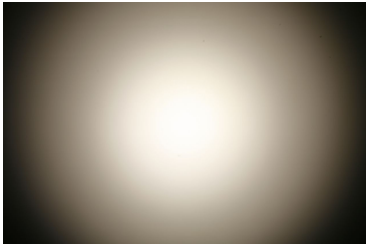
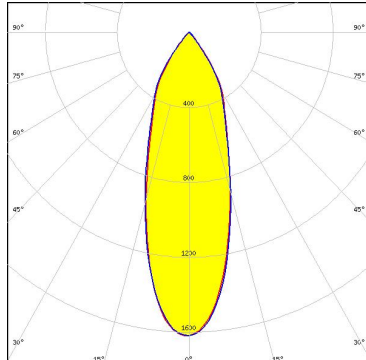
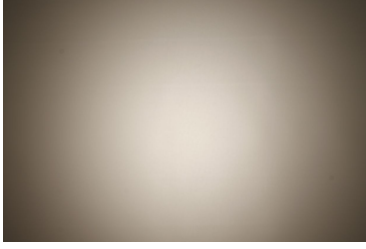
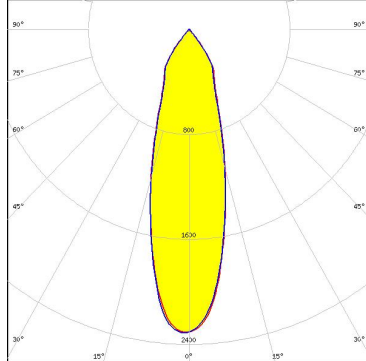
<p>LUMINUS</p> <p>LED CxM-22 (28x28) FWHM 39.0° Efficiency 92 % Peak intensity 1.8 cd/lm LEDs/each optic 1 Light colour White Required components: C12692_LENINA-STD-BASE-CLL040</p>		
<p>LUMINUS</p> <p>LED CxM-22 (28x28) FWHM 40.0° Efficiency 89 % Peak intensity 1.6 cd/lm LEDs/each optic 1 Light colour White Required components: C12692_LENINA-STD-BASE-CLL040 C12606_LENINA-DL</p>		
<p>NICHIA</p> <p>LED COB J-Type FWHM 33.0° Efficiency 81 % Peak intensity 1.6 cd/lm LEDs/each optic 1 Light colour White Required components: C12292_LENINA-STD-BASE-MEZ C12606_LENINA-DL</p>		
<p>NICHIA</p> <p>LED COB J-Type FWHM 29.0° Efficiency 93 % Peak intensity 2.3 cd/lm LEDs/each optic 1 Light colour White Required components: C13868_LENINA-STD-BASE-VERO13-18 Bender Wirth: 463 Typ L2</p>		

PHOTOMETRIC DATA (MEASURED):



LED COB J-Type
 FWHM 32.0°
 Efficiency 89 %
 Peak intensity 1.9 cd/lm
 LEDs/each optic 1
 Light colour White
 Required components:
 C13868_LENASTD-BASE-VERO13-18
 C12606_LENINA-DL

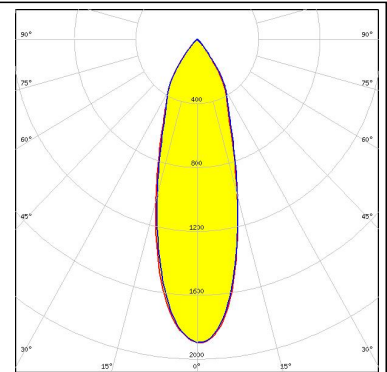
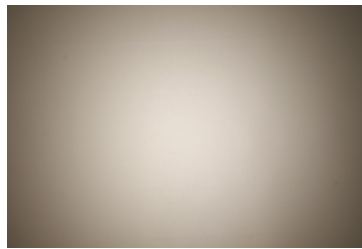

LED COB J-Type
 FWHM 31.0°
 Efficiency 86 %
 Peak intensity 1.9 cd/lm
 LEDs/each optic 1
 Light colour White
 Required components:
 C12292_LENASTD-BASE-MEZ

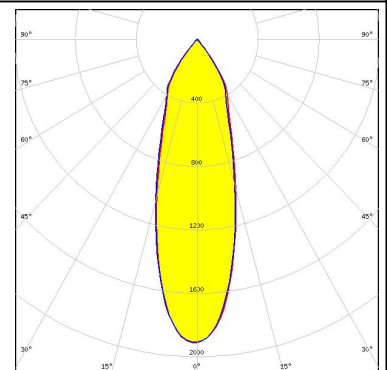
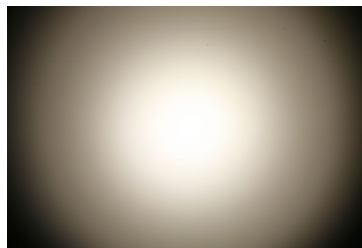

LED COB L-Type (LES 11)
 FWHM 29.0°
 Efficiency 79 %
 Peak intensity 1.8 cd/lm
 LEDs/each optic 1
 Light colour White
 Required components:
 C11981_LENASTD-BASE-COB-L110
 C12606_LENINA-DL

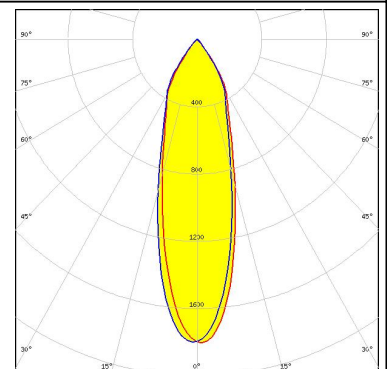
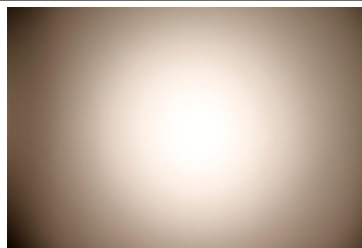

LED COB L-Type (LES 11)
 FWHM 28.0°
 Efficiency 87 %
 Peak intensity 2.2 cd/lm
 LEDs/each optic 1
 Light colour White
 Required components:
 C13868_LENASTD-BASE-VERO13-18
 C12606_LENINA-DL
 Bender Wirth: 438 Typ L1

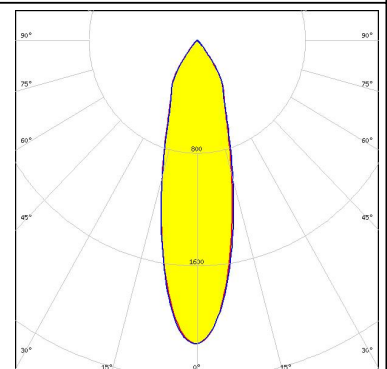
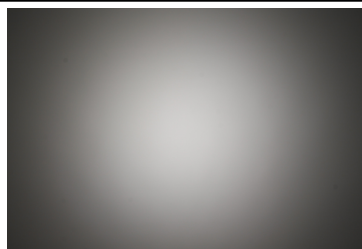

PHOTOMETRIC DATA (MEASURED):



LED COB L-Type (LES 11)
 FWHM 27.0°
 Efficiency 84 %
 Peak intensity 2.2 cd/lm
 LEDs/each optic 1
 Light colour White
 Required components:
 C11981_LENASTD-BASE-COB-L110

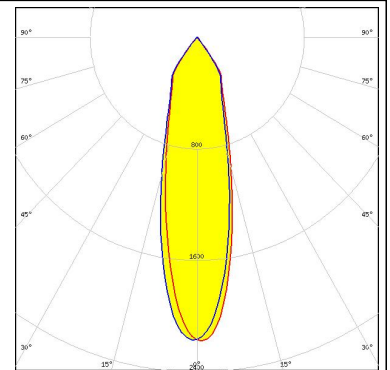
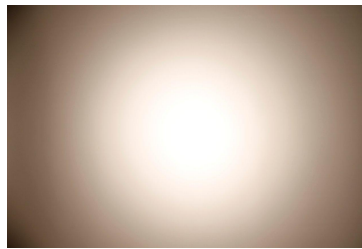

LED COB L-Type (LES 11)
 FWHM 25.0°
 Efficiency 91 %
 Peak intensity 2.7 cd/lm
 LEDs/each optic 1
 Light colour White
 Required components:
 C13868_LENASTD-BASE-VERO13-18
 Bender Wirth: 438 Typ L1

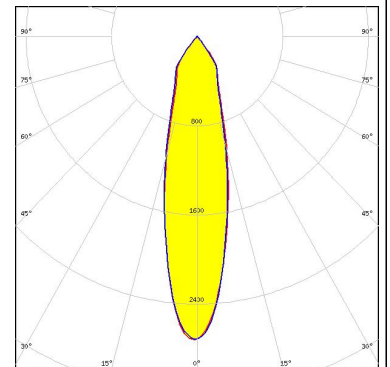

LED COB L-Type (LES 9)
 FWHM 26.0°
 Efficiency 89 %
 Peak intensity 2.4 cd/lm
 LEDs/each optic 1
 Light colour White
 Required components:
 C13868_LENASTD-BASE-VERO13-18
 C12606_LENINA-DL
 Bender Wirth: 438 Typ L1

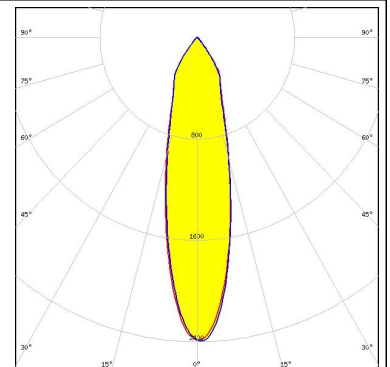
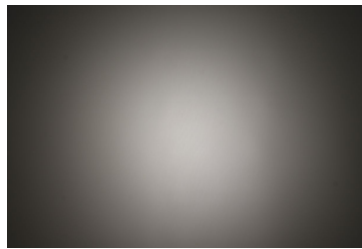

LED NVCWJ024Z-V1MT: COB J-Type Tunable White
 FWHM 29.0°
 Efficiency 87 %
 Peak intensity 2 cd/lm
 LEDs/each optic 1
 Light colour White
 Required components:
 C13868_LENASTD-BASE-VERO13-18
 C12606_LENINA-DL
 Bender Wirth: 498 Typ L2

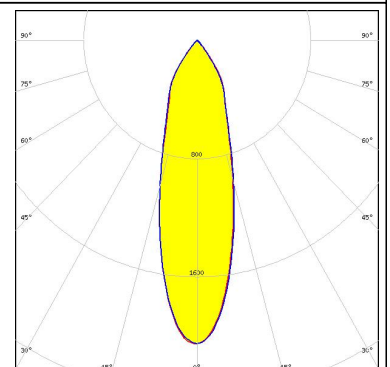
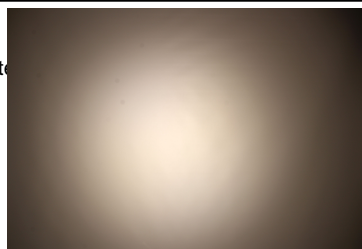

PHOTOMETRIC DATA (MEASURED):



LED NVCWJ024Z-V1MT: COB J-Type Tunable White
 FWHM 26.0°
 Efficiency 92 %
 Peak intensity 2.6 cd/lm
 LEDs/each optic 1
 Light colour White
 Required components:
 C13868_LENINA-STD-BASE-VERO13-18
 Bender Wirth: 498 Typ L2

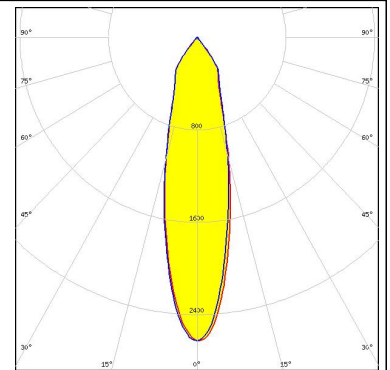
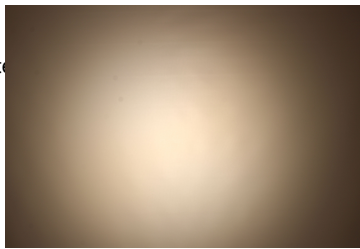

OSRAM Opto Semiconductors
 LED Soleriq S13
 FWHM 27.0°
 Efficiency 91 %
 Peak intensity 2.6 cd/lm
 LEDs/each optic 1
 Light colour White
 Required components:
 C13868_LENINA-STD-BASE-VERO13-18
 Bender Wirth: 437 Typ L1

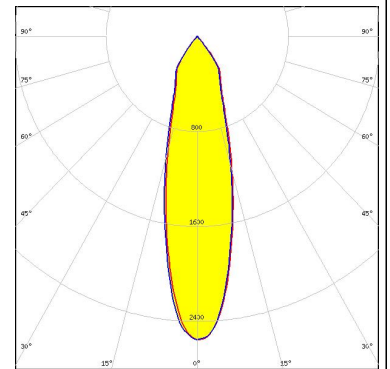
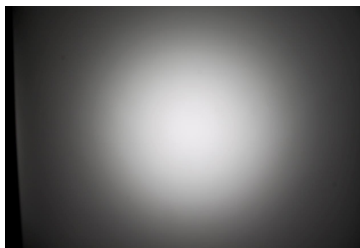

OSRAM Opto Semiconductors
 LED Soleriq S13
 FWHM 30.0°
 Efficiency 87 %
 Peak intensity 2 cd/lm
 LEDs/each optic 1
 Light colour White
 Required components:
 C13868_LENINA-STD-BASE-VERO13-18
 C12606_LENINA-DL
 Bender Wirth: 437 Typ L1

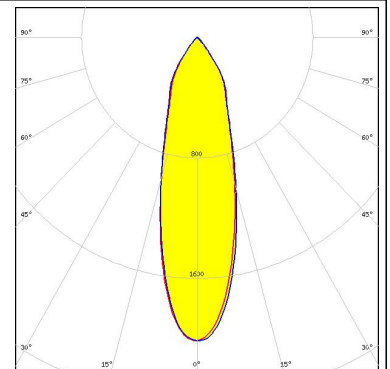
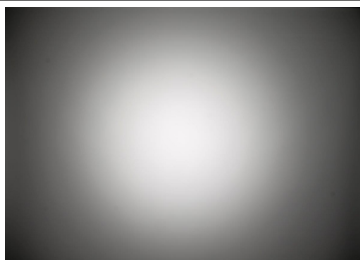

OSRAM Opto Semiconductors
 LED Soleriq S19
 FWHM 34.0°
 Efficiency 89 %
 Peak intensity 1.7 cd/lm
 LEDs/each optic 1
 Light colour White
 Required components:
 C13867_LENINA-STD-BASE-VERO29
 C12606_LENINA-DL
 Bender Wirth: 462 Typ L3

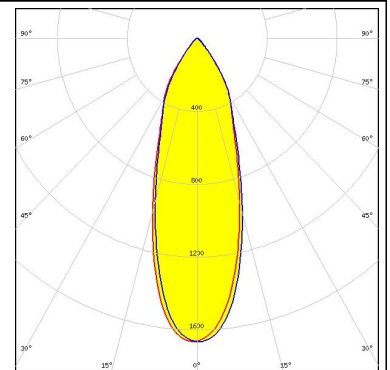
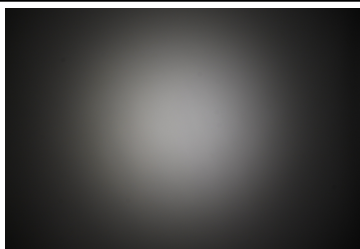

PHOTOMETRIC DATA (MEASURED):

OSRAM
Opto Semiconductors

LED Soleriq S19
 FWHM 32.0°
 Efficiency 93 %
 Peak intensity 2 cd/lm
 LEDs/each optic 1
 Light colour White
 Required components:
 C13867_LENINA-STD-BASE-VERO29
 Bender Wirth: 462 Typ L3

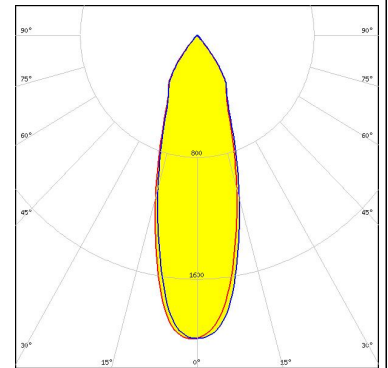

PHILIPS

LED Fortimo SLM L13 CoB
 FWHM 30.0°
 Efficiency 86 %
 Peak intensity 2 cd/lm
 LEDs/each optic 1
 Light colour White
 Required components:
 C12292_LENINA-STD-BASE-MEZ
 C12606_LENINA-DL

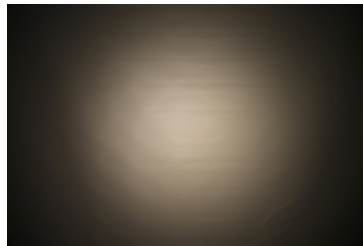

PHILIPS

LED Fortimo SLM L13 CoB
 FWHM 27.0°
 Efficiency 93 %
 Peak intensity 2.6 cd/lm
 LEDs/each optic 1
 Light colour White
 Required components:
 C12292_LENINA-STD-BASE-MEZ

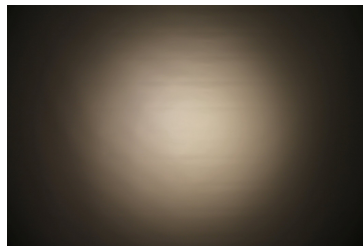

PHILIPS

LED Fortimo SLM L15 CoB
 FWHM 32.0°
 Efficiency 86 %
 Peak intensity 1.8 cd/lm
 LEDs/each optic 1
 Light colour White
 Required components:
 C12292_LENINA-STD-BASE-MEZ
 C12606_LENINA-DL

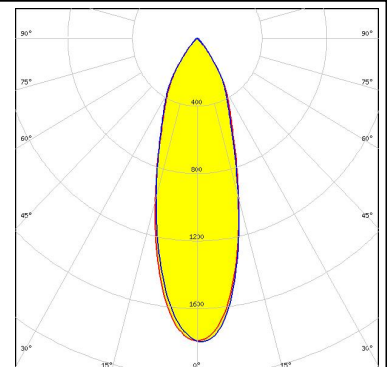
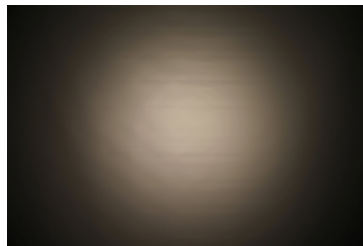

PHOTOMETRIC DATA (MEASURED):

PHILIPS

LED Fortimo SLM L15 CoB
 FWHM 29.0°
 Efficiency %
 Peak intensity 2.3 cd/lm
 LEDs/each optic 1
 Light colour White
 Required components:
 C12292_LENINA-STD-BASE-MEZ

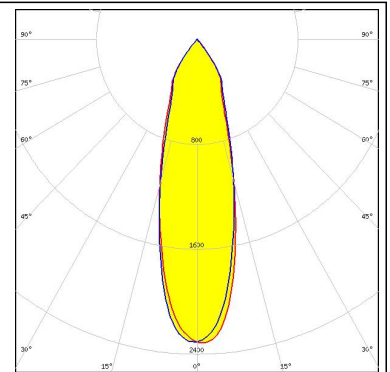

PHILIPS

LED Fortimo SLM L19 CoB
 FWHM 33.0°
 Efficiency 92 %
 Peak intensity 2 cd/lm
 LEDs/each optic 1
 Light colour White
 Required components:
 C12692_LENINA-STD-BASE-CLL040

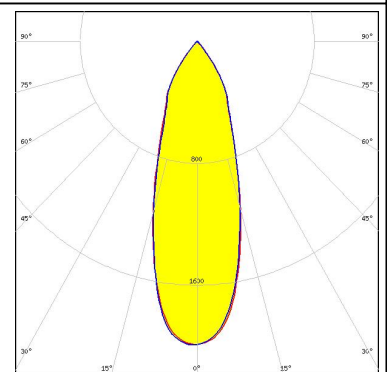
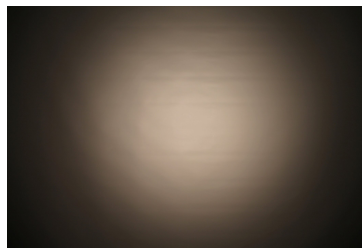

PHILIPS

LED Fortimo SLM L19 CoB
 FWHM 35.0°
 Efficiency 86 %
 Peak intensity 1.6 cd/lm
 LEDs/each optic 1
 Light colour White
 Required components:
 C12692_LENINA-STD-BASE-CLL040
 C12606_LENINA-DL

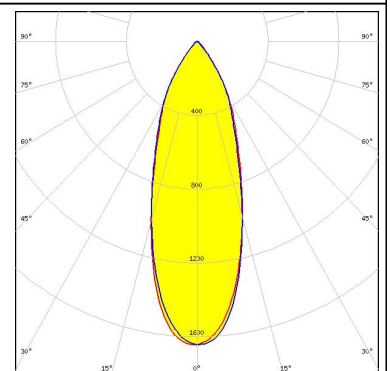
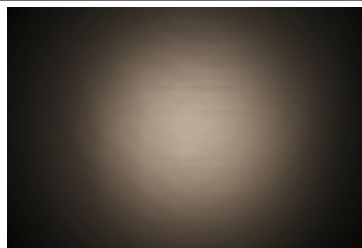

PHILIPS

LED Fortimo SLM L23 CoB
 FWHM 39.0°
 Efficiency 92 %
 Peak intensity 1.7 cd/lm
 LEDs/each optic 1
 Light colour White
 Required components:
 C12692_LENINA-STD-BASE-CLL040

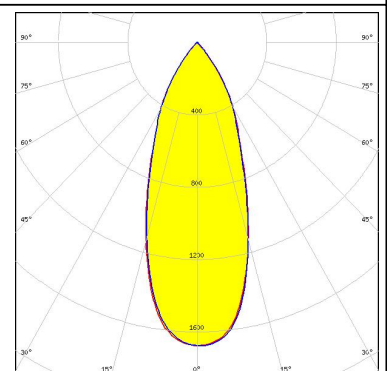
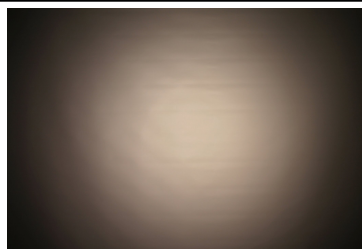

PHOTOMETRIC DATA (MEASURED):

PHILIPS

LED Fortimo SLM L23 CoB
 FWHM 40.0°
 Efficiency 86 %
 Peak intensity 1.4 cd/lm
 LEDs/each optic 1
 Light colour White
 Required components:
 C12692_LENINA-STD-BASE-CLL040
 C12606_LENINA-DL

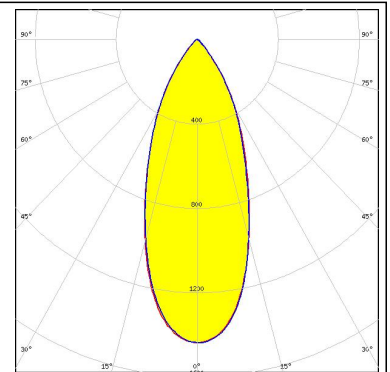
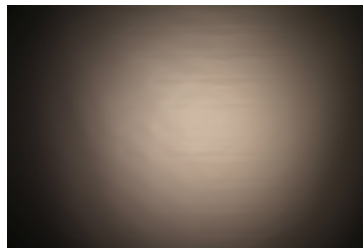

SAMSUNG

LED LC016D / LC019D / LC026D / LC033D
 FWHM 30.0°
 Efficiency 92 %
 Peak intensity 2.2 cd/lm
 LEDs/each optic 1
 Light colour White
 Required components:
 C12691_LENINA-STD-BASE-CLL030

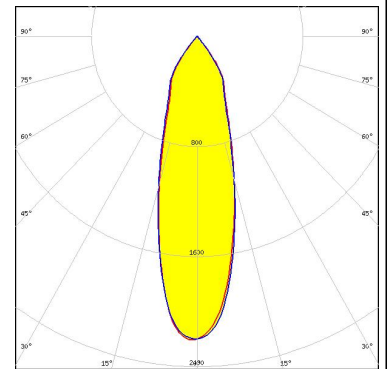
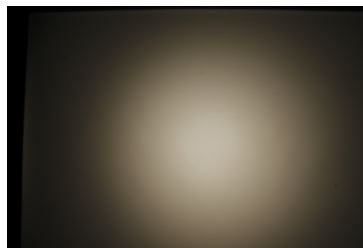

SAMSUNG

LED LC016D / LC019D / LC026D / LC033D
 FWHM 33.0°
 Efficiency 87 %
 Peak intensity 1.8 cd/lm
 LEDs/each optic 1
 Light colour White
 Required components:
 C12691_LENINA-STD-BASE-CLL030
 C12606_LENINA-DL

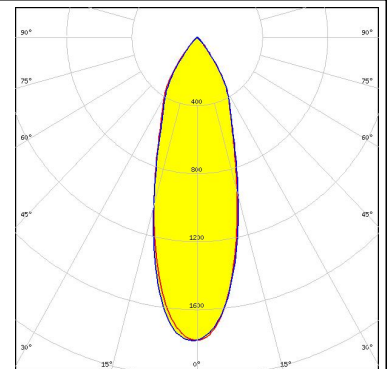
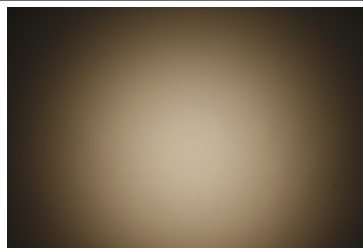

SAMSUNG

LED LC026B / 033B / 040B
 FWHM 33.0°
 Efficiency 92 %
 Peak intensity 2 cd/lm
 LEDs/each optic 1
 Light colour White
 Required components:
 C13868_LENINA-STD-BASE-VERO13-18
 Bender Wirth: 450 Typ L2

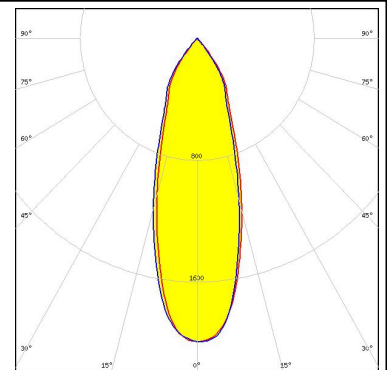
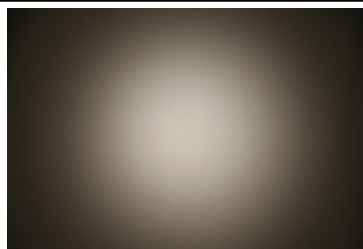

PHOTOMETRIC DATA (MEASURED):

SAMSUNG

LED LC026B / 033B / 040B
 FWHM 35.0°
 Efficiency 88 %
 Peak intensity 1.7 cd/lm
 LEDs/each optic 1
 Light colour White
 Required components:
 C13868_LENINA-STD-BASE-VERO13-18
 C12606_LENINA-DL
 Bender Wirth: 450 Typ L2

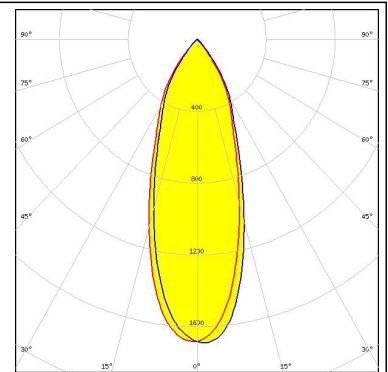
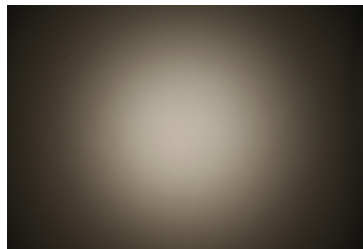

SAMSUNG

LED LC040D / LC060D / LC080D
 FWHM 40.0°
 Efficiency 91 %
 Peak intensity 1.6 cd/lm
 LEDs/each optic 1
 Light colour White
 Required components:
 C12692_LENINA-STD-BASE-CLL040

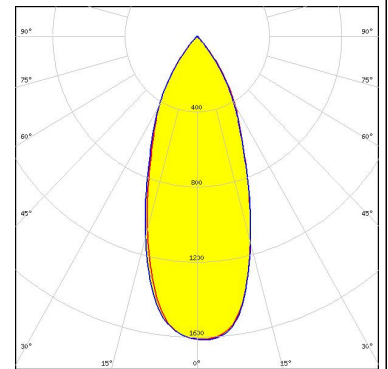
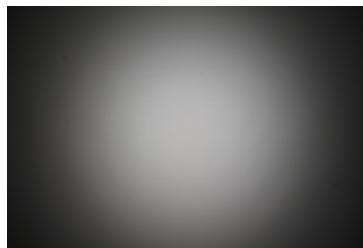

SAMSUNG

LED LC040D / LC060D / LC080D
 FWHM 41.0°
 Efficiency 87 %
 Peak intensity 1.4 cd/lm
 LEDs/each optic 1
 Light colour White
 Required components:
 C12692_LENINA-STD-BASE-CLL040
 C12606_LENINA-DL

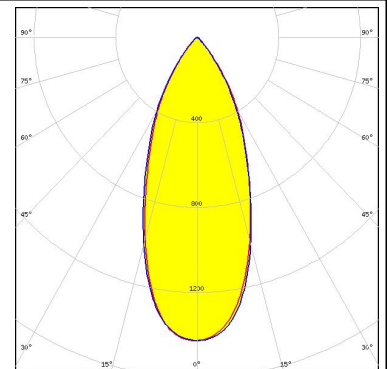
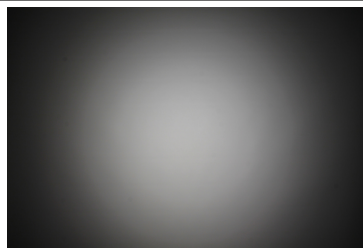

SEOL SEMICONDUCTOR

LED ZC25/40/60
 FWHM 42.0°
 Efficiency 85 %
 Peak intensity 1.4 cd/lm
 LEDs/each optic 1
 Light colour White
 Required components:
 C12692_LENINA-STD-BASE-CLL040

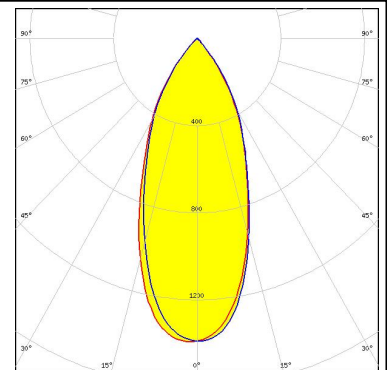
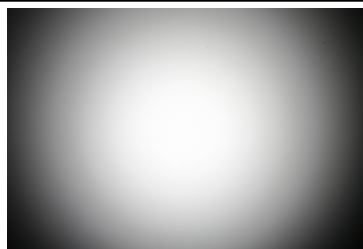

PHOTOMETRIC DATA (MEASURED):

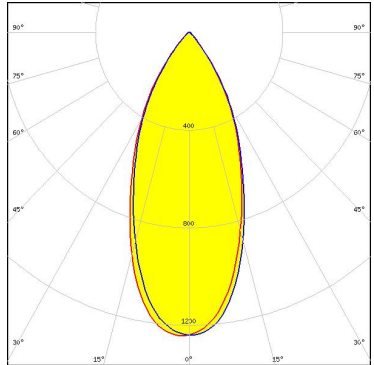
 SEOL SEMICONDUCTOR		
LED	ZC25/40/60	
FWHM	44.0°	
Efficiency	81 %	
Peak intensity	1.2 cd/lm	
LEDs/each optic	1	
Light colour	White	
Required components:		
	C12692_LENINA-STD-BASE-CLL040	
	C12606_LENINA-DL	
		

SHARP

LED	Mega Zenigata (GW5DGC)
FWHM	22.0°
Efficiency	78 %
LEDs/each optic	1
Light colour	White
Required components:	
	C12292_LENINA-STD-BASE-MEZ
	C12606_LENINA-DL

SHARP

LED	Mega Zenigata (GW5DGC)
FWHM	21.0°
Efficiency	86 %
LEDs/each optic	1
Light colour	White
Required components:	
	C12292_LENINA-STD-BASE-MEZ

SHARP

LED	Mega Zenigata (GW6DME)
FWHM	30.0°
Efficiency	87 %
Peak intensity	2 cd/lm
LEDs/each optic	1
Light colour	White
Required components:	
	C12292_LENINA-STD-BASE-MEZ

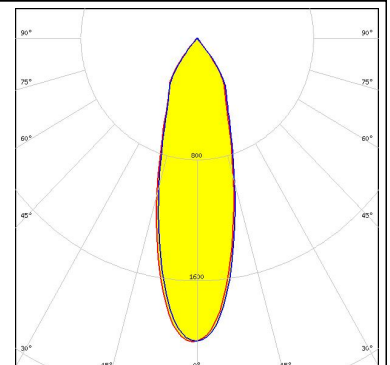
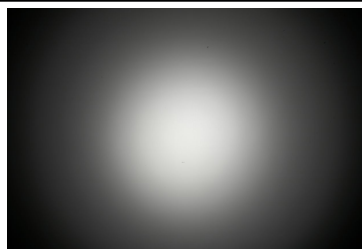

PHOTOMETRIC DATA (MEASURED):

SHARP

LED Mega Zenigata (GW6DME)
 FWHM 32.0°
 Efficiency 82 %
 Peak intensity 1.7 cd/lm
 LEDs/each optic 1
 Light colour White
 Required components:
 C12292_LENINA-STD-BASE-MEZ
 C12606_LENINA-DL

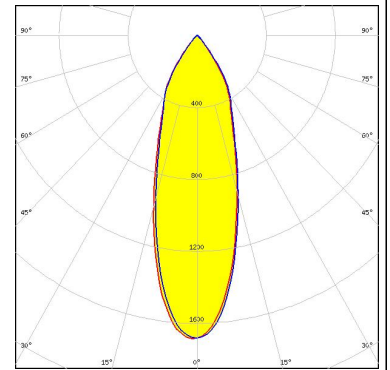

TRIDONIC

LED SLE G7 LES15
 FWHM 30.0°
 Efficiency 93 %
 Peak intensity 2.3 cd/lm
 LEDs/each optic 1
 Light colour White
 Required components:
 C12691_LENINA-STD-BASE-CLL030

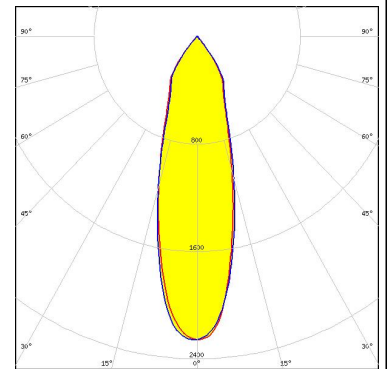

TRIDONIC

LED SLE G7 LES17 H
 FWHM 31.0°
 Efficiency 91 %
 Peak intensity 2.1 cd/lm
 LEDs/each optic 1
 Light colour White
 Required components:
 C14547_LENINA-ADAPTER-B

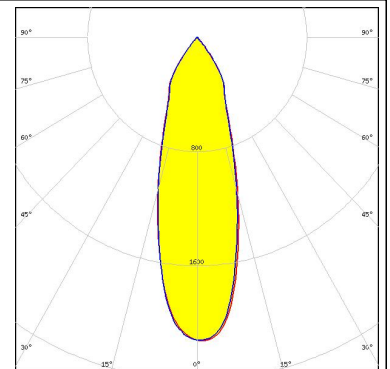

TRIDONIC

LED SLE G7 LES21 H
 FWHM 37.0°
 Efficiency 91 %
 Peak intensity 1.7 cd/lm
 LEDs/each optic 1
 Light colour White
 Required components:
 C14547_LENINA-ADAPTER-B

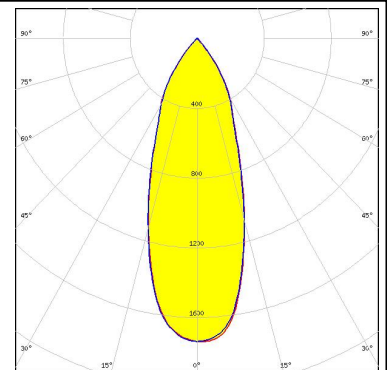
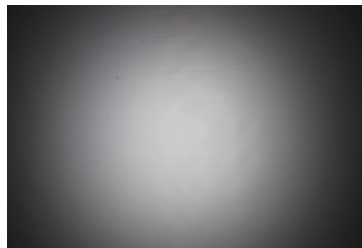

PHOTOMETRIC DATA (MEASURED):

XICATO

LED XOB 14.5 mm
FWHM 29.0°
Efficiency 93 %
Peak intensity 2.3 cd/lm
LEDs/each optic 1
Light colour White
Required components:
C12691_LENINA-STD-BASE-CLL030

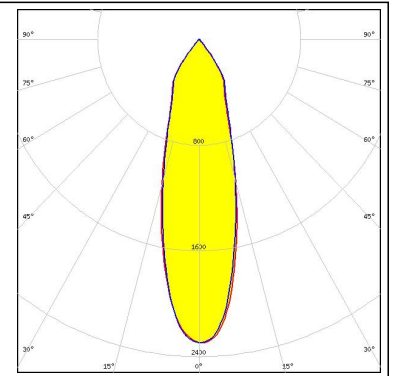

PHOTOMETRIC DATA (SIMULATED):

<p>bridgelux.</p> <p>LED V10 Gen7 FWHM 26.0° Efficiency 91 % Peak intensity 2.7 cd/lm LEDs/each optic 1 Light colour White</p> <p>Required components: C13868_LENINA-STD-BASE-VERO13-18 Bender Wirth: 486 Typ L1</p>	
<p>bridgelux.</p> <p>LED V10 Gen7 FWHM 28.0° Efficiency 86 % Peak intensity 2.3 cd/lm LEDs/each optic 1 Light colour White</p> <p>Required components: C13868_LENINA-STD-BASE-VERO13-18 C12606_LENINA-DL Bender Wirth: 486 Typ L1</p>	
<p>bridgelux.</p> <p>LED V13 Gen7 FWHM 31.0° Efficiency 90 % Peak intensity 2.3 cd/lm LEDs/each optic 1 Light colour White</p> <p>Required components: C13868_LENINA-STD-BASE-VERO13-18 Bender Wirth: 477 Typ L1</p>	
<p>bridgelux.</p> <p>LED V13 Gen7 FWHM 26.0° Efficiency 87 % Peak intensity 2.2 cd/lm LEDs/each optic 1 Light colour White</p> <p>Required components: C12606_LENINA-DL IDEAL: 50-2103CT + 50-2100AN</p>	

PHOTOMETRIC DATA (SIMULATED):

<p>bridgelux.</p> <p>LED V13 Gen7</p> <p>FWHM 32.0°</p> <p>Efficiency 86 %</p> <p>Peak intensity 2 cd/lm</p> <p>LEDs/each optic 1</p> <p>Light colour White</p> <p>Required components:</p> <p>C13868_LENINA-STD-BASE-VERO13-18</p> <p>C12606_LENINA-DL</p> <p>Bender Wirth: 477 Typ L1</p>	
<p>bridgelux.</p> <p>LED V13 Gen7</p> <p>FWHM 26.0°</p> <p>Efficiency 90 %</p> <p>Peak intensity 2.6 cd/lm</p> <p>LEDs/each optic 1</p> <p>Light colour White</p> <p>Required components:</p> <p>IDEAL: 50-2103CT + 50-2100AN</p>	
<p>bridgelux.</p> <p>LED V22 Gen7</p> <p>FWHM 42.0°</p> <p>Efficiency 90 %</p> <p>Peak intensity 1.5 cd/lm</p> <p>LEDs/each optic 1</p> <p>Light colour White</p> <p>Required components:</p> <p>C13867_LENINA-STD-BASE-VERO29</p> <p>Bender Wirth: 431 Typ L3</p>	
<p>bridgelux.</p> <p>LED V22 Gen7</p> <p>FWHM 42.0°</p> <p>Efficiency 87 %</p> <p>Peak intensity 1.5 cd/lm</p> <p>LEDs/each optic 1</p> <p>Light colour White</p> <p>Required components:</p> <p>C13867_LENINA-STD-BASE-VERO29</p> <p>C12606_LENINA-DL</p> <p>Bender Wirth: 431 Typ L3</p>	

PHOTOMETRIC DATA (SIMULATED):



LED CXA/B 30xx
 FWHM 30.0°
 Efficiency 84 %
 Peak intensity 2 cd/lm
 LEDs/each optic 1
 Light colour White
 Required components:
 C12606_LENINA-DL
 IDEAL: 50-2234C + 50-2100LN

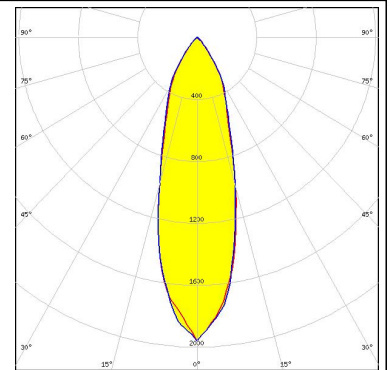

LED CXA/B 30xx
 FWHM 28.0°
 Efficiency 89 %
 Peak intensity 2.4 cd/lm
 LEDs/each optic 1
 Light colour White
 Required components:
 IDEAL: 50-2234C + 50-2100LN

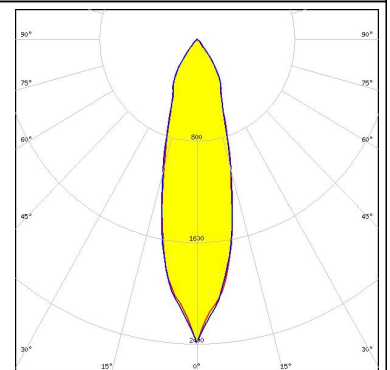

LED CxM-14 (19x19)
 FWHM 31.0°
 Efficiency 88 %
 Peak intensity 2 cd/lm
 LEDs/each optic 1
 Light colour White
 Required components:
 C13868_LENINA-STD-BASE-VERO13-18
 C12606_LENINA-DL
 Bender Wirth: 433 Typ L1



LED CxM-14 (19x19)
 FWHM 29.0°
 Efficiency 91 %
 Peak intensity 2.3 cd/lm
 LEDs/each optic 1
 Light colour White
 Required components:
 C13868_LENINA-STD-BASE-VERO13-18
 Bender Wirth: 433 Typ L1

PHOTOMETRIC DATA (SIMULATED):



LED CxM-9 (13.5x13.5)
FWHM 23.0°
Efficiency 91 %
Peak intensity 3 cd/lm
LEDs/each optic 1
Light colour White
Required components:
 C13868_LENINA-STD-BASE-VERO13-18
 Bender Wirth: 434 Typ L1



LED CxM-9 (13.5x13.5)
FWHM 26.0°
Efficiency 87 %
Peak intensity 2.3 cd/lm
LEDs/each optic 1
Light colour White
Required components:
 C13868_LENINA-STD-BASE-VERO13-18
 C12606_LENINA-DL
 Bender Wirth: 434 Typ L1



Opto Semiconductors

LED Soleriq S15
FWHM 30.0°
Efficiency 90 %
Peak intensity 2.4 cd/lm
LEDs/each optic 1
Light colour White
Required components:
 C12691_LENINA-STD-BASE-CLL030

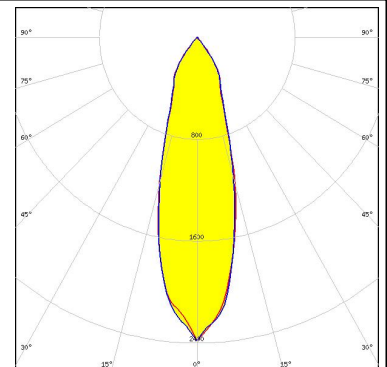



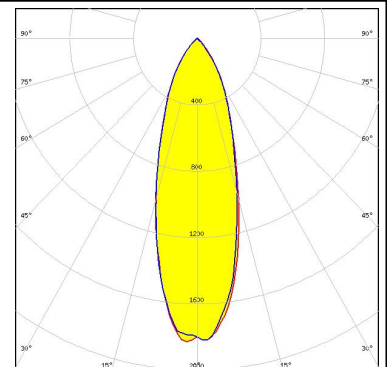

SEOL SEMICONDUCTOR

LED ZC12/18
FWHM 32.0°
Efficiency 84 %
Peak intensity 1.8 cd/lm
LEDs/each optic 1
Light colour White
Required components:
 C12691_LENINA-STD-BASE-CLL030
 C12606_LENINA-DL

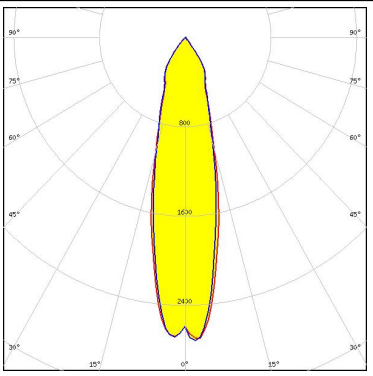

PHOTOMETRIC DATA (SIMULATED):

<p> SEUL SEMICONDUCTOR</p> <p>LED ZC12/18 FWHM 26.0° Efficiency 89 % Peak intensity 2.7 cd/lm LEDs/each optic 1 Light colour White Required components: C12691_LENINA-STD-BASE-CLL030</p>	
<p> SEUL SEMICONDUCTOR</p> <p>LED ZC12/18 FWHM 29.0° Efficiency 91 % Peak intensity 2.3 cd/lm LEDs/each optic 1 Light colour White Required components: C13868_LENINA-STD-BASE-VERO13-18 Bender Wirth: 433 Typ L1</p>	
<p> SEUL SEMICONDUCTOR</p> <p>LED ZC12/18 FWHM 31.0° Efficiency 88 % Peak intensity 2 cd/lm LEDs/each optic 1 Light colour White Required components: C13868_LENINA-STD-BASE-VERO13-18 C12606_LENINA-DL Bender Wirth: 433 Typ L1</p>	
<p> SEUL SEMICONDUCTOR</p> <p>LED ZC4/6 FWHM 23.0° Efficiency 91 % Peak intensity 3 cd/lm LEDs/each optic 1 Light colour White Required components: C13868_LENINA-STD-BASE-VERO13-18 Bender Wirth: 434 Typ L1</p>	

PHOTOMETRIC DATA (SIMULATED):

	
SEOUL SEMICONDUCTOR	
LED	ZC4/6
FWHM	26.0°
Efficiency	87 %
Peak intensity	2.3 cd/lm
LEDs/each optic	1
Light colour	White
Required components:	
C13868_LENINA-STD-BASE-VERO13-18	
C12606_LENINA-DL	
Bender Wirth: 434 Typ L1	

GENERAL INFORMATION:

NOTE: The typical beam angle will be changed by different color, chip size and chip position tolerance. The typical total beam angle is the full angle measured where the luminous intensity is half of the peak value.

Due to use of high power COB's with this product, special attention to proper thermal design is highly recommended. LEDiL has no liability for direct, indirect or consecutive damages arising from the LEDiL products being used outside of the recommended temperature range.

MATERIALS:

As part of our continuous research and improvement processes, and to ensure the best possible quality and availability of our products, LEDiL reserves the right to change material grades without notice.

PRODUCT DATA USER AGREEMENT AND DISCLAIMER:

The measured data in the provided downloadable LEDiL Product Datasheets and Mechanical 2D-Drawings is rounded and provided as reference for planning. LEDiL Oy's optical specifications have been verified by conducting performance testing of the products in accordance with the company's quality system. The reported data are averaged results of multiple measurements with typical variation. LEDiL Oy reserves the right to without prior notification make changes and improvements to its products.

LEDiL Oy assumes neither warranty, nor guarantee nor any other liability of any kind for the contents and correctness of the provided data. The provided data has been generated with highest diligence but the provided data may in reality not represent the complete possible variation range of all intrinsic parameters. Therefore, in certain cases a deviation from the provided data could occur.

LEDiL Oy reserves the right to undertake technical changes of its products without further notification which could lead to changes in the provided data. LEDiL Oy assumes no liability of any kind for the possible deviation from any provided data or any other damage resulting from the usage of the provided data.

The user agrees to this disclaimer and user agreement with the download or usage of the provided files.

LEDiL Oy

Joensuunkatu 13
FI-24240 SALO
Finland

LEDiL Inc.

228 West Page Street
Suite D
Sycamore IL 60178
USA

Local sales and technical support

[www.ledil.com/
where_to_buy](http://www.ledil.com/where_to_buy)

Shipping locations

Salo, Finland
Hong Kong, China

Distribution Partners

[www.ledil.com/
where_to_buy](http://www.ledil.com/where_to_buy)



Компания «ЭлектроПласт» предлагает заключение долгосрочных отношений при поставках импортных электронных компонентов на взаимовыгодных условиях!

Наши преимущества:

- Оперативные поставки широкого спектра электронных компонентов отечественного и импортного производства напрямую от производителей и с крупнейших мировых складов;
- Поставка более 17-ти миллионов наименований электронных компонентов;
- Поставка сложных, дефицитных, либо снятых с производства позиций;
- Оперативные сроки поставки под заказ (от 5 рабочих дней);
- Экспресс доставка в любую точку России;
- Техническая поддержка проекта, помощь в подборе аналогов, поставка прототипов;
- Система менеджмента качества сертифицирована по Международному стандарту ISO 9001;
- Лицензия ФСБ на осуществление работ с использованием сведений, составляющих государственную тайну;
- Поставка специализированных компонентов (Xilinx, Altera, Analog Devices, Intersil, Interpoint, Microsemi, Aeroflex, Peregrine, Syfer, Eurofarad, Texas Instrument, Miteq, Cobham, E2V, MA-COM, Hittite, Mini-Circuits, General Dynamics и др.);

Помимо этого, одним из направлений компании «ЭлектроПласт» является направление «Источники питания». Мы предлагаем Вам помощь Конструкторского отдела:

- Подбор оптимального решения, техническое обоснование при выборе компонента;
- Подбор аналогов;
- Консультации по применению компонента;
- Поставка образцов и прототипов;
- Техническая поддержка проекта;
- Защита от снятия компонента с производства.



Как с нами связаться

Телефон: 8 (812) 309 58 32 (многоканальный)

Факс: 8 (812) 320-02-42

Электронная почта: org@eplast1.ru

Адрес: 198099, г. Санкт-Петербург, ул. Калинина, дом 2, корпус 4, литера А.