

Magnetically Compensated Choke, 1-phase, high design



See below:

Approvals and Compliances

Description

- Current compensated choke
- 1-phase choke
- THT-terminals
- Inductor vertically positioned in housing

Applications

- Attenuation of common mode interferences
- Designed for 230/400 VAC applications
- Chopper amplifiers
- DC drives and stepper motor controls
- Switching power supplies

Weblinks

[pdf data sheet](#), [html datasheet](#), [General Product Information](#), [Approvals](#), [Distributor-Stock-Check](#), [Detailed request for product](#), [SPICE Library](#)

Technical Data

| | | | |
|---------------------------|-----------------------------|---------------------------|--|
| Rated voltage | up to 440 VAC | Test Voltage | 1.8 kV, 50 Hz, 1 min, winding to winding |
| Rated Current | 0.6 - 6.3 A @ Ta 40 °C | Isolation Voltage | 2 kV eff., winding to ambient |
| Rated inductance | 0.6 - 50 mH, Tol. -30% +50% | Climatic Category | 25/100/21 acc. to IEC 60068-1 |
| Power Operating Frequency | 50 - 400 Hz | Allowable Operation Temp. | -25 °C to 100 °C |
| Terminal Type | THT | | |
| Weight | 3 - 30 g | | |
| Material: Housing | UL 94V-0 | | |
| Sealing Compound | UL 94V-0 | | |

Approvals and Compliances

Detailed information on product approvals, code requirements, usage instructions and detailed test conditions can be looked up in [Details about Approvals](#)

SCHURTER products are designed for use in industrial environments. They have approvals from independent testing bodies according to national and international standards. Products with specific characteristics and requirements such as required in the automotive sector according to IATF 16949, medical technology according to ISO 13485 or in the aerospace industry can be offered exclusively with customer-specific, individual agreements by SCHURTER.

Approvals

The approval mark is used by the testing authorities to certify compliance with the safety requirements placed on electronic products.

Approval Reference Type: DFKH

| Approval Logo | Certificates | Certification Body | Description |
|---------------|------------------------------|--------------------|------------------------|
| | UL Approvals | UL | UL File Number: E72928 |





Application standards

Application standards where the product can be used

| Organization | Design | Standard | Description |
|--------------|--------------------------------|----------------|--|
| | Designed for applications acc. | IEC/UL 62368-1 | IEC 62368-1 includes the basic requirements for safety of audio, video, information technology and office equipment. |

Compliances

The product complies with following Guide Lines

| Identification | Details | Initiator | Description |
|--|--|-------------|---|
|  | CE declaration of conformity | SCHURTER AG | The CE marking declares that the product complies with the applicable requirements laid down in the harmonisation of Community legislation on its affixing in accordance with EU Regulation 765/2008. |
|  | RoHS | SCHURTER AG | Directive RoHS 2011/65/EU, Amendment (EU) 2015/863 |
|  | China RoHS | SCHURTER AG | The law SJ / T 11363-2006 (China RoHS) has been in force since 1 March 2007. It is similar to the EU directive RoHS. |
|  | REACH | SCHURTER AG | On 1 June 2007, Regulation (EC) No 1907/2006 on the Registration, Evaluation, Authorization and Restriction of Chemicals 1 (abbreviated as "REACH") entered into force. |

Dimension [mm]

Case 50-2, 51-2, 52-2

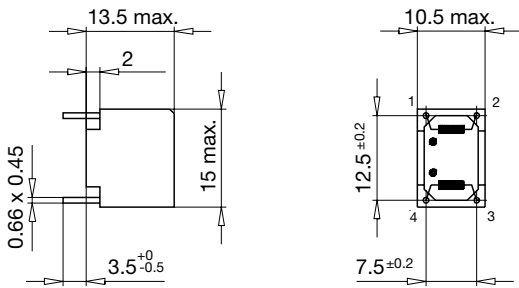

Case 09-2

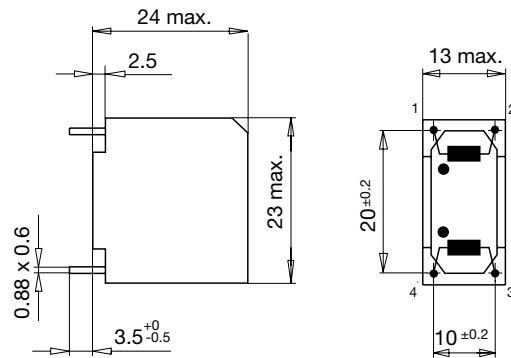

Case 19-2

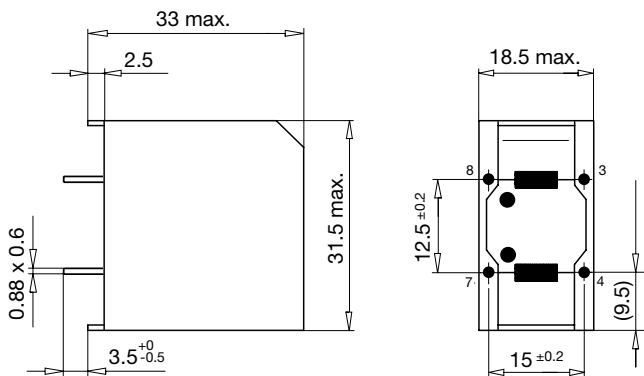

Impedance curves

DFKH-14-xxxx

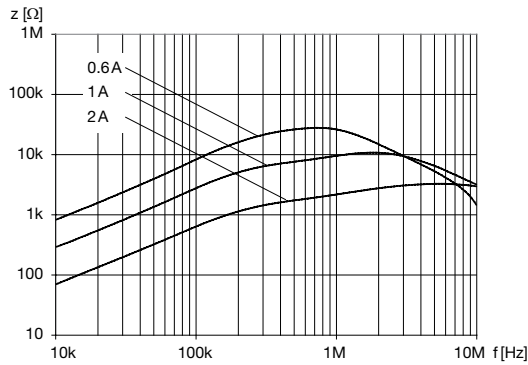

DFKH-22-xxxx

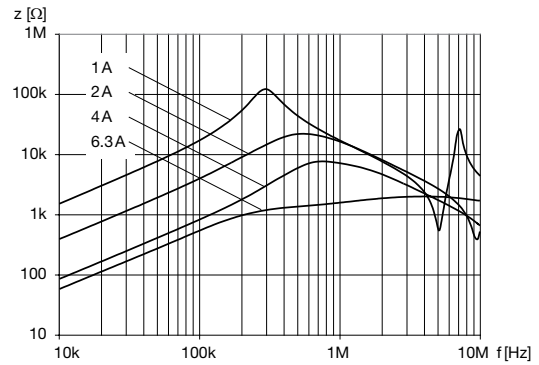

DFKH-31-xxxx

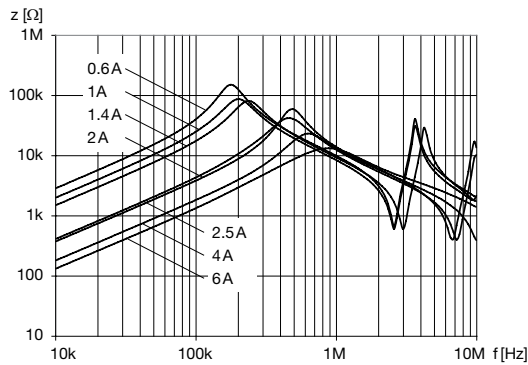

All Variants

| I_n [A] | L_n [mH] | R_{CU} [mΩ] | Tripped Power Dissipation [W] | f_{RES} [MHz] | Weight [g] | Housings | Packing unit [pcs.] | Order Number |
|-----------|------------|---------------|-------------------------------|-----------------|------------|----------|---------------------|--------------|
| 0.6 | 11 | 600 | 0.5 | 0.5 | 3g | 50-2 | 100 | DFKH-14-0001 |
| 0.6 | 50 | 1200 | 0.9 | 0.15 | 22g | 19-2 | 70 | DFKH-31-0001 |
| 1 | 20 | 500 | 1 | 0.25 | 10g | 09-2 | 50 | DFKH-22-0002 |
| 1 | 33 | 700 | 1.4 | 0.25 | 30g | 19-2 | 70 | DFKH-31-0002 |
| 1 | 4 | 250 | 0.5 | 1.2 | 3g | 51-2 | 100 | DFKH-14-0002 |
| 1.4 | 27 | 470 | 1.8 | 0.3 | 30g | 19-2 | 70 | DFKH-31-0003 |
| 2 | 1 | 65 | 0.5 | 2.5 | 3g | 52-2 | 100 | DFKH-14-0003 |
| 2 | 6 | 150 | 1.3 | 0.6 | 10g | 09-2 | 50 | DFKH-22-0003 |
| 2 | 6.8 | 150 | 1.2 | 0.5 | 30g | 19-2 | 70 | DFKH-31-0005 |
| 2.5 | 5.6 | 110 | - | - | 30g | 19-2 | 70 | DFKH-31-0006 |
| 4 | 1.5 | 36 | 1.2 | 1.5 | 10g | 09-2 | 50 | DFKH-22-0004 |
| 4 | 3.3 | 58 | 1.8 | 0.8 | 30g | 19-2 | 70 | DFKH-31-0007 |
| 6 | 2 | 24 | 1.8 | 1.2 | 30g | 19-2 | 70 | DFKH-31-0008 |
| 6.3 | 0.6 | 15 | 1.4 | 2.5 | 10g | 09-2 | 50 | DFKH-22-0005 |

Most Popular.

Availability for all products can be searched real-time: <https://www.schurter.com/en/Stock-Check/Stock-Check-SCHURTER>



Компания «ЭлектроПласт» предлагает заключение долгосрочных отношений при поставках импортных электронных компонентов на взаимовыгодных условиях!

Наши преимущества:

- Оперативные поставки широкого спектра электронных компонентов отечественного и импортного производства напрямую от производителей и с крупнейших мировых складов;
- Поставка более 17-ти миллионов наименований электронных компонентов;
- Поставка сложных, дефицитных, либо снятых с производства позиций;
- Оперативные сроки поставки под заказ (от 5 рабочих дней);
- Экспресс доставка в любую точку России;
- Техническая поддержка проекта, помощь в подборе аналогов, поставка прототипов;
- Система менеджмента качества сертифицирована по Международному стандарту ISO 9001;
- Лицензия ФСБ на осуществление работ с использованием сведений, составляющих государственную тайну;
- Поставка специализированных компонентов (Xilinx, Altera, Analog Devices, Intersil, Interpoint, Microsemi, Aeroflex, Peregrine, Syfer, Eurofarad, Texas Instrument, Miteq, Cobham, E2V, MA-COM, Hittite, Mini-Circuits, General Dynamics и др.);

Помимо этого, одним из направлений компании «ЭлектроПласт» является направление «Источники питания». Мы предлагаем Вам помощь Конструкторского отдела:

- Подбор оптимального решения, техническое обоснование при выборе компонента;
- Подбор аналогов;
- Консультации по применению компонента;
- Поставка образцов и прототипов;
- Техническая поддержка проекта;
- Защита от снятия компонента с производства.



Как с нами связаться

Телефон: 8 (812) 309 58 32 (многоканальный)

Факс: 8 (812) 320-02-42

Электронная почта: org@eplast1.ru

Адрес: 198099, г. Санкт-Петербург, ул. Калинина, дом 2, корпус 4, литера А.