

Negative Output Low Drop Out voltage regulator

■ GENERAL DESCRIPTION

The NJM2828 is a negative output low dropout regulator. Advanced bipolar technology achieves low noise, high precision voltage and high ripple rejection.

It has soft-start and shunt SW function. 1.0 μ F Output capacitor and small package can make NJM2828 suitable for portable items.

■ PACKAGE OUTLINE

SC88A

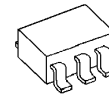

NJM2828F3

■ FEATURES

- Low Current Consumption 0.13V (typ.) @ $I_o=60\text{mA}$
- High Precision Output $\pm 1.5\%$
- High Ripple Rejection 65dB(typ.) @ $f=1\text{kHz}$, $V_o=-7\text{V}$ Version
- Output capacitor with 1.0F ceramic capacitor.
- Output Current $I_o(\text{max.})=100\text{mA}$
- ON/OFF Control(Positive voltage control from 0 to +5V)
- Soft-start Function
- Shunt SW Function
- Internal Thermal Overload Protection
- Internal Short Circuit Current Limit
- Bipolar Technology
- Package Outline SC88A

■ PIN CONFIGURATION

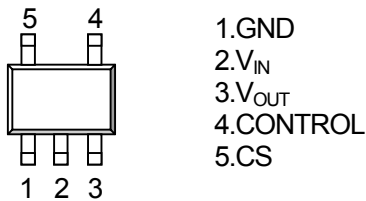

NJM2828F3-XX

■ EQUIVALENT CIRCUIT

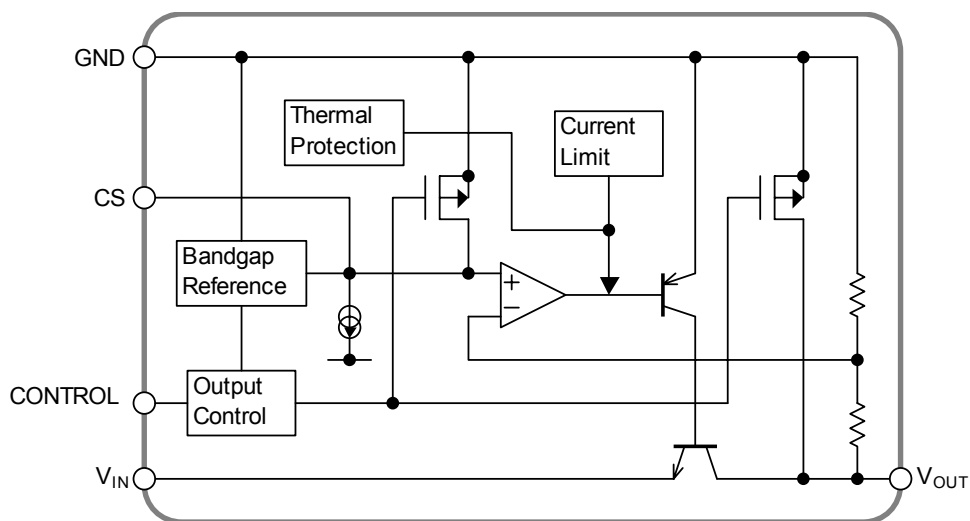

NJM2828

■ OUTPUT VOLTAGE RANK LIST

Device Name	V _{OUT}	Device Name	V _{OUT}
NJM2828F3-14	-1.4V	NJM2828F3-06	-6.0V
NJM2828F3-15	-1.5V	NJM2828F3-63	-6.3V
NJM2828F3-02	-2.0V	NJM2828F3-65	-6.5V
NJM2828F3-22	-2.2V	NJM2828F3-07	-7.0V
NJM2828F3-03	-3.0V	NJM2828F3-75	-7.5V
NJM2828F3-04	-4.0V	NJM2828F3-08	-8.0V
NJM2828F3-05	-5.0V	NJM2828F3-85	-8.5V
NJM2828F3-51	-5.1V	NJM2828F3-09	-9.0V
NJM2828F3-55	-5.5V	NJM2828F3-10	-10.0V

Output voltage options available : -1.5 ~ -10.0V (0.1V step)

■ ABSOLUTE MAXIMUM RATINGS (Ta=25°C)

PARAMETER	SYMBOL	RATINGS	UNIT
Input Voltage	V _{IN}	-14	V
Control Voltage	V _{CONT}	+5	V
Power Dissipation	P _D	250(*1)	mW
Operating Temperature	T _{opr}	-40 ~ +85	°C
Storage Temperature	T _{stg}	-40 ~ +125	°C
Output Sink Current at OFF-state	I _{SINK(OFF)}	10	mA

(*1): Mounted on glass epoxy board. (114.3×76.2×1.6mm : 2layer,FR-4)

■ Operating voltage

V_{IN}=-3.2 ~ -12V (In case of Vo>-3.0V version)

■ ELECTRICAL CHARACTERISTICS

($V_o < -2.2V$ Version: $V_{IN} = V_o - 1V$, $V_{CONT} = 3V$, $C_{IN} = 0.1\mu F$, $C_o = 1.0\mu F$, $T_a = 25^\circ C$)

($V_o \geq -2.2V$ Version: $V_{IN} = -3.2V$, $V_{CONT} = 3V$, $C_{IN} = 0.1\mu F$, $C_o = 2.2\mu F$ ($V_o > -2.0V$: $C_o = 4.7\mu F$), $T_a = 25^\circ C$)

PARAMETER	SYMBOL	TEST CONDITION	MIN.	TYP.	MAX.	UNIT
Output Voltage	V_o	$I_o = 30mA$	+1.5%	-	-1.5%	V
Quiescent Current	I_Q	$I_o = 0mA$, except I_{cont}	-	130	200	μA
Quiescent Current at OFF-state	$I_{Q(OFF)}$	$V_{CONT} = 0V$	-	-	100	nA
Output Current	I_o	$V_o + 0.3V$	100	130	-	mA
Line Regulation	$\Delta V_o / \Delta V_{IN}$	$V_{IN} = V_o - 1V \sim -12V$, $I_o = 30mA$	-	-	0.10	%/V
Load Regulation	$\Delta V_o / \Delta I_o$	$I_o = 0 \sim 60mA$	-	-	0.03	%/mA
Dropout Voltage(*2)	$\Delta V_{I O}$	$I_o = 60mA$	-	0.13	0.23	V
Ripple Rejection	RR	$e_{in} = 200mV_{rms}$, $f = 1kHz$, $I_o = 10mA$ $V_o = -7V$ Version	-	65	-	dB
Average Temperature Coefficient of Output Voltage	$\Delta V_o / \Delta T_a$	$T_a = 0 \sim 85^\circ C$, $I_o = 10mA$	-	± 50	-	ppm/ $^\circ C$
Output Noise Voltage1	V_{NO}	$f = 10Hz \sim 80kHz$, $I_o = 10mA$, $V_o = -7V$ Version	-	100	-	μV_{rms}
CS Terminal Charge Current	I_{cs}	$V_{CS} = 0V$	4	5	6	μA
Output Resistance at OFF-state	$R_{O(OFF)}$	$V_{CONT} = 0V$, $V_o = -7V$ Version	-	360	-	Ω
Control Current	I_{CONT}	$V_{CONT} = 1.6V$	-	2	4	μA
Control Voltage for ON-state	$V_{CONT(ON)}$		1.6	-	-	V
Control Voltage for OFF-state	$V_{CONT(OFF)}$		-	-	0.6	V
Input Voltage	V_{IN}		-12	-	-	V

(*2): Excludes $V_o > -3.0V$ version.

The above specification is a common specification for all output voltages.

Therefore, it may be different from the individual specification for a specific output voltage.

NJM2828

TEST CIRCUIT

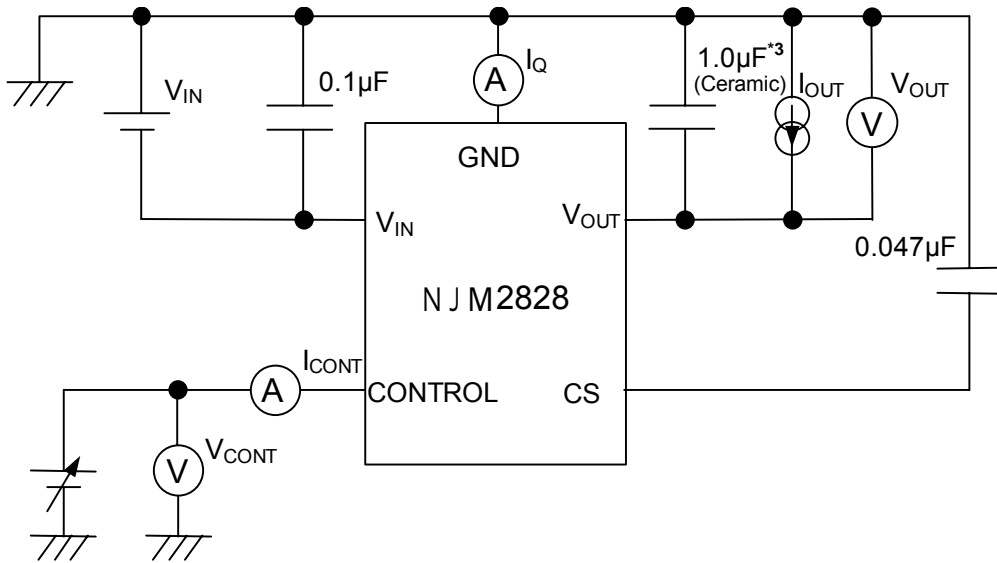

*3 $-2.2V \leq V_o < -2.0V$ version : $C_o = 2.2\mu F$ (Ceramic)
 $V_o \geq -2.0V$ version : $C_o = 4.7\mu F$ (Ceramic)

■ TYPICAL APPLICATIONS

*ON/OFF control

ON/OFF control can be achieved by applying positive control voltage to CONTROL terminal.

Apply positive V_{cont} ("H") to make chip to be ON (Enabled), and either V_{cont} is "L" or open (High Z) to make chip to be OFF (Disabled).

The relations between V_{cont} and the state is as follows:

$V_{cont} + 1.6V \leq V_{cont} \leq +5V$ ("H" level):	ON state
$V_{cont} 0V \leq V_{cont} \leq +0.6V$ ("L" level):	OFF state
$V_{cont} + 0.6V < V_{cont} < +1.6V$ ("L" level):	Undefined

In case ON/OFF control is not used, keep applying positive V_{cont} to CONTROL terminal to make chip ON.

Note that negative V_{cont} does not make the chip enabled.

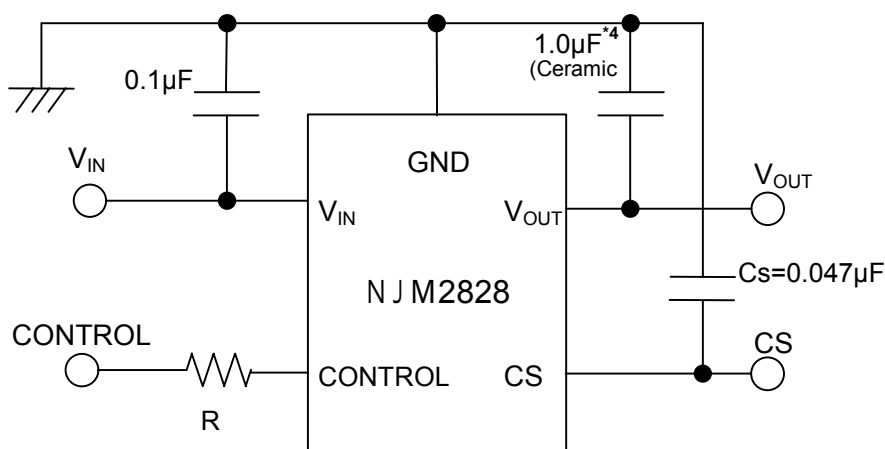

*4 $-2.2V \leq V_o < -2.0V$ version : $C_o = 2.2\mu F$
 $V_o \geq -2.0V$ version : $C_o = 4.7\mu F$

*In the case of using a resistance "R" between V_{IN} and control.

If this resistor is inserted, it can reduce the control current when the control voltage is high.

The applied voltage to control terminal should set to consider voltage drop through the resistor "R" and the minimum control voltage for ON-state.

The $V_{CONT(ON)}$ and I_{CONT} have temperature dependence as shown in the "Control Current vs. Temperature" and "Control Voltage vs. Temperature" characteristics. Therefore, the resistance "R" should be selected to consider the temperature characteristics.

*Input Capacitance C_{IN}

Input Capacitor C_{IN} is required to prevent oscillation and reduce power supply ripple for applications when high power supply impedance or a long power supply line.

Therefore, use the recommended C_{IN} value (refer to conditions of ELECTRIC CHARACTERISTIC) or larger and should connect between GND and V_{IN} as shortest path as possible to avoid the problem.

*Output Capacitance C_O

Output capacitor (C_O) will be required for a phase compensation of the internal error amplifier.

The capacitance and the equivalent series resistance (ESR) influence to stable operation of the regulator.

Use of a smaller C_O may cause excess output noise or oscillation of the regulator due to lack of the phase compensation.

On the other hand, Use of a larger C_O reduces output noise and ripple output, and also improves output transient response when rapid load change.

Therefore, use the recommended C_O value (refer to conditions of ELECTRIC CHARACTERISTIC) or larger and should connect between GND and V_{OUT} as shortest path as possible for stable operation

The recommended capacitance depends on the output voltage rank. Especially, low voltage regulator requires larger C_O value.

In addition, you should consider varied characteristics of capacitor (a frequency characteristic, a temperature characteristic, a DC bias characteristic and so on) and unevenness peculiar to a capacitor supplier enough.

When selecting C_O , recommend that have withstand voltage margin against output voltage and superior temperature characteristic.

*Soft-start function

Capacitance C_s connect between CS pin and GND for the following.

- Control at risetime of output voltage.
- Reduces inrush current at output ON.

When the soft start function is not used, CS pin should be open.

1. C_s capacitance vs risetime of output voltage

Calculation : risetime of output voltage Δt (ms) $\cong 213 \times C_s$ (μF)

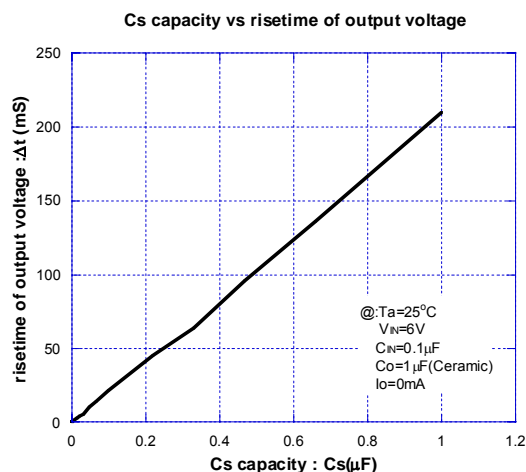

2. Inrush current at control ON

The peak value of the inrush current can be limited according to the capacitance of the C_s .

Inrush current wave :

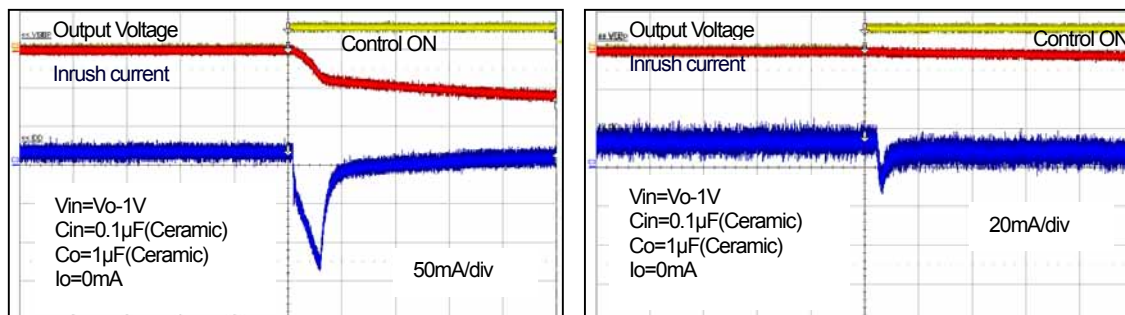

* This characteristic is one example. It is necessary to examine the characteristic with an actual circuit because there is an influence by the characteristic such as output voltage/output capacitor.

NJM2828

POWER DISSIPATION vs. AMBIENT TEMPERATURE

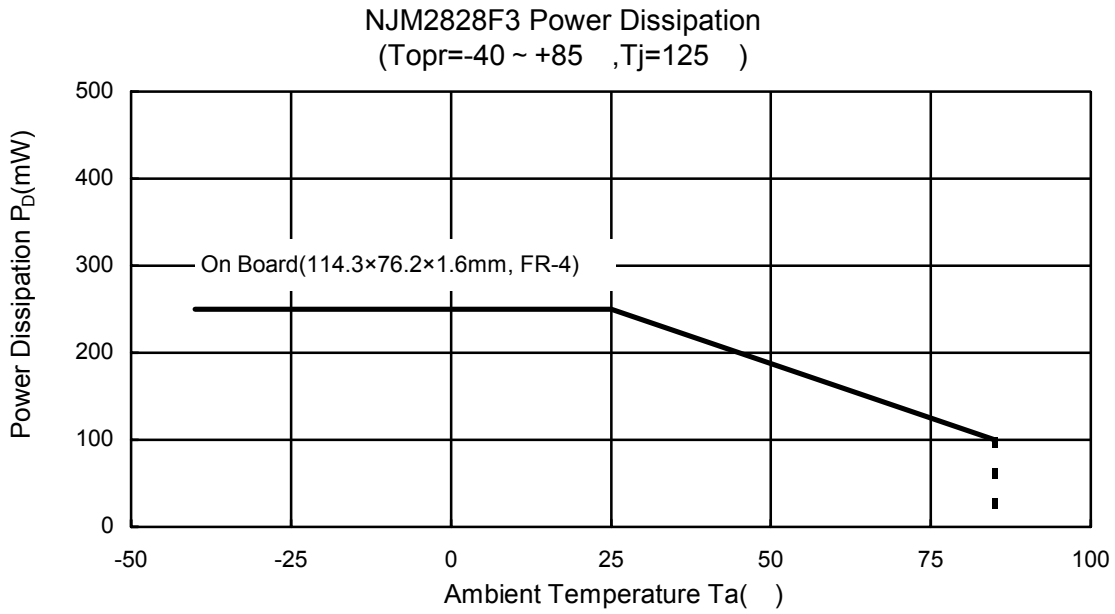

ELECTRICAL CHARACTERISTICS

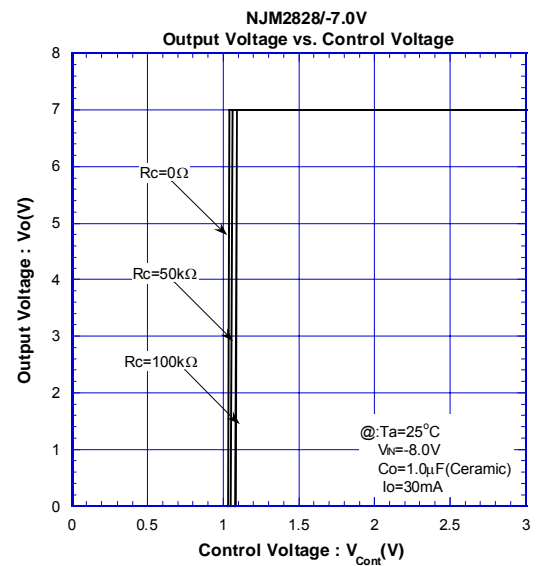
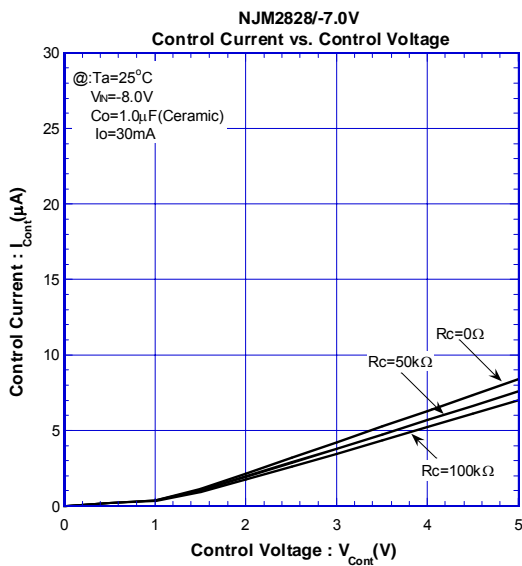
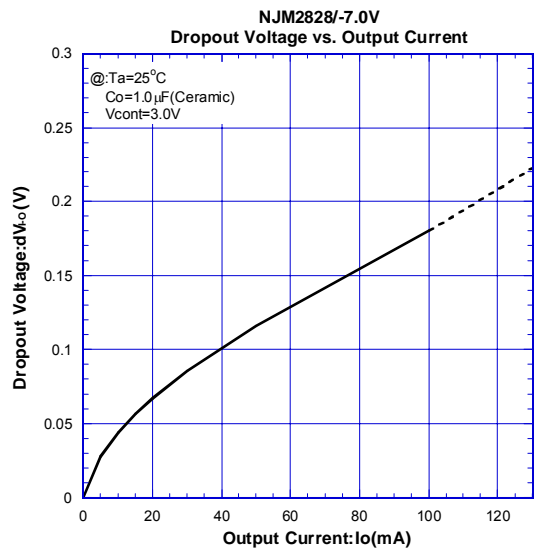
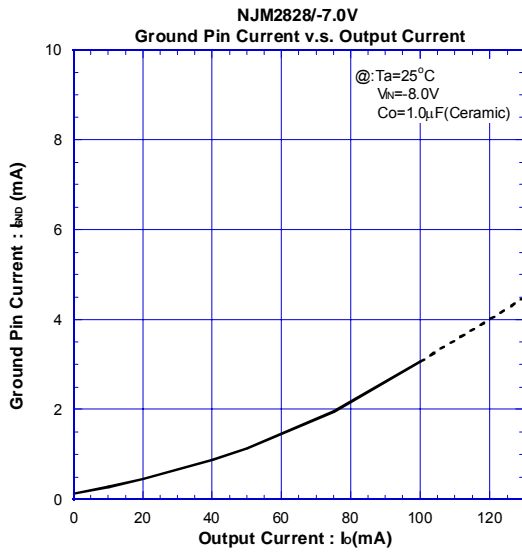
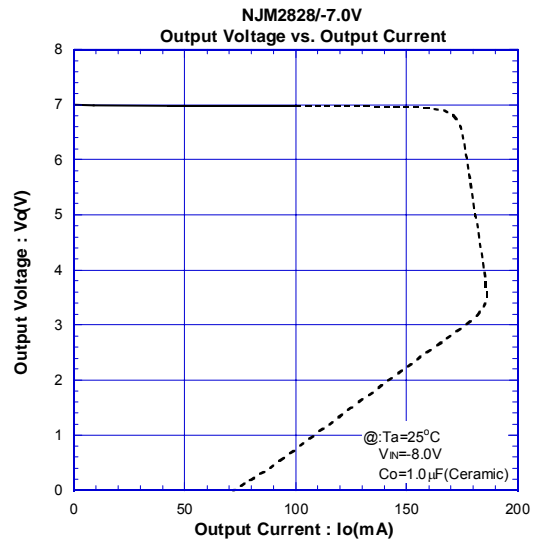
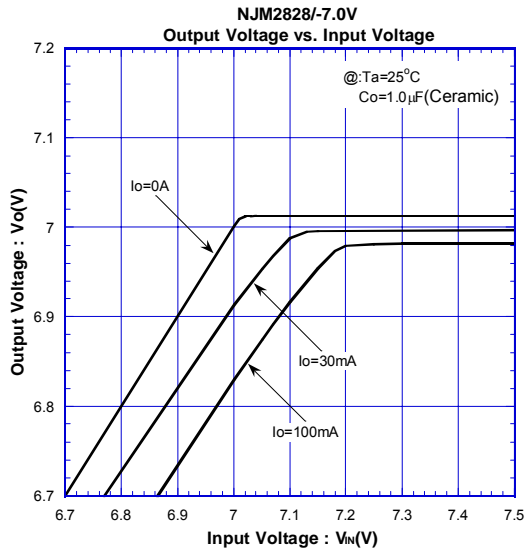

NJM2828

ELECTRICAL CHARACTERISTICS

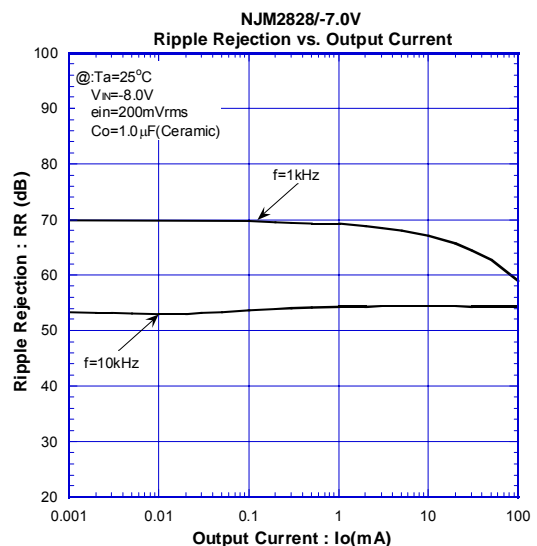
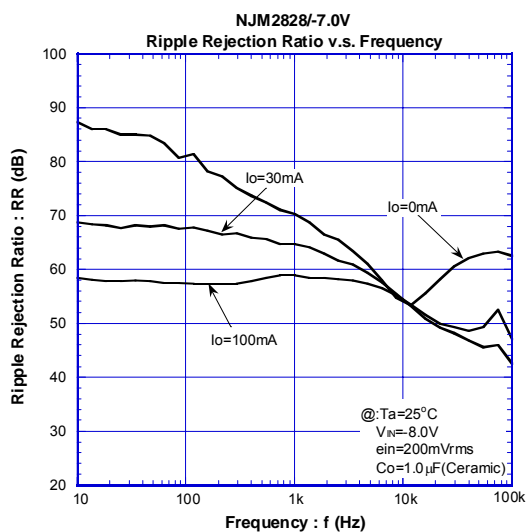
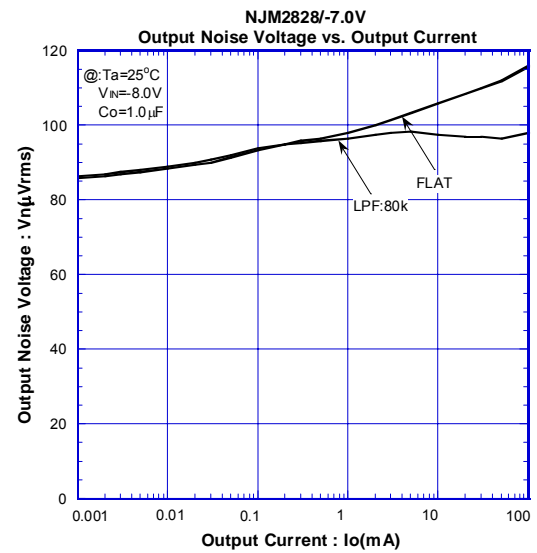
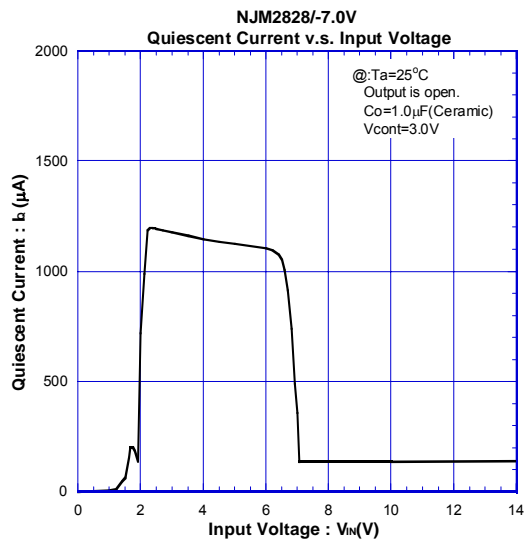
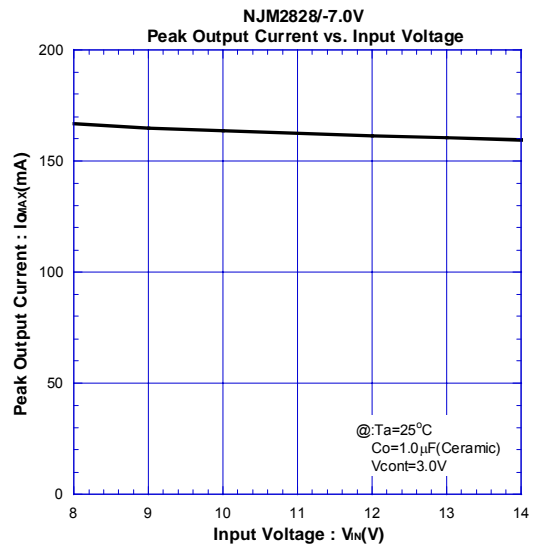
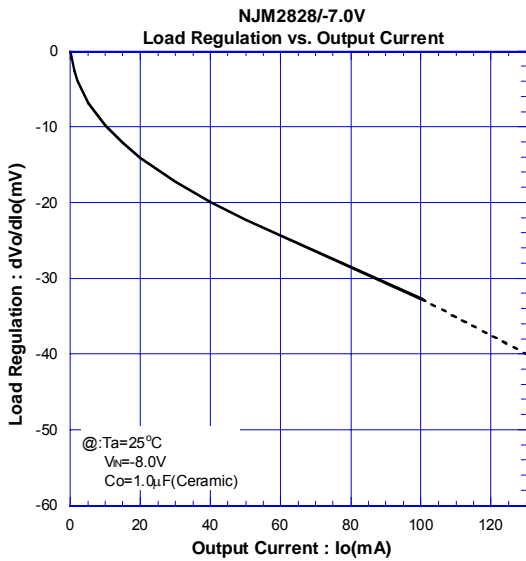

ELECTRICAL CHARACTERISTICS

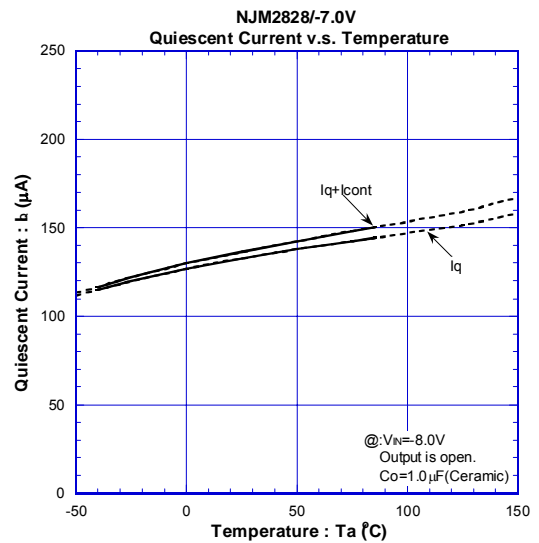
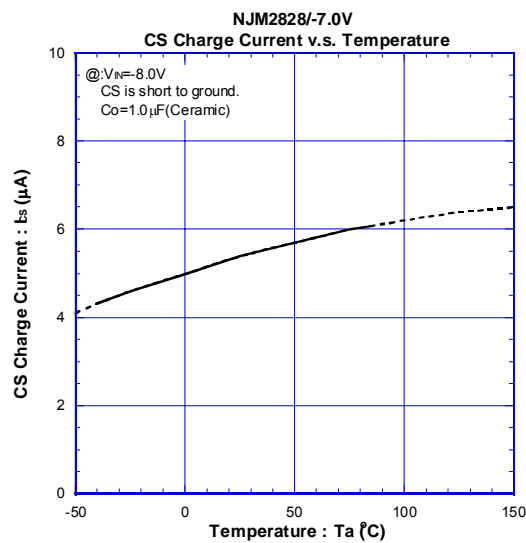
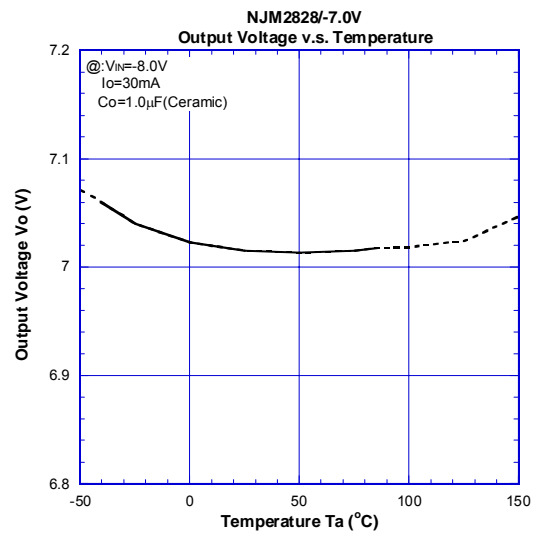
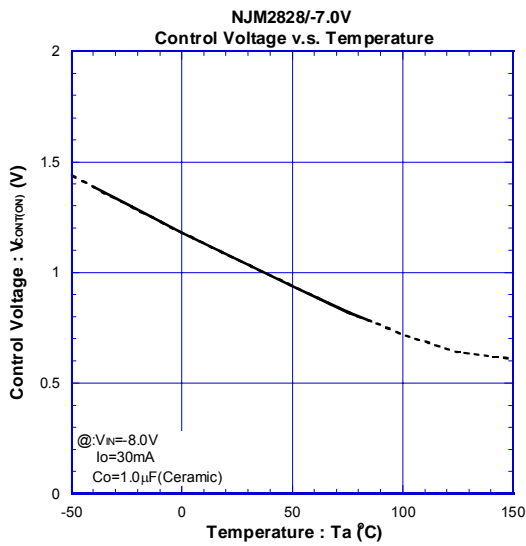
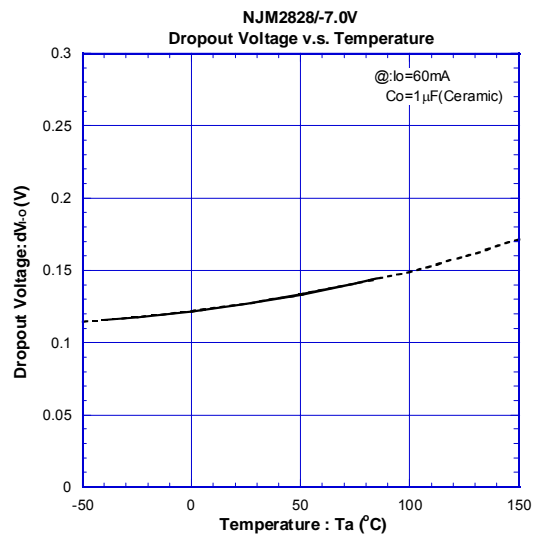
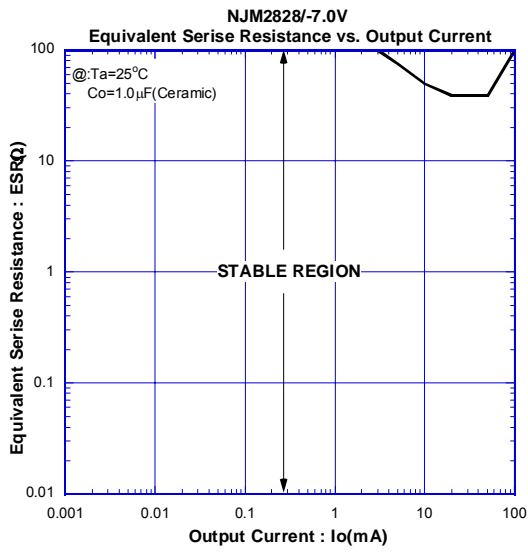

ELECTRICAL CHARACTERISTICS

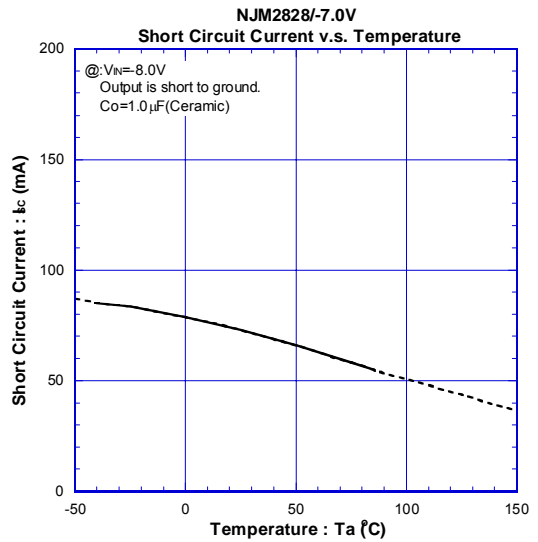
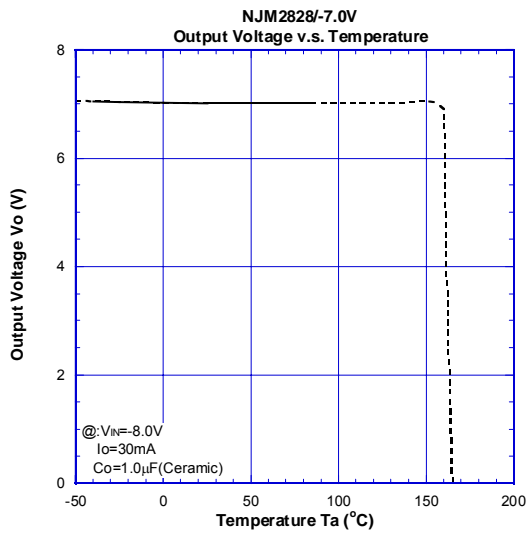
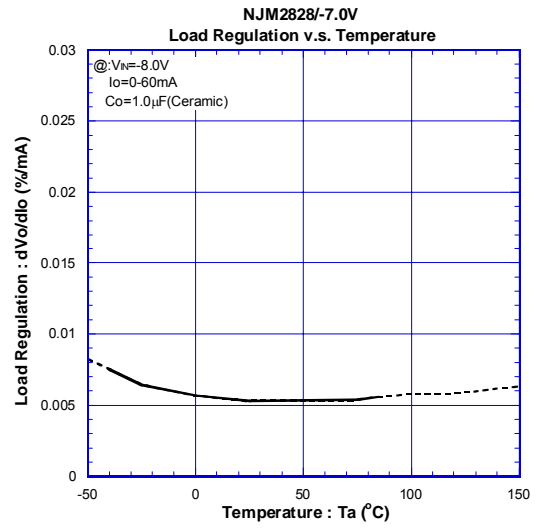
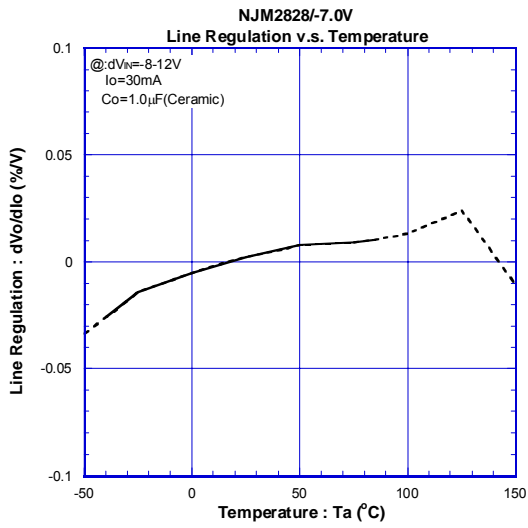

ELECTRICAL CHARACTERISTICS

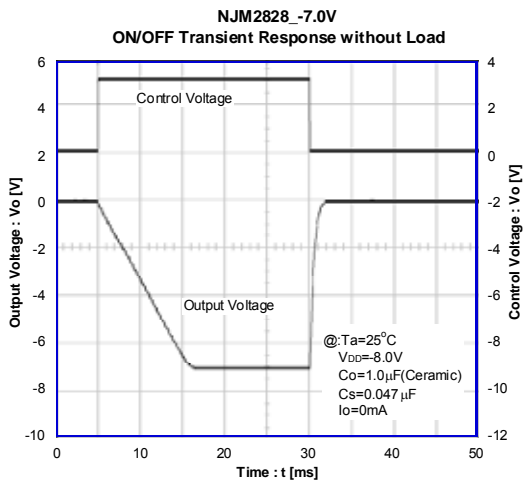
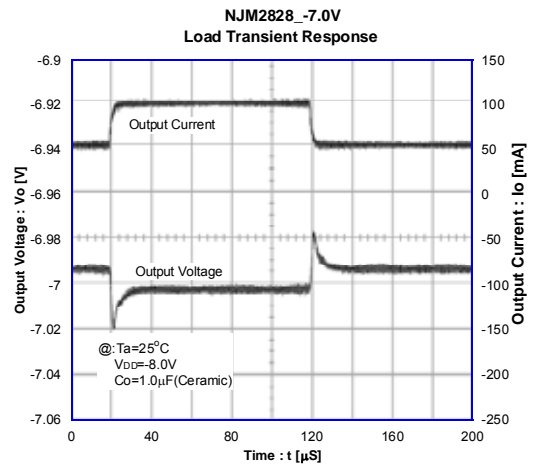
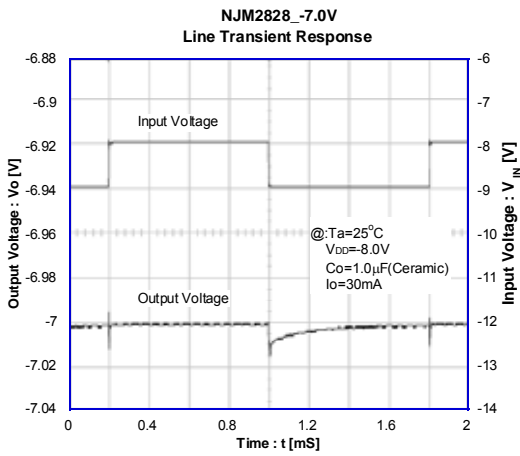

[CAUTION]

The specifications on this databook are only given for information, without any guarantee as regards either mistakes or omissions. The application circuits in this databook are described only to show representative usages of the product and not intended for the guarantee or permission of any right including the industrial rights.

Mouser Electronics

Authorized Distributor

Click to View Pricing, Inventory, Delivery & Lifecycle Information:

[NJR:](#)

[NJM2828F3-75-TE1](#) [NJM2828F3-05-TE1](#) [NJM2828F3-08-TE1](#) [NJM2828F3-06-TE1](#) [NJM2828F3-04-TE1](#)
[NJM2828F3-15-TE1](#) [NJM2828F3-03-TE1](#) [NJM2828F3-07-TE1](#)



Компания «ЭлектроПласт» предлагает заключение долгосрочных отношений при поставках импортных электронных компонентов на взаимовыгодных условиях!

Наши преимущества:

- Оперативные поставки широкого спектра электронных компонентов отечественного и импортного производства напрямую от производителей и с крупнейших мировых складов;
- Поставка более 17-ти миллионов наименований электронных компонентов;
- Поставка сложных, дефицитных, либо снятых с производства позиций;
- Оперативные сроки поставки под заказ (от 5 рабочих дней);
- Экспресс доставка в любую точку России;
- Техническая поддержка проекта, помощь в подборе аналогов, поставка прототипов;
- Система менеджмента качества сертифицирована по Международному стандарту ISO 9001;
- Лицензия ФСБ на осуществление работ с использованием сведений, составляющих государственную тайну;
- Поставка специализированных компонентов (Xilinx, Altera, Analog Devices, Intersil, Interpoint, Microsemi, Aeroflex, Peregrine, Syfer, Eurofarad, Texas Instrument, Miteq, Cobham, E2V, MA-COM, Hittite, Mini-Circuits, General Dynamics и др.);

Помимо этого, одним из направлений компании «ЭлектроПласт» является направление «Источники питания». Мы предлагаем Вам помощь Конструкторского отдела:

- Подбор оптимального решения, техническое обоснование при выборе компонента;
- Подбор аналогов;
- Консультации по применению компонента;
- Поставка образцов и прототипов;
- Техническая поддержка проекта;
- Защита от снятия компонента с производства.



Как с нами связаться

Телефон: 8 (812) 309 58 32 (многоканальный)

Факс: 8 (812) 320-02-42

Электронная почта: org@eplast1.ru

Адрес: 198099, г. Санкт-Петербург, ул. Калинина, дом 2, корпус 4, литера А.