

BAV23 series

Dual high-voltage switching diodes

Rev. 07 — 19 March 2010

Product data sheet

1. Product profile

1.1 General description

Dual high-voltage switching diodes, encapsulated in small Surface-Mounted Device (SMD) plastic packages.

Table 1. Product overview

Type number	Package		Configuration
	Nexperia	JEDEC	
BAV23A	SOT23	TO-236AB	dual common anode
BAV23C	SOT23	TO-236AB	dual common cathode
BAV23S	SOT23	TO-236AB	dual series
BAV23	SOT143B	-	dual isolated

1.2 Features and benefits

- High switching speed: $t_{rr} \leq 50$ ns
- Low leakage current
- Repetitive peak reverse voltage: $V_{RRM} \leq 250$ V
- Low capacitance: $C_d \leq 2$ pF
- Small SMD plastic package

1.3 Applications

- High-speed switching at high voltage
- High-voltage general-purpose switching

1.4 Quick reference data

Table 2. Quick reference data

Symbol	Parameter	Conditions	Min	Typ	Max	Unit
Per diode						
I_R	reverse current	$V_R = 200$ V	-	-	100	nA
V_R	reverse voltage		-	-	200	V
t_{rr}	reverse recovery time		[1]	-	50	ns

[1] When switched from $I_F = 10$ mA to $I_R = 10$ mA; $R_L = 100$ Ω ; measured at $I_R = 1$ mA.

2. Pinning information

Table 3. Pinning

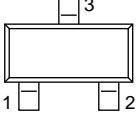
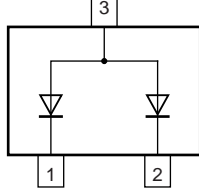
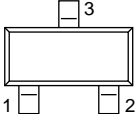
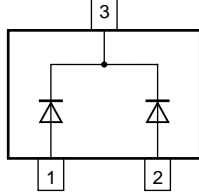
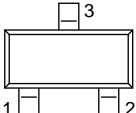
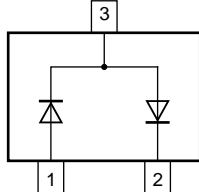
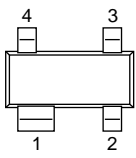
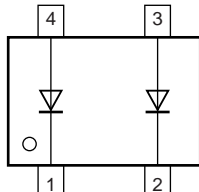
Pin	Description	Simplified outline	Graphic symbol
BAV23A			
1	cathode (diode 1)		 <p>006aab099</p>
2	cathode (diode 2)		
3	common anode		
BAV23C			
1	anode (diode 1)		 <p>006aab034</p>
2	anode (diode 2)		
3	common cathode		
BAV23S			
1	anode (diode 1)		 <p>006aaa763</p>
2	cathode (diode 2)		
3	cathode (diode 1), anode (diode 2)		
BAV23			
1	cathode (diode 1)		 <p>006aab100</p>
2	cathode (diode 2)		
3	anode (diode 2)		
4	anode (diode 1)		

3. Ordering information

Table 4. Ordering information

Type number	Package		
	Name	Description	Version
BAV23A	-	plastic surface-mounted package; 3 leads	SOT23
BAV23C			
BAV23S			
BAV23	-	plastic surface-mounted package; 4 leads	SOT143B

4. Marking

Table 5. Marking codes

Type number	Marking code ^[1]
BAV23A	*V0
BAV23C	*V9
BAV23S	*V5
BAV23	*L3

- [1] * = -: made in Hong Kong
 * = p: made in Hong Kong
 * = t: made in Malaysia
 * = W: made in China

5. Limiting values

Table 6. Limiting values

In accordance with the Absolute Maximum Rating System (IEC 60134).

Symbol	Parameter	Conditions	Min	Max	Unit
Per diode					
V_{RRM}	repetitive peak reverse voltage		-	250	V
V_R	reverse voltage		-	200	V
I_F	forward current		[1] -	225	mA
			[2] -	125	mA
I_{FRM}	repetitive peak forward current		-	625	mA
I_{FSM}	non-repetitive peak forward current	square wave	[3]		
		$t_p = 1 \mu\text{s}$	-	9	A
		$t_p = 100 \mu\text{s}$	-	3	A
		$t_p = 10 \text{ms}$	-	1.7	A

Table 6. Limiting values ...continued*In accordance with the Absolute Maximum Rating System (IEC 60134).*

Symbol	Parameter	Conditions	Min	Max	Unit
Per device					
P_{tot}	total power dissipation	$T_{\text{amb}} \leq 25 \text{ }^\circ\text{C}$	[4] -	250	mW
T_{j}	junction temperature		-	150	$^\circ\text{C}$
T_{amb}	ambient temperature		-65	+150	$^\circ\text{C}$
T_{stg}	storage temperature		-65	+150	$^\circ\text{C}$

[1] Single diode loaded.

[2] Double diode loaded.

[3] $T_{\text{j}} = 25 \text{ }^\circ\text{C}$ prior to surge.

[4] Device mounted on an FR4 Printed-Circuit Board (PCB), single-sided copper, tin-plated and standard footprint.

6. Thermal characteristics

Table 7. Thermal characteristics

Symbol	Parameter	Conditions	Min	Typ	Max	Unit
Per device						
$R_{\text{th(j-a)}}$	thermal resistance from junction to ambient	in free air	[1] -	-	500	K/W
$R_{\text{th(j-sp)}}$	thermal resistance from junction to solder point		-	-	360	K/W

[1] Device mounted on an FR4 PCB, single-sided copper, tin-plated and standard footprint.

7. Characteristics

Table 8. Characteristics *$T_{\text{amb}} = 25 \text{ }^\circ\text{C}$ unless otherwise specified.*

Symbol	Parameter	Conditions	Min	Typ	Max	Unit
Per diode						
V_{F}	forward voltage	$I_{\text{F}} = 100 \text{ mA}$	-	-	1.0	V
		$I_{\text{F}} = 200 \text{ mA}$	-	-	1.25	V
I_{R}	reverse current	$V_{\text{R}} = 200 \text{ V}$	-	-	100	nA
		$V_{\text{R}} = 200 \text{ V}; T_{\text{j}} = 150 \text{ }^\circ\text{C}$	-	-	100	μA
C_{d}	diode capacitance	$f = 1 \text{ MHz}; V_{\text{R}} = 0 \text{ V}$	-	-	2	pF
t_{rr}	reverse recovery time		[1] -	-	50	ns

[1] When switched from $I_{\text{F}} = 10 \text{ mA}$ to $I_{\text{R}} = 10 \text{ mA}$; $R_{\text{L}} = 100 \text{ } \Omega$; measured at $I_{\text{R}} = 1 \text{ mA}$.

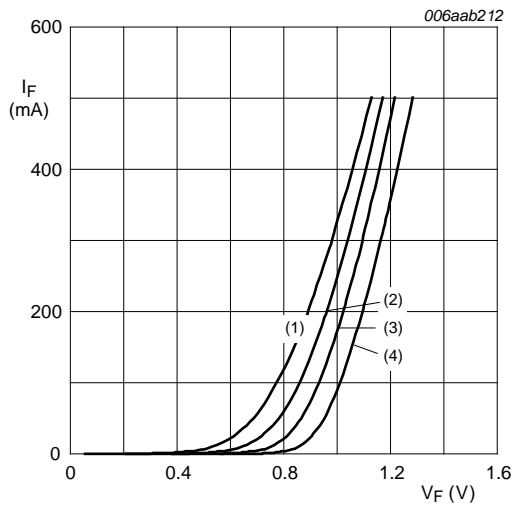

- (1) $T_{amb} = 150\text{ °C}$
- (2) $T_{amb} = 85\text{ °C}$
- (3) $T_{amb} = 25\text{ °C}$
- (4) $T_{amb} = -40\text{ °C}$

Fig 1. Forward current as a function of forward voltage; typical values

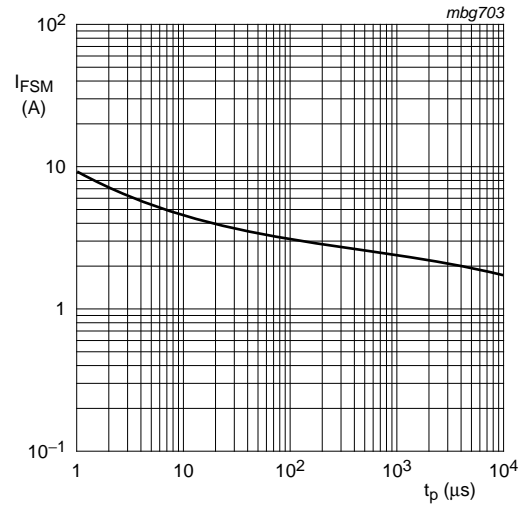

Based on square wave currents.
 $T_j = 25\text{ °C}$; prior to surge

Fig 2. Non-repetitive peak forward current as a function of pulse duration; maximum values

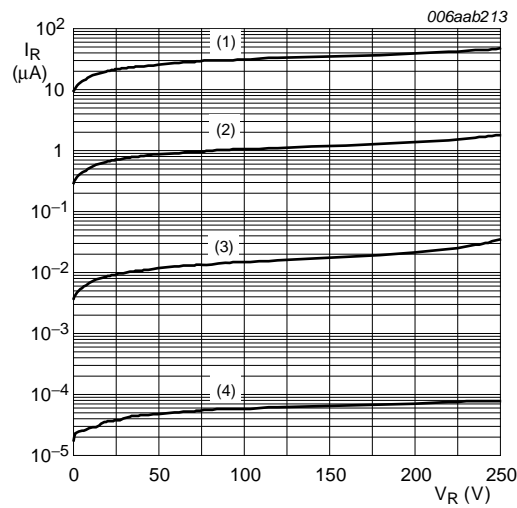

- (1) $T_{amb} = 150\text{ °C}$
- (2) $T_{amb} = 85\text{ °C}$
- (3) $T_{amb} = 25\text{ °C}$
- (4) $T_{amb} = -40\text{ °C}$

Fig 3. Reverse current as a function of reverse voltage; typical values

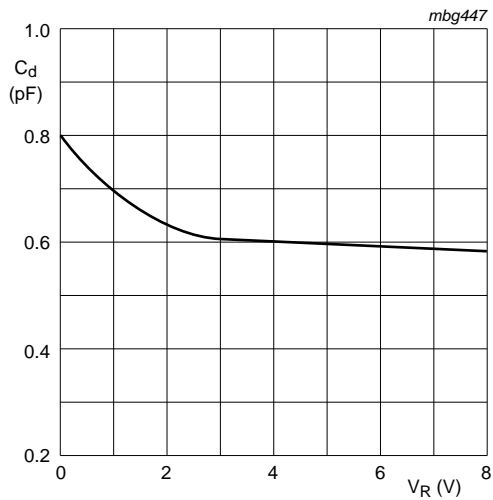

f = 1 MHz; T_{amb} = 25 °C

Fig 4. Diode capacitance as a function of reverse voltage; typical values

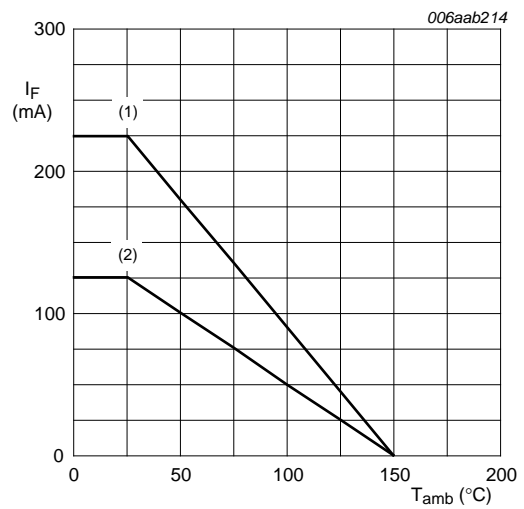

FR4 PCB, standard footprint

- (1) Single diode loaded.
- (2) Double diode loaded.

Fig 5. Forward current as a function of ambient temperature; derating curves

8. Test information

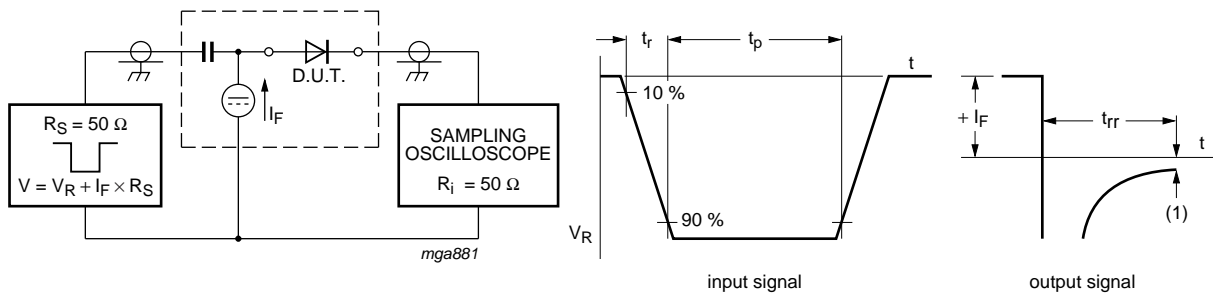

(1) I_R = 1 mA

Fig 6. Reverse recovery time test circuit and waveforms

9. Package outline

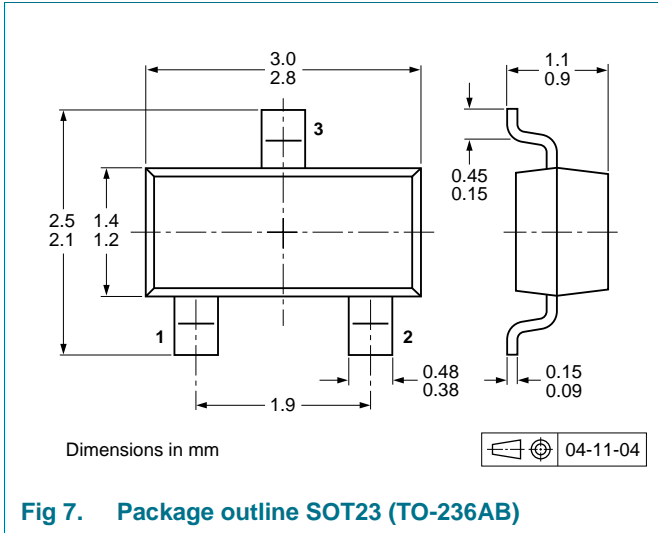

Fig 7. Package outline SOT23 (TO-236AB)

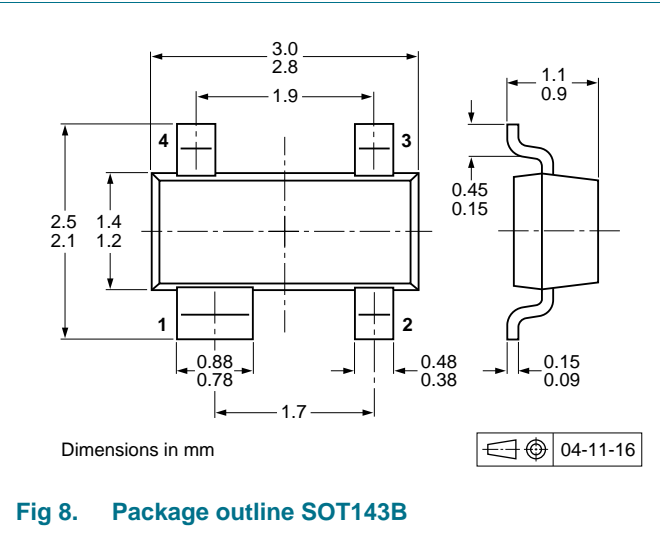

Fig 8. Package outline SOT143B

10. Packing information

Table 9. Packing methods

The indicated -xxx are the last three digits of the 12NC ordering code.^[1]

Type number	Package	Description	Packing quantity	
			3000	10000
BAV23A	SOT23	4 mm pitch, 8 mm tape and reel	-215	-235
BAV23C				
BAV23S				
BAV23	SOT143B	4 mm pitch, 8 mm tape and reel	-215	-235

[1] For further information and the availability of packing methods, see [Section 14](#).

11. Soldering

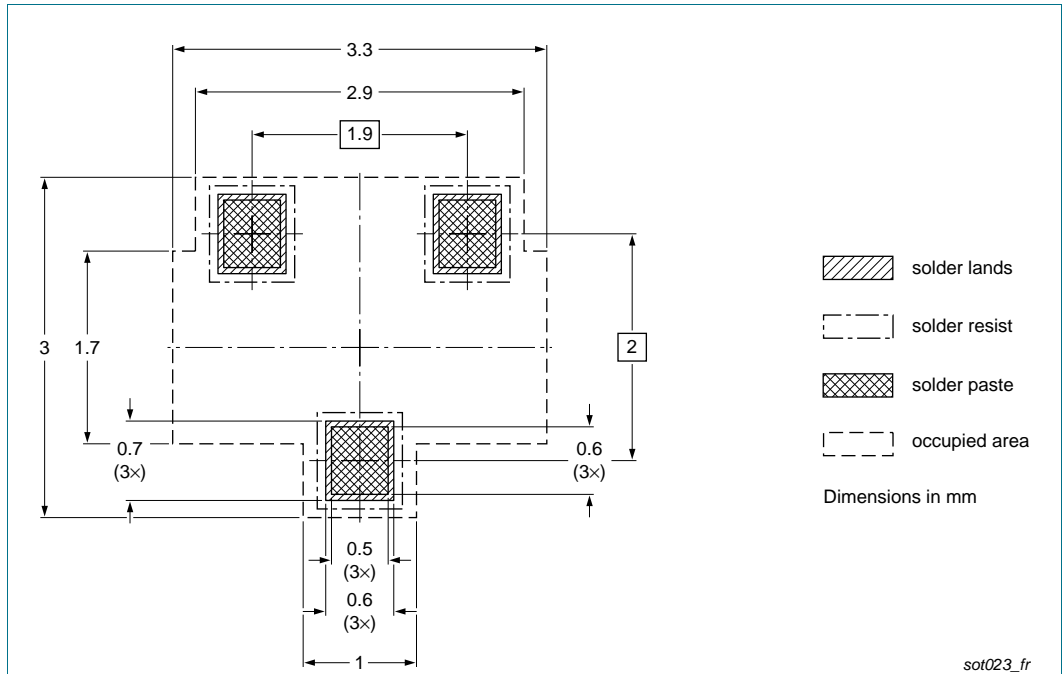

Fig 9. Reflow soldering footprint SOT23 (TO-236AB)

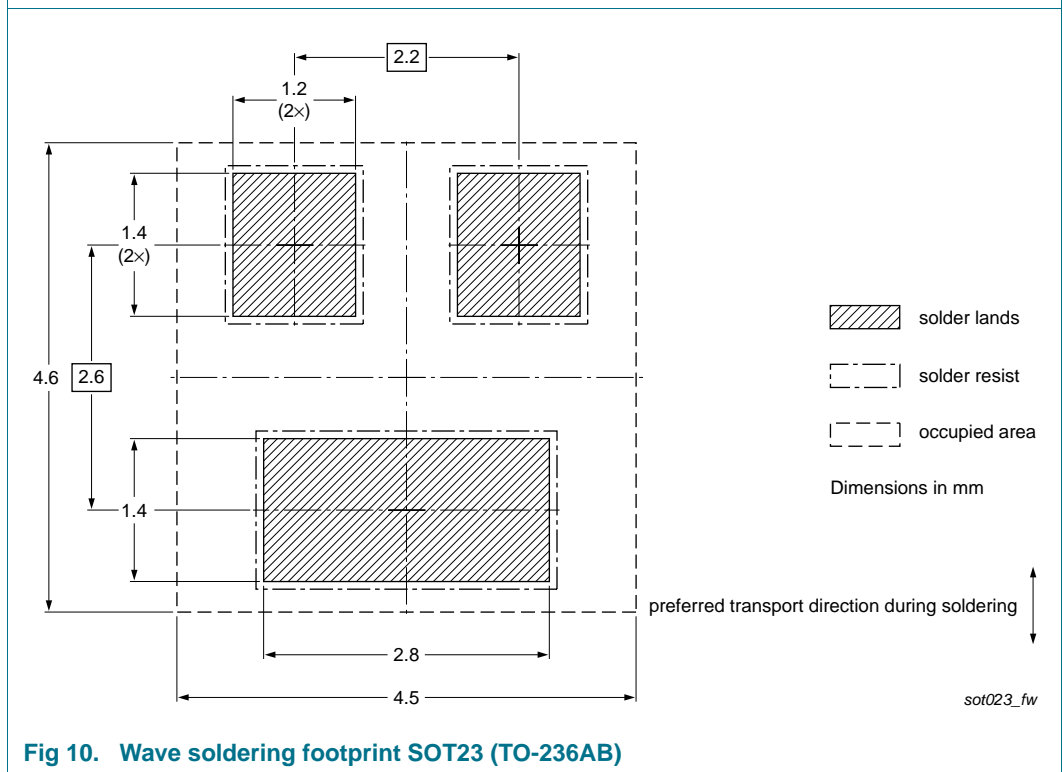

Fig 10. Wave soldering footprint SOT23 (TO-236AB)

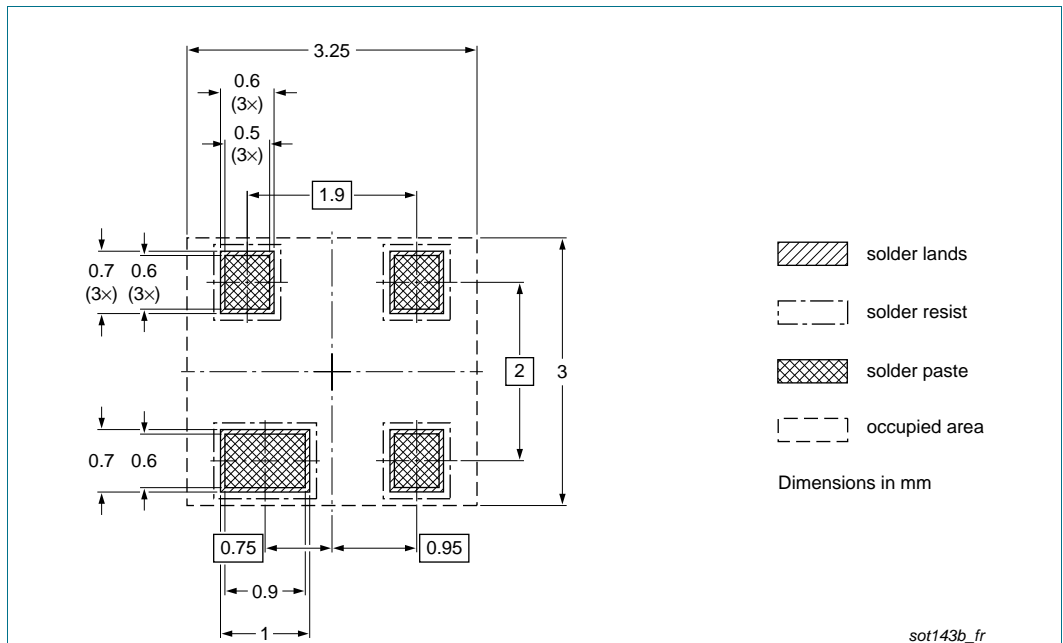

Fig 11. Reflow soldering footprint SOT143B

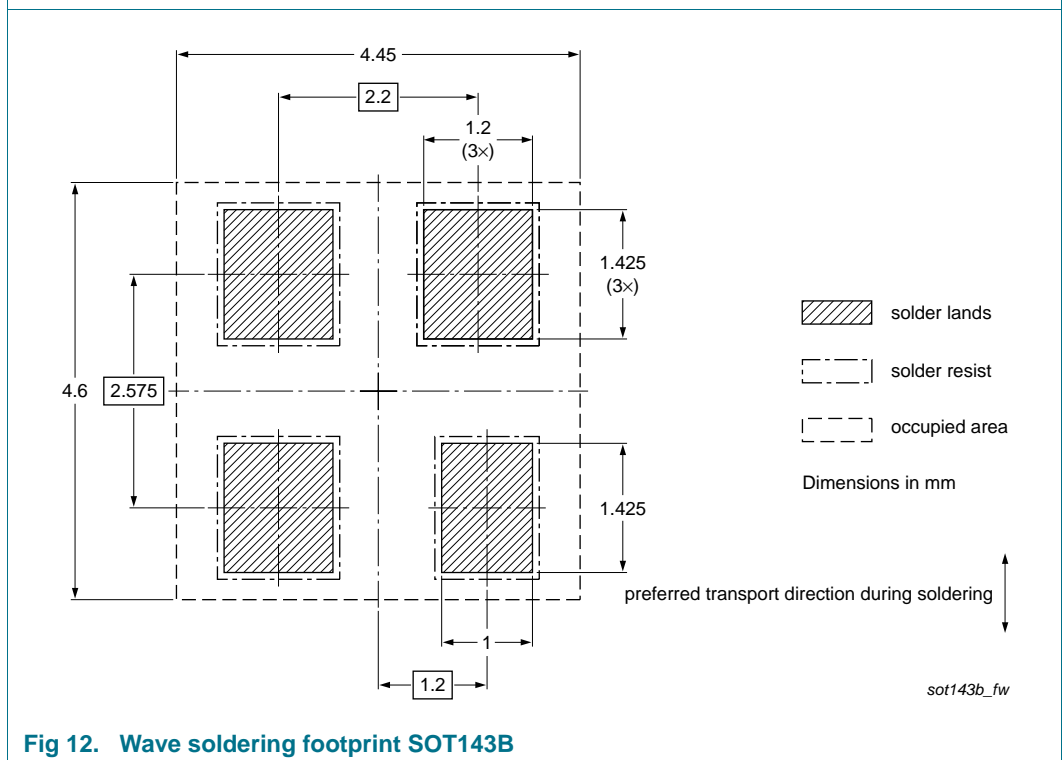

Fig 12. Wave soldering footprint SOT143B

12. Revision history

Table 10. Revision history

Document ID	Release date	Data sheet status	Change notice	Supersedes
BAV23_SER_7	20100319	Product data sheet	-	BAV23_SER_6
Modifications:	<ul style="list-style-type: none"> • Type numbers BAV23A/DG, BAV23C/DG, BAV23S/DG and BAV23/DG deleted • Type numbers BAV23A and BAV23C added • Table 5 “Marking codes”: updated • Figure 6: adaptation of test condition to specified characteristics in Table 8 • Figure 9, 10, 11 and 12: updated • Section 13 “Legal information”: updated 			
BAV23_SER_6	20080303	Product data sheet	-	BAV23S_5 BAV23_2
BAV23S_5	20011012	Product specification	-	BAV23S_4
BAV23_2	19960917	Product specification	-	BAV23_1

13. Legal information

13.1 Data sheet status

Document status ^{[1][2]}	Product status ^[3]	Definition
Objective [short] data sheet	Development	This document contains data from the objective specification for product development.
Preliminary [short] data sheet	Qualification	This document contains data from the preliminary specification.
Product [short] data sheet	Production	This document contains the product specification.

[1] Please consult the most recently issued document before initiating or completing a design.

[2] The term 'short data sheet' is explained in section "Definitions".

[3] The product status of device(s) described in this document may have changed since this document was published and may differ in case of multiple devices. The latest product status information is available on the Internet at URL <http://www.nexperia.com>.

13.2 Definitions

Draft — The document is a draft version only. The content is still under internal review and subject to formal approval, which may result in modifications or additions. Nexperia does not give any representations or warranties as to the accuracy or completeness of information included herein and shall have no liability for the consequences of use of such information.

Short data sheet — A short data sheet is an extract from a full data sheet with the same product type number(s) and title. A short data sheet is intended for quick reference only and should not be relied upon to contain detailed and full information. For detailed and full information see the relevant full data sheet, which is available on request via the local Nexperia sales office. In case of any inconsistency or conflict with the short data sheet, the full data sheet shall prevail.

Product specification — The information and data provided in a Product data sheet shall define the specification of the product as agreed between Nexperia and its customer, unless Nexperia and customer have explicitly agreed otherwise in writing. In no event however, shall an agreement be valid in which the Nexperia product is deemed to offer functions and qualities beyond those described in the Product data sheet.

13.3 Disclaimers

Limited warranty and liability — Information in this document is believed to be accurate and reliable. However, Nexperia does not give any representations or warranties, expressed or implied, as to the accuracy or completeness of such information and shall have no liability for the consequences of use of such information.

In no event shall Nexperia be liable for any indirect, incidental, punitive, special or consequential damages (including - without limitation - lost profits, lost savings, business interruption, costs related to the removal or replacement of any products or rework charges) whether or not such damages are based on tort (including negligence), warranty, breach of contract or any other legal theory.

Notwithstanding any damages that customer might incur for any reason whatsoever, Nexperia's aggregate and cumulative liability towards customer for the products described herein shall be limited in accordance with the *Terms and conditions of commercial sale* of Nexperia.

Right to make changes — Nexperia reserves the right to make changes to information published in this document, including without limitation specifications and product descriptions, at any time and without notice. This document supersedes and replaces all information supplied prior to the publication hereof.

Suitability for use — Nexperia products are not designed, authorized or warranted to be suitable for use in medical, military, aircraft, space or life support equipment, nor in applications where failure or

malfunction of a Nexperia product can reasonably be expected to result in personal injury, death or severe property or environmental damage. Nexperia accepts no liability for inclusion and/or use of Nexperia products in such equipment or applications and therefore such inclusion and/or use is at the customer's own risk.

Applications — Applications that are described herein for any of these products are for illustrative purposes only. Nexperia makes no representation or warranty that such applications will be suitable for the specified use without further testing or modification.

Nexperia does not accept any liability related to any default, damage, costs or problem which is based on a weakness or default in the customer application/use or the application/use of customer's third party customer(s) (hereinafter both referred to as "Application"). It is customer's sole responsibility to check whether the Nexperia product is suitable and fit for the Application planned. Customer has to do all necessary testing for the Application in order to avoid a default of the Application and the product. Nexperia does not accept any liability in this respect.

Limiting values — Stress above one or more limiting values (as defined in the Absolute Maximum Ratings System of IEC 60134) will cause permanent damage to the device. Limiting values are stress ratings only and (proper) operation of the device at these or any other conditions above those given in the Recommended operating conditions section (if present) or the Characteristics sections of this document is not warranted. Constant or repeated exposure to limiting values will permanently and irreversibly affect the quality and reliability of the device.

Terms and conditions of commercial sale — Nexperia products are sold subject to the general terms and conditions of commercial sale, as published at <http://www.nexperia.com/profile/terms>, unless otherwise agreed in a valid written individual agreement. In case an individual agreement is concluded only the terms and conditions of the respective agreement shall apply. Nexperia hereby expressly objects to applying the customer's general terms and conditions with regard to the purchase of Nexperia products by customer.

No offer to sell or license — Nothing in this document may be interpreted or construed as an offer to sell products that is open for acceptance or the grant, conveyance or implication of any license under any copyrights, patents or other industrial or intellectual property rights.

Export control — This document as well as the item(s) described herein may be subject to export control regulations. Export might require a prior authorization from national authorities.

Quick reference data — The Quick reference data is an extract of the product data given in the Limiting values and Characteristics sections of this document, and as such is not complete, exhaustive or legally binding.

13.4 Trademarks

Notice: All referenced brands, product names, service names and trademarks are the property of their respective owners.

14. Contact information

For more information, please visit: <http://www.nexperia.com>

For sales office addresses, please send an email to: salesaddresses@nexperia.com

15. Contents

1	Product profile	1
1.1	General description	1
1.2	Features and benefits	1
1.3	Applications	1
1.4	Quick reference data	1
2	Pinning information	2
3	Ordering information	3
4	Marking	3
5	Limiting values	3
6	Thermal characteristics	4
7	Characteristics	4
8	Test information	6
9	Package outline	7
10	Packing information	7
11	Soldering	8
12	Revision history	10
13	Legal information	11
13.1	Data sheet status	11
13.2	Definitions	11
13.3	Disclaimers	11
13.4	Trademarks	11
14	Contact information	12
15	Contents	13



Компания «ЭлектроПласт» предлагает заключение долгосрочных отношений при поставках импортных электронных компонентов на взаимовыгодных условиях!

Наши преимущества:

- Оперативные поставки широкого спектра электронных компонентов отечественного и импортного производства напрямую от производителей и с крупнейших мировых складов;
- Поставка более 17-ти миллионов наименований электронных компонентов;
- Поставка сложных, дефицитных, либо снятых с производства позиций;
- Оперативные сроки поставки под заказ (от 5 рабочих дней);
- Экспресс доставка в любую точку России;
- Техническая поддержка проекта, помощь в подборе аналогов, поставка прототипов;
- Система менеджмента качества сертифицирована по Международному стандарту ISO 9001;
- Лицензия ФСБ на осуществление работ с использованием сведений, составляющих государственную тайну;
- Поставка специализированных компонентов (Xilinx, Altera, Analog Devices, Intersil, Interpoint, Microsemi, Aeroflex, Peregrine, Syfer, Eurofarad, Texas Instrument, Miteq, Cobham, E2V, MA-COM, Hittite, Mini-Circuits, General Dynamics и др.);

Помимо этого, одним из направлений компании «ЭлектроПласт» является направление «Источники питания». Мы предлагаем Вам помощь Конструкторского отдела:

- Подбор оптимального решения, техническое обоснование при выборе компонента;
- Подбор аналогов;
- Консультации по применению компонента;
- Поставка образцов и прототипов;
- Техническая поддержка проекта;
- Защита от снятия компонента с производства.



Как с нами связаться

Телефон: 8 (812) 309 58 32 (многоканальный)

Факс: 8 (812) 320-02-42

Электронная почта: org@eplast1.ru

Адрес: 198099, г. Санкт-Петербург, ул. Калинина, дом 2, корпус 4, литера А.