

General Specifications

Electrical Capacity (Resistive Load)

- Power Level (silver):** 6A @ 125V AC & 3A @ 250V AC
4A @ 30V DC for On-None-On & On-None-Off; 3A @ 30V DC for all other circuits
- Logic Level (gold):** 0.4VA maximum @ 28V AC/DC maximum (Applicable Range 0.1mA ~ 0.1A @ 20mV ~ 28V)
- Logic/Power Level (gold over silver):** Combines silver & gold ratings
Note: Find additional explanation of dual rating & operating range in Supplement section.

Other Ratings

- Contact Resistance:** 10 milliohms maximum for silver; 20 milliohms maximum for gold
- Insulation Resistance:** 1,000 megohms minimum @ 500V DC
- Dielectric Strength:** 1,000V AC minimum between contacts for 1 minute minimum;
1,500V AC minimum between contacts and case for 1 minute minimum
- Mechanical Life:** 100,000 operations minimum; 50,000 operations minimum for flat, locking & splashproof devices
- Electrical Life:** 25,000 operations minimum for silver; 50,000 operations minimum for gold;
50,000 operations minimum for silver at 3A @ 125V AC
- Angle of Throw:** 25°

Materials & Finishes

- Toggle:** Brass with chrome plating
- Bushing:** Brass with nickel plating
- Case:** Diallyl phthalate resin (UL94V-0)
- Movable Contactor:** Phosphor bronze with silver or gold plating
- Movable Contacts:** Silver alloy (code W); copper with gold plating (code G); or silver alloy with gold plating (code A)
- Stationary Contacts:** Silver with silver plating (code W); copper or brass with gold plating (code G);
or silver with gold plating (code A)
- Terminals:** Copper or brass with silver plating; or copper or brass with gold plating
- Frame:** Stainless steel
- Support Bracket:** Brass with tin plating

Environmental Data

- Operating Temp Range:** -30°C through +85°C (-22°F through +185°F)
- Humidity:** 90 ~ 95% humidity for 96 hours @ 40°C (104°F)
- Vibration:** 10 ~ 55Hz with peak-to-peak amplitude of 1.5mm traversing the frequency range & returning in 1 minute; 3 right angled directions for 2 hours
- Shock:** 50G (490m/s²) acceleration (tested in 6 right angled directions, with 5 shocks in each direction)
- Sealing:** Splashproof bushing options B3, D3, D8, L3, & L8, which have o-rings inside & outside the bushing, meet IP67 of IEC60529 Standards.

Installation

- Mounting Torque:** 3.0Nm (26.55 lb•in) double nut for large bushing;
1.5Nm (13 lb•in) double nut & 0.7Nm (6 lb•in) single nut for all other bushings

Processing

- Soldering:** Wave Soldering (PC version) for Gold: See Profile A in Supplement section.
Manual Soldering for Gold: See Profile A in Supplement section.
Wave Soldering (PC version) for Silver: See Profile B in Supplement section.
Manual Soldering for Silver: See Profile B in Supplement section.
Note: Lever must be in OFF (center) position while soldering.
- Cleaning:** These devices are not process sealed. Hand clean locally using alcohol based solution.

Standards & Certifications

- Flammability Standards:** UL94V-0 for case
- UL:** **File No. E44145 - Recognized only when ordered with marking on switch.**
Add "/U" or "/CUL" before dash in part number to order UL recognized switch.
All models recognized at 6A @ 125V AC, 3A @ 250V AC or 0.4VA maximum @ 28V DC maximum.
- CSA:** **File No. 023535_0_000 - Certified only when ordered with marking on switch.**
Add "/C" before dash in part number to order CSA certified switch.
All models certified at 6A @ 125V AC or 3A @ 250V AC or 0.4VA maximum @ 28V maximum.

Distinctive Characteristics

Antirotation design, standard on noncylindrical levers, mates toggle and bushing; bottom of toggle has two flatted sides which fit into a complementary opening inside bushing.

Antijamming design protects contacts from damage due to excessive downward force on actuator.

High torque bushing construction prevents rotation or separation from frame during installation.

High insulating barriers increase isolation of circuits in multipole devices and provide added protection to contact points.

Molded diallyl phthalate case has a UL flammability rating of 94V-0.

Epoxy sealed terminals prevent entry of solder flux and other contaminants.

Prominent external insulating barriers increase insulation resistance and dielectric strength.

Interlocked actuator block, lever, and interior guide prevent switch failure due to biased lever movement.

Clinching of frame to case well above base and terminals provides 1,500V dielectric strength.

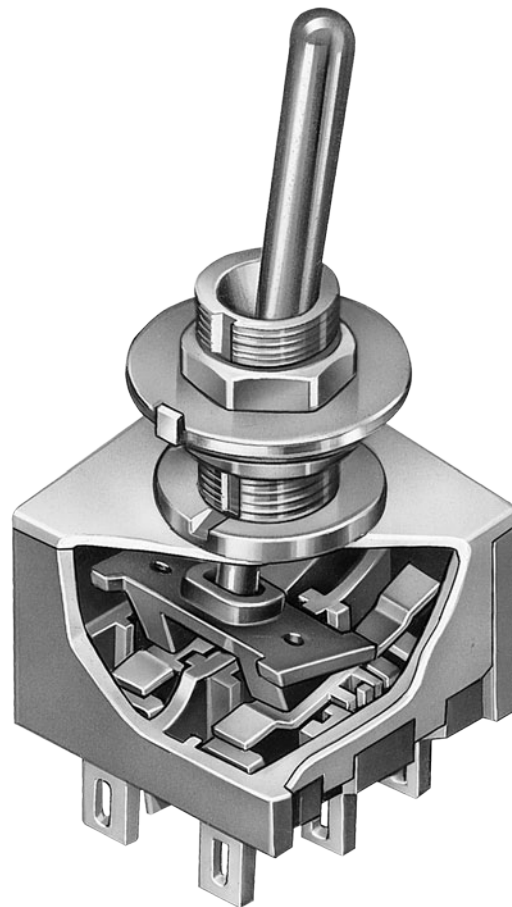

Actual Size

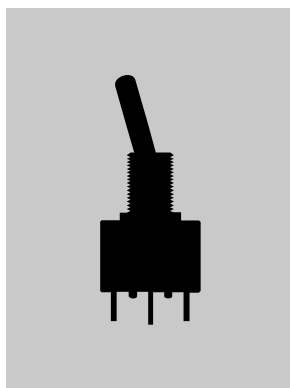

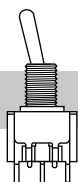
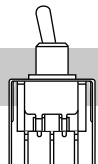
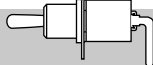
| | | |
|---|------------------|----------|
|  | Bushing Mount | Page A48 |
|  | Bracket PC Mount | Page A60 |
|  | Angle PC Mount | Page A66 |

A Toggles

Rockers

Pushbuttons

Illuminated PB

Programmable

Keylocks

Rotaries

Slides

Tactiles

Tilt

Touch

Indicators

Accessories

Supplement

TYPICAL SWITCH ORDERING EXAMPLE

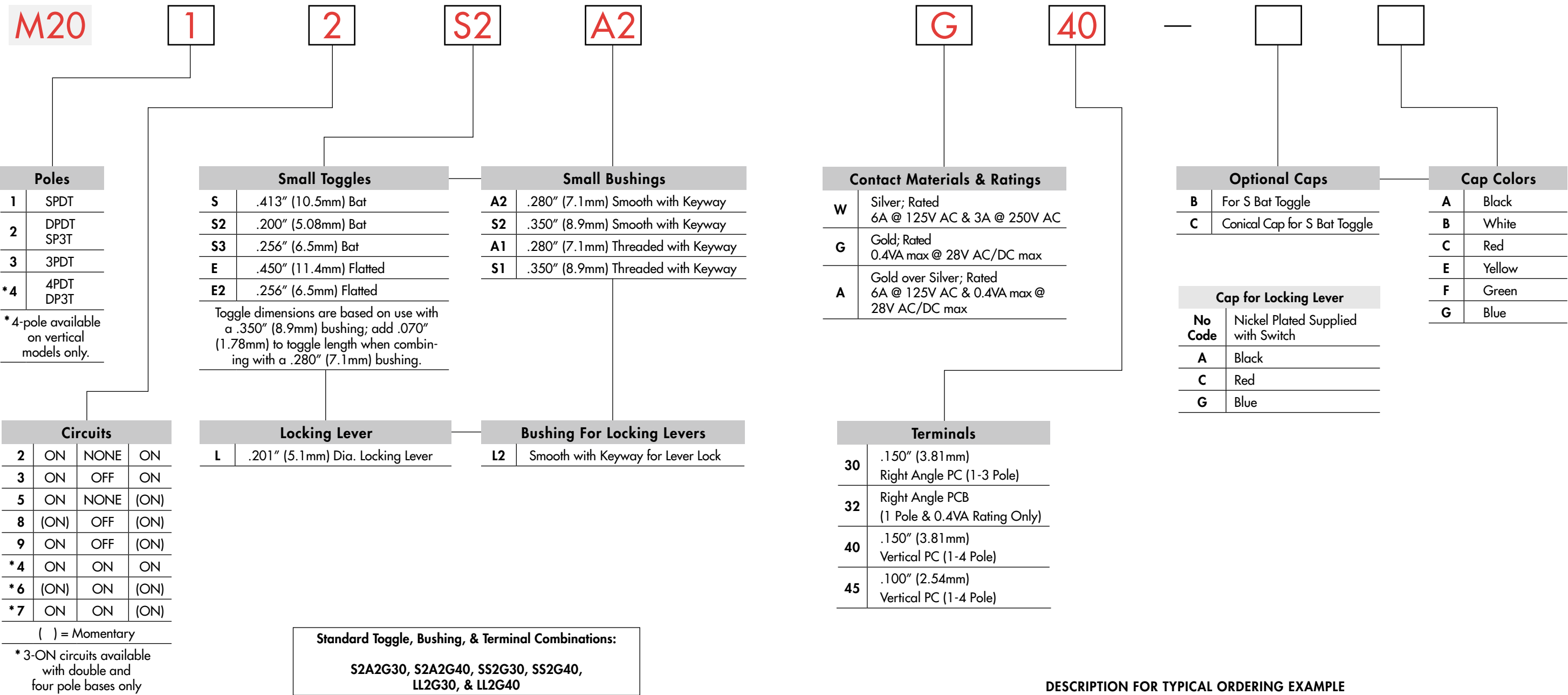

DESCRIPTION FOR TYPICAL ORDERING EXAMPLE

M2012S2A2G40

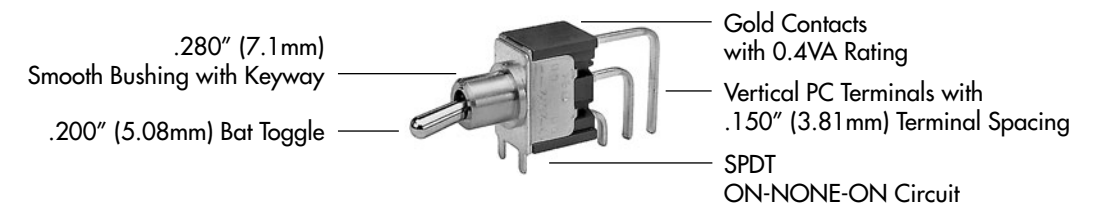







IMPORTANT:



Switches are supplied without UL, cULus & CSA marking unless specified. **UL, cULus & CSA recognized only when ordered with marking on the switch.** Specific models, ratings, & ordering instructions are noted on General Specifications page.

POLES & CIRCUITS

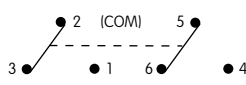
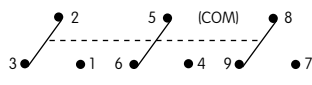
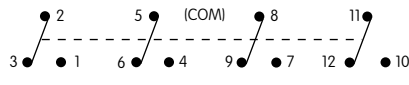
| Pole | Model | Toggle Position () = Momentary | | | Connected Terminals | | | Throw & Schematics |
|------|---|---|---|---|---|---|---|--|
| | | Down  | Center  | Up  | Down  | Center  | Up  | |
| SP | *M2012 *M2013 *M2015 *M2018 M2019 | ON ON ON (ON) ON | NONE OFF NONE OFF OFF | ON ON (ON) (ON) (ON) | 2-3 | OPEN | 2-1 | Note: Terminal numbers are not actually on the switch. * Reverse circuits available for vertical mount SP & DP upon request.  |
| DP | *M2022 *M2023 *M2025 *M2028 M2029 | ON ON ON (ON) ON | NONE OFF NONE OFF OFF | ON ON (ON) (ON) (ON) | 2-3 5-6 | OPEN | 2-1 5-4 |  |
| 3P | M2032 M2033 M2035 M2038 M2039 | ON ON ON (ON) ON | NONE OFF NONE OFF OFF | ON ON (ON) (ON) (ON) | 2-3 5-6 8-9 | OPEN | 2-1 5-4 8-7 |  |
| 4P | M2042 M2043 M2045 M2048 M2049 | ON ON ON (ON) ON | NONE OFF NONE OFF OFF | ON ON (ON) (ON) (ON) | 2-3 5-6 8-9 11-12 | OPEN | 2-1 5-4 8-7 11-10 |  |

For 3 Throw (3-On)

Connected Terminals & Schematics

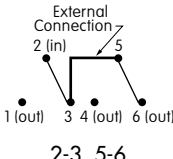
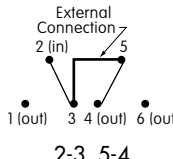
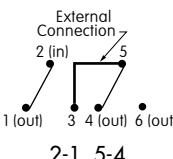
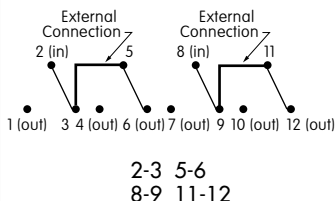
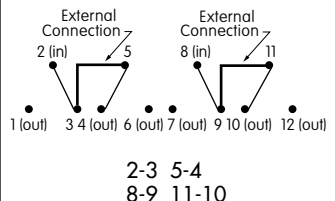
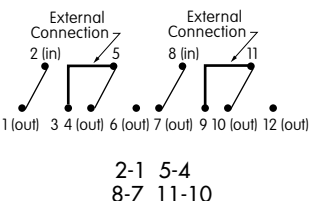
| Pole | Model | Down | Center | Up | Down | Center | Up |
|------|-------------------------|------------------|----------------|--------------------|---|--|---|
| SP | M2024 M2026 M2027 | ON (ON) ON | ON ON ON | ON (ON) (ON) |  2-3 5-6 |  2-3 5-4 |  2-1 5-4 |
| DP | M2044 M2046 M2047 | ON (ON) ON | ON ON ON | ON (ON) (ON) |  2-3 5-6 8-9 11-12 |  2-3 5-4 8-9 11-10 |  2-1 5-4 8-7 11-10 |

The SP3T model utilizes a double pole base.

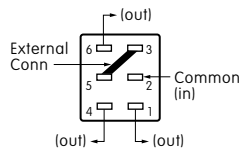

External connection must be made during field installation.

The DP3T model utilizes a four pole base.

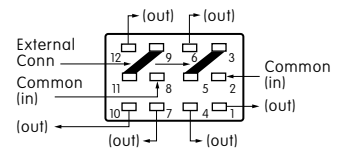

External connection must be made during field installation.

SMALL TOGGLES

Important:

Toggle length changes based on bushing selected. All illustrations are shown with .350" (8.9mm) long bushing. When using a .280" (7.1mm) long bushing, toggle length increases .070" (1.78mm).

S .413" (10.5mm)
Bat

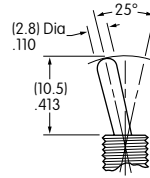

S2 .200" (5.08mm)
Bat

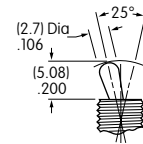

S3 .256" (6.5mm)
Bat

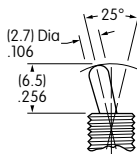

E .450" (11.4mm)
Flatted

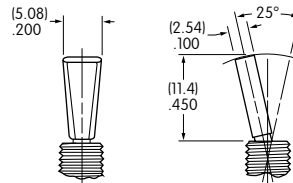

E2 .256" (6.5mm)
Flatted

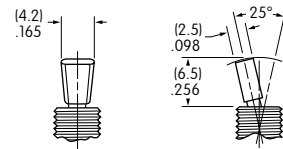

Standard Material & Finish: Brass with Bright Chrome
Contact factory for optional finishes.

SMALL BUSHINGS

A2 .280" (7.1mm)
Smooth with Keyway

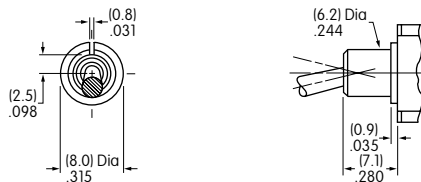

S2 .350" (8.9mm)
Smooth with Keyway

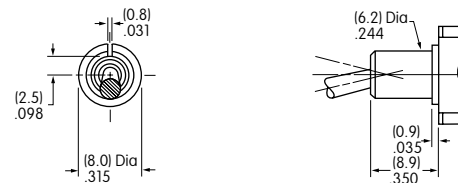

When using this bushing, toggle length is increased by .070" (1.78mm).

A1 .280" (7.1mm)
Threaded with Keyway

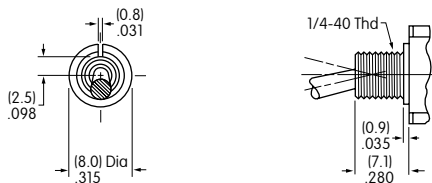

S1 .350" (8.9mm)
Threaded with Keyway

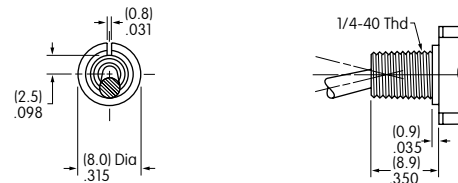

When using this bushing, toggle length is increased by .070" (1.78mm). Maximum Panel Thickness with Standard Hardware: .031" (0.8mm)

Maximum Panel Thickness with Standard Hardware: .102" (2.6mm)

Panel Cutouts

For A2, S2, A1 or S1 Bushing with Keyway

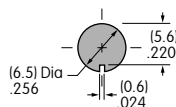

For A1 or S1 Bushing with Locking Ring

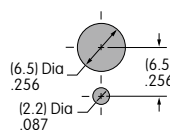

Standard Hardware:

- 2 Hex Nuts (AT513H)
- 1 Lockwasher (AT509)
- 1 Locking Ring (AT507H)

For dimensions, see Accessories & Hardware section.

LOCKING LEVER & BUSHING

LL2 Smooth with Keyway

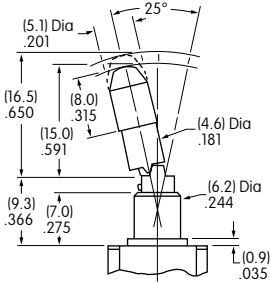
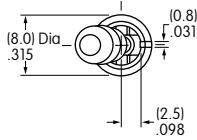

2 positions lock



1 position locks



2 positions lock

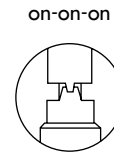

3 positions lock

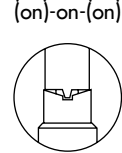

1 position locks

No Code

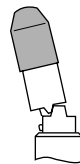

Cap for Locking Lever
 Supplied with Cap AT427
Material & Finish:
 Brass with Nickel Plating
Lever Material & Finish:
 Brass with Chrome Plating

Color Codes for Optional Anodized Aluminum Caps

| | | | |
|----------|-------|----------|-----|
| A | Black | C | Red |
| G | Blue | | |

CONTACT MATERIALS & RATINGS

W Silver over Silver **Power Level** 6A @ 125V AC & 3A @ 250V AC

G Gold over Brass or Copper **Logic Level** 0.4VA maximum @ 28V AC/DC maximum

Note: See Supplement section to find complete explanation of operating range.

A Gold over Silver **Power Level or Logic Level** 6A @ 125V AC or 0.4VA maximum @ 28V AC/DC maximum

Note: This dual rated option is suitable when two or more identical switches are used in logic and in power circuits within the same application. See Supplement section to find complete explanation of dual rating and operating range.

TERMINALS

30 .150" (3.81 mm) Right Angle PC (1-3 Pole)

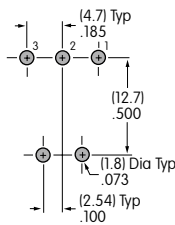
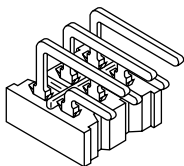

Single Pole

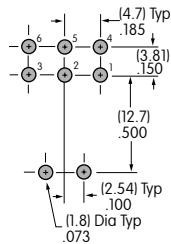

Double Pole

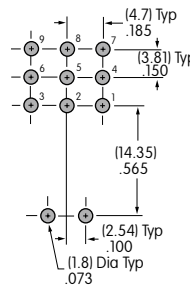

Three Pole

32 Right Angle PCB with Reverse Circuit (1 Pole & 0.4VA Rating Only)

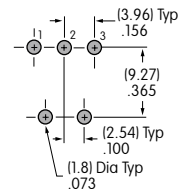
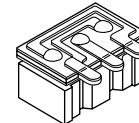

Terminal dimensions are shown on the Typical Switch Dimensions pages which follow.

TERMINALS (Continued)

A
Toggles

40 .150" (3.81mm)
Vertical PC (1-4 Pole)

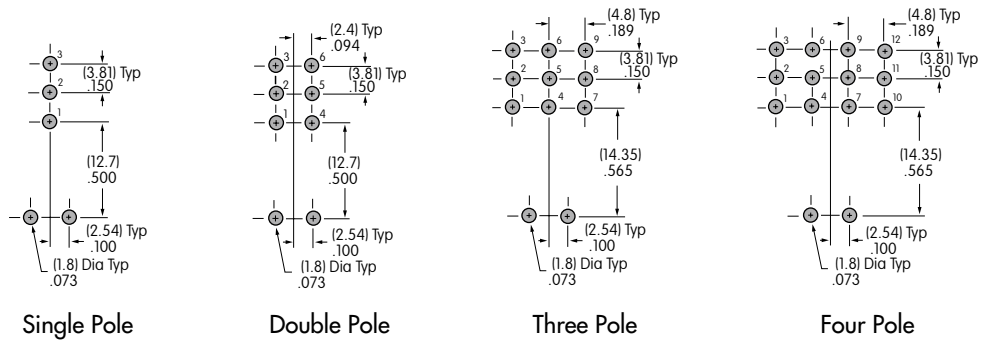
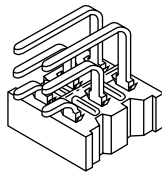

45 .100" (2.54mm)
Vertical PC (1-4 Pole)

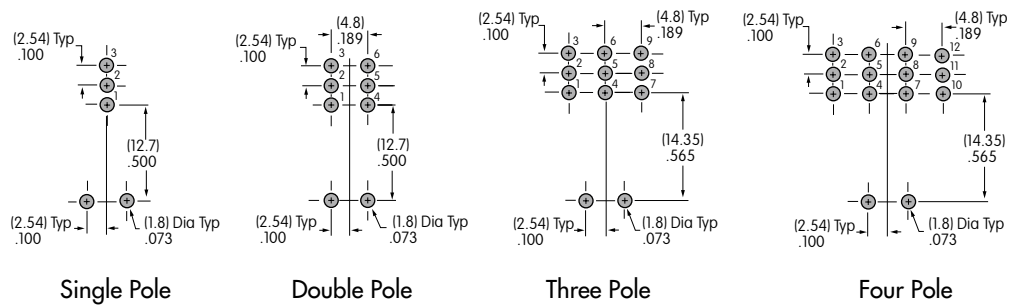
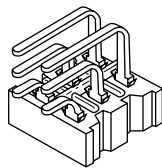

Terminal dimensions are shown on the Typical Switch Dimensions pages which follow.

Rockers

Pushbuttons

Illuminated PB

Programmable

Keylocks

Rotaries

OPTIONAL CAPS & CAP COLORS

B AT415
for S Bat Toggle

Material:
Polyethylene

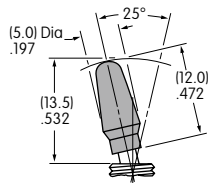

C AT444
Conical Cap for S Bat Toggle

Material:
Polyethylene

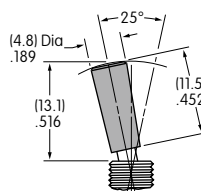

Colors Available

- | | |
|----------------|-----------------|
| A Black | E Yellow |
| B White | F Green |
| C Red | G Blue |

Slides

Tactiles

Tilt

STANDARD HARDWARE

AT513H for Inch
AT513M for Metric
Hex Nut (2 per switch)
Brass/Nickel

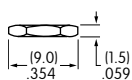
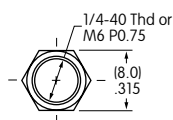

AT507H for Inch
AT507M for Metric
Locking Ring (1 per switch)
Steel with Zinc/Chromate

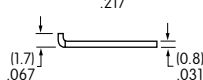
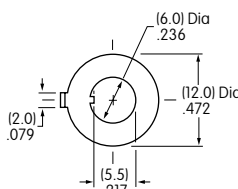

AT509
Lockwasher (1 per switch, none with splashproof)
Steel with Zinc/Chromate

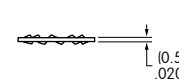
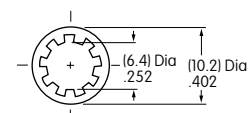

Touch

Indicators

Accessories

Supplement

TYPICAL SWITCH DIMENSIONS

.150" (3.81mm) Right Angle PC

Single Pole

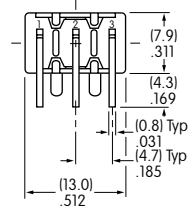
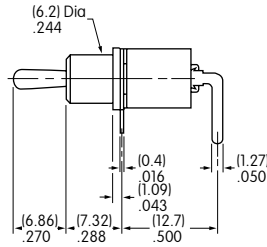
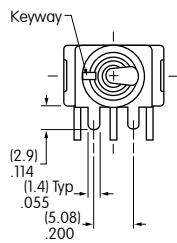

M2012S2A2G30

.150" (3.81mm) Right Angle PC

Double Pole

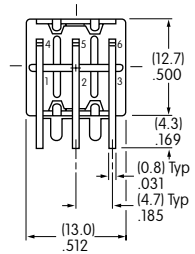
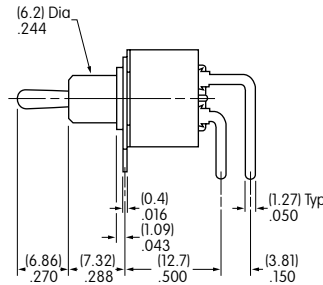
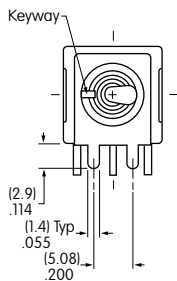

M2022S2A2G30

.150" (3.81mm) Right Angle PC

Three Pole

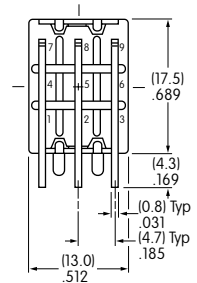
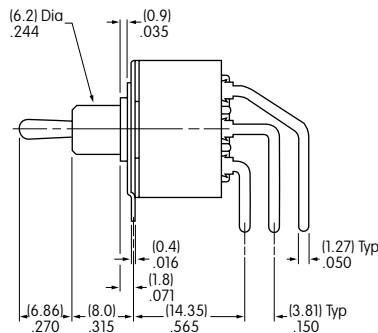
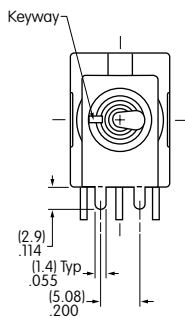
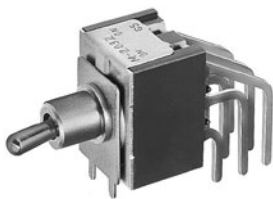

M2032S2A2G30

Right Angle PCB

Single Pole • Reverse Circuit

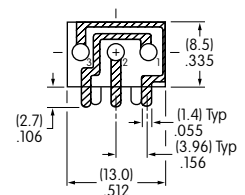
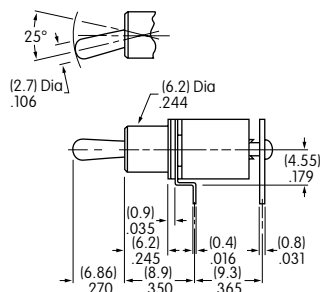
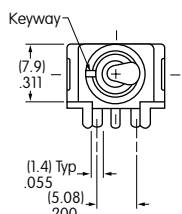

M2012S2A2G32

TYPICAL SWITCH DIMENSIONS

Single Pole

.150" (3.81mm) Vertical PC

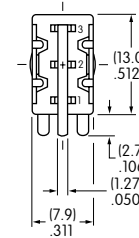
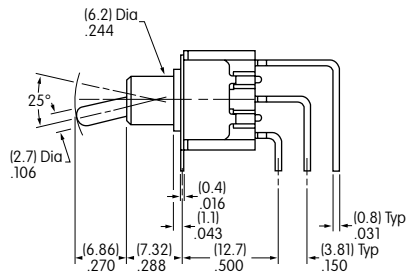
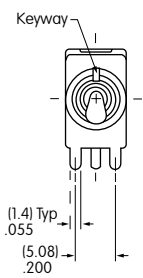

M2012S2A2G40

Double Pole

.150" (3.81mm) Vertical PC

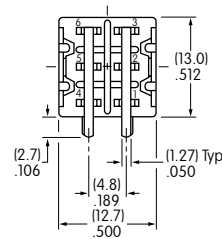
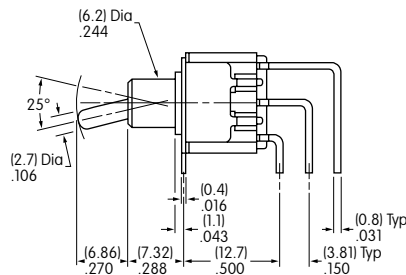
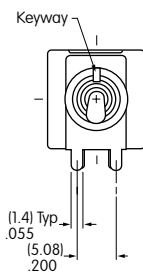

M2022S2A2G40

Three Pole

.150" (3.81mm) Vertical PC

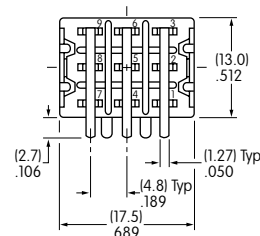
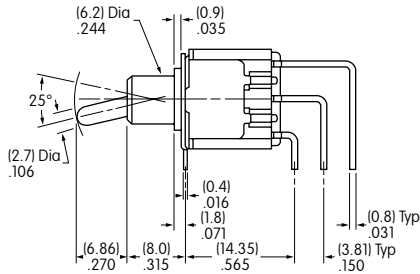
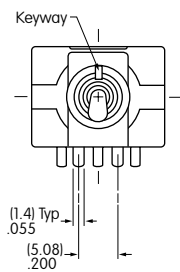

M2032S2A2G40

Four Pole

.150" (3.81mm) Vertical PC

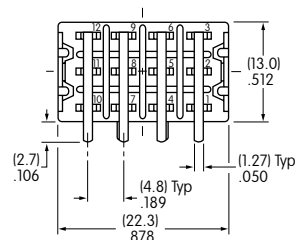
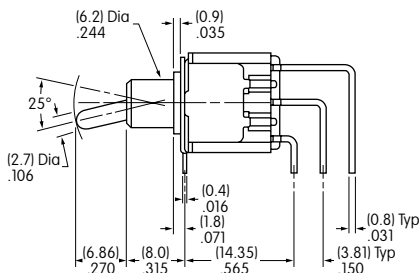
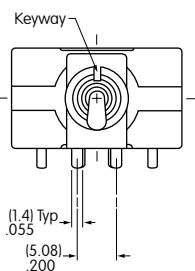

M2042S2A2G40

A
Toggles

Rockers

Pushbuttons

Illuminated PB

Programmable

Keylocks

Rotaries

Slides

Tactiles

Tilt

Touch

Indicators

Accessories

Supplement

TYPICAL SWITCH DIMENSIONS

.100" (2.54mm) Vertical PC

Single Pole

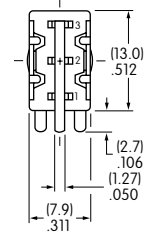
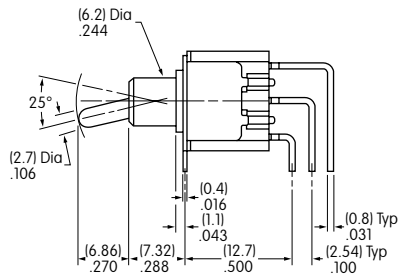
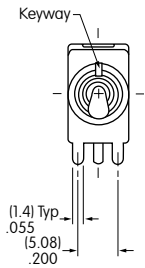

M2012S2A2G45

.100" (2.54mm) Vertical PC

Double Pole

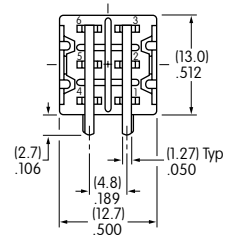
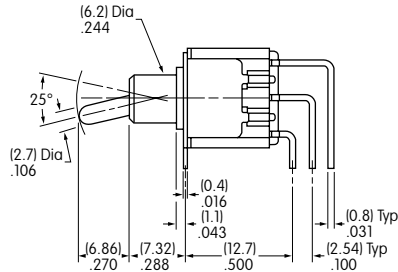
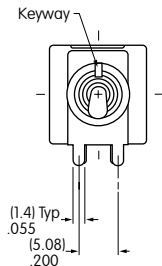

M2022S2A2G45

.100" (2.54mm) Vertical PC

Three Pole

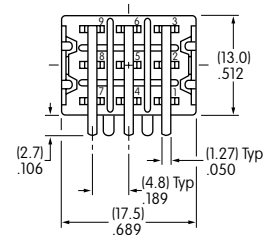
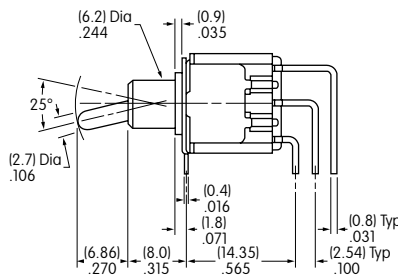
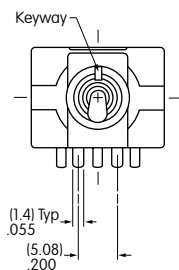

M2032S2A2G45

.100" (2.54mm) Vertical PC

Four Pole

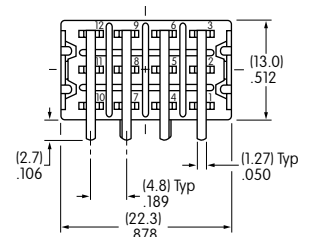
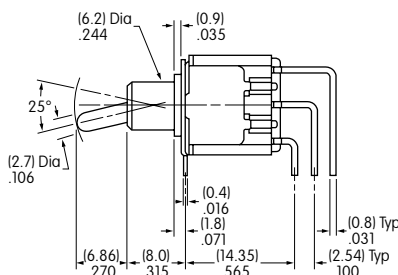
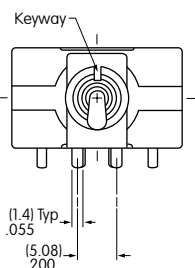

M2042S2A2G45



Компания «ЭлектроПласт» предлагает заключение долгосрочных отношений при поставках импортных электронных компонентов на взаимовыгодных условиях!

Наши преимущества:

- Оперативные поставки широкого спектра электронных компонентов отечественного и импортного производства напрямую от производителей и с крупнейших мировых складов;
- Поставка более 17-ти миллионов наименований электронных компонентов;
- Поставка сложных, дефицитных, либо снятых с производства позиций;
- Оперативные сроки поставки под заказ (от 5 рабочих дней);
- Экспресс доставка в любую точку России;
- Техническая поддержка проекта, помощь в подборе аналогов, поставка прототипов;
- Система менеджмента качества сертифицирована по Международному стандарту ISO 9001;
- Лицензия ФСБ на осуществление работ с использованием сведений, составляющих государственную тайну;
- Поставка специализированных компонентов (Xilinx, Altera, Analog Devices, Intersil, Interpoint, Microsemi, Aeroflex, Peregrine, Syfer, Eurofarad, Texas Instrument, Miteq, Cobham, E2V, MA-COM, Hittite, Mini-Circuits, General Dynamics и др.);

Помимо этого, одним из направлений компании «ЭлектроПласт» является направление «Источники питания». Мы предлагаем Вам помощь Конструкторского отдела:

- Подбор оптимального решения, техническое обоснование при выборе компонента;
- Подбор аналогов;
- Консультации по применению компонента;
- Поставка образцов и прототипов;
- Техническая поддержка проекта;
- Защита от снятия компонента с производства.



Как с нами связаться

Телефон: 8 (812) 309 58 32 (многоканальный)

Факс: 8 (812) 320-02-42

Электронная почта: org@eplast1.ru

Адрес: 198099, г. Санкт-Петербург, ул. Калинина, дом 2, корпус 4, литера А.