



3.3V CMOS Static RAM 4 Meg (256K x 16-Bit)

IDT71V416S
IDT71V416L

Features

- ◆ 256K x 16 advanced high-speed CMOS Static RAM
- ◆ JEDEC Center Power / GND pinout for reduced noise.
- ◆ Equal access and cycle times
 - Commercial and Industrial: 10/12/15ns
- ◆ One Chip Select plus one Output Enable pin
- ◆ Bidirectional data inputs and outputs directly LVTTTL-compatible
- ◆ Low power consumption via chip deselect
- ◆ Upper and Lower Byte Enable Pins
- ◆ Single 3.3V power supply
- ◆ Available in 44-pin, 400 mil plastic SOJ package and a 44-pin, 400 mil TSOP Type II package and a 48 ball grid array, 9mm x 9mm package.
- ◆ Green parts available, see ordering information

Description

The IDT71V416 is a 4,194,304-bit high-speed Static RAM organized as 256K x 16. It is fabricated using high-performance, high-reliability CMOS technology. This state-of-the-art technology, combined with innovative circuit design techniques, provides a cost-effective solution for high-speed memory needs.

The IDT71V416 has an output enable pin which operates as fast as 5ns, with address access times as fast as 10ns. All bidirectional inputs and outputs of the IDT71V416 are LVTTTL-compatible and operation is from a single 3.3V supply. Fully static asynchronous circuitry is used, requiring no clocks or refresh for operation.

The IDT71V416 is packaged in a 44-pin, 400 mil Plastic SOJ and a 44-pin, 400 mil TSOP Type II package and a 48 ball grid array, 9mm x 9mm package.

Functional Block Diagram



3624 drw 01

NOVEMBER 2016

Pin Configurations - SOJ/TSOP



3624 drw 02

*Pin 28 can either be a NC or connected to Vss

Top View

Pin Descriptions

A0 - A17	Address Inputs	Input
CS	Chip Select	Input
WE	Write Enable	Input
OE	Output Enable	Input
BHE	High Byte Enable	Input
BLE	Low Byte Enable	Input
I/O0 - I/O15	Data Input/Output	I/O
VDD	3.3V Power	Pwr
VSS	Ground	Gnd

3624 tbl 01

Pin Configurations - 48 BGA

71V416BE
BE48
48- BGA



3624 tbl 11

Top View

SOJ Capacitance

(TA = +25°C, f = 1.0MHz)

Symbol	Parameter ⁽¹⁾	Conditions	Max.	Unit
CIN	Input Capacitance	VIN = 3dV	7	pF
CIO	I/O Capacitance	VOUT = 3dV	8	pF

3624 tbl 02

48 BGA Capacitance

(TA = +25°C, f = 1.0MHz)

Symbol	Parameter ⁽¹⁾	Conditions	Max.	Unit
CIN	Input Capacitance	VIN = 3dV	6	pF
CIO	I/O Capacitance	VOUT = 3dV	7	pF

3624 tbl 02b

NOTE:

1. This parameter is guaranteed by device characterization, but not production tested.

Absolute Maximum Ratings⁽¹⁾

Symbol	Rating	Value	Unit
V _{DD}	Supply Voltage Relative to V _{SS}	-0.5 to +4.6	V
V _{IN} , V _{OUT}	Terminal Voltage Relative to V _{SS}	-0.5 to V _{DD} +0.5	V
T _{BIAS}	Temperature Under Bias	-55 to +125	°C
T _{STG}	Storage Temperature	-55 to +125	°C
P _T	Power Dissipation	1	W
I _{OUT}	DC Output Current	50	mA

3624 tbl 04

NOTE:

1. Stresses greater than those listed under ABSOLUTE MAXIMUM RATINGS may cause permanent damage to the device. This is a stress rating only and functional operation of the device at these or any other conditions above those indicated in the operational sections of this specification is not implied. Exposure to absolute maximum rating conditions for extended periods may affect reliability.

Recommended Operating Temperature and Supply Voltage

Grade	Temperature	V _{SS}	V _{DD}
Commercial	0°C to +70°C	0V	See Below
Industrial	-40°C to +85°C	0V	See Below

3624 tbl 05

Recommended DC Operating Conditions

Symbol	Parameter	Min.	Typ.	Max.	Unit
V _{DD}	Supply Voltage	3.0	3.3	3.6	V
V _{SS}	Ground	0	0	0	V
V _{IH}	Input High Voltage	2.0	—	V _{DD} +0.3 ⁽¹⁾	V
V _{IL}	Input Low Voltage	-0.3 ⁽²⁾	—	0.8	V

3624 tbl 06

NOTES:

1. V_{IH} (max.) = V_{DD}+2V for pulse width less than 5ns, once per cycle.
2. V_{IL} (min.) = -2V for pulse width less than 5ns, once per cycle.

Truth Table⁽¹⁾

\overline{CS}	\overline{OE}	\overline{WE}	\overline{BLE}	\overline{BHE}	I/O ₀ -I/O ₇	I/O ₈ -I/O ₁₅	Function
H	X	X	X	X	High-Z	High-Z	Deselected - Standby
L	L	H	L	H	DATA _{OUT}	High-Z	Low Byte Read
L	L	H	H	L	High-Z	DATA _{OUT}	High Byte Read
L	L	H	L	L	DATA _{OUT}	DATA _{OUT}	Word Read
L	X	L	L	L	DATA _{IN}	DATA _{IN}	Word Write
L	X	L	L	H	DATA _{IN}	High-Z	Low Byte Write
L	X	L	H	L	High-Z	DATA _{IN}	High Byte Write
L	H	H	X	X	High-Z	High-Z	Outputs Disabled
L	X	X	H	H	High-Z	High-Z	Outputs Disabled

3624 tbl 03

NOTE:

1. H = V_{IH}, L = V_{IL}, X = Don't care.

DC Electrical Characteristics

(VDD = Min. to Max., Commercial and Industrial Temperature Ranges)

Symbol	Parameter	Test Conditions	IDT71V416		Unit
			Min.	Max.	
I _{LI}	Input Leakage Current	V _{CC} = Max., V _{IN} = V _{SS} to V _{DD}	—	5	μA
I _{LO}	Output Leakage Current	V _{DD} = Max., \overline{CS} = V _{IH} , V _{OUT} = V _{SS} to V _{DD}	—	5	μA
V _{OL}	Output Low Voltage	I _{OL} = 8mA, V _{DD} = Min.	—	0.4	V
V _{OH}	Output High Voltage	I _{OH} = -4mA, V _{DD} = Min.	2.4	—	V

3624 tbl 07

DC Electrical Characteristics^(1, 2, 3)

(VDD = Min. to Max., V_{LC} = 0.2V, V_{HC} = V_{DD} - 0.2V)

Symbol	Parameter		71V416S/L10		71V416S/L12		71V416S/L15		Unit
			Com'l.	Ind.	Com'l.	Ind.	Com'l.	Ind.	
I _{CC}	Dynamic Operating Current $\overline{CS} \leq V_{LC}$, Outputs Open, V _{DD} = Max., f = f _{MAX} ⁽⁴⁾	S	200	200	180	180	170	170	mA
		L	180	180	170	170	160	160	
I _{SB}	Dynamic Standby Power Supply Current $\overline{CS} \geq V_{HC}$, Outputs Open, V _{DD} = Max., f = f _{MAX} ⁽⁴⁾	S	70	70	60	60	50	50	mA
		L	50	50	45	45	40	40	
I _{SB1}	Full Standby Power Supply Current (static) $\overline{CS} \geq V_{HC}$, Outputs Open, V _{DD} = Max., f = 0 ⁽⁴⁾	S	20	20	20	20	20	20	mA
		L	10	10	10	10	10	10	

3624 tbl 08

NOTES:

1. All values are maximum guaranteed values.
2. All inputs switch between 0.2V (Low) and V_{DD} - 0.2V (High).
3. Power specifications are preliminary.
4. f_{MAX} = 1/t_{rc} (all address inputs are cycling at f_{MAX}); f = 0 means no address input lines are changing.

AC Test Loads



3624 drw 03

Figure 1. AC Test Load

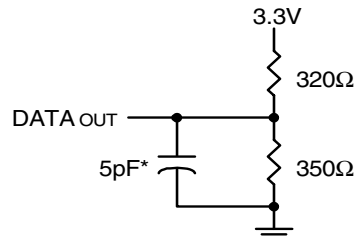

3624 drw 04

*Including jig and scope capacitance.

Figure 2. AC Test Load

(for t_{CLZ}, t_{OLZ}, t_{CHZ}, t_{OHZ}, t_{OW}, and t_{WHZ})

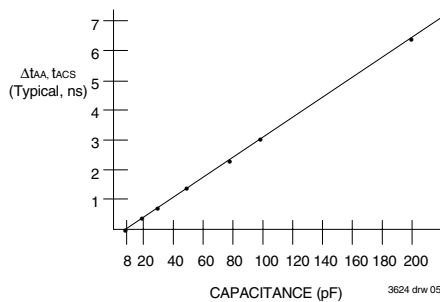

3624 drw 05

Figure 3. Output Capacitive Derating

AC Test Conditions

Input Pulse Levels	GND to 3.0V
Input Rise/Fall Times	1.5ns
Input Timing Reference Levels	1.5V
Output Reference Levels	1.5V
AC Test Load	Figures 1,2 and 3

3624 tbl 09

AC Electrical Characteristics

(VDD = Min. to Max., Commercial and Industrial Temperature Ranges)

Symbol	Parameter	71V416S/L10		71V416S/L12		71V416S/L15		Unit
		Min.	Max.	Min.	Max.	Min.	Max.	
READ CYCLE								
t _{RC}	Read Cycle Time	10	—	12	—	15	—	ns
t _{AA}	Address Access Time	—	10	—	12	—	15	ns
t _{ACS}	Chip Select Access Time	—	10	—	12	—	15	ns
t _{CLZ} ⁽¹⁾	Chip Select Low to Output in Low-Z	4	—	4	—	4	—	ns
t _{CHZ} ⁽¹⁾	Chip Select High to Output in High-Z	—	5	—	6	—	7	ns
t _{OE}	Output Enable Low to Output Valid	—	5	—	6	—	7	ns
t _{OLZ} ⁽¹⁾	Output Enable Low to Output in Low-Z	0	—	0	—	0	—	ns
t _{OHZ} ⁽¹⁾	Output Enable High to Output in High-Z	—	5	—	6	—	7	ns
t _{OH}	Output Hold from Address Change	4	—	4	—	4	—	ns
t _{BE}	Byte Enable Low to Output Valid	—	5	—	6	—	7	ns
t _{BLZ} ⁽¹⁾	Byte Enable Low to Output in Low-Z	0	—	0	—	0	—	ns
t _{BHZ} ⁽¹⁾	Byte Enable High to Output in High-Z	—	5	—	6	—	7	ns
WRITE CYCLE								
t _{WC}	Write Cycle Time	10	—	12	—	15	—	ns
t _{AW}	Address Valid to End of Write	8	—	8	—	10	—	ns
t _{CW}	Chip Select Low to End of Write	8	—	8	—	10	—	ns
t _{BW}	Byte Enable Low to End of Write	8	—	8	—	10	—	ns
t _{AS}	Address Set-up Time	0	—	0	—	0	—	ns
t _{WR}	Address Hold from End of Write	0	—	0	—	0	—	ns
t _{WP}	Write Pulse Width	8	—	8	—	10	—	ns
t _{DW}	Data Valid to End of Write	5	—	6	—	7	—	ns
t _{DH}	Data Hold Time	0	—	0	—	0	—	ns
t _{OW} ⁽¹⁾	Write Enable High to Output in Low-Z	3	—	3	—	3	—	ns
t _{WHZ} ⁽¹⁾	Write Enable Low to Output in High-Z	—	6	—	7	—	7	ns

3624 tbl 10

NOTE:

1. This parameter is guaranteed with the AC Load (Figure 2) by device characterization, but is not production tested.

Timing Waveform of Read Cycle No. 1^(1,2,3)

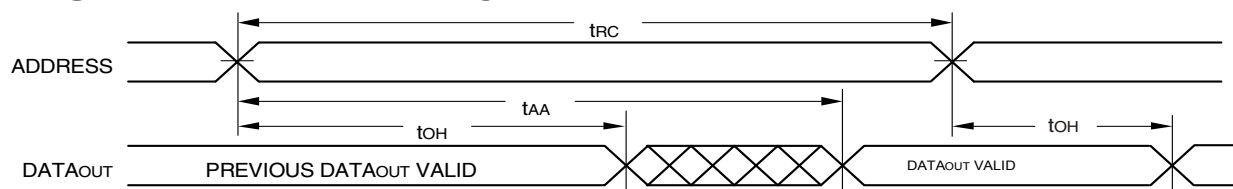

NOTES:

1. \overline{WE} is HIGH for Read Cycle.
2. Device is continuously selected, \overline{CS} is LOW.
3. \overline{OE} , \overline{BHE} , and \overline{BLE} are LOW.

3624 drw 06

Timing Waveform of Read Cycle No. 2⁽¹⁾

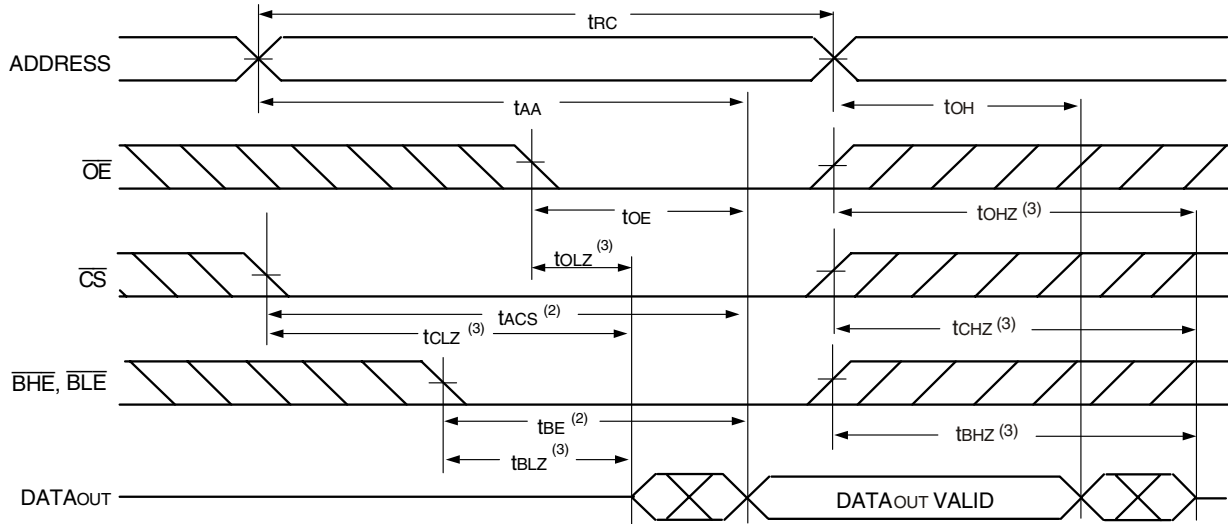

3624 drw 07

NOTES:

- \overline{WE} is HIGH for Read Cycle.
- Address must be valid prior to or coincident with the later of \overline{CS} , \overline{BHE} , or \overline{BLE} transition LOW; otherwise t_{AA} is the limiting parameter.
- Transition is measured $\pm 200\text{mV}$ from steady state.

Timing Waveform of Write Cycle No. 1 (\overline{WE} Controlled Timing)^(1,2,4)

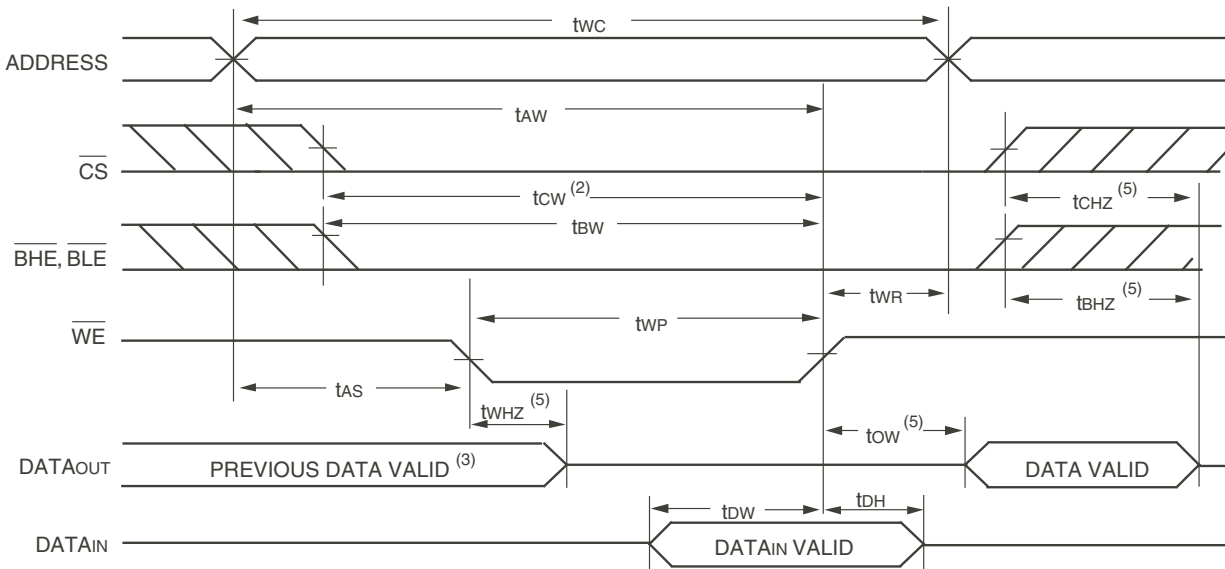

3624 drw 08

NOTES:

- A write occurs during the overlap of a LOW \overline{CS} , LOW \overline{BHE} or \overline{BLE} , and a LOW \overline{WE} .
- \overline{OE} is continuously HIGH. If during a \overline{WE} controlled write cycle \overline{OE} is LOW, t_{WP} must be greater than or equal to $t_{WHZ} + t_{DW}$ to allow the I/O drivers to turn off and data to be placed on the bus for the required t_{DW} . If \overline{OE} is HIGH during a \overline{WE} controlled write cycle, this requirement does not apply and the minimum write pulse is as short as the specified t_{WP} .
- During this period, I/O pins are in the output state, and input signals must not be applied.
- If the \overline{CS} LOW or \overline{BHE} and \overline{BLE} LOW transition occurs simultaneously with or after the \overline{WE} LOW transition, the outputs remain in a high-impedance state.
- Transition is measured $\pm 200\text{mV}$ from steady state.

Timing Waveform of Write Cycle No. 2 ($\overline{\text{CS}}$ Controlled Timing)^(1,3)

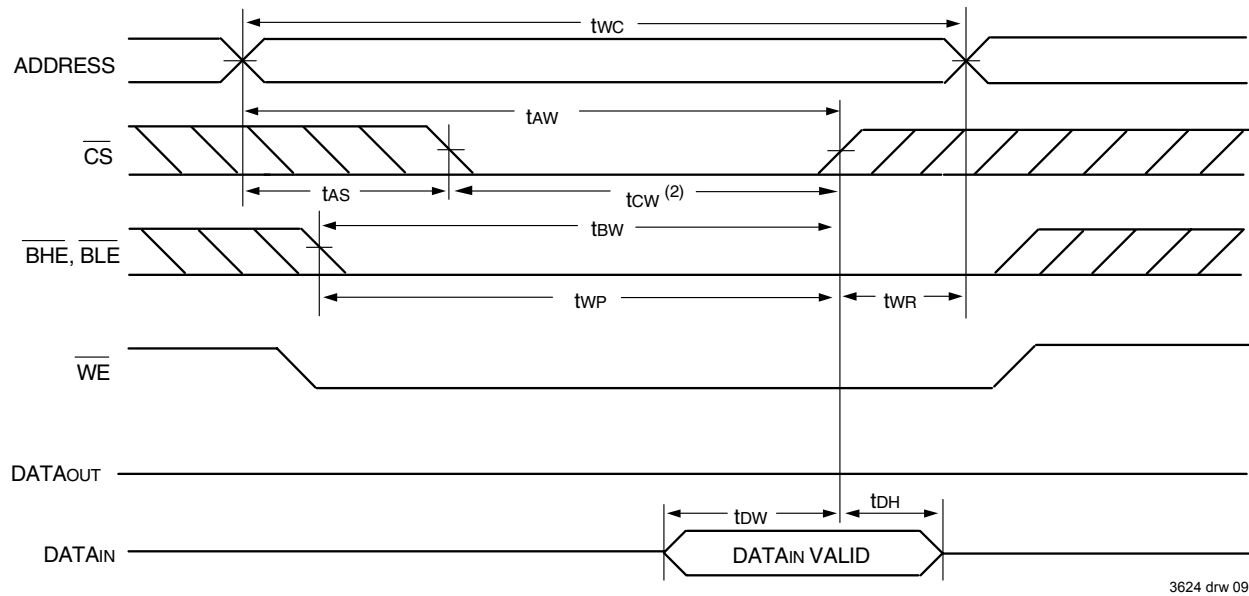

Timing Waveform of Write Cycle No. 3 ($\overline{\text{BHE}}$, $\overline{\text{BLE}}$ Controlled Timing)^(1,3)

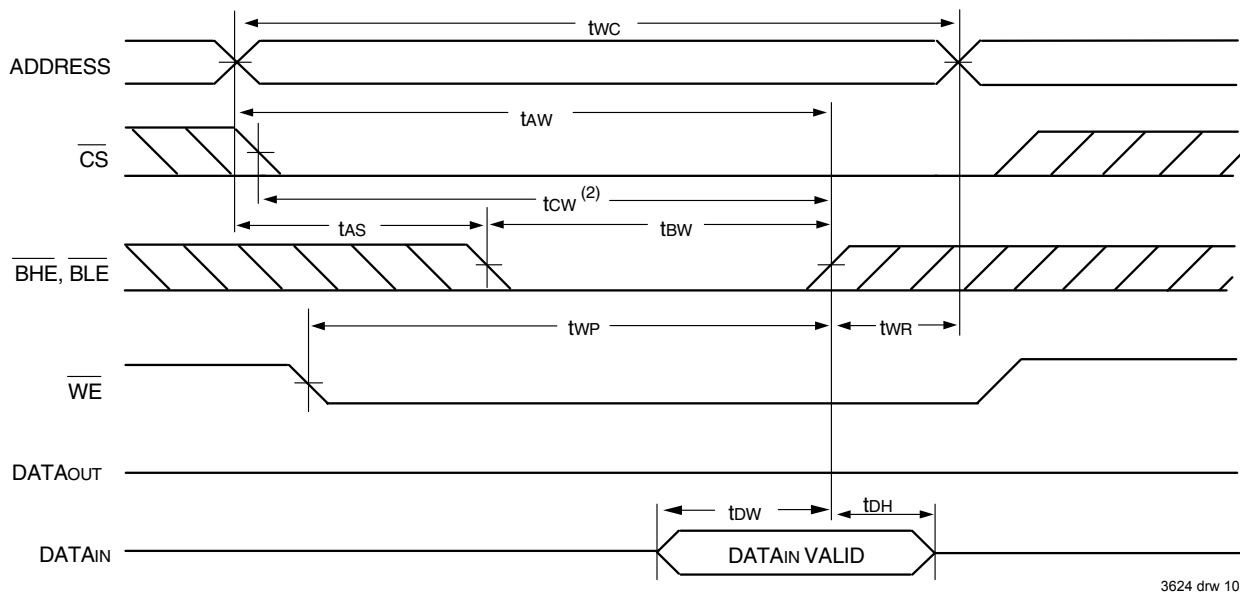

NOTES:

1. A write occurs during the overlap of a LOW $\overline{\text{CS}}$, LOW $\overline{\text{BHE}}$ or $\overline{\text{BLE}}$, and a LOW $\overline{\text{WE}}$.
2. During this period, I/O pins are in the output state, and input signals must not be applied.
3. If the $\overline{\text{CS}}$ LOW or $\overline{\text{BHE}}$ and $\overline{\text{BLE}}$ LOW transition occurs simultaneously with or after the $\overline{\text{WE}}$ LOW transition, the outputs remain in a high-impedance state.

Ordering Information



Orderable Part Information

3624 drw 11a

Speed (ns)	Orderable Part ID	Pkg. Code	Pkg. Type	Temp. Grade
10	71V416L10BE	BE48	CABGA	C
	71V416L10BEG	BEG48	CABGA	C
	71V416L10BEG8	BEG48	CABGA	C
	71V416L10PHG	PHG44	TSOP	C
	71V416L10PHG8	PHG44	TSOP	C
	71V416L10PHGI	PHG44	TSOP	I
	71V416L10PHGI8	PHG44	TSOP	I
	71V416L10YG	PBG44	SOJ	C
	71V416L10YG8	PBG44	SOJ	C
12	71V416L12BE	BE48	CABGA	C
	71V416L12BE8	BE48	CABGA	C
	71V416L12BEG	BEG48	CABGA	C
	71V416L12BEG8	BEG48	CABGA	C
	71V416L12BEGI	BEG48	CABGA	I
	71V416L12BEGI8	BEG48	CABGA	I
	71V416L12BEI	BE48	CABGA	I
	71V416L12BEI8	BE48	CABGA	I
	71V416L12PHG	PHG44	TSOP	C
	71V416L12PHG8	PHG44	TSOP	C
	71V416L12PHGI	PHG44	TSOP	I
	71V416L12PHGI8	PHG44	TSOP	I
	71V416L12YG	PBG44	SOJ	C
	71V416L12YG8	PBG44	SOJ	C
	71V416L12YGI	PBG44	SOJ	I
	71V416L12YGI8	PBG44	SOJ	I

3624 tbl 12a

Speed (ns)	Orderable Part ID	Pkg. Code	Pkg. Type	Temp. Grade	
10	71V416S10BE	BE48	CABGA	C	
	71V416S10BE8	BE48	CABGA	C	
	71V416S10BEG	BEG48	CABGA	C	
	71V416S10BEG8	BEG48	CABGA	C	
	71V416S10PHG	PHG44	TSOP	C	
	71V416S10PHG8	PHG44	TSOP	C	
	71V416S10PHGI	PHG44	TSOP	I	
	71V416S10PHGI8	PHG44	TSOP	I	
	71V416S10YG	PBG44	SOJ	C	
	71V416S10YG8	PBG44	SOJ	C	
	12	71V416S12BE	BE48	CABGA	C
		71V416S12BE8	BE48	CABGA	C
71V416S12BEG		BEG48	CABGA	C	
71V416S12BEG8		BEG48	CABGA	C	
71V416S12BEGI		BE48	CABGA	I	
71V416S12BEI8		BE48	CABGA	I	
71V416S12PHG		PHG44	TSOP	C	
71V416S12PHG8		PHG44	TSOP	C	
71V416S12PHGI		PHG44	TSOP	I	
71V416S12PHGI8		PHG44	TSOP	I	
71V416S12YG		PBG44	SOJ	C	
71V416S12YG8		PBG44	SOJ	C	
71V416S12YGI	PBG44	SOJ	I		
71V416S12YGI8	PBG44	SOJ	I		

3624 tbl 12b

Orderable Part Information (con't)

Speed (ns)	Orderable Part ID	Pkg. Code	Pkg. Type	Temp. Grade
15	71V416L15BE	BE48	CABGA	C
	71V416L15BE8	BE48	CABGA	C
	71V416L15BEG	BEG48	CABGA	C
	71V416L15BEG8	BEG48	CABGA	C
	71V416L15BEGI	BEG48	CABGA	I
	71V416L15BEGI8	BEG48	CABGA	I
	71V416L15BEI	BE48	CABGA	I
	71V416L15BEI8	BE48	CABGA	I
	71V416L15PHG	PHG44	TSOP	C
	71V416L15PHG8	PHG44	TSOP	C
	71V416L15PHGI	PHG44	TSOP	I
	71V416L15PHGI8	PHG44	TSOP	I
	71V416L15YGI	PBG44	SOJ	I
	71V416L15YGI8	PBG44	SOJ	I

3624 tbl 12c

Speed (ns)	Orderable Part ID	Pkg. Code	Pkg. Type	Temp. Grade
15	71V416S15BE	BE48	CABGA	C
	71V416S15BE8	BE48	CABGA	C
	71V416S15BEG	BEG48	CABGA	C
	71V416S15BEG8	BEG48	CABGA	C
	71V416S15BEGI	BEG48	CABGA	I
	71V416S15BEGI8	BEG48	CABGA	I
	71V416S15BEI	BE48	CABGA	I
	71V416S15BEI8	BE48	CABGA	I
	71V416S15PHG	PHG44	TSOP	C
	71V416S15PHG8	PHG44	TSOP	C
	71V416S15PHGI	PHG44	TSOP	I
	71V416S15PHGI8	PHG44	TSOP	I
	71V416S15YG	PBG44	SOJ	C
	71V416S15YG8	PBG44	SOJ	C
	71V416S15YGI	PBG44	SOJ	I
	71V416S15YGI8	PBG44	SOJ	I

3624 tbl 12d

Datasheet Document History

08/5/99		Updated to new format
	Pg 6	Revised footnote for tcw on Write Cycle No. 1 diagram
08/31/99	Pg. 1-9	Added Industrial temperature range offering
	Pg. 9	Added Datasheet Document History
03/24/00	Pg. 6	Changed note to Write cycle No. 1 according to footnotes
08/10/00		Add 48 ball grid array package offering
	Pg. 1	Correct TTL to LVTTTL
09/11/02	Pg. 2	Updated TBD information for the 48 BGA Capacitance table
11/26/02	Pg. 8	Added "Die Revision" to ordering information
07/31/03	Pg. 8	Updated note, L10 speed grade commercial temperature only and updated die stepping from YF to Y.
10/13/03	Pg. 8	Updated ordering information. Refer to 71V416YS and 71V416YL datasheet for latest generation die step.
01/30/04	Pg. 8	Added "Restricted hazardous substance device" to ordering information
02/01/13:	Pg. 1	Removed IDT reference to fabrication
	Pg. 8	Removed die revision information from the Ordering Information
11/18/16:	Pg. 2	Updated the orderable part numbers for all pin configurations
		Added the corrected configuration title for the 48 BGA pin configuration
		Reformatted SOJ/TSOP pins & labels. No change in functionality. It remains the same
	Pg.4	Updated the Industrial values and the footnote references in the DC Electrical table
	Pg. 5	Updated the footnote references in the AC Electrical table
	Pg. 8	Updated the orderable part numbers in the Ordering Information
	Pg. 8-9	Added orderable part information tables



CORPORATE HEADQUARTERS
6024 Silver Creek Valley Road
San Jose, CA 95138

for SALES:
800-345-7015 or
408-284-8200
fax: 408-284-2775
www.idt.com

for Tech Support:
sramhelp@idt.com
408-284-4532

The IDT logo is a registered trademark of Integrated Device Technology, Inc.

Mouser Electronics

Authorized Distributor

Click to View Pricing, Inventory, Delivery & Lifecycle Information:

IDT (Integrated Device Technology):

[71V416L15YG8](#) [71V416S15BE](#) [71V416S15YG](#) [71V416S12BEI8](#) [71V416S12BEG8](#) [71V416L12BEGI](#)
[71V416L15PHG](#) [71V416L15PHGI](#) [71V416S15PHG8](#) [71V416S10BE](#) [71V416S10YG](#) [71V416S12YG](#) [71V416S12BE](#)
[71V416L12PHG8](#) [71V416S12PHGI](#) [71V416L15YGI](#) [71V416L15BEI](#) [71V416L15BEG](#) [71V416L10PHGI8](#)
[71V416S10PHGI8](#) [71V416L12YGI](#) [71V416S15YG8](#) [71V416S15BE8](#) [71V416L12PHGI8](#) [71V416S12PHGI8](#)
[71V416S12YGI8](#) [71V416L10BEG8](#) [71V416S10BE8](#) [71V416S12PHG8](#) [71V416L12PHGI](#) [71V416S15BEG](#)
[71V416S15BEI](#) [71V416S15YGI](#) [71V416L12BEI8](#) [71V416L12BEG8](#) [71V416L10YGI8](#) [71V416S15BEG8](#)
[71V416L15BEGI](#) [71V416S15BEI8](#) [71V416S10PHG8](#) [71V416L10PHGI](#) [71V416S15PHG](#) [71V416S15PHGI](#)
[71V416L15PHG8](#) [71V416L15BE8](#) [71V416L15YG](#) [71V416L15BE](#) [71V416L10BE](#) [71V416L10YG](#) [71V416L12YG](#)
[71V416S12PHG](#) [71V416L12BE](#) [71V416S12BEG](#) [71V416S12BEI](#) [71V416L10BE8](#) [71V416L12YGI8](#) [71V416L10YG8](#)
[71V416S15YGI8](#) [71V416S15BEGI8](#) [71V416L15BEGI8](#) [71V416L15YGI8](#) [71V416S12YGI](#) [71V416S10YGI8](#)
[71V416L10YGI](#) [71V416L10BEG](#) [71V416L10PHG](#) [71V416L12BE8](#) [71V416L12YG8](#) [71V416S10YG8](#)
[71V416L15BEG8](#) [71V416S15BEGI](#) [71V416L15BEI8](#) [71V416S10BEG8](#) [71V416S10PHG](#) [71V416S10YGI](#)
[71V416S12BE8](#) [71V416S10BEG](#) [71V416L12BEI](#) [71V416L12BEG](#) [71V416S10PHGI](#) [71V416L10PHG8](#)
[71V416L15PHGI8](#) [71V416S15PHGI8](#) [71V416S12YG8](#) [71V416L12BEGI8](#) [71V416L12PHG](#) [71V416YS15PHG](#)



Компания «ЭлектроПласт» предлагает заключение долгосрочных отношений при поставках импортных электронных компонентов на взаимовыгодных условиях!

Наши преимущества:

- Оперативные поставки широкого спектра электронных компонентов отечественного и импортного производства напрямую от производителей и с крупнейших мировых складов;
- Поставка более 17-ти миллионов наименований электронных компонентов;
- Поставка сложных, дефицитных, либо снятых с производства позиций;
- Оперативные сроки поставки под заказ (от 5 рабочих дней);
- Экспресс доставка в любую точку России;
- Техническая поддержка проекта, помощь в подборе аналогов, поставка прототипов;
- Система менеджмента качества сертифицирована по Международному стандарту ISO 9001;
- Лицензия ФСБ на осуществление работ с использованием сведений, составляющих государственную тайну;
- Поставка специализированных компонентов (Xilinx, Altera, Analog Devices, Intersil, Interpoint, Microsemi, Aeroflex, Peregrine, Syfer, Eurofarad, Texas Instrument, Miteq, Cobham, E2V, MA-COM, Hittite, Mini-Circuits, General Dynamics и др.);

Помимо этого, одним из направлений компании «ЭлектроПласт» является направление «Источники питания». Мы предлагаем Вам помощь Конструкторского отдела:

- Подбор оптимального решения, техническое обоснование при выборе компонента;
- Подбор аналогов;
- Консультации по применению компонента;
- Поставка образцов и прототипов;
- Техническая поддержка проекта;
- Защита от снятия компонента с производства.



Как с нами связаться

Телефон: 8 (812) 309 58 32 (многоканальный)

Факс: 8 (812) 320-02-42

Электронная почта: org@eplast1.ru

Адрес: 198099, г. Санкт-Петербург, ул. Калинина, дом 2, корпус 4, литера А.