

## FEATURES

- Throughput: 2 MSPS/1 MSPS/500 kSPS options**
- INL:  $\pm 3.2$  LSB maximum**
- Guaranteed 18-bit, no missing codes**
- Low power: 70  $\mu$ W at 10 kSPS, 14 mW at 2 MSPS (total)**
  - 9.75 mW at 2 MSPS, 4.9 mW at 1 MSPS, 2.5 mW at 500 kSPS (VDD only)
- SNR: 95 dB typical at 1 kHz,  $V_{REF} = 5$  V; 95 dB typical at 100 kHz**
- THD:  $-125$  dB typical at 1 kHz,  $V_{REF} = 5$  V;  $-108$  dB typical at 100 kHz**
- Ease of use features reduce system power and complexity**
  - Input overvoltage clamp circuit
  - Reduced nonlinear input charge kickback
  - High-Z mode
  - Long acquisition phase
  - Input span compression
  - Fast conversion time allows low SPI clock rates
  - SPI-programmable modes, read/write capability, status word
- Pseudo differential (single-ended) analog input range**
  - 0 V to  $V_{REF}$  with  $V_{REF}$  from 2.4 V to 5.1 V
- Single 1.8 V supply operation with 1.71 V to 5.5 V logic interface**
- SAR architecture: no latency/pipeline delay, valid first conversion**
- First conversion accurate**
- Guaranteed operation:  $-40^{\circ}\text{C}$  to  $+125^{\circ}\text{C}$**
- SPI/QSPI-/MICROWIRE-/DSP-compatible serial interface**
- Ability to daisy-chain multiple ADCs and busy indicator**
- 10-lead packages: 3 mm  $\times$  3 mm LFCSP, 3 mm  $\times$  4.90 mm MSOP**

## APPLICATIONS

- Automatic test equipment
- Machine automation
- Medical equipment
- Battery-powered equipment
- Precision data acquisition systems

## GENERAL DESCRIPTION

The AD4002/AD4006/AD4010 are low noise, low power, high speed, 18-bit, precision successive approximation register (SAR)

analog-to-digital converters (ADCs). The AD4002, AD4006, and AD4010 offer 2 MSPS, 1 MSPS, and 500 kSPS throughputs, respectively. They incorporate ease of use features that reduce signal chain power consumption, reduce signal chain complexity, and enable higher channel density. The high-Z mode, coupled with a long acquisition phase, eliminates the need for a dedicated high power, high speed ADC driver, thus broadening the range of low power precision amplifiers that can drive these ADCs directly while still achieving optimum performance. The input span compression feature enables the ADC driver amplifier and the ADC to operate off common supply rails without the need for a negative supply while preserving the full ADC code range. The low serial peripheral interface (SPI) clock rate requirement reduces the digital input/output power consumption, broadens processor options, and simplifies the task of sending data across digital isolation.

Operating from a 1.8 V supply, the AD4002/AD4006/AD4010 sample an analog input (IN+) from 0 V to  $V_{REF}$  with respect to a ground sense (IN-) with  $V_{REF}$  ranging from 2.4 V to 5.1 V. The AD4002 consumes only 14 mW at 2 MSPS with a minimum SCK rate of 75 MHz in turbo mode; the AD4006 consumes only 7 mW at 1 MSPS; and the AD4010 consumes only 3.5 mW at 500 kSPS. The AD4002/AD4006/AD4010 all achieve  $\pm 3.2$  LSB integral nonlinearity error (INL) maximum, no missing codes at 18 bits, and 95 dB signal-to-noise ratio (SNR) for an input frequency ( $f_{IN}$ ) of 1 kHz. The reference voltage is applied externally and can be set independently of the supply voltage.

The SPI-compatible versatile serial interface features seven different modes including the ability, using the SDI input, to daisy-chain several ADCs on a single 3-wire bus, and provides an optional busy indicator. The AD4002/AD4006/AD4010 are compatible with 1.8 V, 2.5 V, 3 V, and 5 V logic, using the separate VIO supply.

The AD4002/AD4006 are available in a 10-lead MSOP and 10-lead LFCSP, and the AD4010 is available in a 10-lead LFCSP, with operation specified from  $-40^{\circ}\text{C}$  to  $+125^{\circ}\text{C}$ . The devices are pin compatible with the 18-bit, 2 MSPS AD4003 (see Table 8).

## FUNCTIONAL BLOCK DIAGRAM

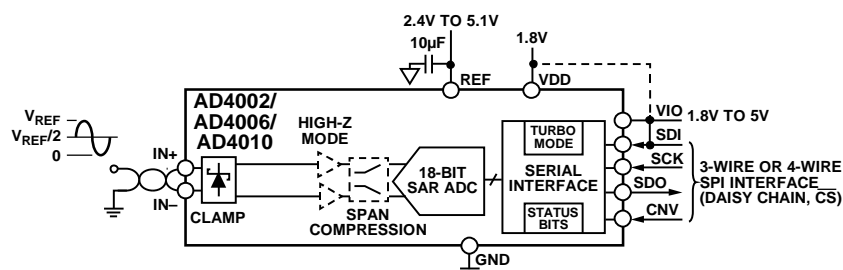

Figure 1.

Rev. 0

### Document Feedback

Information furnished by Analog Devices is believed to be accurate and reliable. However, no responsibility is assumed by Analog Devices for its use, nor for any infringements of patents or other rights of third parties that may result from its use. Specifications subject to change without notice. No license is granted by implication or otherwise under any patent or patent rights of Analog Devices. Trademarks and registered trademarks are the property of their respective owners.

## TABLE OF CONTENTS

Features .....	1	Analog Inputs.....	19
Applications.....	1	Driver Amplifier Choice .....	20
General Description .....	1	Ease of Drive Features .....	21
Functional Block Diagram .....	1	Voltage Reference Input .....	23
Revision History .....	2	Power Supply.....	23
Specifications.....	3	Digital Interface .....	24
Timing Specifications .....	6	Register Read/Write Functionality.....	24
Absolute Maximum Ratings.....	8	Status Word .....	27
Thermal Resistance .....	8	$\overline{\text{CS}}$ Mode, 3-Wire Turbo Mode.....	28
ESD Caution.....	8	$\overline{\text{CS}}$ Mode, 3-Wire Without Busy Indicator .....	29
Pin Configurations and Function Descriptions .....	9	$\overline{\text{CS}}$ Mode, 3-Wire with Busy Indicator .....	30
Typical Performance Characteristics .....	10	$\overline{\text{CS}}$ Mode, 4-Wire Turbo Mode.....	31
Terminology .....	15	$\overline{\text{CS}}$ Mode, 4-Wire Without Busy Indicator .....	32
Theory of Operation .....	16	$\overline{\text{CS}}$ Mode, 4-Wire with Busy Indicator .....	33
Circuit Information.....	16	Daisy-Chain Mode.....	34
Converter Operation.....	17	Layout Guidelines.....	35
Transfer Functions.....	17	Evaluating the AD4002/AD4006/AD4010 Performance .....	35
Applications Information .....	18	Outline Dimensions .....	36
Typical Application Diagrams .....	18	Ordering Guide .....	36

## REVISION HISTORY

1/2018—Revision 0: Initial Version

## SPECIFICATIONS

VDD = 1.71 V to 1.89 V, VIO = 1.71 V to 5.5 V, VREF = 5 V, all specifications T<sub>MIN</sub> to T<sub>MAX</sub>, high-Z mode disabled, span compression disabled, turbo mode enabled, and sampling frequency (f<sub>s</sub>) = 2 MSPS for the AD4002, f<sub>s</sub> = 1 MSPS for the AD4006, and f<sub>s</sub> = 500 kSPS for the AD4010, unless otherwise noted.

**Table 1.**

Parameter	Test Conditions/Comments	Min	Typ	Max	Unit
RESOLUTION		18			Bits
ANALOG INPUT					
Voltage Range	IN+ Voltage (V <sub>IN+</sub> ) – IN– Voltage (V <sub>IN–</sub> )	0		V <sub>REF</sub>	V
Operating Input Voltage	V <sub>IN+</sub> to GND	–0.1		V <sub>REF</sub> + 0.1	V
	V <sub>IN–</sub> to GND	–0.1		+0.1	V
	Span compression enabled	0.1 × V <sub>REF</sub>		0.9 × V <sub>REF</sub>	V
Analog Input Current	Acquisition phase, T <sub>A</sub> = 25°C		0.3		nA
	High-Z mode enabled, converting dc input at 2 MSPS		1		μA
THROUGHPUT					
Complete Cycle					
AD4002		500			ns
AD4006		1000			ns
AD4010		2000			ns
Conversion Time		270	290	320	ns
Acquisition Phase <sup>1</sup>					
AD4002		290			ns
AD4006		790			ns
AD4010		1790			ns
Throughput Rate <sup>2</sup>					
AD4002		0		2	MSPS
AD4006		0		1	MSPS
AD4010		0		500	kSPS
Transient Response <sup>3</sup>			290		ns
DC ACCURACY					
No Missing Codes		18			Bits
Integral Nonlinearity Error (INL)		–3.2	±0.8	+3.2	LSB
		–12.2	±3.1	+12.2	ppm
Differential Nonlinearity Error (DNL)		–0.8	±0.5	+0.8	LSB
Transition Noise			1.6		LSB
Zero Error		–18		+18	LSB
Zero Error Drift <sup>4</sup>		–2.2		+2.2	ppm/°C
Gain Error		–45	±10	+45	LSB
Gain Error Drift <sup>4</sup>		–2.6		+2.6	ppm/°C
Power Supply Sensitivity	VDD = 1.8 V ± 5%		2		LSB
1/f Noise <sup>5</sup>	Bandwidth = 0.1 Hz to 10 Hz		6		μV p-p
AC ACCURACY					
Dynamic Range			95.3		dB
Total RMS Noise			30.4		μV rms
f <sub>IN</sub> = 1 kHz, –0.5 dBFS, V <sub>REF</sub> = 5 V					
Signal-to-Noise Ratio (SNR)		92.5	95		dB
Spurious-Free Dynamic Range (SFDR)			122		dB
Total Harmonic Distortion (THD)			–125		dB
Signal-to-Noise-and-Distortion Ratio (SINAD)		92	95		dB
Oversampled Dynamic Range	Oversampling ratio (OSR) = 256, V <sub>REF</sub> = 5 V		119		dB

Parameter	Test Conditions/Comments	Min	Typ	Max	Unit
$f_{IN} = 1 \text{ kHz}$ , $-0.5 \text{ dBFS}$ , $V_{REF} = 2.5 \text{ V}$					
SNR		87	89		dB
SFDR			122		dB
THD			-123.5		dB
SINAD		87	89		dB
$f_{IN} = 100 \text{ kHz}$ , $-0.5 \text{ dBFS}$ , $V_{REF} = 5 \text{ V}$					
SNR			95		dB
THD			-108		dB
SINAD			94.8		dB
$f_{IN} = 400 \text{ kHz}$ , $-0.5 \text{ dBFS}$ , $V_{REF} = 5 \text{ V}$					
SNR			94		dB
THD			-92		dB
SINAD			90		dB
-3 dB Input Bandwidth			10		MHz
Aperture Delay			1		ns
Aperture Jitter			1		ps rms
REFERENCE					
Voltage Range, $V_{REF}$		2.4		5.1	V
Current	$V_{REF} = 5 \text{ V}$				
AD4002	2 MSPS		0.75		mA
AD4006	1 MSPS		0.375		mA
AD4010	500 kSPS		0.19		mA
INPUT OVERVOLTAGE CLAMP					
$I_{IN+}/I_{IN-}$ Current, $I_{IN+}/I_{IN-}$	$V_{REF} = 5 \text{ V}$			50	mA
	$V_{REF} = 2.5 \text{ V}$			50	mA
$V_{IN+}/V_{IN-}$ at Maximum $I_{IN+}/I_{IN-}$	$V_{REF} = 5 \text{ V}$		5.4		V
	$V_{REF} = 2.5 \text{ V}$		3.1		V
$V_{IN+}/V_{IN-}$ Clamp On/Off Threshold	$V_{REF} = 5 \text{ V}$	5.25	5.4		V
	$V_{REF} = 2.5 \text{ V}$	2.68	2.8		V
Deactivation Time			360		ns
REF Current at Maximum $I_{IN+}$	$V_{IN+} > V_{REF}$		100		$\mu\text{A}$
DIGITAL INPUTS					
Logic Levels					
Input Low Voltage, $V_{IL}$	$V_{IO} > 2.7 \text{ V}$	-0.3		$+0.3 \times V_{IO}$	V
	$V_{IO} \leq 2.7 \text{ V}$	-0.3		$+0.2 \times V_{IO}$	V
Input High Voltage, $V_{IH}$	$V_{IO} > 2.7 \text{ V}$	$0.7 \times V_{IO}$		$V_{IO} + 0.3$	V
	$V_{IO} \leq 2.7 \text{ V}$	$0.8 \times V_{IO}$		$V_{IO} + 0.3$	V
Input Low Current, $I_{IL}$		-1		+1	$\mu\text{A}$
Input High Current, $I_{IH}$		-1		+1	$\mu\text{A}$
Input Pin Capacitance			6		pF
DIGITAL OUTPUTS					
Data Format		Serial 18 bits, straight binary			
Pipeline Delay		Conversion results available immediately after completed conversion			
Output Low Voltage, $V_{OL}$	$I_{SINK} = 500 \mu\text{A}$			0.4	V
Output High Voltage, $V_{OH}$	$I_{SOURCE} = -500 \mu\text{A}$	$V_{IO} - 0.3$			V

Parameter	Test Conditions/Comments	Min	Typ	Max	Unit
<b>POWER SUPPLIES</b>					
VDD		1.71	1.8	1.89	V
VIO		1.71		5.5	V
Standby Current	VDD and VIO = 1.8 V, T <sub>A</sub> = 25°C		1.6		μA
Power Dissipation	VDD = 1.8 V, VIO = 1.8 V, V <sub>REF</sub> = 5 V				
	10 kSPS, high-Z mode disabled		70		μW
	500 kSPS, high-Z mode disabled		3.5	4.4	mW
	1 MSPS, high-Z mode disabled		7	8.4	mW
	2 MSPS, high-Z mode disabled		14	16.5	mW
	500 kSPS, high-Z mode enabled		3.8	5.4	mW
	1 MSPS, high-Z mode enabled		7.6	10.8	mW
	2 MSPS, high-Z mode enabled		15.2	21.5	mW
VDD Only	500 kSPS, high-Z mode disabled		2.5		mW
	1 MSPS, high-Z mode disabled		4.9		mW
	2 MSPS, high-Z mode disabled		9.75		mW
REF Only	500 kSPS, high-Z mode disabled		0.95		mW
	1 MSPS, high-Z mode disabled		1.9		mW
	2 MSPS, high-Z mode disabled		3.65		mW
VIO Only	500 kSPS, high-Z mode disabled		0.1		mW
	1 MSPS, high-Z mode disabled		0.2		mW
	2 MSPS, high-Z mode disabled		0.6		mW
Energy per Conversion			7		nJ/sample
<b>TEMPERATURE RANGE</b>					
Specified Performance	T <sub>MIN</sub> to T <sub>MAX</sub>	-40		+125	°C

<sup>1</sup> The acquisition phase is the time available for the input sampling capacitors to acquire a new input with the ADC running at a throughput rate of 2 MSPS for the AD4002, 1 MSPS for the AD4006, and 500 kSPS for the AD4010.

<sup>2</sup> A throughput rate of 2 MSPS can only be achieved with turbo mode enabled and a minimum SCK rate of 75 MHz. Refer to Table 4 for the maximum achievable throughput for different modes of operation.

<sup>3</sup> Transient response is the time required for the ADC to acquire a full-scale input step to ±2 LSB accuracy. See Figure 39 for more information on ADC input settling for multiplexed applications.

<sup>4</sup> The minimum and maximum values are guaranteed by characterization, but not production tested.

<sup>5</sup> See the 1/f noise plot in Figure 23.

## TIMING SPECIFICATIONS

VDD = 1.71 V to 1.89 V, VIO = 1.71 V to 5.5 V, VREF = 5 V, all specifications T<sub>MIN</sub> to T<sub>MAX</sub>, high-Z mode disabled, span compression disabled, turbo mode enabled, and f<sub>s</sub> = 2 MSPS for the AD4002, f<sub>s</sub> = 1 MSPS for the AD4006, and f<sub>s</sub> = 500 kSPS for the AD4010, unless otherwise noted. See Figure 2 for the timing voltage levels.

Table 2. Digital Interface Timing

Parameter	Symbol	Min	Typ	Max	Unit
CONVERSION TIME—CNV RISING EDGE TO DATA AVAILABLE	t <sub>CONV</sub>	270	290	320	ns
ACQUISITION PHASE <sup>1</sup>	t <sub>ACQ</sub>				
AD4002		290			ns
AD4006		790			ns
AD4010		1790			ns
TIME BETWEEN CONVERSIONS	t <sub>CYC</sub>				
AD4002		500			ns
AD4006		1000			ns
AD4010		2000			ns
CNV PULSE WIDTH (CS MODE) <sup>2</sup>	t <sub>CNVH</sub>	10			ns
SCK PERIOD (CS MODE) <sup>3</sup>	t <sub>SCK</sub>				
VIO > 2.7 V		9.8			ns
VIO > 1.7 V		12.3			ns
SCK PERIOD (DAISY-CHAIN MODE) <sup>4</sup>	t <sub>SCK</sub>				
VIO > 2.7 V		20			ns
VIO > 1.7 V		25			ns
SCK LOW TIME	t <sub>SCKL</sub>	3			ns
SCK HIGH TIME	t <sub>SCKH</sub>	3			ns
SCK FALLING EDGE TO DATA REMAINS VALID DELAY	t <sub>HSDO</sub>	1.5			ns
SCK FALLING EDGE TO DATA VALID DELAY	t <sub>DSO</sub>			7.5	ns
VIO > 1.7 V				10.5	ns
CNV OR SDI LOW TO SDO D17 MOST SIGNIFICANT BIT (MSB) VALID DELAY (CS MODE)	t <sub>EN</sub>			10	ns
VIO > 1.7 V				13	ns
CNV RISING EDGE TO FIRST SCK RISING EDGE DELAY	t <sub>QUIET1</sub>	190			ns
LAST SCK FALLING EDGE TO CNV RISING EDGE DELAY <sup>5</sup>	t <sub>QUIET2</sub>	60			ns
CNV OR SDI HIGH OR LAST SCK FALLING EDGE TO SDO HIGH IMPEDANCE (CS MODE)	t <sub>DIS</sub>			20	ns
SDI VALID SETUP TIME FROM CNV RISING EDGE	t <sub>SSDICNV</sub>	2			ns
SDI VALID HOLD TIME FROM CNV RISING EDGE (CS MODE)	t <sub>HSDICNV</sub>	2			ns
SCK VALID HOLD TIME FROM CNV RISING EDGE (DAISY-CHAIN MODE)	t <sub>HSCKCNV</sub>	12			ns
SDI VALID SETUP TIME FROM SCK RISING EDGE (DAISY-CHAIN MODE)	t <sub>SSDISCK</sub>	2			ns
SDI VALID HOLD TIME FROM SCK RISING EDGE (DAISY-CHAIN MODE)	t <sub>HSDISCK</sub>	2			ns

<sup>1</sup> The acquisition phase is the time available for the input sampling capacitors to acquire a new input with the ADC running at a throughput rate of 2 MSPS for the AD4002, 1 MSPS for the AD4006, and 500 kSPS for the AD4010.

<sup>2</sup> For turbo mode, t<sub>CNVH</sub> must match the t<sub>QUIET1</sub> minimum.

<sup>3</sup> A throughput rate of 2 MSPS can only be achieved with turbo mode enabled and a minimum SCK rate of 75 MHz. Refer to Table 4 for the maximum achievable throughput for different modes of operation.

<sup>4</sup> A 50% duty cycle is assumed for SCK.

<sup>5</sup> See Figure 22 for SINAD vs. t<sub>QUIET2</sub>.

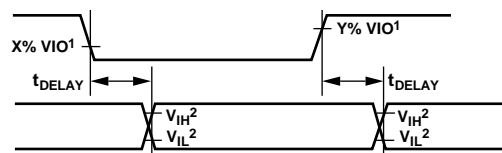

<sup>1</sup>FOR VIO ≤ 2.7V, X = 80, AND Y = 20; FOR VIO > 2.7V, X = 70, AND Y = 30.

<sup>2</sup>MINIMUM V<sub>IH</sub> AND MAXIMUM V<sub>IL</sub> USED. SEE DIGITAL INPUTS SPECIFICATIONS IN TABLE 1.

Figure 2. Voltage Levels for Timing

Table 3. Register Read/Write Timing

Parameter	Symbol	Min	Typ	Max	Unit
READ/WRITE OPERATION					
CNV Pulse Width <sup>1</sup>	$t_{CNVH}$	10			ns
SCK Period	$t_{SCK}$				
VIO > 2.7 V		9.8			ns
VIO > 1.7 V		12.3			ns
SCK Low Time	$t_{SCKL}$	3			ns
SCK High Time	$t_{SCKH}$	3			ns
READ OPERATION					
CNV Low to SDO D17 MSB Valid Delay	$t_{EN}$				
VIO > 2.7 V				10	ns
VIO > 1.7 V				13	ns
SCK Falling Edge to Data Remains Valid	$t_{HSDO}$	1.5			ns
SCK Falling Edge to Data Valid Delay	$t_{DSDO}$				
VIO > 2.7 V				7.5	ns
VIO > 1.7 V				10.5	ns
CNV Rising Edge to SDO High Impedance	$t_{DIS}$			20	ns
WRITE OPERATION					
SDI Valid Setup Time from SCK Rising Edge	$t_{SSDISCK}$	2			ns
SDI Valid Hold Time from SCK Rising Edge	$t_{HSDISCK}$	2			ns
CNV Rising Edge to SCK Edge Hold Time	$t_{HCNVSCK}$	0			ns
CNV Falling Edge to SCK Active Edge Setup Time	$t_{SCNVSCK}$	6			ns

<sup>1</sup> For turbo mode,  $t_{CNVH}$  must match the  $t_{QUIET1}$  minimum.

Table 4. Achievable Throughput for Different Modes of Operation

Parameter	Test Conditions/Comments	Min	Typ	Max	Unit
THROUGHPUT, CS MODE					
3-Wire and 4-Wire Turbo Mode	$f_{SCK} = 100 \text{ MHz}, VIO \geq 2.7 \text{ V}$			2	MSPS
	$f_{SCK} = 80 \text{ MHz}, VIO < 2.7 \text{ V}$			2	MSPS
3-Wire and 4-Wire Turbo Mode and Six Status Bits	$f_{SCK} = 100 \text{ MHz}, VIO \geq 2.7 \text{ V}$			2	MSPS
	$f_{SCK} = 80 \text{ MHz}, VIO < 2.7 \text{ V}$			1.78	MSPS
3-Wire and 4-Wire Mode	$f_{SCK} = 100 \text{ MHz}, VIO \geq 2.7 \text{ V}$			1.75	MSPS
	$f_{SCK} = 80 \text{ MHz}, VIO < 2.7 \text{ V}$			1.62	MSPS
3-Wire and 4-Wire Mode and Six Status Bits	$f_{SCK} = 100 \text{ MHz}, VIO \geq 2.7 \text{ V}$			1.59	MSPS
	$f_{SCK} = 80 \text{ MHz}, VIO < 2.7 \text{ V}$			1.44	MSPS

## ABSOLUTE MAXIMUM RATINGS

Note that the input overvoltage clamp cannot sustain the overvoltage condition for an indefinite amount of time.

Table 5.

Parameter	Rating
Analog Inputs IN+, IN– to GND <sup>1</sup>	–0.3 V to $V_{REF} + 0.4$ V or $\pm 130$ mA <sup>2</sup>
Supply Voltage REF, VIO to GND	–0.3 V to +6.0 V
VDD to GND	–0.3 V to +2.1 V
VDD to VIO	–6 V to +2.4 V
Digital Inputs to GND	–0.3 V to VIO + 0.3 V
Digital Outputs to GND	–0.3 V to VIO + 0.3 V
Storage Temperature Range	–65°C to +150°C
Junction Temperature	150°C
Lead Temperature Soldering	260°C reflow as per JEDEC J-STD-020
Electrostatic Discharge (ESD) Ratings	
Human Body Model	4 kV
Machine Model	200 V
Field Induced Charged Device Model	1.25 kV

<sup>1</sup> See the Analog Inputs section for an explanation of IN+ and IN–.

<sup>2</sup> Current condition tested over a 10 ms time interval.

Stresses at or above those listed under Absolute Maximum Ratings may cause permanent damage to the product. This is a stress rating only; functional operation of the product at these or any other conditions above those indicated in the operational section of this specification is not implied. Operation beyond the maximum operating conditions for extended periods may affect product reliability.

## THERMAL RESISTANCE

Thermal performance is directly linked to printed circuit board (PCB) design and operating environment. Careful attention to PCB thermal design is required.

Table 6. Thermal Resistance

Package Type <sup>1</sup>	$\theta_{JA}$ <sup>2</sup>	$\theta_{JC}$ <sup>3</sup>	Unit
RM-10	147	38	°C/W
CP-10-9	114	33	°C/W

<sup>1</sup> Test Condition 1: thermal impedance simulated values are based upon use of a 2S2P JEDEC PCB. See the Ordering Guide.

<sup>2</sup>  $\theta_{JA}$  is the natural convection junction to ambient thermal resistance measured in a one cubic foot sealed enclosure.

<sup>3</sup>  $\theta_{JC}$  is the junction to case thermal resistance.

## ESD CAUTION



**ESD (electrostatic discharge) sensitive device.** Charged devices and circuit boards can discharge without detection. Although this product features patented or proprietary protection circuitry, damage may occur on devices subjected to high energy ESD. Therefore, proper ESD precautions should be taken to avoid performance degradation or loss of functionality.



## PIN CONFIGURATIONS AND FUNCTION DESCRIPTIONS

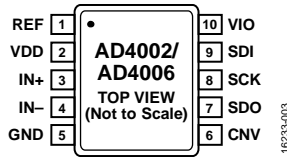
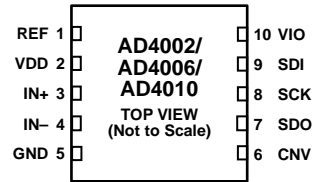

Figure 3. 10-Lead MSOP Pin Configuration



NOTES  
1. CONNECT THE EXPOSED PAD TO GND. THIS CONNECTION IS NOT REQUIRED TO MEET THE SPECIFIED PERFORMANCE.

Figure 4. 10-Lead LFCSP Pin Configuration

Table 7. Pin Function Descriptions

Pin No.	Mnemonic	Type <sup>1</sup>	Description
1	REF	AI	Reference Input Voltage. The $V_{REF}$ range is 2.4 V to 5.1 V. This pin is referred to the GND pin and must be decoupled closely to the GND pin with a 10 $\mu$ F, X7R ceramic capacitor.
2	VDD	P	1.8 V Power Supply. The VDD range is 1.71 V to 1.89 V. Bypass VDD to GND with a 0.1 $\mu$ F ceramic capacitor.
3	IN+	AI	Analog Input. This pin is referred to the analog ground sense pin (IN-). The device samples the voltage differential between IN+ and IN- on the leading edge on CNV. The operating input range of (IN+) - (IN-) is 0 V to $V_{REF}$ .
4	IN-	AI	Analog Input Ground Sense. Connect this pin to the analog ground plane or to a remote sense ground.
5	GND	P	Power Supply Ground.
6	CNV	DI	Convert Input. This input has multiple functions. On its leading edge, it initiates the conversions and selects the interface mode of the device: daisy-chain mode or $\overline{CS}$ mode. In $\overline{CS}$ mode, the SDO pin is enabled when CNV is low. In daisy-chain mode, the data is read when CNV is high.
7	SDO	DO	Serial Data Output. The conversion result is output on this pin. It is synchronized to SCK.
8	SCK	DI	Serial Data Clock Input. When the device is selected, the conversion result is shifted out by this clock.
9	SDI	DI	Serial Data Input. This input provides multiple features. It selects the interface mode of the ADC as follows: Daisy-chain mode is selected if SDI is low during the CNV rising edge. In this mode, SDI is used as a data input to daisy-chain the conversion results of two or more ADCs onto a single SDO line. The digital data level on SDI is output on SDO with a delay of 18 SCK cycles. $\overline{CS}$ mode is selected if SDI is high during the CNV rising edge. In this mode, either SDI or CNV can enable the serial output signals when low. If SDI or CNV is low when the conversion is complete, the busy indicator feature is enabled. With CNV low, the device can be programmed by clocking in a 18-bit word on SDI on the rising edge of SCK.
10	VIO	P	Input/Output Interface Digital Power. Nominally, this pin is at the same supply as the host interface (1.8 V, 2.5 V, 3 V, or 5 V). Bypass VIO to GND with a 0.1 $\mu$ F ceramic capacitor.
N/A <sup>2</sup>	EPAD	P	Exposed Pad (LFCSP Only). Connect the exposed pad to GND. This connection is not required to meet the specified performance.

<sup>1</sup> AI is analog input, P is power, DI is digital input, and DO is digital output.

<sup>2</sup> N/A means not applicable.

### TYPICAL PERFORMANCE CHARACTERISTICS

VDD = 1.8 V; VIO = 3.3 V; VREF = 5 V; TA = 25°C, high-Z mode disabled, span compression disabled, turbo mode enabled, and fs = 2 MSPS for the AD4002, fs = 1 MSPS for the AD4006, and fs = 500 kSPS for the AD4010, unless otherwise noted.

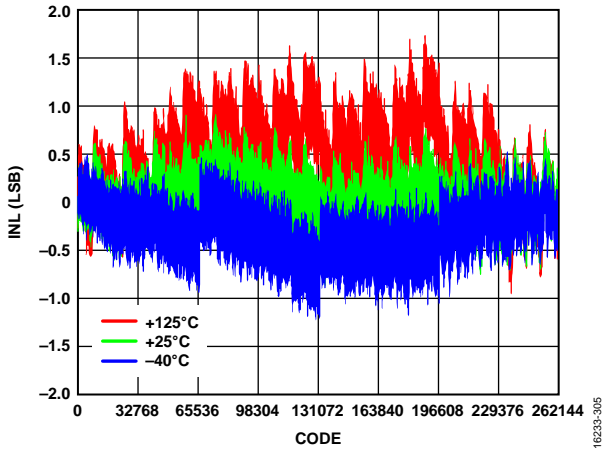

Figure 5. INL vs. Code for Various Temperatures, VREF = 5 V

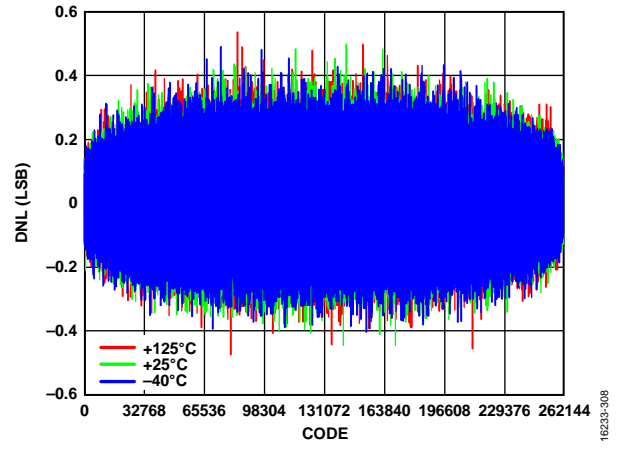

Figure 8. DNL vs. Code for Various Temperatures, VREF = 5 V

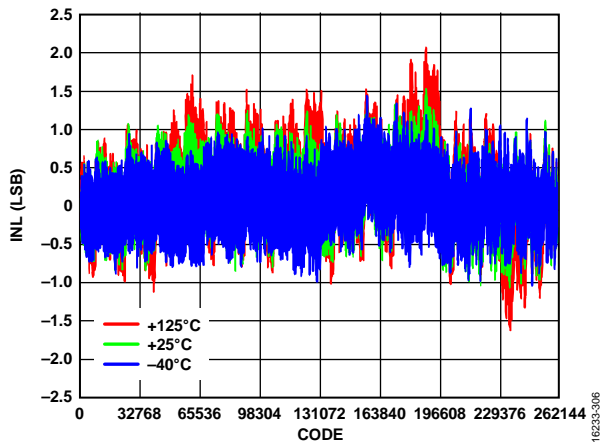

Figure 6. INL vs. Code for Various Temperatures, VREF = 2.5 V

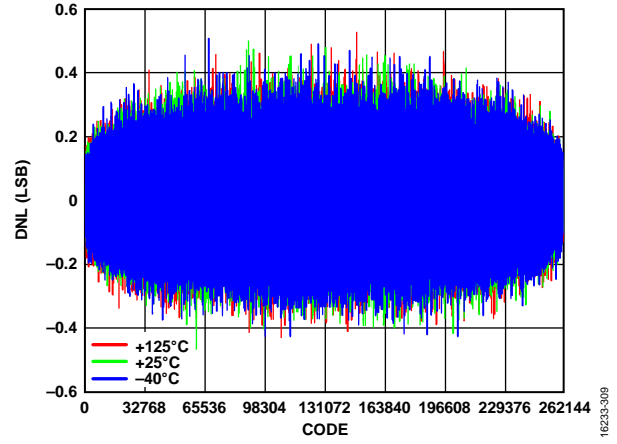

Figure 9. DNL vs. Code for Various Temperatures, VREF = 2.5 V

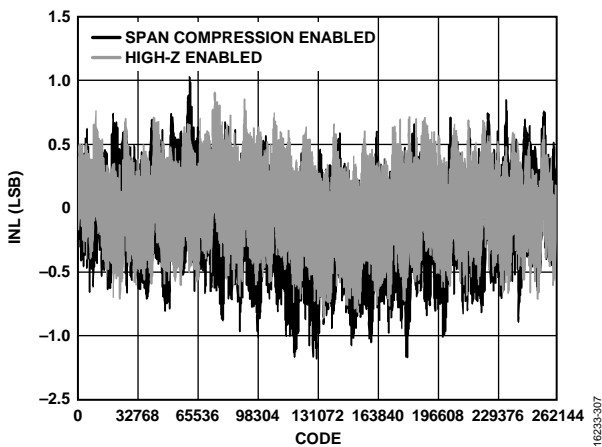

Figure 7. INL vs. Code, High-Z and Span Compression Modes Enabled, VREF = 5 V

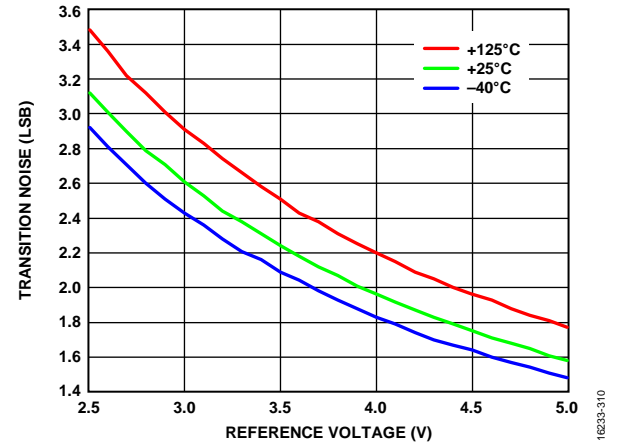

Figure 10. Transition Noise vs. Reference Voltage for Various Temperatures

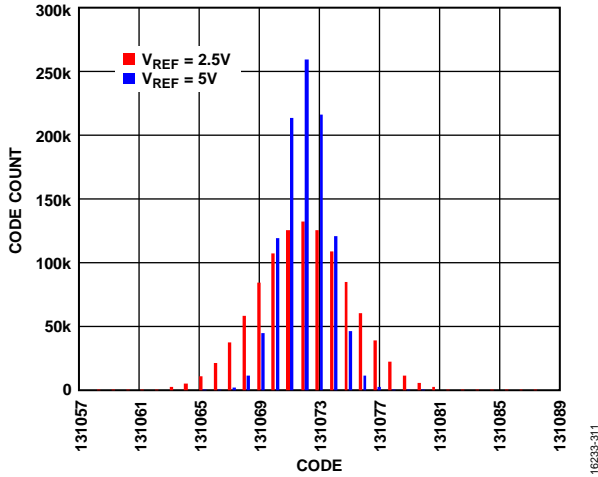

Figure 11. Histogram of a DC Input at Code Center,  $V_{REF} = 2.5V$  and  $V_{REF} = 5V$

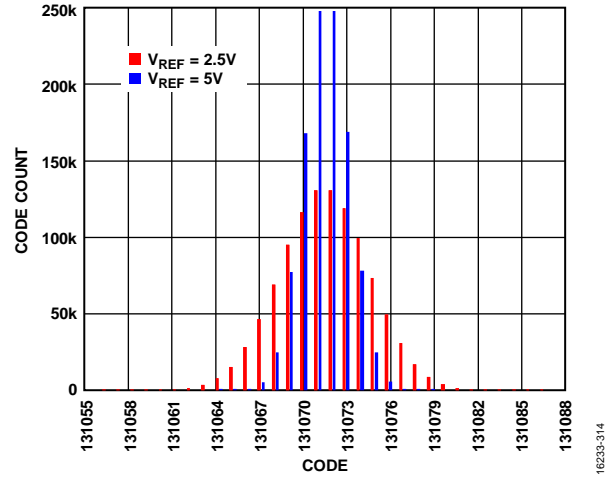

Figure 14. Histogram of a DC Input at Code Transition,  $V_{REF} = 2.5V$  and  $V_{REF} = 5V$

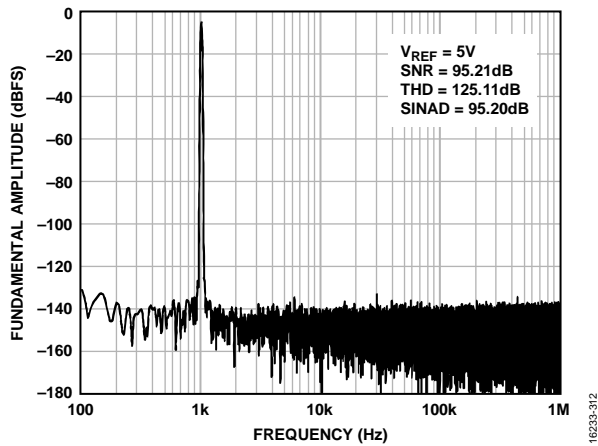

Figure 12. 1 kHz, -0.5 dBFS Input Tone Fast Fourier Transform (FFT), Wide View,  $V_{REF} = 5V$

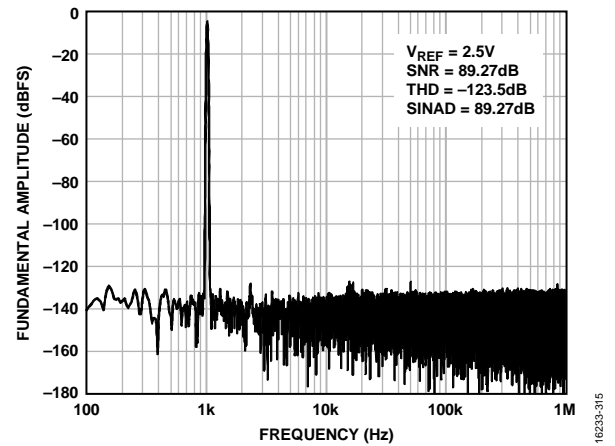

Figure 15. 1 kHz, -0.5 dBFS Input Tone FFT, Wide View,  $V_{REF} = 2.5V$

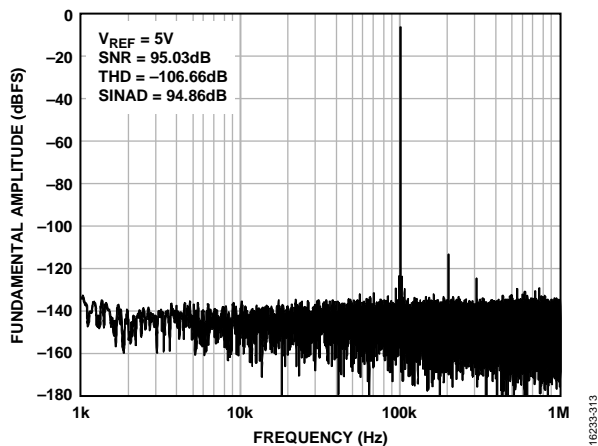

Figure 13. 100 kHz, -0.5 dBFS Input Tone FFT, Wide View

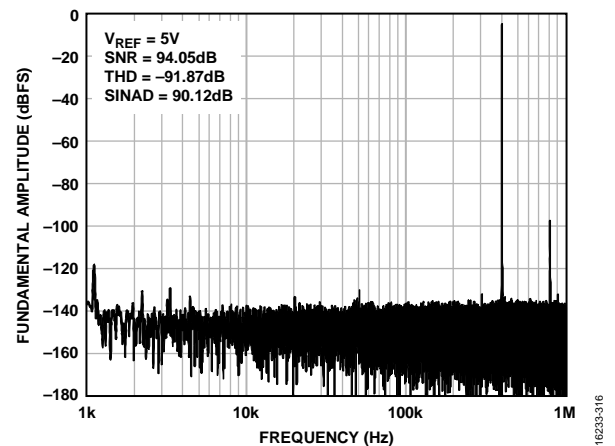

Figure 16. 400 kHz, -0.5 dBFS Input Tone FFT, Wide View

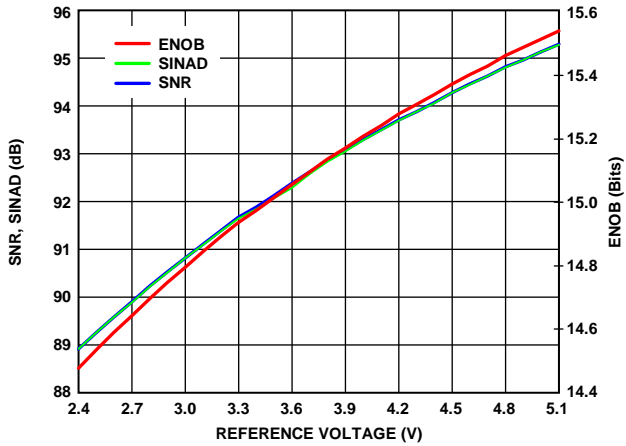

Figure 17. SNR, SINAD, and Effective Number of Bits (ENOB) vs. Reference Voltage,  $f_{IN} = 1 \text{ kHz}$

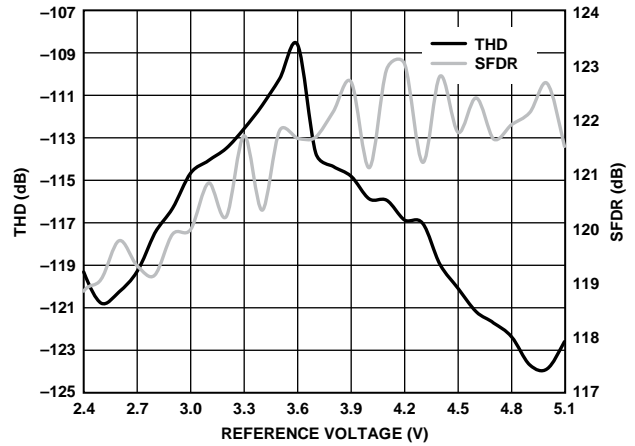

Figure 20. THD and SFDR vs. Reference Voltage,  $f_{IN} = 1 \text{ kHz}$

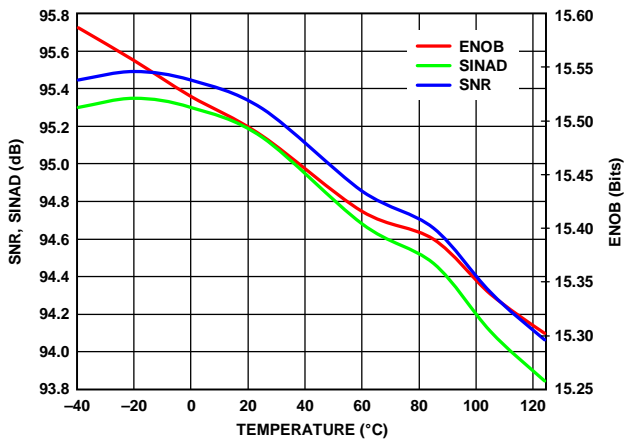

Figure 18. SNR, SINAD, and ENOB vs. Temperature,  $f_{IN} = 1 \text{ kHz}$

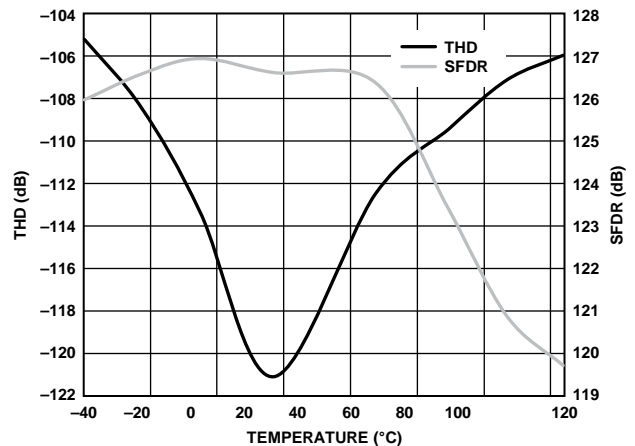

Figure 21. THD and SFDR vs. Temperature,  $f_{IN} = 1 \text{ kHz}$

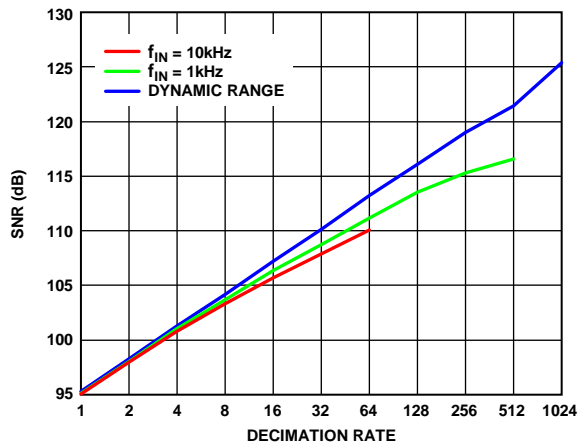

Figure 19. SNR vs. Decimation Rate for Various Input Frequencies, 2 MSPS

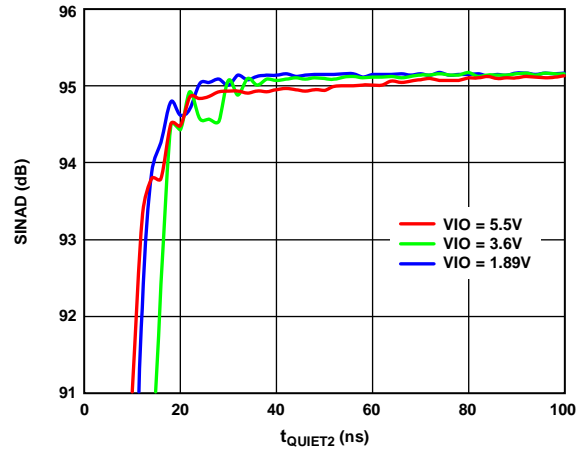

Figure 22. SINAD vs.  $t_{QUIET2}$

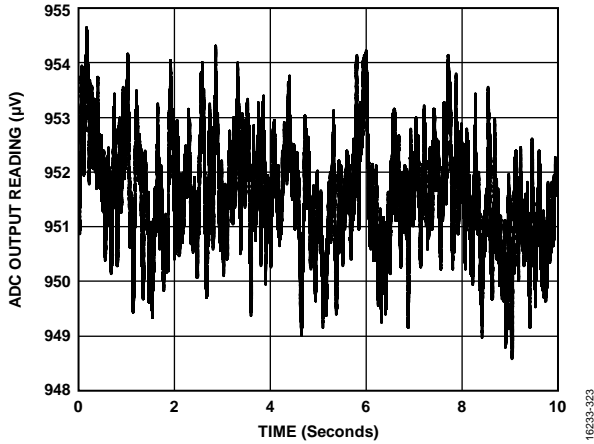

Figure 23. 1/f Noise for 0.1 Hz to 10 Hz Bandwidth, 50 kSPS, 2500 Samples Averaged per Reading

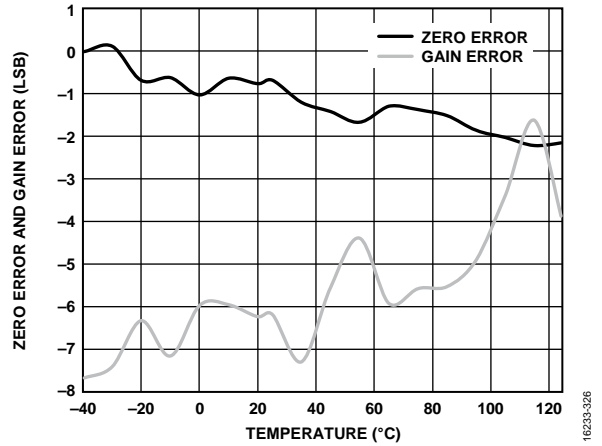

Figure 26. Zero Error and Gain Error vs. Temperature

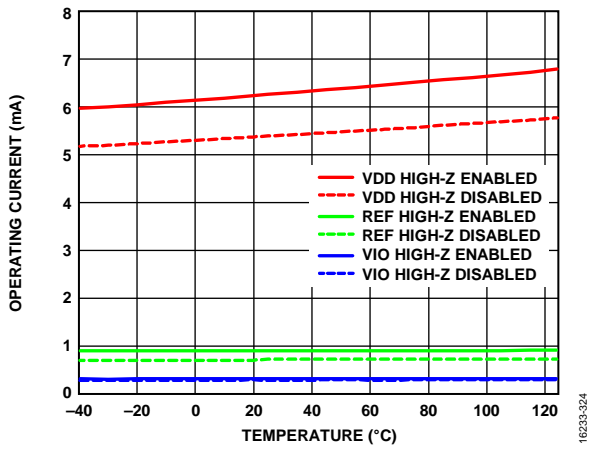

Figure 24. Operating Current vs. Temperature, AD4002, 2 MSPS

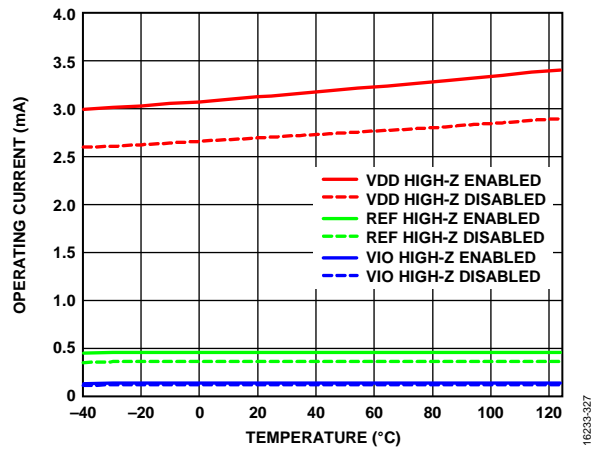

Figure 27. Operating Current vs. Temperature, AD4006, 1 MSPS

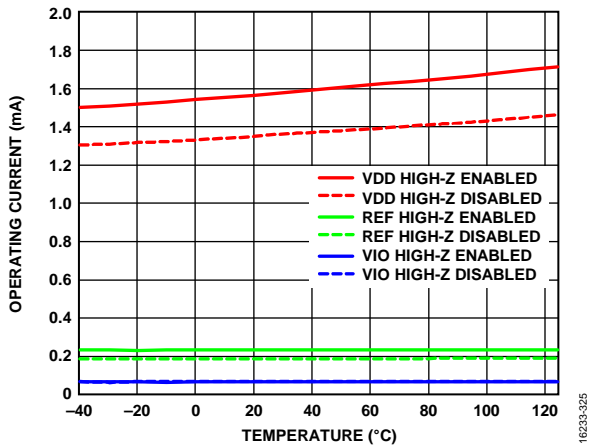

Figure 25. Operating Current vs. Temperature, AD4010, 500 kSPS

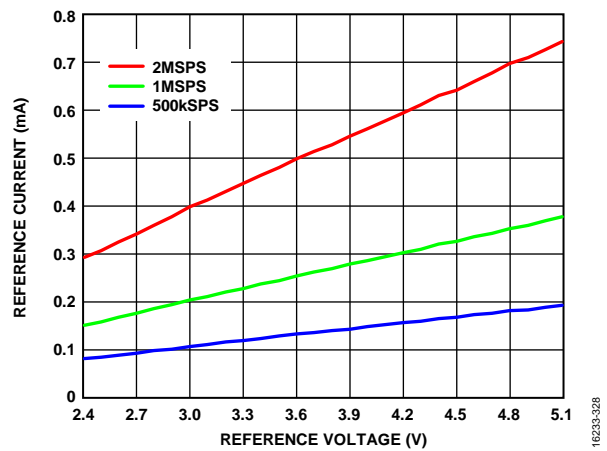

Figure 28. Reference Current vs. Reference Voltage

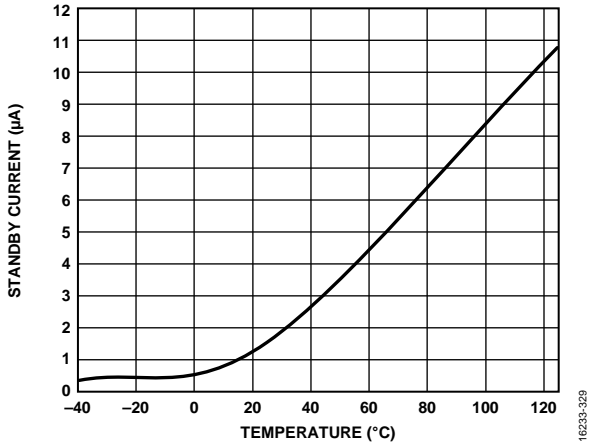

Figure 29. Standby Current vs. Temperature

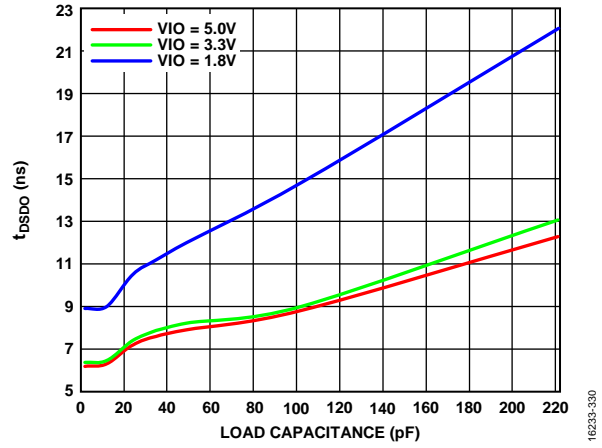

Figure 30. t<sub>DSDO</sub> vs. Load Capacitance

## TERMINOLOGY

### Integral Nonlinearity Error (INL)

INL is the deviation of each individual code from a line drawn from negative full scale through positive full scale. The point used as negative full scale occurs  $\frac{1}{2}$  LSB before the first code transition. Positive full scale is defined as a level  $1\frac{1}{2}$  LSB beyond the last code transition. The deviation is measured from the middle of each code to the true straight line (see Figure 32).

### Differential Nonlinearity Error (DNL)

In an ideal ADC, code transitions are 1 LSB apart. DNL is the maximum deviation from this ideal value. It is often specified in terms of resolution for which no missing codes are guaranteed.

### Zero Error

Zero error is the difference between the ideal voltage that results in the first code transition ( $\frac{1}{2}$  LSB above analog ground) and the actual voltage producing that code.

### Gain Error

The first transition (from 100 ... 00 to 100 ... 01) occurs at a level  $\frac{1}{2}$  LSB above nominal negative full scale ( $-4.999981$  V for the  $\pm 5$  V range). The last transition (from 011 ... 10 to 011 ... 11) occurs for an analog voltage  $1\frac{1}{2}$  LSB below the nominal full scale ( $+4.999943$  V for the  $\pm 5$  V range). The gain error is the deviation of the difference between the actual level of the last transition and the actual level of the first transition from the difference between the ideal levels.

### Spurious-Free Dynamic Range (SFDR)

SFDR is the difference, in decibels (dB), between the root mean square (rms) amplitude of the input signal and the peak spurious signal.

### Effective Number of Bits (ENOB)

ENOB is a measurement of the resolution with a sine wave input. It is related to SINAD as follows:

$$ENOB = (SINAD_{dB} - 1.76)/6.02$$

ENOB is expressed in bits.

### Total Harmonic Distortion (THD)

THD is the ratio of the rms sum of the first five harmonic components to the rms value of a full-scale input signal and is expressed in decibels.

### Dynamic Range

Dynamic range is the ratio of the rms value of the full scale to the total rms noise measured. The value for dynamic range is expressed in decibels. It is measured with a signal at  $-60$  dBFS so that it includes all noise sources and DNL artifacts.

### Signal-to-Noise Ratio (SNR)

SNR is the ratio of the rms value of the actual input signal to the rms sum of all other spectral components below the Nyquist frequency, excluding harmonics and dc. The value for SNR is expressed in decibels.

### Signal-to-Noise-and-Distortion Ratio (SINAD)

SINAD is the ratio of the rms value of the actual input signal to the rms sum of all other spectral components that are less than the Nyquist frequency, including harmonics but excluding dc. The value of SINAD is expressed in decibels.

### Aperture Delay

Aperture delay is the measure of the acquisition performance and is the time between the rising edge of the CNV input and when the input signal is held for a conversion.

### Transient Response

Transient response is the time required for the ADC to acquire a full-scale input step to  $\pm 0.5$  LSB accuracy.

### Power Supply Rejection Ratio (PSRR)

PSRR is the ratio of the power in the ADC output at the frequency,  $f$ , to the power of a 200 mV p-p sine wave applied to the ADC VDD supply of frequency,  $f$ .

$$PSRR \text{ (dB)} = 10 \log(P_{VDD\_IN}/P_{ADC\_OUT})$$

where:

$P_{VDD\_IN}$  is the power at the frequency,  $f$ , at the VDD pin.

$P_{ADC\_OUT}$  is the power at the frequency,  $f$ , in the ADC output.

## THEORY OF OPERATION

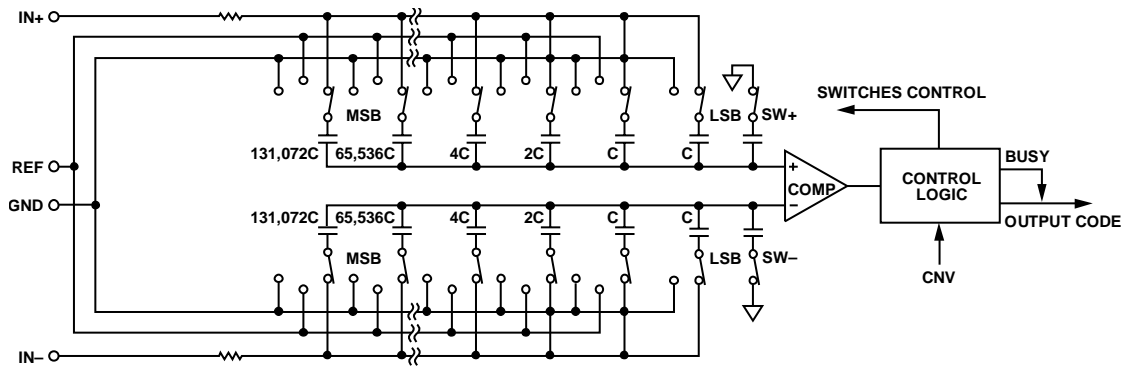

Figure 31. ADC Simplified Schematic

### CIRCUIT INFORMATION

The AD4002/AD4006/AD4010 are high speed, low power, single-supply, precise, 18-bit pseudo differential ADCs based on a SAR architecture.

The AD4002 is capable of converting 2,000,000 samples per second (2 MSPS), the AD4006 is capable of converting 1,000,000 samples per second (1 MSPS), and the AD4010 is capable of converting 500,000 samples per second (500 kSPS). The power consumption of the AD4002/AD4006/AD4010 scales with throughput because the devices power down in between conversions. When operating at 10 kSPS, for example, they typically consume 70  $\mu$ W, making them ideal for battery-powered applications. The AD4002/AD4006/AD4010 also have a valid first conversion after being powered down for long periods, which can further reduce power consumed in applications in which the ADC does not need to be constantly converting.

The AD4002/AD4006/AD4010 provide the user with an on-chip track-and-hold and do not exhibit any pipeline delay or latency, making them ideal for multiplexed applications.

The AD4002/AD4006/AD4010 incorporate a multitude of unique ease of use features that result in a lower system power and footprint.

The AD4002/AD4006/AD4010 each have an internal voltage clamp that protects the device from overvoltage damage on the analog inputs.

The analog input incorporates circuitry that reduces the nonlinear charge kickback seen from a typical switched capacitor SAR input. This reduction in kickback, combined with a longer acquisition phase, means reduced settling requirements on the driving amplifier. This combination allows the use of lower bandwidth and lower power amplifiers as drivers. It has the additional benefit of allowing a larger resistor value in the input RC filter and a corresponding smaller capacitor, which results in a smaller RC load for the amplifier, improving stability and power dissipation.

High-Z mode can be enabled via the SPI interface by programming a register bit (see Table 14). When high-Z mode is enabled, the ADC input has a low input charging current at low input signal frequencies as well as improved distortion over a wide

frequency range up to 100 kHz. For frequencies greater than 100 kHz and multiplexing, disable high-Z mode.

For single-supply applications, a span compression feature creates additional headroom and footroom for the driving amplifier to access the full range of the ADC.

The fast conversion time of the AD4002/AD4006/AD4010, along with turbo mode, allows low clock rates to read back conversions, even when running at their respective maximum throughput rates. Note that, for the AD4002, the full throughput rate of 2 MSPS can be achieved only with turbo mode enabled.

The AD4002/AD4006/AD4010 can interface with any 1.8 V to 5 V digital logic family. They are available in a 10-lead MSOP or a tiny 10-lead LFCSP that allows space savings and flexible configurations.

The AD4002/AD4006/AD4010 are pin for pin compatible with some of the 14-/16-/18-/20-bit precision SAR ADCs listed in Table 8.

Table 8. MSOP, LFCSP 14-/16-/18-/20-Bit Precision SAR ADCs

Bits	100 kSPS	250 kSPS	400 kSPS to 500 kSPS	$\geq 1000$ kSPS
20 <sup>1</sup>				AD4020 <sup>2</sup>
18 <sup>1</sup>	AD7989-1 <sup>2</sup>	AD7691 <sup>2</sup>	AD4011 <sup>2</sup> , AD7690 <sup>2</sup> , AD7989-5 <sup>2</sup>	AD4003 <sup>2</sup> , AD4007 <sup>2</sup> , AD7982 <sup>2</sup> , AD7984 <sup>2</sup>
18 <sup>3</sup>			AD4010 <sup>2</sup>	AD4002 <sup>2</sup> , AD4006 <sup>2</sup>
16 <sup>1</sup>	AD7684	AD7687 <sup>2</sup>	AD7688 <sup>2</sup> , AD7693 <sup>2</sup> , AD7916 <sup>2</sup>	AD4001 <sup>2</sup> , AD4005 <sup>2</sup> , AD7915 <sup>2</sup>
16 <sup>3</sup>	AD7680, AD7683, AD7988-1 <sup>2</sup>	AD7685 <sup>2</sup> , AD7694	AD7686 <sup>2</sup> , AD7988-5 <sup>2</sup> , AD4008 <sup>2</sup>	AD4000 <sup>2</sup> , AD4004 <sup>2</sup> , AD7980 <sup>2</sup> , AD7983 <sup>2</sup>
14 <sup>3</sup>	AD7940	AD7942 <sup>2</sup>	AD7946 <sup>2</sup>	Not applicable

<sup>1</sup> True differential.

<sup>2</sup> Pin for pin compatible.

<sup>3</sup> Pseudo differential.



## CONVERTER OPERATION

The AD4002/AD4006/AD4010 are SAR-based ADCs using a charge redistribution sampling digital-to-analog-converter (DAC). Figure 31 shows the simplified schematic of the ADC. The capacitive DAC consists of two identical arrays of 18 binary weighted capacitors, which are connected to the comparator inputs.

During the acquisition phase, terminals of the array tied to the input of the comparator are connected to GND via the SW+ and SW− switches. All independent switches connect the other terminal of each capacitor to the analog inputs. The capacitor arrays are used as sampling capacitors and acquire the analog signal on the IN+ and IN− inputs.

When the acquisition phase is complete and the CNV input goes high, a conversion phase initiates. When the conversion phase begins, SW+ and SW− are opened first. The two capacitor arrays are then disconnected from the inputs and connected to the GND input. The differential voltage between the IN+ and IN− inputs captured at the end of the acquisition phase is applied to the comparator inputs, causing the comparator to become unbalanced. By switching each element of the capacitor array between GND and  $V_{REF}$ , the comparator input varies by binary weighted voltage steps ( $V_{REF}/2, V_{REF}/4, \dots, V_{REF}/262,144$ ). The control logic toggles these switches, starting with the MSB,

to bring the comparator back into a balanced condition. After the completion of this process, the control logic generates the ADC output code and a busy signal indicator.

Because the AD4002/AD4006/AD4010 have on-board conversion clocks, the serial clock, SCK, is not required for the conversion process.

## TRANSFER FUNCTIONS

The ideal transfer characteristics for the AD4002/AD4006/AD4010 are shown in Figure 32 and Table 9.

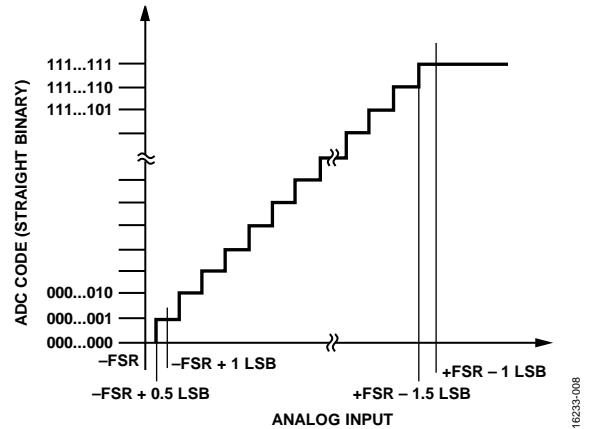

Figure 32. ADC Ideal Transfer Function (FSR Is Full-Scale Range)

Table 9. Output Codes and Ideal Input Voltages

Description	Analog Input, $V_{REF} = 5\text{ V}$	$V_{REF} = 5\text{ V}$ with Span Compression Enabled (V)	Digital Output Code (Hex)
FSR − 1 LSB	4.999981 V	4.499985	0x3FFFF <sup>1</sup>
Midscale + 1 LSB	2.500019 V	2.500015	0x20001
Midscale	2.5 V	2.5	0x20000
Midscale − 1 LSB	2.499981 V	2.499985	0x1FFFF
−FSR + 1 LSB	19.07 $\mu\text{V}$	0.50001526	0x00001
−FSR	0 V	0.5	0x00000 <sup>2</sup>

<sup>1</sup> This output code is also the code for an overranged analog input ( $V_{IN+} - V_{IN-}$  above  $V_{REF}$  with span compression disabled and above  $0.9 \times V_{REF}$  with span compression enabled).

<sup>2</sup> This output code is also the code for an underranged analog input ( $V_{IN+} - V_{IN-}$  below 0 V with span compression disabled and below  $0.1 \times V_{REF}$  with span compression enabled).

APPLICATIONS INFORMATION

TYPICAL APPLICATION DIAGRAMS

Figure 33 shows an example of the recommended connection diagram for the AD4002/AD4006/AD4010 when multiple supplies are available. This configuration is used for best performance because the amplifier supplies can be selected to allow the maximum signal range.

Figure 34 shows a recommended connection diagram when using a single-supply system. This setup is preferable when only a limited number of rails are available in the system and power dissipation is of critical importance.

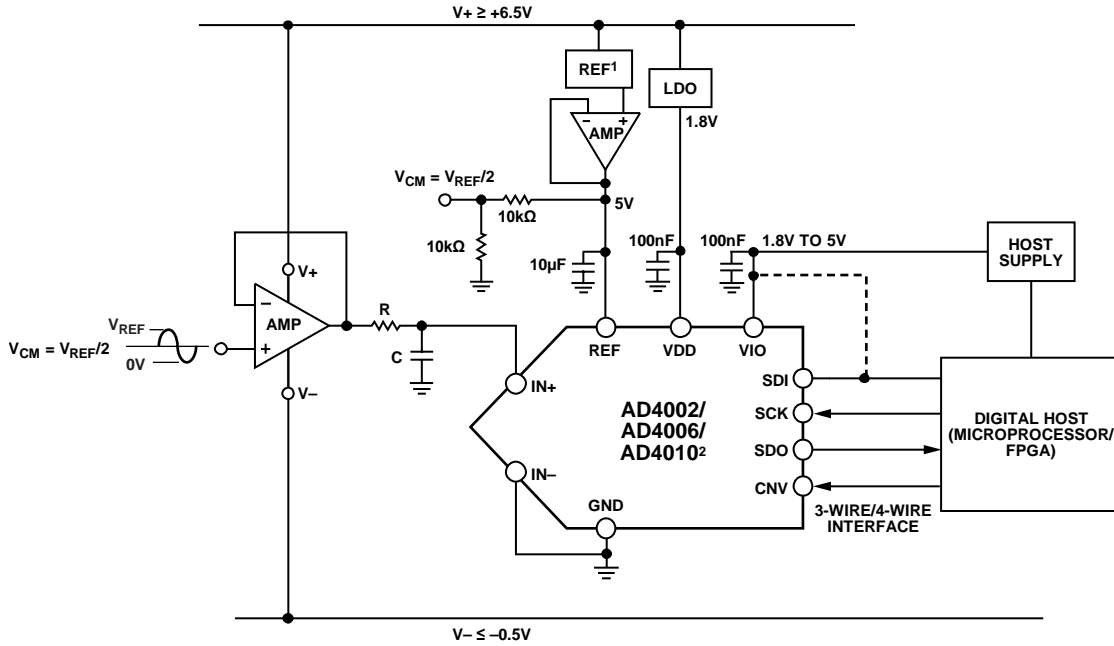
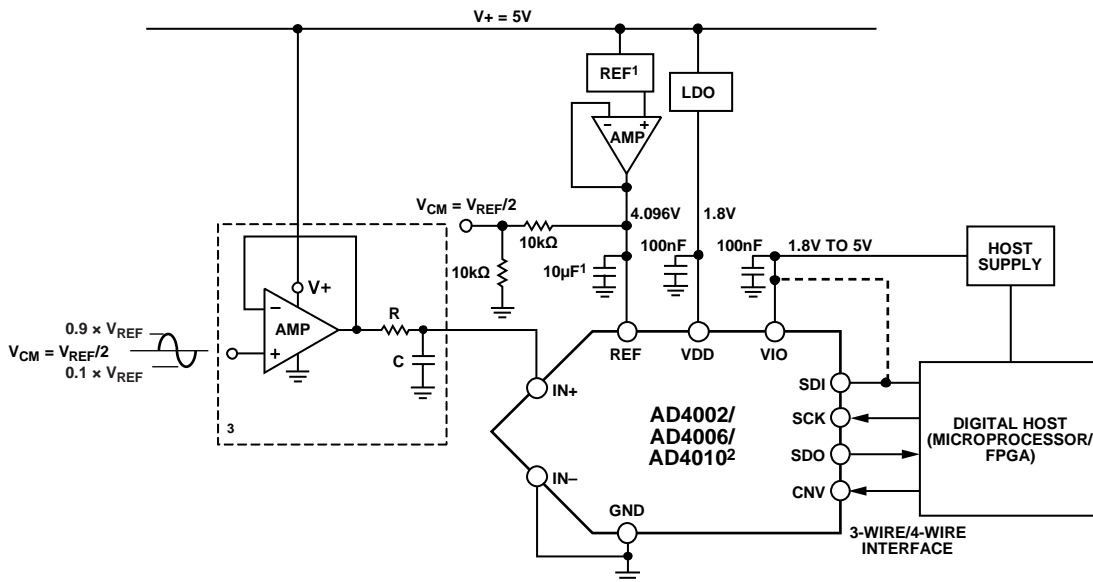

Figure 33. Typical Application Diagram with Multiple Supplies



<sup>1</sup>SEE THE VOLTAGE REFERENCE INPUT SECTION FOR REFERENCE SELECTION. C<sub>REF</sub> IS USUALLY A 10μF CERAMIC CAPACITOR (X7R).  
<sup>2</sup>SPAN COMPRESSION MODE ENABLED.  
<sup>3</sup>SEE TABLE 10 FOR RC FILTER AND AMPLIFIER SELECTION.

Figure 34. Typical Application Diagram with a Single Supply

**ANALOG INPUTS**

Figure 35 shows an equivalent circuit of the analog input structure, including the overvoltage clamp of the AD4002/AD4006/AD4010.

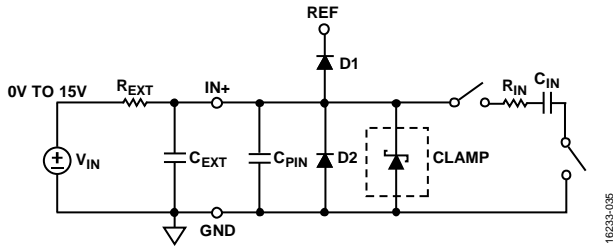

Figure 35. Equivalent Analog Input Circuit

**Input Overvoltage Clamp Circuit**

Most ADC analog inputs, IN+ and IN-, have no overvoltage protection circuitry apart from ESD protection diodes. During an overvoltage event, an ESD protection diode from an analog input pin (IN+ or IN-) to REF forward biases and shorts the input pin to REF, potentially overloading the reference or causing damage to the device. The AD4002/AD4006/AD4010 internal overvoltage clamp circuit with a larger external resistor ( $R_{EXT} = 200 \Omega$ ) eliminates the need for external protection diodes and protects the ADC inputs against dc overvoltages.

In applications where the amplifier rails are greater than  $V_{REF}$  and less than ground, it is possible for the output to exceed the input voltage range of the device. In this case, the AD4002/AD4006/AD4010 internal voltage clamp circuit ensures that the voltage on the input pin does not exceed  $V_{REF} + 0.4 \text{ V}$  and prevents damage to the device by clamping the input voltage in a safe operating range and avoiding disturbance of the reference, which is particularly important for systems that share the reference among multiple ADCs.

If the analog input exceeds the reference voltage by 0.4 V, the internal clamp circuit turns on and the current flows through the clamp into ground, preventing the input from rising further and potentially causing damage to the device. The clamp turns on before D1 (see Figure 35) and can sink up to 50 mA of current.

When the clamp is active, it sets the  $\overline{OV}$  clamp flag bit in the register that can be read back (see Table 14), which is a sticky bit that must be read to be cleared. The status of the clamp can also be checked in the status bits using an overvoltage clamp flag (see Table 15). The clamp circuit does not dissipate static power in the off state. Note that the clamp cannot sustain the overvoltage condition for an indefinite amount of time.

The external RC filter is usually present at the ADC input to band limit the input signal. During an overvoltage event, excessive voltage is dropped across  $R_{EXT}$ , and  $R_{EXT}$  becomes part of a protection circuit. The  $R_{EXT}$  value can vary from  $200 \Omega$  to  $20 \text{ k}\Omega$  for 15 V protection. The  $C_{EXT}$  value can be as low as  $100 \text{ pF}$  for correct operation of the clamp. See Table 1 for input overvoltage clamp specifications.

The analog input structure allows the sampling of the true differential signal between IN+ and IN-. By using these differential inputs, signals common to both inputs are rejected. By using IN- to sense a remote signal ground, ground potential differences between the sensor and the local ADC ground are eliminated.

**Switched Capacitor Input**

During the acquisition phase, the impedance of the analog inputs (IN+ or IN-) can be modeled as a parallel combination of Capacitor  $C_{PIN}$  and the network formed by the series connection of  $R_{IN}$  and  $C_{IN}$ .  $C_{PIN}$  is primarily the pin capacitance.  $R_{IN}$  is typically  $400 \Omega$  and is a lumped component composed of serial resistors and the on resistance of the switches.  $C_{IN}$  is typically  $40 \text{ pF}$  and is mainly the ADC sampling capacitor.

During the conversion phase, in which the switches are open, the input impedance is limited to  $C_{PIN}$ .  $R_{IN}$  and  $C_{IN}$  make a single-pole, low-pass filter that reduces undesirable aliasing effects and limits noise.

**RC Filter Values**

The RC filter value (represented by R and C in Figure 33 and Figure 34) and driving amplifier can be selected depending on the input signal bandwidth of interest at the full throughput. Lower input signal bandwidth means that the RC cutoff can be lower, thereby reducing noise into the converter. For optimum performance at various throughputs, use the recommended RC values ( $200 \Omega$ ,  $180 \text{ pF}$ ) and the ADA4807-1.

The RC values shown in Table 10 are chosen for ease of drive considerations and greater ADC input protection. The combination of a large R value ( $200 \Omega$ ) and small C value results in a reduced dynamic load for the amplifier to drive. The smaller value of C means fewer stability and phase margin concerns with the amplifier. The large value of R limits the current into the ADC input when the amplifier output exceeds the ADC input range.

Table 10. RC Filter and Amplifier Selection for Various Input Bandwidths

Input Signal Bandwidth (kHz)	R ( $\Omega$ )	C (pF)	Recommended Amplifier
<10	See the High-Z Mode section	See the High-Z Mode section	See the High-Z Mode section
<200	200	180	ADA4807-1
>200	200	120	ADA4897-1
Multiplexed	200	120	ADA4897-1

## DRIVER AMPLIFIER CHOICE

Although the AD4002/AD4006/AD4010 are easy to drive, the driver amplifier must meet the following requirements:

- The noise generated by the driver amplifier must be kept low enough to preserve the SNR and transition noise performance of the AD4002/AD4006/AD4010. The noise from the driver is filtered by the single-pole, low-pass filter of the analog input circuit made by  $R_{IN}$  and  $C_{IN}$ , or by the external filter, if one is used. Because the typical noise of the AD4002/AD4006/AD4010 is  $30.4 \mu\text{V}$  rms, the SNR degradation due to the amplifier is

$$SNR_{LOSS} = 20 \log \left( \frac{(30.4 \mu\text{V})}{\sqrt{(30.4 \mu\text{V})^2 + \frac{\pi}{2} f_{-3 \text{ dB}} (Ne_N)^2}} \right)$$

where:

$f_{-3 \text{ dB}}$  is the input bandwidth, in megahertz, of the AD4002/AD4006/AD4010 (10 MHz) or the cutoff frequency of the input filter, if one is used.

$N$  is the noise gain of the amplifier (for example, 1 in buffer configuration).

$e_N$  is the equivalent input noise voltage of the op amp, in  $\text{nV}/\sqrt{\text{Hz}}$ .

- For ac applications, the driver must have a THD performance commensurate with the AD4002/AD4006/AD4010.
- For multichannel multiplexed applications, the driver amplifier and the analog input circuit of the AD4002/AD4006/AD4010 must settle for a full-scale step onto the capacitor array at an 18-bit level (0.000384%, 3.84 ppm). In the data sheet of the amplifier, settling at 0.1% to 0.01% is more commonly specified. This settling may differ significantly from the settling time at an 18-bit level and must be verified prior to driver selection.

## High Frequency Input Signals

The AD4002/AD4006/AD4010 ac performance over a wide input frequency range using a 5 V reference voltage is shown in Figure 36 and Figure 37. Unlike other traditional SAR ADCs, the AD4002/AD4006/AD4010 maintain exceptional ac performance for input frequencies up to the Nyquist frequency with minimal performance degradation. Note that the input frequency is limited to the Nyquist frequency of the sample rate in use.

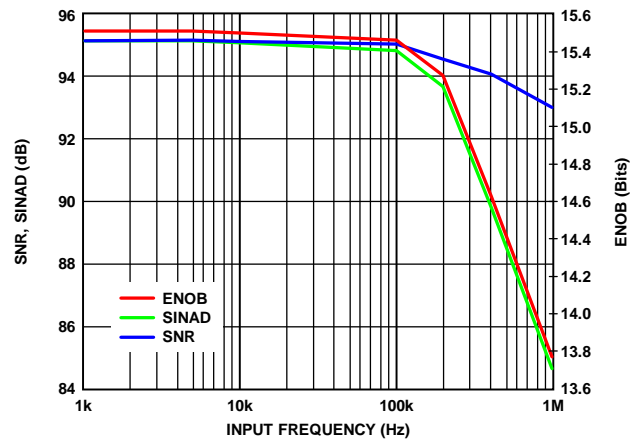

Figure 36. SNR, SINAD, and ENOB vs. Input Frequency,  $V_{DD} = 1.8 \text{ V}$ ,  $V_{IO} = 3.3 \text{ V}$ ,  $V_{REF} = 5 \text{ V}$ ,  $25^\circ\text{C}$

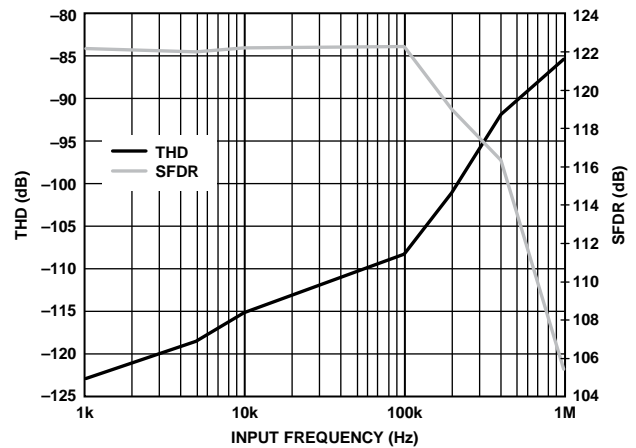

Figure 37. THD and SFDR vs. Input Frequency,  $V_{DD} = 1.8 \text{ V}$ ,  $V_{IO} = 3.3 \text{ V}$ ,  $V_{REF} = 5 \text{ V}$ ,  $25^\circ\text{C}$

**Multiplexed Applications**

The AD4002/AD4006/AD4010 significantly reduce system complexity and cost for multiplexed applications that require superior performance in terms of noise, power, and throughput. Figure 38 shows a simplified block diagram of a multiplexed data acquisition system including a multiplexer, an ADC driver, and the precision SAR ADC.

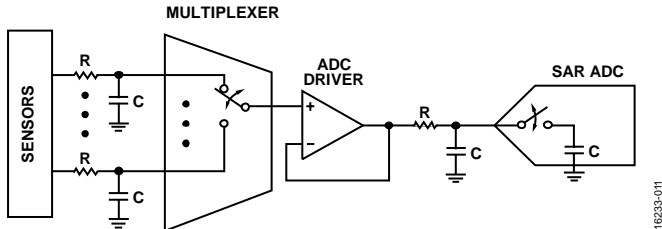

Figure 38. Multiplexed Data Acquisition Signal Chain Using the AD4002/AD4006/AD4010

Switching multiplexer channels typically results in large voltage steps at the ADC inputs. To ensure an accurate conversion result following these voltage steps, the ADC must be given adequate settling time before it samples its inputs (on the subsequent rising edge of CNV). The settling time of the system is dependent on the drive circuitry (multiplexer and ADC driver), RC filter values, and the time when the multiplexer channels are switched. Switch the multiplexer channels immediately after  $t_{QUIET1}$  has elapsed from the start of the conversion to maximize settling time while preventing corruption of the conversion result.

If the analog inputs are multiplexed during the quiet conversion time ( $t_{QUIET1}$ ), the current conversion may be corrupted. To avoid conversion corruption, do not switch the multiplexer channels during the  $t_{QUIET1}$  time.

Figure 39 shows the conversion error vs. settling time when switching between positive and negative full-scale inputs (described in Table 9). The conversion error refers to the deviation between the expected and actual code output for either a positive or negative full-scale input.

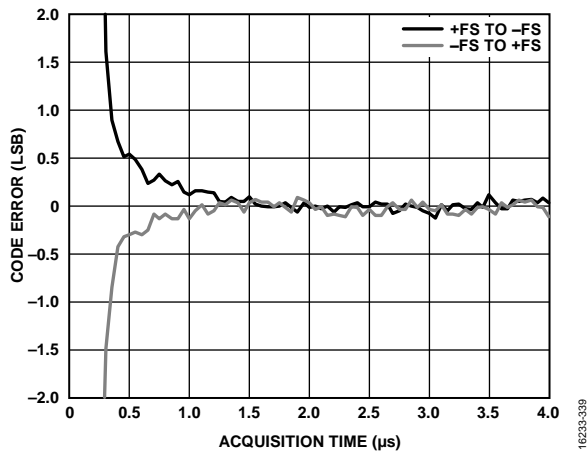

Figure 39. Conversion Error vs. Settling Time with Full-Scale Input Steps,  $V_{DD} = 1.8\text{ V}$ ,  $V_{IO} = 3.3\text{ V}$ ,  $V_{REF} = 5\text{ V}$ ,  $T_A = 25^\circ\text{C}$

**EASE OF DRIVE FEATURES**

**Input Span Compression**

In single-supply applications, it is desirable to use the full range of the ADC; however, the amplifier can have some headroom and footroom requirements, which can be a problem, even if it is a rail-to-rail input and output amplifier. The AD4002/AD4006/AD4010 include a span compression feature, which increases the headroom and footroom available to the amplifier by reducing the input range by 10% from the top and bottom of the range while still accessing all available ADC codes (see Figure 40). The SNR decreases by approximately 1.9 dB ( $20 \times \log(8/10)$ ) for the reduced input range when span compression is enabled. Span compression is disabled by default but can be enabled by writing to the relevant register bit (see the Digital Interface section).

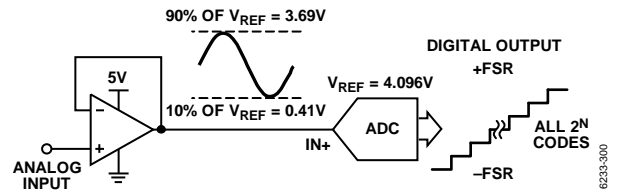

Figure 40. Span Compression

**High-Z Mode**

The AD4002/AD4006/AD4010 incorporate high-Z mode, which reduces the nonlinear charge kickback when the capacitor DAC switches back to the input at the start of acquisition. Figure 41 shows the input current of the AD4002/AD4006/AD4010 with high-Z mode enabled and disabled. The low input current makes the ADC easier to drive than the traditional SAR ADCs available in the market, even with high-Z mode disabled. The input current reduces further to submicroampere range when high-Z mode is enabled. The high-Z mode is disabled by default but can be enabled by writing to the register (see Table 14). Disable high-Z mode for input frequencies above 100 kHz or when multiplexing.

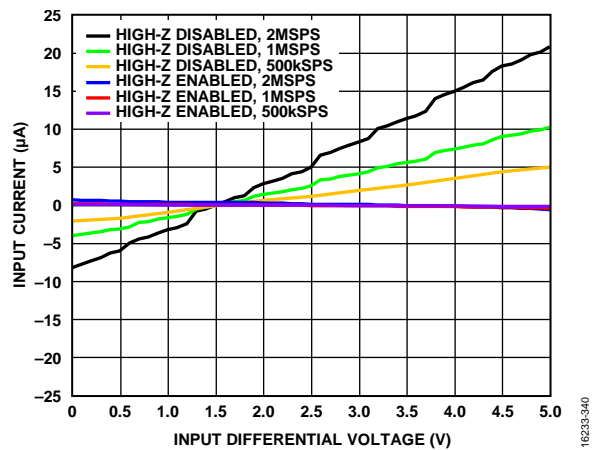

Figure 41. Input Current vs. Input Differential Voltage,  $V_{DD} = 1.8\text{ V}$ ,  $V_{IO} = 3.3\text{ V}$ ,  $V_{REF} = 5\text{ V}$ ,  $T_A = 25^\circ\text{C}$

To achieve the optimum data sheet performance from high resolution precision SAR ADCs, system designers are often forced to use a dedicated high power, high speed amplifier to drive the traditional switched capacitor SAR ADC inputs for their precision applications, which is commonly encountered in designing a precision data acquisition signal chain. The benefits of high-Z mode are low input current for slow (<10 kHz) or dc type signals and improved distortion (THD) performance over a frequency range of up to 100 kHz. High-Z mode allows a choice of lower power and lower bandwidth precision amplifiers with a lower RC filter cutoff to drive the ADC, removing the need for dedicated high speed ADC drivers, which saves system power, size, and cost in precision, low bandwidth applications. High-Z mode allows the amplifier and RC filter in front of the ADC to be chosen based on the signal bandwidth of interest and not based on the settling requirements of the switched capacitor SAR ADC inputs.

Additionally, the AD4002/AD4006/AD4010 can be driven with a much higher source impedance than traditional SARs, which means the resistor in the RC filter can have a value 10 times larger than previous SAR designs and with high-Z mode enabled can tolerate even larger impedance. Figure 42 shows the THD performance for various source impedances with high-Z mode disabled and enabled.

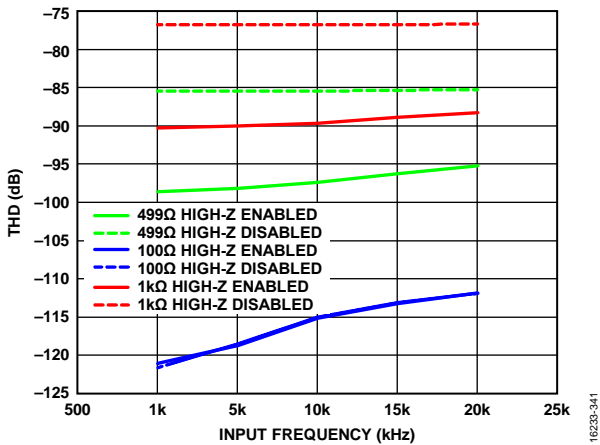

Figure 42. THD vs. Input Frequency for Various Source Impedances,  $V_{DD} = 1.8\text{ V}$ ,  $V_{IO} = 3.3\text{ V}$ ,  $V_{REF} = 5\text{ V}$ ,  $T_A = 25^\circ\text{C}$

Figure 43 and Figure 44 show the AD4002/AD4006/AD4010 SNR and THD performance using the ADA4077-1 (supply current per amplifier ( $I_{SY}$ ) = 400  $\mu\text{A}$ ), and ADA4610-1 ( $I_{SY}$  = 1.50 mA) precision amplifiers when driving the AD4002 at full throughput (2 MSPS) for high-Z mode both enabled and disabled with various RC filter values. These amplifiers achieve 93.2 dB and 90.7 dB typical SNR and -111 dB and -105 dB typical THD with high-Z enabled for a 2.27 MHz RC bandwidth, respectively. THD is approximately 10 dB better with high-Z mode enabled, even for large R values. SNR maintains close to 88 dB even with a very low RC filter cutoff.

When high-Z mode is enabled, the ADC consumes approximately 2 mW per MSPS extra power; however, this is still significantly lower than using dedicated ADC drivers like the ADA4807-1. For any system, the front end usually limits the overall ac/dc performance of the signal chain. It is evident from the data sheets of the selected precision amplifiers shown in Figure 43 and Figure 44 that their own noise and distortion performance dominates the SNR and THD specification at a certain input frequency.

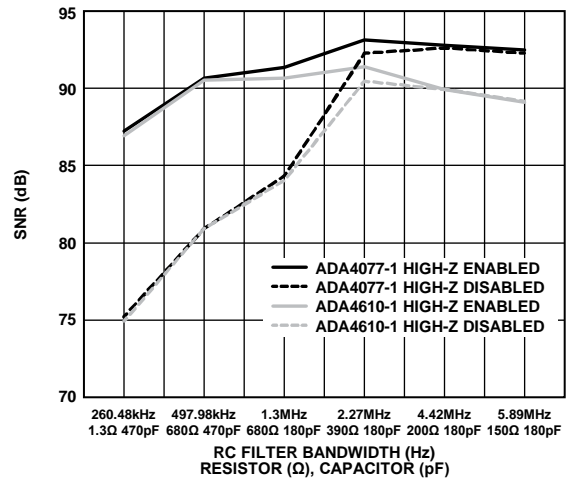

Figure 43. SNR vs. RC Filter Bandwidths for Various Precision ADC Drivers,  $f_{IN} = 1\text{ kHz}$  (Turbo Mode On, High-Z Enabled/Disabled),  $V_{DD} = 1.8\text{ V}$ ,  $V_{IO} = 3.3\text{ V}$ ,  $V_{REF} = 5\text{ V}$ ,  $T_A = 25^\circ\text{C}$

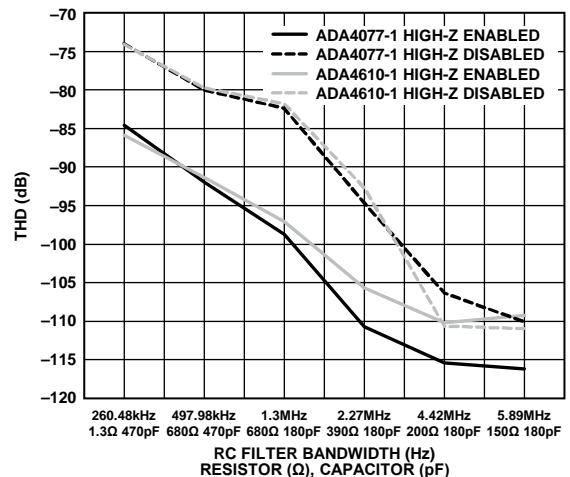

Figure 44. THD vs. RC Bandwidths for Various Precision ADC Drivers,  $f_{IN} = 1\text{ kHz}$  (Turbo Mode On, High-Z Enabled/Disabled),  $V_{DD} = 1.8\text{ V}$ ,  $V_{IO} = 3.3\text{ V}$ ,  $V_{REF} = 5\text{ V}$ ,  $T_A = 25^\circ\text{C}$



**Long Acquisition Phase**

The AD4002/AD4006/AD4010 also feature a very fast conversion time of 290 ns, which results in a long acquisition phase. The acquisition is further extended by a key feature of the AD4002/AD4006/AD4010: the ADC returns to the acquisition phase typically 100 ns before the end of the conversion. This feature provides an even longer time for the ADC to acquire the new input voltage. A longer acquisition phase reduces the settling requirement on the driving amplifier, and a lower power/bandwidth amplifier can be chosen. The longer acquisition phase means that a lower RC filter (represented by R and C in Figure 33 and Figure 34) cutoff can be used, which means a noisier amplifier can also be tolerated. A larger value of R can be used in the RC filter with a corresponding smaller value of C, reducing amplifier stability concerns without affecting distortion performance significantly. A larger value of R also results in reduced dynamic power dissipation in the amplifier.

See Table 10 for details on setting the RC filter bandwidth and choosing a suitable amplifier.

**VOLTAGE REFERENCE INPUT**

A 10  $\mu$ F (X7R, 0805 size) ceramic chip capacitor is appropriate for the optimum performance of the reference input.

For higher performance and lower drift, use a reference such as the ADR4550. Use a low power reference such as the ADR3450 at the expense of a slight decrease in the noise performance. It is recommended to use a reference buffer, such as the ADA4807-1, between the reference and the ADC reference input. It is important to consider the optimum capacitance necessary to keep the reference buffer stable as well as to meet the minimum ADC requirement stated previously in this section (that is, a 10  $\mu$ F ceramic chip capacitor,  $C_{REF}$ ).

**POWER SUPPLY**

The AD4002/AD4006/AD4010 use two power supply pins: a core supply (VDD) and a digital input/output interface supply (VIO). VIO allows direct interface with any logic between 1.8 V and 5.5 V. To reduce the number of supplies needed, VIO and VDD can be tied together for 1.8 V operation. The ADP7118 low noise, CMOS, low dropout (LDO) linear regulator is recommended to power the VDD and VIO pins. The AD4002/AD4006/AD4010 are independent of power supply sequencing between VIO and VDD. Additionally, the AD4002/AD4006/AD4010 are insensitive to power supply variations over a wide frequency range, as shown in Figure 45.

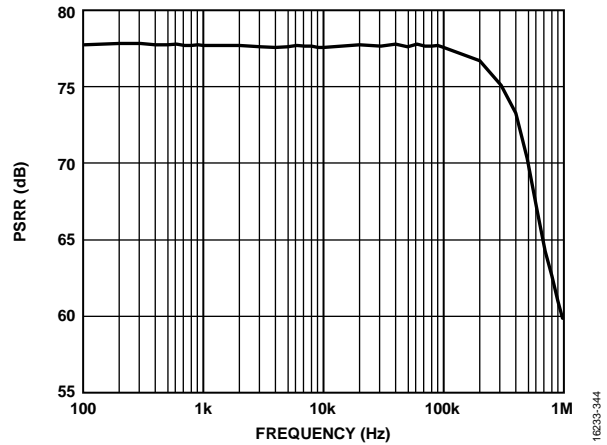

Figure 45. PSRR vs. Frequency, VDD = 1.8 V, VIO = 3.3 V, VREF = 5 V, TA = 25°C

The AD4002/AD4006/AD4010 power down automatically at the end of each conversion phase; therefore, the power scales linearly with the sampling rate. This feature makes the device ideal for low sampling rates (even a few samples per second) and battery-powered applications. Figure 46 shows the AD4002/AD4006/AD4010 total power dissipation and individual power dissipation for each rail.

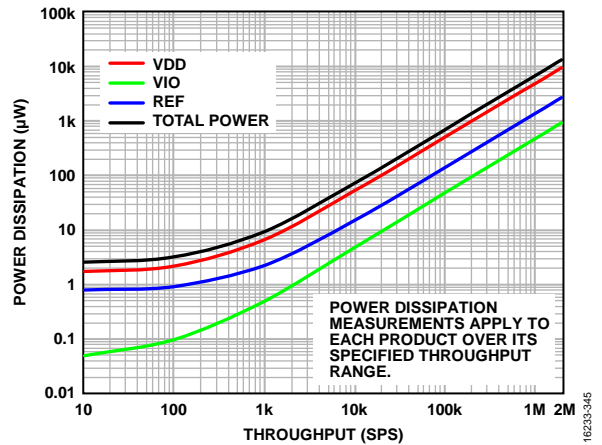

Figure 46. Power Dissipation vs. Throughput, VDD = 1.8 V, VIO = 1.8 V, VREF = 5 V, TA = 25°C

## DIGITAL INTERFACE

Although the AD4002/AD4006/AD4010 have a reduced number of pins, they offer flexibility in their serial interface modes. The AD4002/AD4006/AD4010 can also be programmed via 16-bit SPI writes to the configuration registers.

When in  $\overline{\text{CS}}$  mode, the AD4002/AD4006/AD4010 are compatible with SPI, QSPI™, MICROWIRE®, digital hosts, and digital signal processors (DSPs). In this mode, the AD4002/AD4006/AD4010 can use either a 3-wire or 4-wire interface. A 3-wire interface using the CNV, SCK, and SDO signals minimizes wiring connections, which is useful, for instance, in isolated applications. A 4-wire interface using the SDI, CNV, SCK, and SDO signals allows CNV, which initiates the conversions, to be independent of the readback timing (SDI). This interface is useful in low jitter sampling or simultaneous sampling applications.

The AD4002/AD4006/AD4010 provide a daisy-chain feature using the SDI input for cascading multiple ADCs on a single data line, similar to a shift register.

The mode in which the device operates depends on the SDI level when the CNV rising edge occurs.  $\overline{\text{CS}}$  mode is selected if SDI is high, and daisy-chain mode is selected if SDI is low. The SDI hold time is such that when SDI and CNV are connected together, daisy-chain mode is always selected.

In either 3-wire or 4-wire mode, the AD4002/AD4006/AD4010 offer the option of forcing a start bit in front of the data bits. This start bit can be used as a busy signal indicator to interrupt the digital host and trigger the data reading. Otherwise, without a busy indicator, the user must time out the maximum conversion time prior to readback.

The busy indicator feature is enabled in  $\overline{\text{CS}}$  mode if CNV or SDI is low when the ADC conversion ends.

The state of SDO on power-up is either low or high-Z, depending on the states of CNV and SDI, as shown in in Table 11.

**Table 11. State of SDO on Power-Up**

CNV	SDI	SDO
0	0	Low
0	1	Low
1	0	Low
1	1	High-Z

The AD4002/AD4006/AD4010 have turbo mode capability in both 3-wire and 4-wire mode. Turbo mode is enabled by writing to the configuration register and replaces the busy indicator feature when enabled. Turbo mode allows a slower SPI clock rate, making interfacing simpler. The maximum throughput of 2 MSPS for the AD4002 can be achieved only with turbo mode enabled and a minimum SCK rate of 75 MHz.

The SCK rate must be sufficiently fast to ensure the conversion result is clocked out before another conversion is initiated. The minimum required SCK rate for an application can be derived based on the sample period ( $t_{\text{CYC}}$ ), the number of bits that must be read (including data and optional status bits), and which digital interface mode is used. Timing diagrams and explanations for each digital interface mode are given in the digital modes of operation sections (see the  $\overline{\text{CS}}$  Mode, 3-Wire Turbo Mode section through the Daisy-Chain Mode section).

Status bits can also be clocked out at the end of the conversion data if the status bits are enabled in the configuration register. There are six status bits in total, as shown in Table 15.

The AD4002/AD4006/AD4010 are configured by 16-bit SPI writes to the desired configuration register. The 16-bit word can be written via the SDI line while CNV is held low. The 16-bit word consists of an 8-bit header and 8-bit register data. For isolated systems, the ADuM141D is recommended, which can support the 75 MHz SCK rate required to run the AD4002 at its full throughput of 2 MSPS.

## REGISTER READ/WRITE FUNCTIONALITY

The AD4002/AD4006/AD4010 register bits are programmable and their default statuses are shown in Table 12. The register map is shown in Table 14. The overvoltage clamp flag (OV) is a read only sticky bit, and it is cleared only if the register is read and the overvoltage condition is no longer present. It gives an indication of overvoltage condition when it is set to 0.

**Table 12. Register Bits**

Register Bits	Default Status
Overvoltage (OV) Clamp Flag	1 bit, 1 = inactive (default)
Span Compression	1 bit, 0 = disabled (default)
High-Z Mode	1 bit, 0 = disabled (default)
Turbo Mode	1 bit, 0 = disabled (default)
Enable Six Status Bits	1 bit, 0 = disabled (default)



All access to the register map must start with a write to the 8-bit command register in the SPI interface block. The AD4002/AD4006/AD4010 ignore all 1s until the first 0 is clocked in; the value loaded into the command register is always a 0 followed by seven command bits. This command determines whether that operation is a write or a read. The AD4002/AD4006/AD4010 command register is shown in Table 13.

**Table 13. Command Register**

Bit 7	Bit 6	Bit 5	Bit 4	Bit 3	Bit 2	Bit 1	Bit 0
WEN	R/W	0	1	0	1	0	0

All register read/writes must occur while CNV is low. Data on SDI is clocked in on the rising edge of SCK. Data on SDO is clocked out on the falling edge of SCK. At the end of the data transfer, SDO is put in a high impedance state on the rising edge of CNV if daisy-chain mode is not enabled. If daisy-chain mode is enabled, SDO goes low on the rising edge of CNV. Register reads are not allowed in daisy-chain mode.

A register write requires three signal lines: SCK, CNV, and SDI. During a register write, to read the current conversion results on SDO, the CNV pin must be brought low after the conversion is completed; otherwise, the conversion results may be incorrect on SDO. However, the register write occurs regardless.

The LSB of each configuration register is reserved because a user reading 16-bit conversion data may be limited to a 16-bit SPI frame. The state of SDI on the last bit in the SDI frame may be the state that then persists when CNV rises. Because interface mode is partly set based on the SDI state when CNV rises, in this scenario, the user may need to set the final SDI state.

The timing diagrams in Figure 47 through Figure 49 show how data is read and written when the AD4002/AD4006/AD4010 are configured in register read, write, and daisy-chain mode.

**Table 14. Register Map**

ADDR[1:0]	Bit 7	Bit 6	Bit 5	Bit 4	Bit 3	Bit 2	Bit 1	Bit 0	Reset
0x0	Reserved	Reserved	Reserved	Enable six status bits	Span compression	High-Z mode	Turbo mode	Overvoltage (OV) clamp flag (read only sticky bit)	0xE1

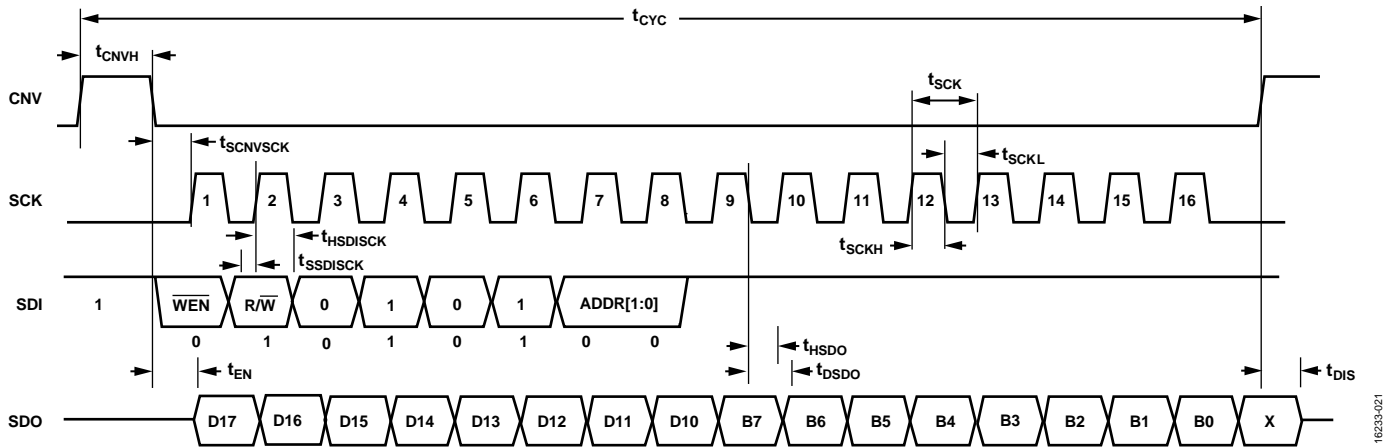
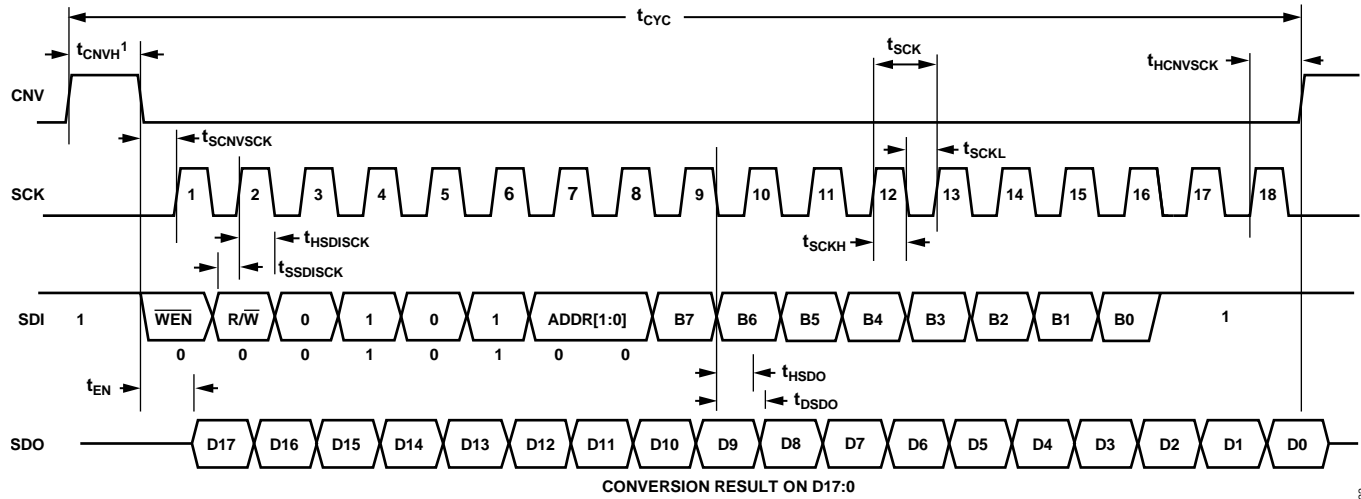

Figure 47. Register Read Timing Diagram (X Means Don't Care)

16233-021



CONVERSION RESULT ON D17:0

<sup>1</sup>THE USER MUST WAIT  $t_{CONV}$  TIME WHEN READING BACK THE CONVERSION RESULT AND PERFORMING A REGISTER WRITE AT THE SAME TIME.

Figure 48. Register Write Timing Diagram

16233-022

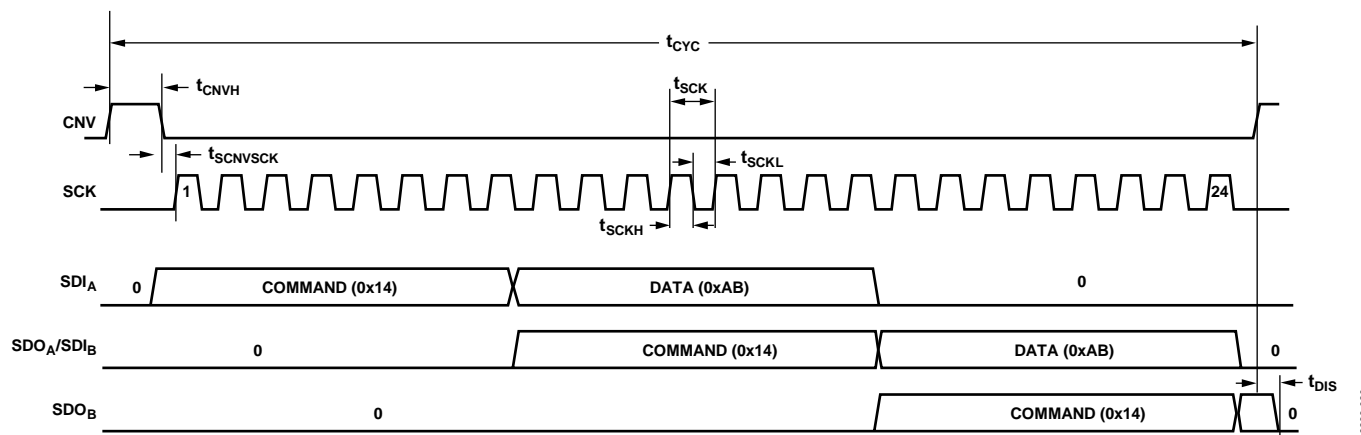

Figure 49. Register Write Timing Diagram, Daisy-Chain Mode

16233-020

**STATUS WORD**

The 6-bit status word can be appended to the end of a conversion result, and the default conditions of these bits are shown in Table 15. The status bits must be enabled in the register setting. When the overvoltage clamp flag ( $\overline{OV}$ ) is a 0, it indicates an overvoltage condition. The overvoltage clamp flag status bit updates on a per conversion basis.

The SDO line goes to high-Z after the sixth status bit is clocked out (except in daisy-chain mode). The user is not required to clock out all status bits to start the next conversion. The serial interface timing for  $\overline{CS}$  mode, 3-wire without busy indicator, including status bits, is shown in Figure 50.

**Table 15. Status Bits (Default Conditions)**

Bit 5	Bit 4	Bit 3	Bit 2	Bit 1	Bit 0
Overvoltage ( $\overline{OV}$ ) clamp flag	Span compression	High-Z mode	Turbo mode	Reserved	Reserved

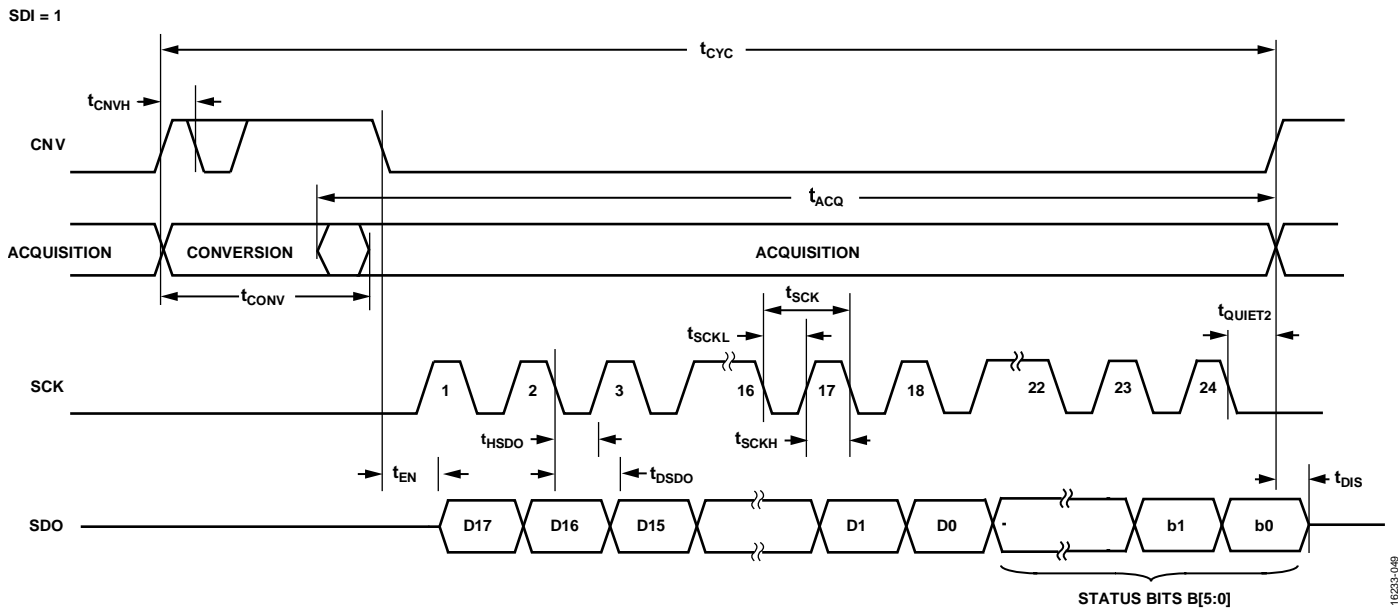

Figure 50.  $\overline{CS}$  Mode, 3-Wire Without Busy Indicator Serial Interface Timing Diagram, Including Status Bits (SDI High)

**CS MODE, 3-WIRE TURBO MODE**

This mode is typically used when a single AD4002/AD4006/AD4010 device is connected to an SPI-compatible digital host. It provides additional time during the end of the ADC conversion process to clock out the previous conversion result, providing a lower SCK rate. The AD4002 can achieve a throughput rate of 2 MSPS only when turbo mode is enabled and using a minimum SCK rate of 75 MHz. With turbo mode enabled, the AD4006 can also achieve its maximum throughput rate of 1 MSPS with a minimum SCK rate of 25 MHz, and the AD4010 can achieve its maximum throughput rate of 500 kSPS with a minimum SCK rate of 11 MHz. The connection diagram is shown in Figure 51, and the corresponding timing diagram is shown in Figure 52.

This mode replaces the 3-wire with busy indicator mode by programming the turbo mode bit, Bit 1 (see Table 14).

When SDI is forced high, a rising edge on CNV initiates a conversion. The previous conversion data is available to read after the CNV rising edge. The user must wait  $t_{QUIET1}$  time after CNV is brought high before bringing CNV low to clock out the previous conversion result. The user must also wait  $t_{QUIET2}$  time after the last falling edge of SCK to when CNV is brought high.

When the conversion is complete, the AD4002/AD4006/AD4010 enter the acquisition phase and power down. When CNV goes low, the MSB is output to SDO. The remaining data bits are clocked by subsequent SCK falling edges. The data is valid on both SCK edges. Although the rising edge can capture the data, a digital host using the SCK falling edge allows a faster reading rate, provided it has an acceptable hold time. After the 18<sup>th</sup> SCK falling edge or when CNV goes high (whichever occurs first), SDO returns to high impedance.

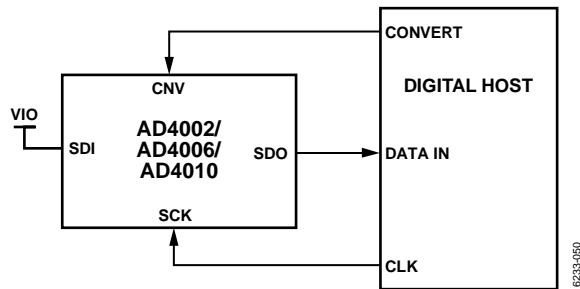

Figure 51. CS Mode, 3-Wire Turbo Mode Connection Diagram (SDI High)

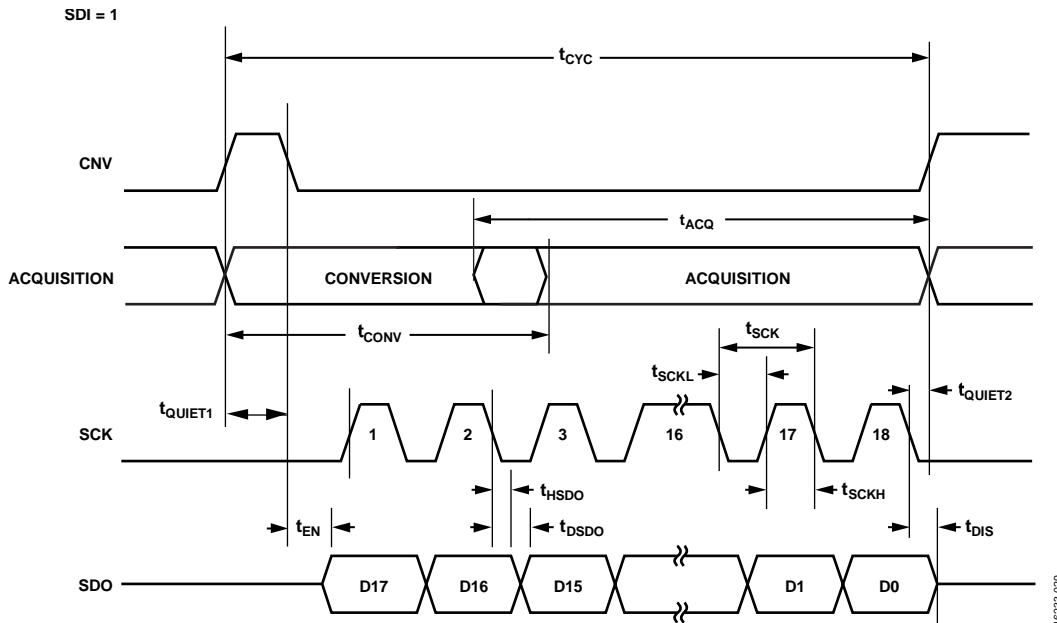

Figure 52. CS Mode, 3-Wire Turbo Mode Serial Interface Timing Diagram (SDI High)

**$\overline{CS}$  MODE, 3-WIRE WITHOUT BUSY INDICATOR**

This mode is typically used when a single AD4002/AD4006/AD4010 device is connected to an SPI-compatible digital host.

The connection diagram is shown in Figure 53, and the corresponding timing diagram is shown in Figure 54.

With SDI tied to VIO, a rising edge on CNV initiates a conversion, selects the  $\overline{CS}$  mode, and forces SDO to high impedance. After a conversion is initiated, it continues until completion irrespective of the state of CNV. This feature can be useful, for instance, to bring CNV low to select other SPI devices, such as analog multiplexers; however, CNV must be returned high before the minimum conversion time elapses and then held high for the maximum possible conversion time to avoid the generation of the busy signal indicator.

When the conversion is complete, the AD4002/AD4006/AD4010 enter the acquisition phase and power down. When CNV goes low, the MSB is output onto SDO. The remaining data bits are clocked by subsequent SCK falling edges. The data is valid on both SCK edges. Although the rising edge can capture the data, a digital host using the SCK falling edge allows a faster reading rate, provided it has an acceptable hold time. After the 18<sup>th</sup> SCK falling edge or when CNV goes high (whichever occurs first), SDO returns to high impedance.

There must not be any digital activity on SCK during the conversion.

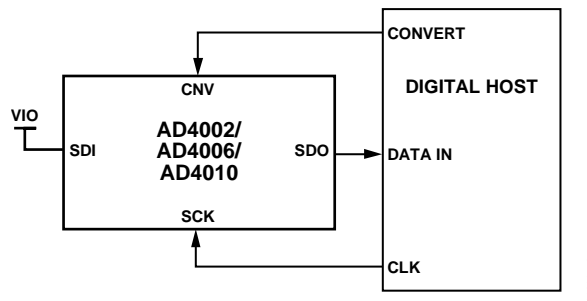

Figure 53.  $\overline{CS}$  Mode, 3-Wire Without Busy Indicator Connection Diagram (SDI High)

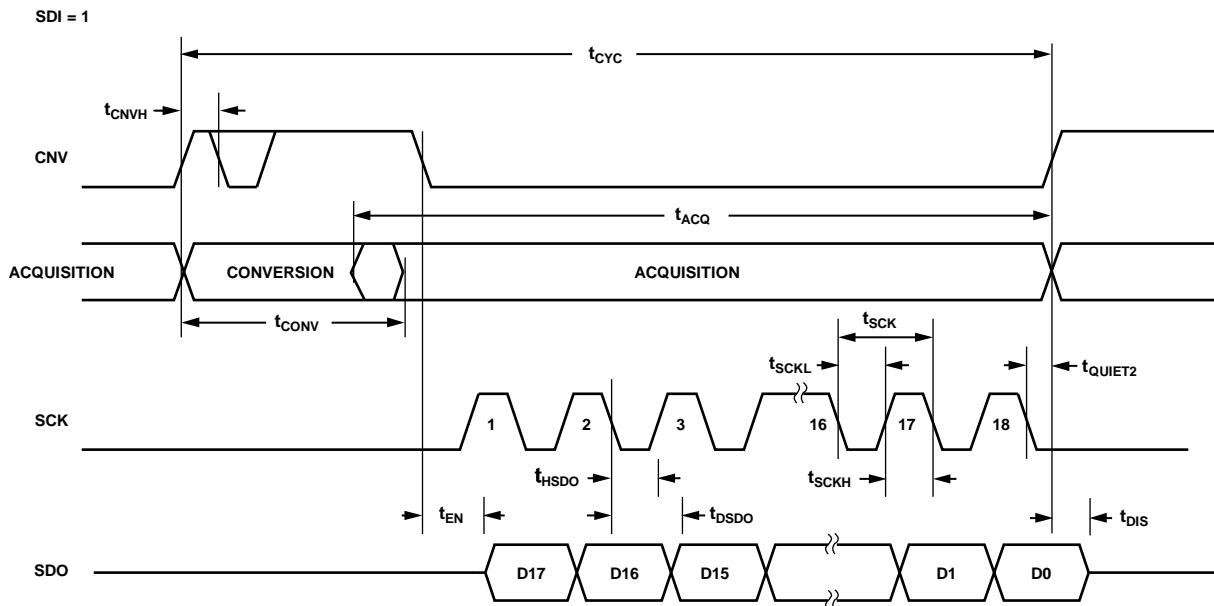

Figure 54.  $\overline{CS}$  Mode, 3-Wire Without Busy Indicator Serial Interface Timing Diagram (SDI High)

**CS MODE, 3-WIRE WITH BUSY INDICATOR**

This mode is typically used when a single AD4002/AD4006/AD4010 device is connected to an SPI-compatible digital host with an interrupt input ( $\overline{\text{IRQ}}$ ).

The connection diagram is shown in Figure 55, and the corresponding timing diagram is shown in Figure 56.

With SDI tied to VIO, a rising edge on CNV initiates a conversion, selects the CS mode, and forces SDO to high impedance. SDO is maintained in high impedance until the completion of the conversion, irrespective of the state of CNV. Prior to the minimum conversion time, CNV can select other SPI devices, such as analog multiplexers; however, CNV must be returned low before the minimum conversion time elapses and then held low for the maximum possible conversion time to guarantee the generation of the busy signal indicator.

When the conversion is complete, SDO goes from high impedance to low impedance. With a pull-up resistor of 1 k $\Omega$  on the SDO line, this transition can be used as an interrupt signal to initiate

the data reading controlled by the digital host. The AD4002/AD4006/AD4010 then enter the acquisition phase and power down. The data bits are then clocked out, MSB first, by subsequent SCK falling edges. The data is valid on both SCK edges. Although the rising edge can capture the data, a digital host using the SCK falling edge allows a faster reading rate, provided it has an acceptable hold time. After the optional 19<sup>th</sup> SCK falling edge or when CNV goes high (whichever occurs first), SDO returns to high impedance.

If multiple AD4002/AD4006/AD4010 devices are selected at the same time, the SDO output pin handles this contention without damage or induced latch-up. Meanwhile, it is recommended to keep this contention as short as possible to limit extra power dissipation.

There must not be any digital activity on the SCK during the conversion.

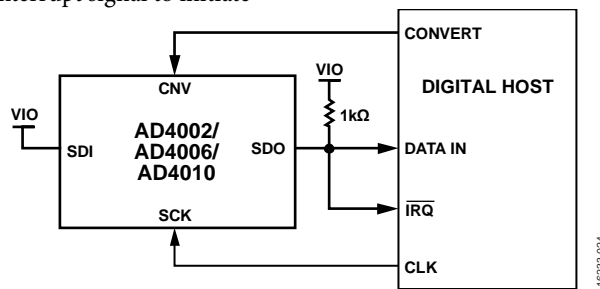

Figure 55. CS Mode, 3-Wire with Busy Indicator Connection Diagram (SDI High)

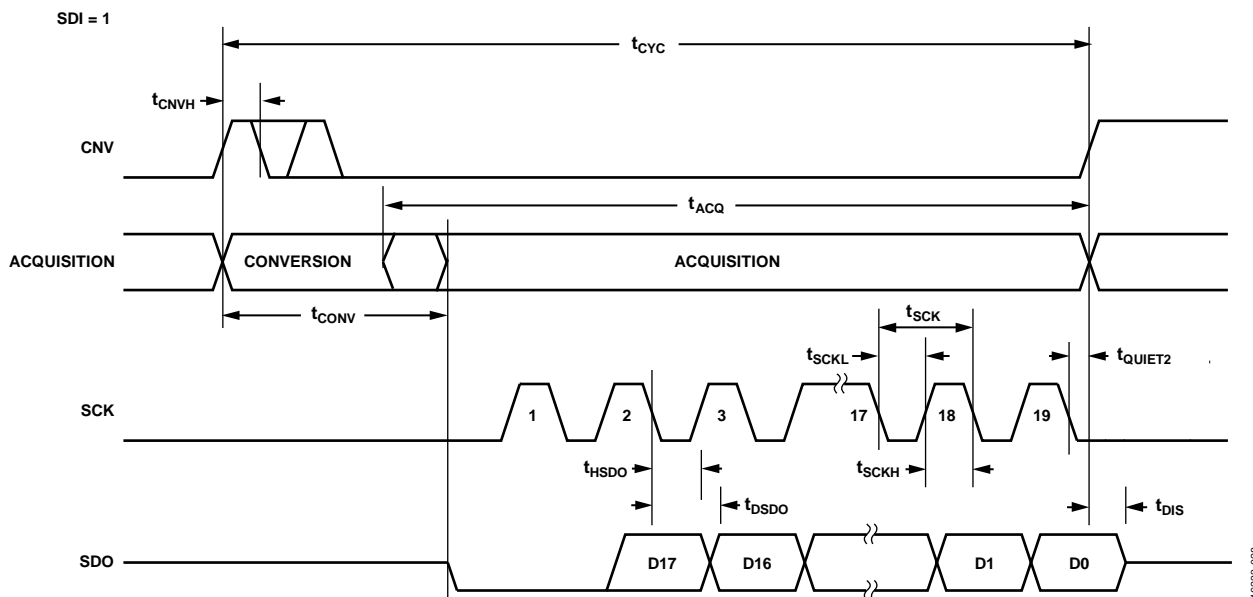

Figure 56. CS Mode, 3-Wire with Busy Indicator Serial Interface Timing Diagram (SDI High)

**CS MODE, 4-WIRE TURBO MODE**

This mode is typically used when a single AD4002/AD4006/AD4010 device is connected to an SPI-compatible digital host. It provides additional time during the end of the ADC conversion process to clock out the previous conversion result, giving a lower SCK rate. The AD4002 can achieve a throughput rate of 2 MSPS only when turbo mode is enabled and using a minimum SCK rate of 75 MHz. With turbo mode enabled, the AD4006 can also achieve its maximum throughput rate of 1 MSPS with a minimum SCK rate of 25 MHz, and the AD4010 can achieve its maximum throughput rate of 500 kSPS with a minimum SCK rate of 11 MHz.

The connection diagram is shown in Figure 57, and the corresponding timing diagram is shown in Figure 58.

This mode replaces the 4-wire with busy indicator mode by programming the turbo mode bit, Bit 1 (see Table 14).

With SDI high, a rising edge on CNV initiates a conversion. The previous conversion data is available to read after the CNV rising edge. The user must wait  $t_{QUIET1}$  time after CNV is brought high before bringing SDI low to clock out the previous conversion result. The user must also wait  $t_{QUIET2}$  time after the last falling edge of SCK to when CNV is brought high.

When the conversion is complete, the AD4002/AD4006/AD4010 enter the acquisition phase and power down. The ADC result can be read by bringing its SDI input low, which consequently outputs the MSB onto SDO. The remaining data bits are then clocked by subsequent SCK falling edges. The data is valid on both SCK edges. Although the rising edge can capture the data, a digital host using the SCK falling edge allows a faster reading rate, provided it has an acceptable hold time. After the 18<sup>th</sup> SCK falling edge or when SDI goes high (whichever occurs first), SDO returns to high impedance.

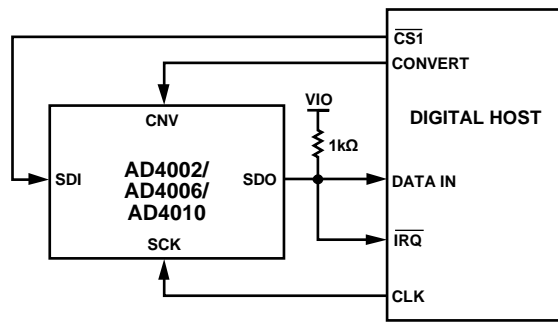

Figure 57. CS Mode, 4-Wire Turbo Mode Connection Diagram

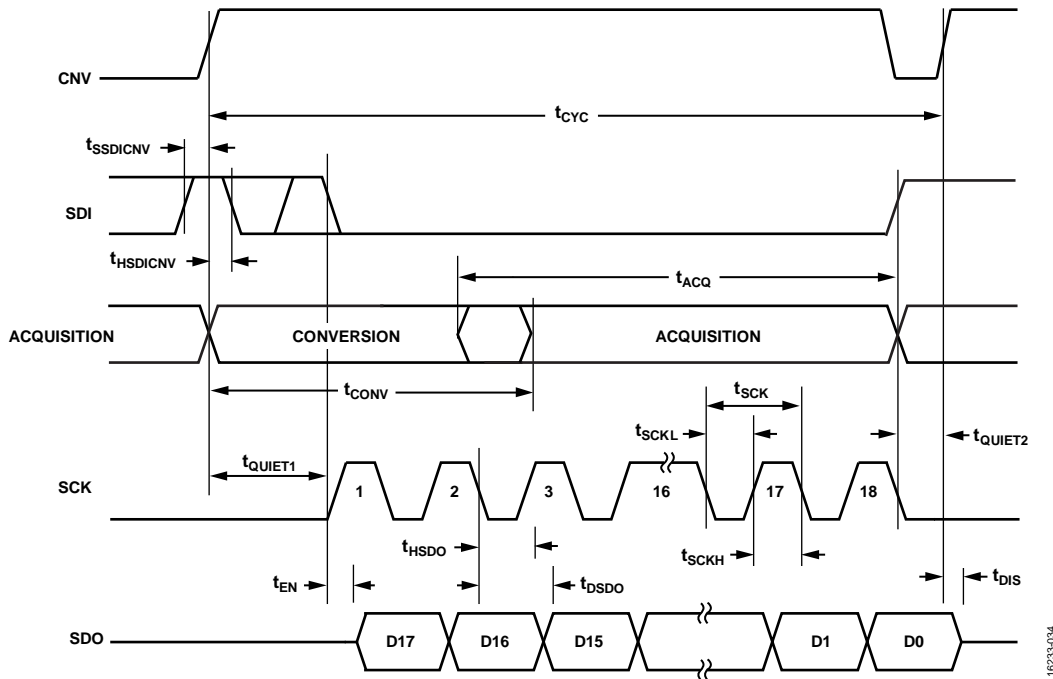

Figure 58. CS Mode, 4-Wire Turbo Mode Timing Diagram

**CS Mode, 4-Wire Without Busy Indicator**

This mode is typically used when multiple AD4002/AD4006/AD4010 devices are connected to an SPI-compatible digital host.

A connection diagram example using two AD4002/AD4006/AD4010 devices is shown in Figure 59, and the corresponding timing diagram is shown in Figure 60.

With SDI high, a rising edge on CNV initiates a conversion, selects the CS mode, and forces SDO to high impedance. In this mode, CNV must be held high during the conversion phase and the subsequent data read back. If SDI and CNV are low, SDO is driven low. Prior to the minimum conversion time, SDI can select other SPI devices, such as analog multiplexers; however, SDI must be returned high before the minimum conversion

time elapses and then held high for the maximum possible conversion time to avoid the generation of the busy signal indicator.

When the conversion is complete, the AD4002/AD4006/AD4010 enter the acquisition phase and power down. Each ADC result can be read by bringing its SDI input low, which consequently outputs the MSB onto SDO. The remaining data bits are then clocked by subsequent SCK falling edges. The data is valid on both SCK edges. Although the rising edge can capture the data, a digital host using the SCK falling edge allows a faster reading rate, provided it has an acceptable hold time. After the 18<sup>th</sup> SCK falling edge or when SDI goes high (whichever occurs first), SDO returns to high impedance and another AD4002/AD4006/AD4010 can be read.

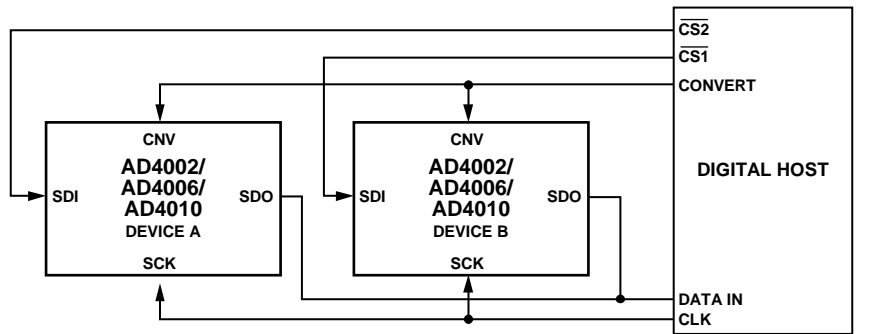

Figure 59. CS Mode, 4-Wire Without Busy Indicator Connection Diagram

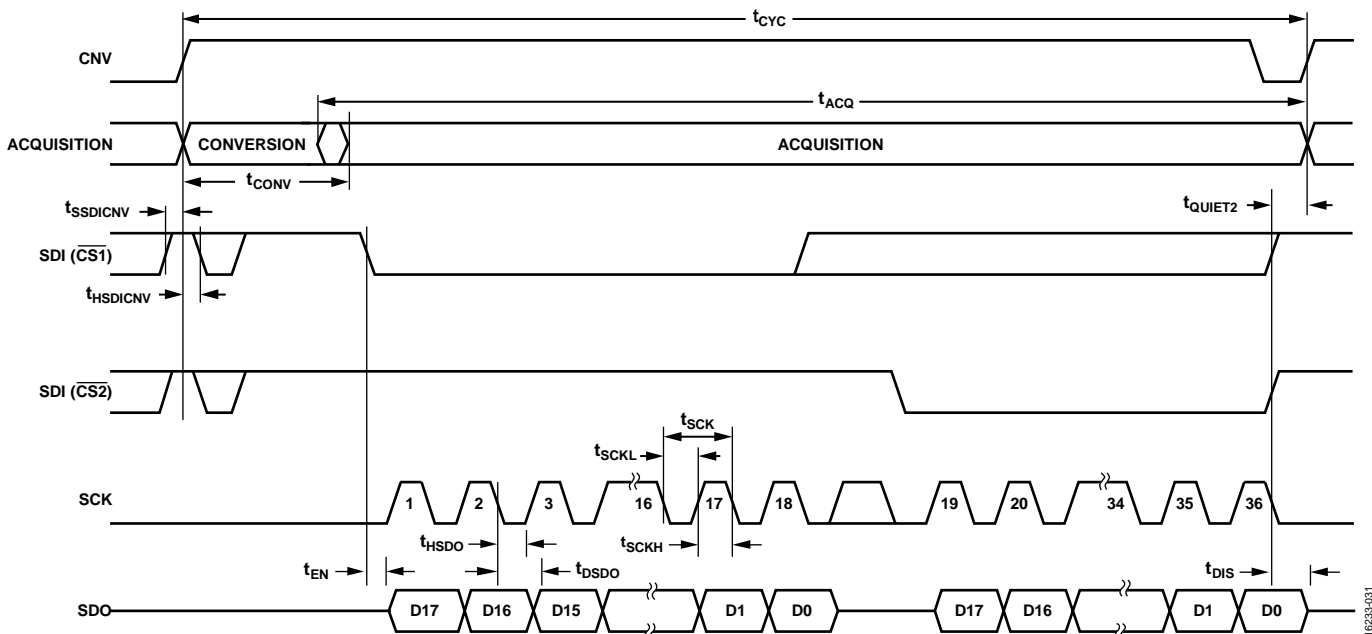

Figure 60. CS Mode, 4-Wire Without Busy Indicator Serial Interface Timing Diagram



**$\overline{CS}$  MODE, 4-WIRE WITH BUSY INDICATOR**

This mode is typically used when a single AD4002/AD4006/AD4010 device is connected to an SPI-compatible digital host with an interrupt input ( $\overline{IRQ}$ ), and when it is desired to keep  $\overline{CNV}$ , which samples the analog input, independent of the signal used to select the data reading. This independence is particularly important in applications where low jitter on  $\overline{CNV}$  is desired.

The connection diagram is shown in Figure 61, and the corresponding timing diagram is shown in Figure 62.

With  $\overline{SDI}$  high, a rising edge on  $\overline{CNV}$  initiates a conversion, selects the  $\overline{CS}$  mode, and forces  $\overline{SDO}$  to high impedance. In this mode,  $\overline{CNV}$  must be held high during the conversion phase and the subsequent data read back. If  $\overline{SDI}$  and  $\overline{CNV}$  are low,  $\overline{SDO}$  is driven low. Prior to the minimum conversion time,  $\overline{SDI}$  can select other SPI devices, such as analog multiplexers; however,

$\overline{SDI}$  must be returned low before the minimum conversion time elapses and then held low for the maximum possible conversion time to guarantee the generation of the busy signal indicator.

When the conversion is complete,  $\overline{SDO}$  goes from high impedance to low impedance. With a pull-up resistor of 1 k $\Omega$  on the  $\overline{SDO}$  line, this transition can be used as an interrupt signal to initiate the data readback controlled by the digital host. The AD4002/AD4006/AD4010 then enter the acquisition phase and power down. The data bits are then clocked out, MSB first, by subsequent  $\overline{SCK}$  falling edges. The data is valid on both  $\overline{SCK}$  edges. Although the rising edge can capture the data, a digital host using the  $\overline{SCK}$  falling edge allows a faster reading rate, provided it has an acceptable hold time. After the optional 19<sup>th</sup>  $\overline{SCK}$  falling edge or when  $\overline{SDI}$  goes high (whichever occurs first),  $\overline{SDO}$  returns to high impedance.

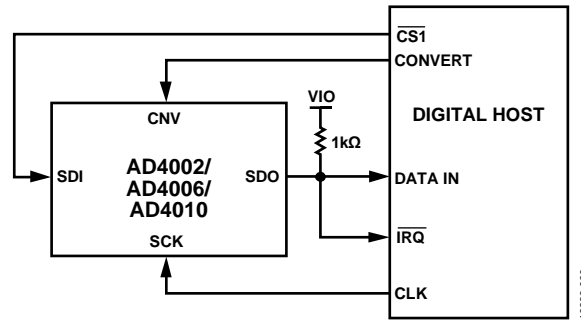

Figure 61.  $\overline{CS}$  Mode, 4-Wire with Busy Indicator Connection Diagram

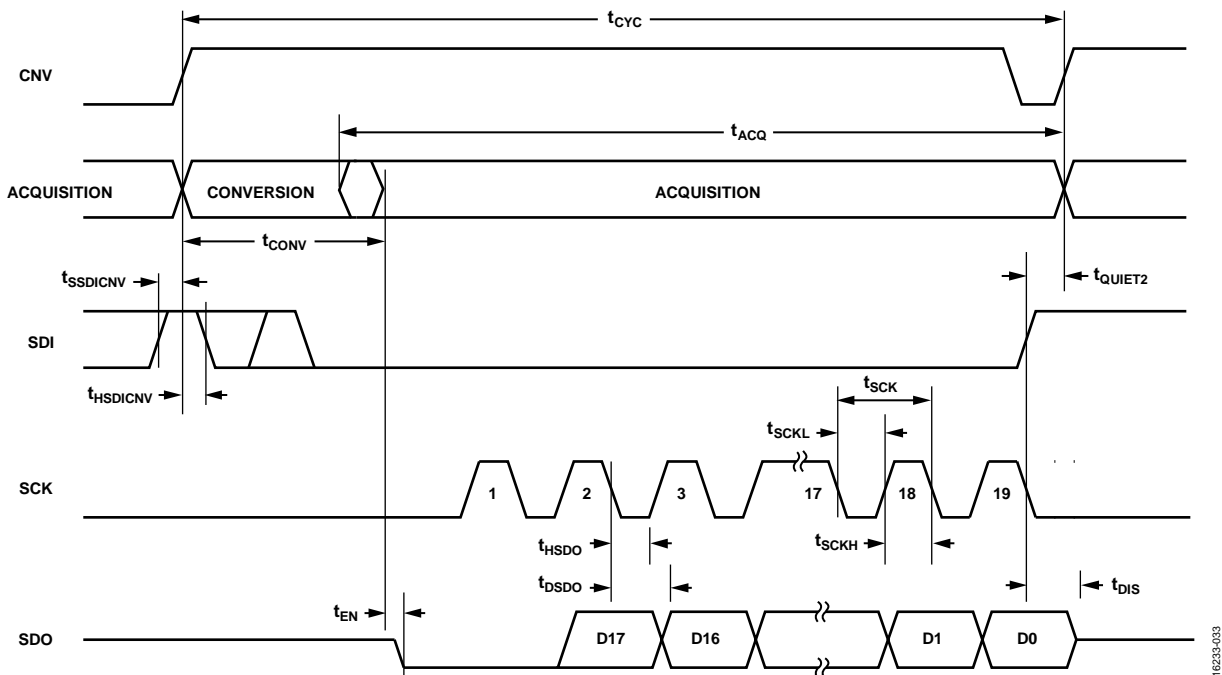

Figure 62.  $\overline{CS}$  Mode, 4-Wire with Busy Indicator Serial Interface Timing Diagram

**DAISY-CHAIN MODE**

Use this mode to daisy-chain multiple AD4002/AD4006/AD4010 devices on a 3-wire or 4-wire serial interface. This feature is useful for reducing component count and wiring connections, for example, in isolated multiconverter applications or for systems with a limited interfacing capacity. Data read back is analogous to clocking a shift register.

A connection diagram example using two AD4002/AD4006/AD4010 devices is shown in Figure 63, and the corresponding timing diagram is shown in Figure 64.

When SDI and CNV are low, SDO is driven low. With SCK low, a rising edge on CNV initiates a conversion, selects daisy-chain mode, and disables the busy indicator. In this mode, CNV is held high during the conversion phase and the subsequent data readback.

When the conversion is complete, the MSB is output onto SDO and the AD4002/AD4006/AD4010 enter the acquisition phase and power down. The remaining data bits stored in the internal shift register are clocked out of SDO by subsequent SCK falling edges. For each ADC, SDI feeds the input of the internal shift register and is clocked by the SCK rising edges. Each ADC in

the daisy-chain outputs its data MSB first, and  $18 \times N$  clocks are required to read back the N ADCs. The data is valid on both SCK edges. The maximum conversion rate is reduced because of the total readback time.

It is possible to write to each ADC register in daisy-chain mode. The timing diagram is shown in Figure 49. This mode requires 4-wire operation because data is clocked in on the SDI line with CNV held low. The same command byte and register data can be shifted through the entire chain to program all ADCs in the chain with the same register contents, which requires  $8 \times (N + 1)$  clocks for N ADCs. It is possible to write different register contents to each ADC in the chain by writing to the furthest ADC in the chain, first using  $8 \times (N + 1)$  clocks, and then the second furthest ADC with  $8 \times N$  clocks, and so forth until reaching the nearest ADC in the chain, which requires 16 clocks for the command and register data. It is not possible to read register contents in daisy-chain mode; however, the six status bits can be enabled if the user wants to determine the ADC configuration. Note that enabling the status bits requires six extra clocks to clock out the ADC result and the status bits per ADC in the chain. Turbo mode cannot be used in daisy-chain mode.

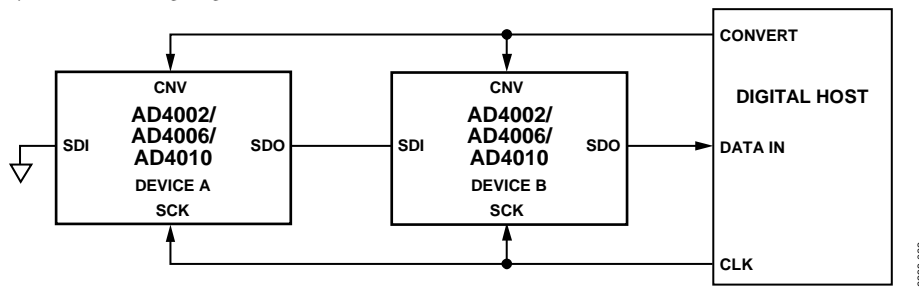

Figure 63. Daisy-Chain Mode, Connection Diagram

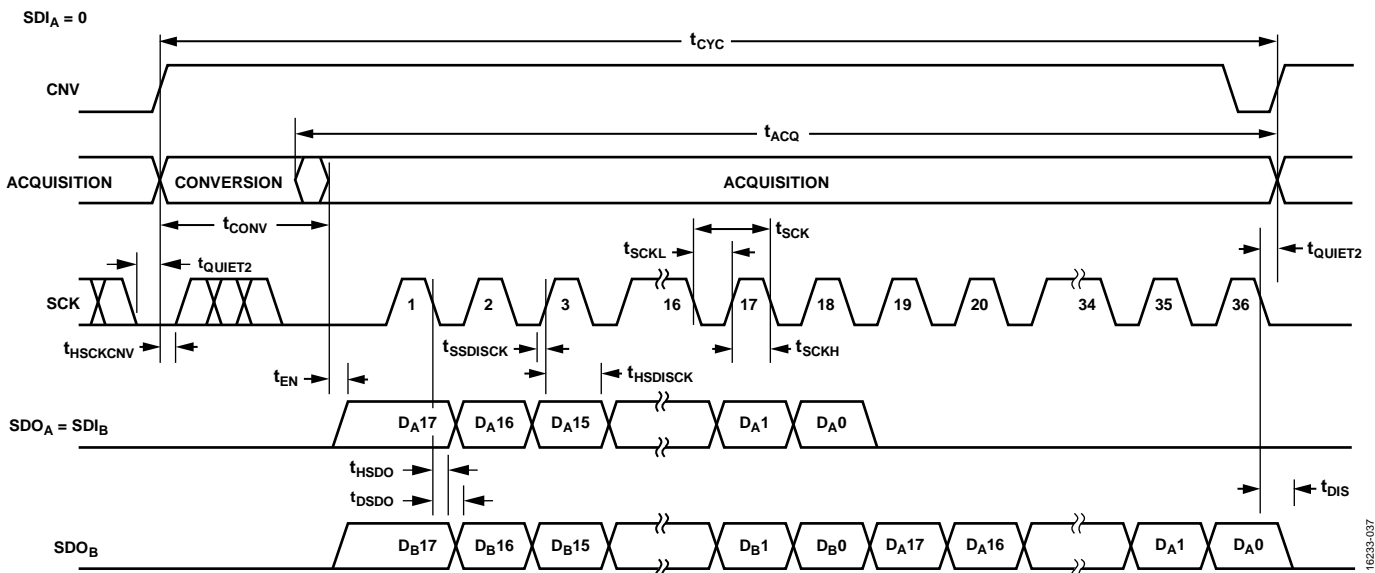

Figure 64. Daisy-Chain Mode, Serial Interface Timing Diagram

## LAYOUT GUIDELINES

The PCB that houses the AD4002/AD4006/AD4010 must be designed so that the analog and digital sections are separated and confined to certain areas of the board. The pinout of the AD4002/AD4006/AD4010, with its analog signals on the left side and its digital signals on the right side, eases this task.

Avoid running digital lines under the device because they couple noise onto the die, unless a ground plane under the AD4002/AD4006/AD4010 is used as a shield. Fast switching signals, such as CNV or clocks, must not run near analog signal paths. Avoid crossover of digital and analog signals.

At least one ground plane must be used. It can be common or split between the digital and analog sections. In the latter case, join the planes underneath the AD4002/AD4006/AD4010 devices.

The AD4002/AD4006/AD4010 voltage reference input (REF) has a dynamic input impedance. Decouple the REF pin with minimal parasitic inductances by placing the reference decoupling ceramic capacitor close to (ideally right up against) the REF and GND pins and connect them with wide, low impedance traces.

Finally, decouple the VDD and VIO power supplies of the AD4002/AD4006/AD4010 with ceramic capacitors, typically 0.1  $\mu\text{F}$ , placed close to the AD4002/AD4006/AD4010 and connected using short, wide traces to provide low impedance paths and to reduce the effect of glitches on the power supply lines.

An example of the AD4002 layout following these rules is shown in Figure 65 and Figure 66. Note that the AD4006/AD4010 layout is equivalent to the AD4002 layout.

## EVALUATING THE AD4002/AD4006/AD4010 PERFORMANCE

Other recommended layouts for the AD4002/AD4006/AD4010 are outlined in the user guide of the evaluation board for the AD4002 ([EVAL-AD4002FMCZ](#)). The evaluation board package includes a fully assembled and tested evaluation board with the AD4002, documentation, and software for controlling the board from a PC via the [EVAL-SDP-CH1Z](#). The [EVAL-AD4002FMCZ](#) can also be used to evaluate the AD4006/AD4010 by limiting the throughput to 1 MSPS/500 kSPS in its software (see [UG-1042](#)).

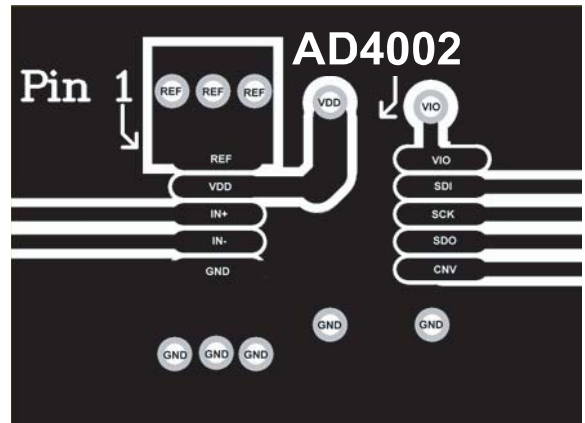

Figure 65. Example Layout of the AD4002 (Top Layer)

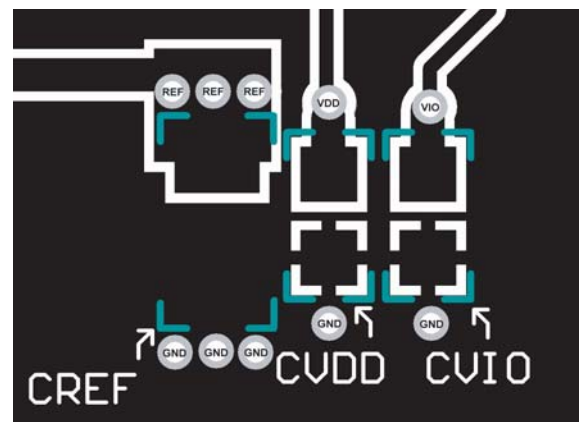
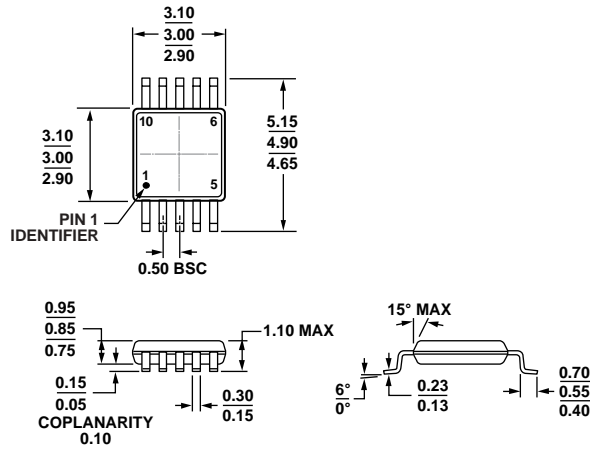

Figure 66. Example Layout of the AD4002 (Bottom Layer)

OUTLINE DIMENSIONS



COMPLIANT TO JEDEC STANDARDS MO-187-BA  
 Figure 67. 10-Lead Mini Small Outline Package [MSOP]  
 (RM-10)  
 Dimensions shown in millimeters

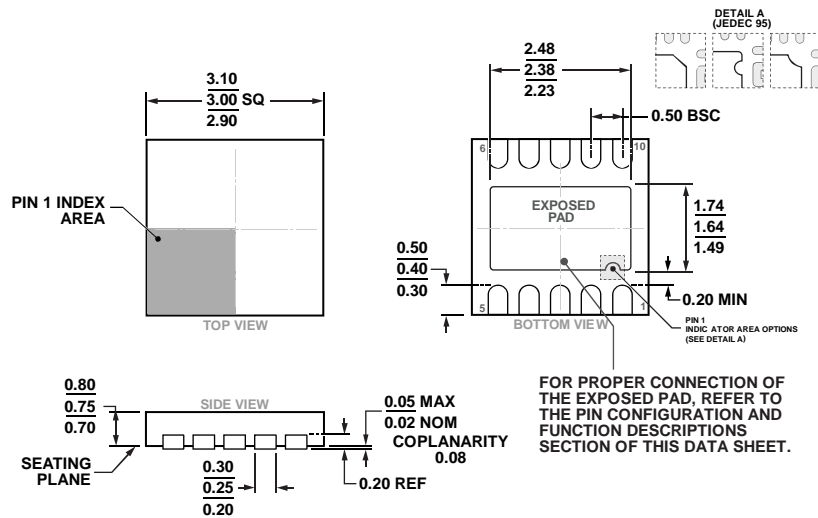

Figure 68. 10-Lead Lead Frame Chip Scale Package [LFCSF]  
 3 mm x 3 mm Body and 0.75 mm Package Height  
 (CP-10-9)  
 Dimensions shown in millimeters

ORDERING GUIDE

Model <sup>1, 2</sup>	Integral Nonlinearity (INL)	Temperature Range	Package Description	Ordering Quantity	Package Option	Marking Codes
AD4002BRMZ	±3.2 LSB	-40°C to +125°C	10-Lead MSOP, Tube	50	RM-10	C8E
AD4002BRMZ-RL7	±3.2 LSB	-40°C to +125°C	10-Lead MSOP, Reel	1000	RM-10	C8E
AD4002BCPZ-RL7	±3.2 LSB	-40°C to +125°C	10-Lead LFCSP, Reel	1500	CP-10-9	C8E
AD4006BRMZ	±3.2 LSB	-40°C to +125°C	10-Lead MSOP, Tube	50	RM-10	C8Q
AD4006BRMZ-RL7	±3.2 LSB	-40°C to +125°C	10-Lead MSOP, Reel	1000	RM-10	C8Q
AD4006BCPZ-RL7	±3.2 LSB	-40°C to +125°C	10-Lead LFCSP, Reel	1500	CP-10-9	C8Q
AD4010BCPZ-RL7	±3.2 LSB	-40°C to +125°C	10-Lead LFCSP, Reel	1500	CP-10-9	C8U
EVAL-AD4002FMCZ			AD4002 Evaluation Board compatible with EVAL-SDP-CH1Z			

<sup>1</sup> Z = RoHS Compliant Part.

<sup>2</sup> The EVAL-AD4002FMCZ can also be used to evaluate the AD4006 and AD4010 by limiting the throughput to 1 MSPS and 500 kSPS in its software, respectively (see UG-1042).

## NOTES



Компания «ЭлектроПласт» предлагает заключение долгосрочных отношений при поставках импортных электронных компонентов на взаимовыгодных условиях!

Наши преимущества:

- Оперативные поставки широкого спектра электронных компонентов отечественного и импортного производства напрямую от производителей и с крупнейших мировых складов;
- Поставка более 17-ти миллионов наименований электронных компонентов;
- Поставка сложных, дефицитных, либо снятых с производства позиций;
- Оперативные сроки поставки под заказ (от 5 рабочих дней);
- Экспресс доставка в любую точку России;
- Техническая поддержка проекта, помощь в подборе аналогов, поставка прототипов;
- Система менеджмента качества сертифицирована по Международному стандарту ISO 9001;
- Лицензия ФСБ на осуществление работ с использованием сведений, составляющих государственную тайну;
- Поставка специализированных компонентов (Xilinx, Altera, Analog Devices, Intersil, Interpoint, Microsemi, Aeroflex, Peregrine, Syfer, Eurofarad, Texas Instrument, Miteq, Cobham, E2V, MA-COM, Hittite, Mini-Circuits, General Dynamics и др.);

Помимо этого, одним из направлений компании «ЭлектроПласт» является направление «Источники питания». Мы предлагаем Вам помощь Конструкторского отдела:

- Подбор оптимального решения, техническое обоснование при выборе компонента;
- Подбор аналогов;
- Консультации по применению компонента;
- Поставка образцов и прототипов;
- Техническая поддержка проекта;
- Защита от снятия компонента с производства.



#### Как с нами связаться

**Телефон:** 8 (812) 309 58 32 (многоканальный)

**Факс:** 8 (812) 320-02-42

**Электронная почта:** [org@eplast1.ru](mailto:org@eplast1.ru)

**Адрес:** 198099, г. Санкт-Петербург, ул. Калинина, дом 2, корпус 4, литера А.