

TINA2-RS

~14° spot beam. Assembly with holder, installation tape and location pins.

TECHNICAL SPECIFICATIONS:

Dimensions	Ø 16.0 mm
Height	9.5 mm
Fastening	tape, pin
ROHS compliant	yes ⓘ

MATERIAL SPECIFICATIONS:

Component	Type	Material	Colour	Finish
TINA2-RS	Single lens	PMMA	clear	
TINA2-HLD-BLK	Holder	PC	black	
TINA-TAPE3	Tape	PU tape	black	



ORDERING INFORMATION:

Component		Qty in box	MOQ	MPQ	Box weight (kg)
CA12374_TINA2-RS	Single lens	4140	230	230	8.3
» Box size: 451 x 241 x 298 mm					

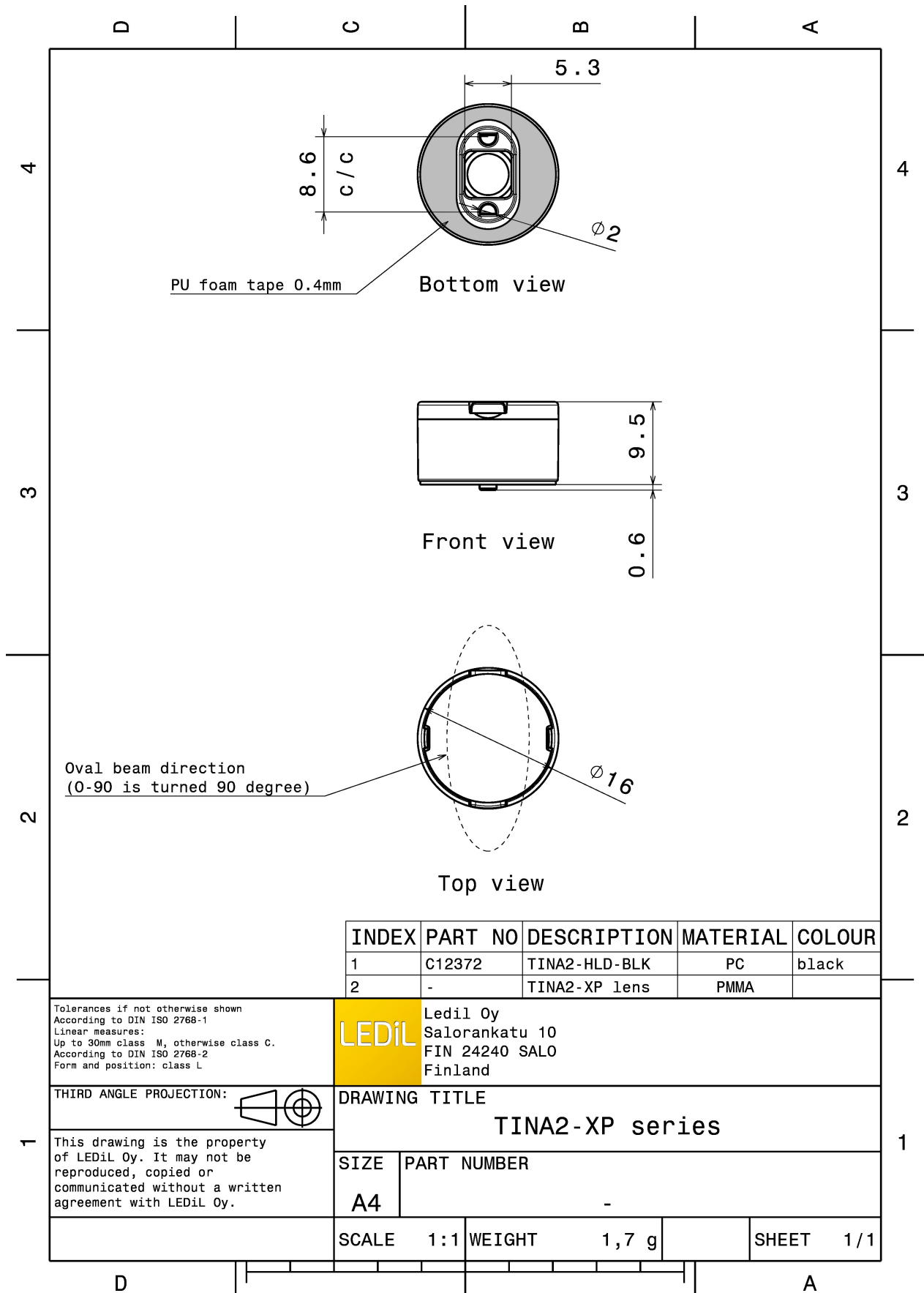

PHOTOMETRIC DATA (MEASURED):



LED XB-H
 FWHM 17.0°
 Efficiency 86 %
 Peak intensity 8.7 cd/lm
 LEDs/each optic 1
 Light colour White
 Required components:

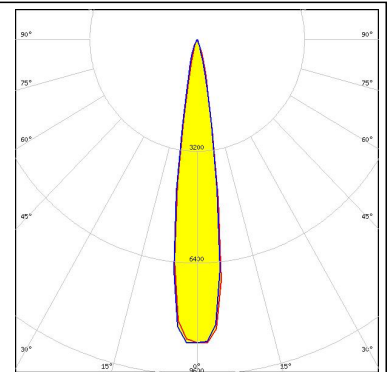

LED XQ-E HI
 FWHM 9.0°
 Efficiency 81 %
 Peak intensity 25 cd/lm
 LEDs/each optic 1
 Light colour White
 Required components:

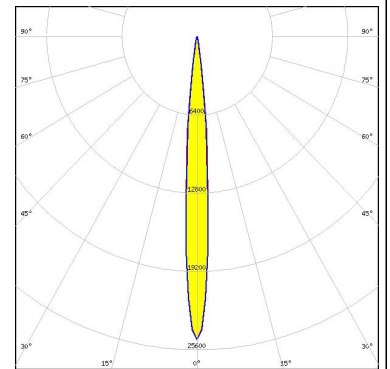

LED LUXEON TX
 FWHM 15.0°
 Efficiency 89 %
 Peak intensity 9.9 cd/lm
 LEDs/each optic 1
 Light colour White
 Required components:

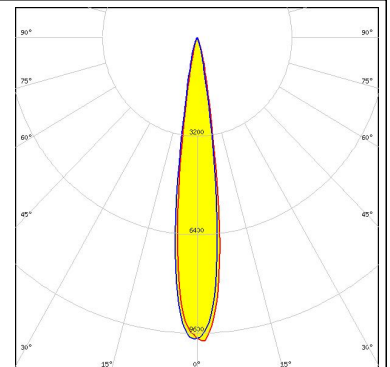
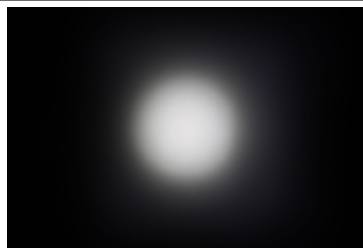

LED NVSxx19B/NVSxx19C
 FWHM 18.0°
 Efficiency 88 %
 Peak intensity 7 cd/lm
 LEDs/each optic 1
 Light colour White
 Required components:

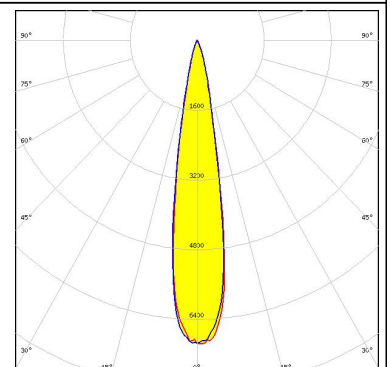

PHOTOMETRIC DATA (MEASURED):



LED NWSx229A
FWHM 25.0°
Efficiency 86 %
Peak intensity 3.6 cd/lm
LEDs/each optic 1
Light colour White
Required components:

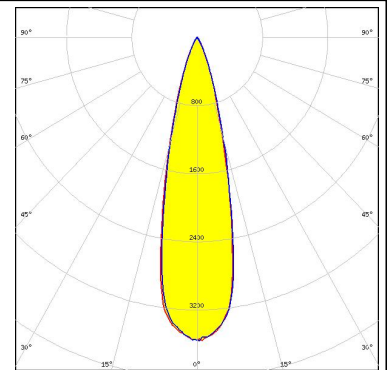

Osram Opto Semiconductors

LED OSOLON Square EC
FWHM 13.0°
Efficiency 88 %
Peak intensity 9.3 cd/lm
LEDs/each optic 1
Light colour White
Required components:



Osram Opto Semiconductors

LED OSOLON Square PC
FWHM 12.0°
Efficiency 88 %
Peak intensity 9.2 cd/lm
LEDs/each optic 1
Light colour White
Required components:



Osram Opto Semiconductors

LED OSOLON SSL 150
FWHM 11.0°
Efficiency 90 %
Peak intensity 19.5 cd/lm
LEDs/each optic 1
Light colour White
Required components:

PHOTOMETRIC DATA (MEASURED):

OSRAM

Opto Semiconductors

LED OSLON SSL 80
FWHM 10.0°
Efficiency 88 %
Peak intensity 16 cd/lm
LEDs/each optic 1
Light colour White
Required components:

OSRAM

Opto Semiconductors

LED SFH 4180S
FWHM 6.0°
Efficiency %
LEDs/each optic 1
Light colour IR
Required components:

OSRAM

Opto Semiconductors

LED SFH 4715S
FWHM 14.0°
Efficiency %
LEDs/each optic 1
Light colour White
Required components:

OSRAM

Opto Semiconductors

LED SFH 4716S
FWHM 11.0°
Efficiency %
LEDs/each optic 1
Light colour White
Required components:

PHOTOMETRIC DATA (MEASURED):



PHOTOMETRIC DATA (SIMULATED):

LUMILEDS

LED LUXEON C
 FWHM 11.0°
 Efficiency 92 %
 Peak intensity 14 cd/lm
 LEDs/each optic 1
 Light colour White
 Required components:

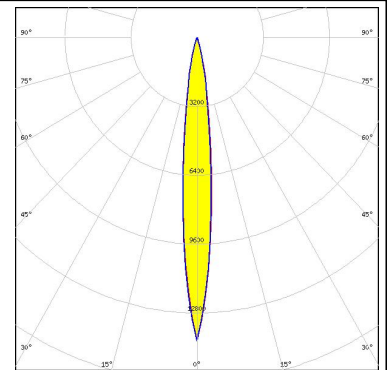

LUMILEDS

LED LUXEON IR Compact
 FWHM 10.0°
 Efficiency 87 %
 LEDs/each optic 1
 Light colour IR
 Required components:

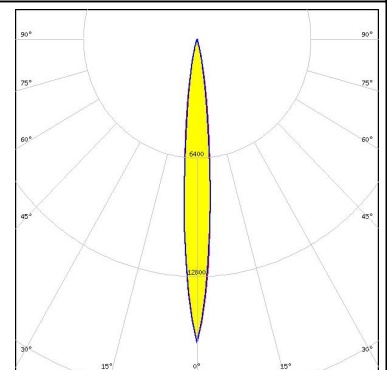

NICHIA

LED NFSx757G
 FWHM 10.0°
 Efficiency 93 %
 Peak intensity 16.7 cd/lm
 LEDs/each optic 1
 Light colour White
 Required components:

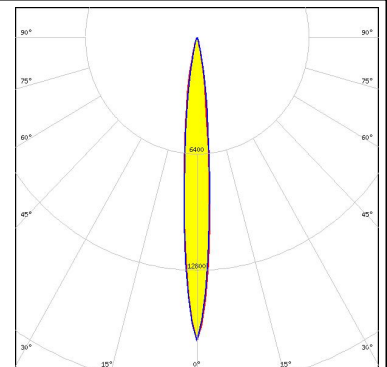

OSRAM Opto Semiconductors

LED OSCONIQ P 3030
 FWHM 12.0°
 Efficiency 91 %
 Peak intensity 16 cd/lm
 LEDs/each optic 1
 Light colour Blue
 Required components:

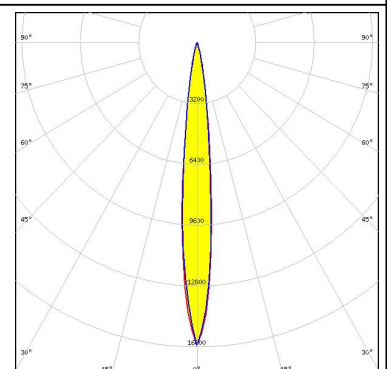

PHOTOMETRIC DATA (SIMULATED):

OSRAM
Opto Semiconductors

LED OSLON Black Flat
 FWHM 8.6°
 Efficiency 92 %
 Peak intensity 32.4 cd/lm
 LEDs/each optic 1
 Light colour White
 Required components:

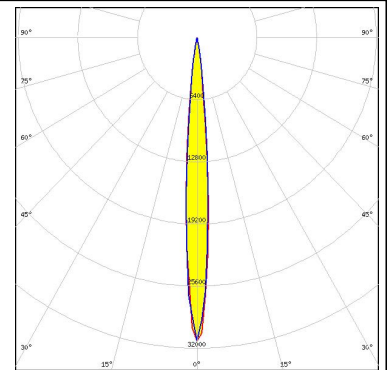

OSRAM
Opto Semiconductors

LED OSLON Square Flat
 FWHM 11.0°
 Efficiency 91 %
 Peak intensity 16.4 cd/lm
 LEDs/each optic 1
 Light colour White
 Required components:

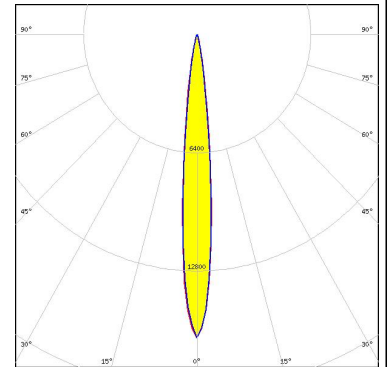

OSRAM
Opto Semiconductors

LED SFH 4170S
 FWHM 10.0°
 Efficiency 81 %
 LEDs/each optic 1
 Light colour IR
 Required components:

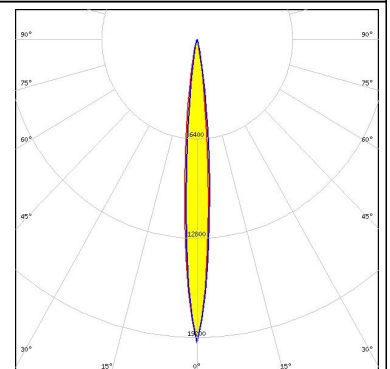

OSRAM
Opto Semiconductors

LED SFH 4770S
 FWHM 13.0°
 Efficiency 92 %
 LEDs/each optic 1
 Light colour IR
 Required components:

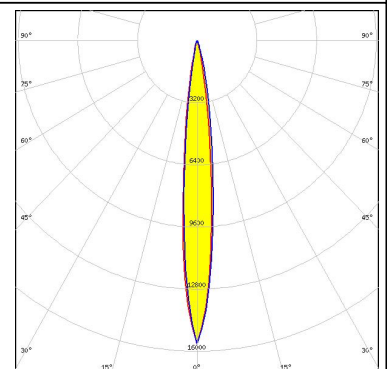

PHOTOMETRIC DATA (SIMULATED):

OSRAM
Opto Semiconductors

LED Synios P2720 1 mm
 FWHM 10.0°
 Efficiency 92 %
 Peak intensity 20.3 cd/lm
 LEDs/each optic 1
 Light colour White
 Required components:

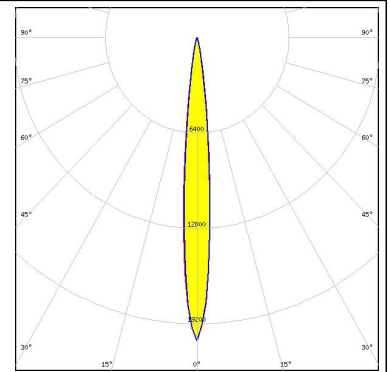

OSRAM
Opto Semiconductors

LED Synios P2720 1/2 mm
 FWHM 9.0°
 Efficiency 92 %
 Peak intensity 24 cd/lm
 LEDs/each optic 1
 Light colour White
 Required components:

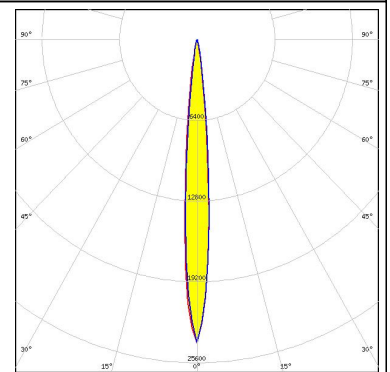

OSRAM
Opto Semiconductors

LED Synios P2720 1/4 mm
 FWHM 8.0°
 Efficiency 92 %
 Peak intensity 27.5 cd/lm
 LEDs/each optic 1
 Light colour White
 Required components:

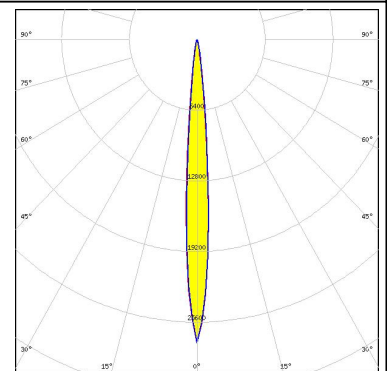

GENERAL INFORMATION:

NOTE: The typical beam angle will be changed by different color, chip size and chip position tolerance. The typical total beam angle is the full angle measured where the luminous intensity is half of the peak value.

MATERIALS:

As part of our continuous research and improvement processes, and to ensure the best possible quality and availability of our products, LEDiL reserves the right to change material grades without notice.

PRODUCT DATA USER AGREEMENT AND DISCLAIMER:

The measured data in the provided downloadable LEDiL Product Datasheets and Mechanical 2D-Drawings is rounded and provided as reference for planning. LEDiL Oy's optical specifications have been verified by conducting performance testing of the products in accordance with the company's quality system. The reported data are averaged results of multiple measurements with typical variation. LEDiL Oy reserves the right to without prior notification make changes and improvements to its products.

LEDiL Oy assumes neither warranty, nor guarantee nor any other liability of any kind for the contents and correctness of the provided data. The provided data has been generated with highest diligence but the provided data may in reality not represent the complete possible variation range of all intrinsic parameters. Therefore, in certain cases a deviation from the provided data could occur.

LEDiL Oy reserves the right to undertake technical changes of its products without further notification which could lead to changes in the provided data. LEDiL Oy assumes no liability of any kind for the possible deviation from any provided data or any other damage resulting from the usage of the provided data.

The user agrees to this disclaimer and user agreement with the download or usage of the provided files.

LEDiL Oy

Joensuunkatu 13
FI-24240 SALO
Finland

LEDiL Inc.

228 West Page Street
Suite D
Sycamore IL 60178
USA

Local sales and technical support

[www.ledil.com/
where_to_buy](http://www.ledil.com/where_to_buy)

Shipping locations

Salo, Finland
Hong Kong, China

Distribution Partners

[www.ledil.com/
where_to_buy](http://www.ledil.com/where_to_buy)



Компания «ЭлектроПласт» предлагает заключение долгосрочных отношений при поставках импортных электронных компонентов на взаимовыгодных условиях!

Наши преимущества:

- Оперативные поставки широкого спектра электронных компонентов отечественного и импортного производства напрямую от производителей и с крупнейших мировых складов;
- Поставка более 17-ти миллионов наименований электронных компонентов;
- Поставка сложных, дефицитных, либо снятых с производства позиций;
- Оперативные сроки поставки под заказ (от 5 рабочих дней);
- Экспресс доставка в любую точку России;
- Техническая поддержка проекта, помощь в подборе аналогов, поставка прототипов;
- Система менеджмента качества сертифицирована по Международному стандарту ISO 9001;
- Лицензия ФСБ на осуществление работ с использованием сведений, составляющих государственную тайну;
- Поставка специализированных компонентов (Xilinx, Altera, Analog Devices, Intersil, Interpoint, Microsemi, Aeroflex, Peregrine, Syfer, Eurofarad, Texas Instrument, Miteq, Cobham, E2V, MA-COM, Hittite, Mini-Circuits, General Dynamics и др.);

Помимо этого, одним из направлений компании «ЭлектроПласт» является направление «Источники питания». Мы предлагаем Вам помощь Конструкторского отдела:

- Подбор оптимального решения, техническое обоснование при выборе компонента;
- Подбор аналогов;
- Консультации по применению компонента;
- Поставка образцов и прототипов;
- Техническая поддержка проекта;
- Защита от снятия компонента с производства.



Как с нами связаться

Телефон: 8 (812) 309 58 32 (многоканальный)

Факс: 8 (812) 320-02-42

Электронная почта: org@eplast1.ru

Адрес: 198099, г. Санкт-Петербург, ул. Калинина, дом 2, корпус 4, литера А.