



# 20MHz to 134MHz Spread-Spectrum Clock Modulator for LCD Panels

## General Description

The DS1081L is a spread-spectrum clock modulator IC that reduces EMI in high clock-frequency-based, digital electronic equipment.

Using an integrated phase-locked loop (PLL), the DS1081L accepts an input clock signal in the range of 20MHz to 134MHz and delivers a spread-spectrum modulated output clock signal. The PLL modulates, or dithers, the output clock about the center input frequency at a pin-selectable magnitude and dither rate, allowing direct EMI control and optimization. In addition, through an enable pin the dithering can be enabled or disabled for easy comparison of system performance during EMI testing. This same input pin also allows the DS1081L output to be three-stated.

By dithering the system clock, all the address, data, and timing signals generated from this signal are also dithered so that the measured EMI at the fundamental and harmonic frequencies is greatly reduced. This is accomplished without changing clock rise/fall times or adding the space, weight, design time, and cost associated with mechanical shielding.

The DS1081L is provided in an 8-pin TSSOP package and operates over a full automotive temperature range of -40°C to +125°C.

## Applications

LCD Panels for TVs, Desktop Monitors, and Notebook and Tablet PCs

Automotive Telematics and Infotainment

Printers

Typical Operating Circuit appears at end of data sheet.

## Block Diagram

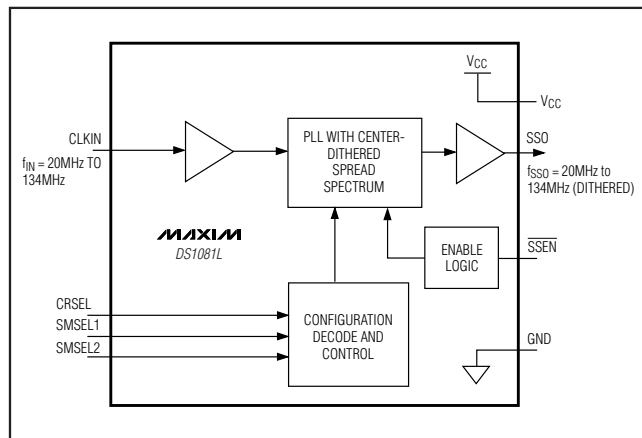

## Features

- ◆ Modulates a 20MHz to 134MHz Clock with Center Spread-Spectrum Dithering
- ◆ Selectable Spread-Spectrum Modulation Magnitudes of:
  - ±0.5%
  - ±1.0%
  - ±1.5%
  - ±2.0%
- ◆ Low 75ps Cycle-to-Cycle Jitter
- ◆ Spread-Spectrum Disable Mode
- ◆ Pin Compatible with Alliance/PulseCore Semiconductor P2040 Series Devices
- ◆ Clock Output Disable
- ◆ Low Power Consumption
- ◆ 3.3V Single Voltage Supply
- ◆ -40°C to +125°C Temperature Range
- ◆ Small 8-Pin TSSOP Package

## Ordering Information

PART	TEMP RANGE	PIN-PACKAGE
DS1081LE+	-40°C to +125°C	8 TSSOP
DS1081LE+T	-40°C to +125°C	8 TSSOP

+ Denotes a lead (Pb)-free/RoHS-compliant package.  
T = Tape and reel.

## Pin Configuration

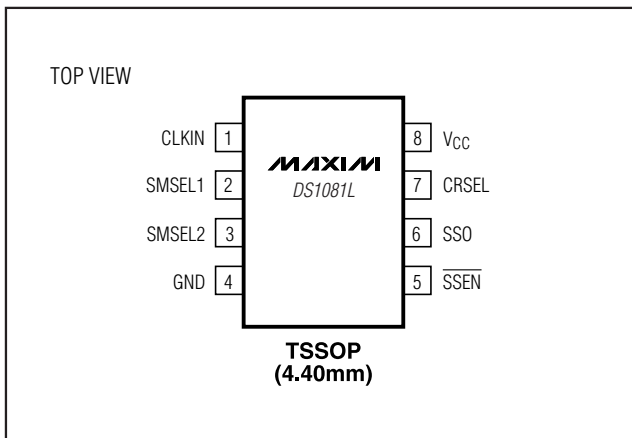

DS1081L

# 20MHz to 134MHz Spread-Spectrum Clock Modulator for LCD Panels

## ABSOLUTE MAXIMUM RATINGS

Voltage Range on  $V_{CC}$  Relative to GND .....-0.5V to +3.63V  
 Voltage Range on Any Pin Relative to GND .....-0.5V to ( $V_{CC} + 0.5V$ ), not to exceed +3.63V  
 Operating Temperature Range .....-40°C to +125°C

Continuous Power Dissipation ( $T_A = +70^\circ\text{C}$ )  
 TSSOP (derate 8.1mW/°C above +70°C) .....646.7mW  
 Storage Temperature Range .....-55°C to +125°C  
 Lead Temperature (soldering, 10s) .....+300°C  
 Soldering Temperature (reflow) .....+260°C

Stresses beyond those listed under "Absolute Maximum Ratings" may cause permanent damage to the device. These are stress ratings only, and functional operation of the device at these or any other conditions beyond those indicated in the operational sections of the specifications is not implied. Exposure to absolute maximum rating conditions for extended periods may affect device reliability.

## RECOMMENDED OPERATING CONDITIONS

( $T_A = -40^\circ\text{C}$  to +125°C, unless otherwise noted.)

PARAMETER	SYMBOL	CONDITIONS	MIN	TYP	MAX	UNITS
Supply Voltage	$V_{CC}$	(Note 1)	3.0		3.6	V
Input Logic 1	$V_{IH}$		0.8 x $V_{CC}$		$V_{CC} + 0.3$	V
Input Logic 0	$V_{IL}$		-0.3		0.2 x $V_{CC}$	V
Input Logic Open ( $\overline{SSEN}$ , CRSEL)	$I_{OPEN}$	0V < (Voltage applied to $\overline{SSEN}$ or CRSEL) < $V_{CC}$			±1	μA
SSO Load	$C_L$	SSO < 80MHz			15	pF
		80MHz ≤ SSO < 134MHz			7	
CLKIN Frequency	$f_{IN}$		20		134	MHz
CLKIN Duty Cycle	$f_{INDC}$		40		60	%

## DC ELECTRICAL CHARACTERISTICS

( $V_{CC} = +3.0V$  to +3.6V,  $T_A = -40^\circ\text{C}$  to +125°C, unless otherwise noted.)

PARAMETER	SYMBOL	CONDITIONS	MIN	TYP	MAX	UNITS
Supply Current	$I_{CC}$	$C_L = 7\text{pF}$ $f_{IN} = 134\text{MHz}$			15	mA
SMSSEL1/SMSSEL2/CLKIN Input Leakage	$I_{IL:1}$	0V < $V_{IN} < V_{CC}$	-1		+1	μA
CRSEL/ $\overline{SSEN}$ Input Leakage	$I_{IL:2}$	0V < $V_{IN} < V_{CC}$	-100		+100	μA
Output Leakage (SSO)	$I_{OZ}$	$\overline{SSEN} = \text{open}$	-1		+1	μA
Low-Level Output Voltage (SSO)	$V_{OL}$	$I_{OL} = 4\text{mA}$			0.4	V
High-Level Output Voltage (SSO)	$V_{OH}$	$I_{OH} = -4\text{mA}$	2.4			V

## AC ELECTRICAL CHARACTERISTICS

( $V_{CC} = +3.0V$  to +3.6V,  $T_A = -40^\circ\text{C}$  to +125°C, unless otherwise noted.)

PARAMETER	SYMBOL	CONDITIONS	MIN	TYP	MAX	UNITS
SSO Duty Cycle	$f_{SSODC}$	Measured at $V_{CC}/2$	40		60	%
SSO Rise Time	$t_R$	$C_L = 7\text{pF}$		1		ns
SSO Fall Time	$t_F$	$C_L = 7\text{pF}$		1		ns
Peak Cycle-to-Cycle Jitter	$t_J$	$T_A = -40^\circ\text{C}$ to +85°C, 10,000 cycles		75		ps
Power-Up Time	$t_{POR}$	(Note 2)			50	ms

**Note 1:** All voltages referenced to ground. Currents into the IC are positive and out of the IC are negative.

**Note 2:** Time between power applied to device and stable output.

# 20MHz to 134MHz Spread-Spectrum Clock Modulator for LCD Panels

## Typical Operating Characteristics

( $T_A = +25^\circ\text{C}$ , unless otherwise noted.)

DS1081L

**SUPPLY CURRENT vs. SUPPLY VOLTAGE**

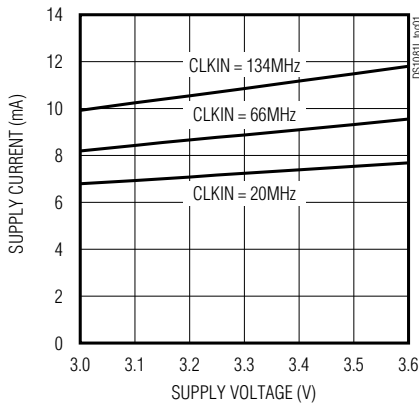

**SUPPLY CURRENT vs. TEMPERATURE**

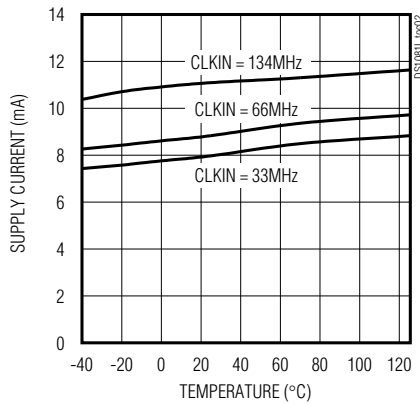

**SUPPLY CURRENT vs. FREQUENCY**

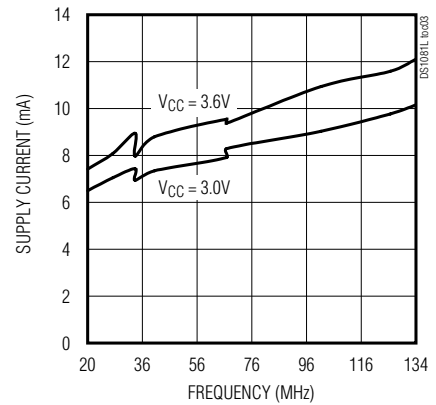

**DUTY CYCLE vs. TEMPERATURE**

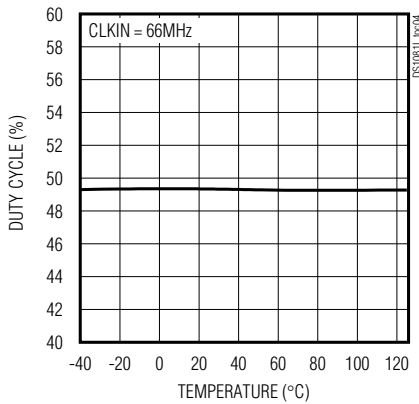

**DUTY CYCLE vs. SUPPLY VOLTAGE**

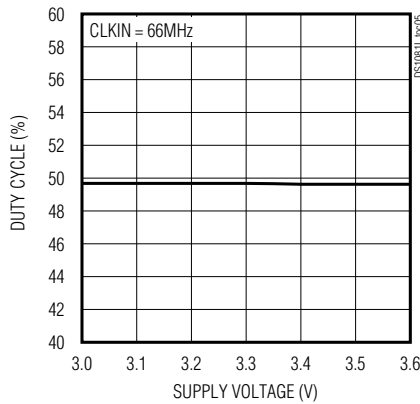

**SPECTRUM ATTENUATION vs. FREQUENCY AT DIFFERENT DITHER AMPLITUDES**

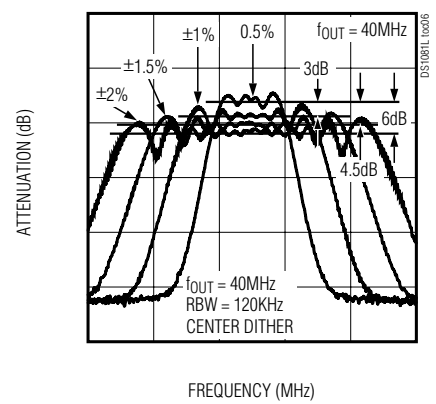

# 20MHz to 134MHz Spread-Spectrum Clock Modulator for LCD Panels

## Pin Description

PIN	NAME	FUNCTION													
1	CLKIN	Clock Input. 20MHz to 134MHz clock input ( $f_{IN}$ ).													
2	SMSEL1	Spread-Spectrum Magnitude Select Inputs. These digital inputs select the desired spread-spectrum magnitude as shown in the table below.													
		<table border="1"> <thead> <tr> <th>SMSEL2</th> <th>SMSEL1</th> <th>MAGNITUDE SELECTED</th> </tr> </thead> <tbody> <tr> <td>0</td> <td>0</td> <td><math>\pm 2.0\%</math></td> </tr> <tr> <td>0</td> <td>1</td> <td><math>\pm 1.5\%</math></td> </tr> <tr> <td>1</td> <td>0</td> <td><math>\pm 1.0\%</math></td> </tr> <tr> <td>1</td> <td>1</td> <td><math>\pm 0.5\%</math></td> </tr> </tbody> </table>	SMSEL2	SMSEL1	MAGNITUDE SELECTED	0	0	$\pm 2.0\%$	0	1	$\pm 1.5\%$	1	0	$\pm 1.0\%$	1
SMSEL2	SMSEL1	MAGNITUDE SELECTED													
0	0	$\pm 2.0\%$													
0	1	$\pm 1.5\%$													
1	0	$\pm 1.0\%$													
1	1	$\pm 0.5\%$													
3	SMSEL2														
4	GND	Ground													
5	$\overline{\text{SSEN}}$	Spread-Spectrum Enable. Three-level input to enable/disable spread-spectrum and to three-state the output. 0 = Power-up/spread-spectrum enabled. Open = SSO three-stated. 1 = Power-up/spread-spectrum disabled (not a bypass mode).													
6	SSO	Spread-Spectrum Clock Output. Outputs a center-dithered spread-spectrum version of the clock input at CLKIN.													
7	CRSEL	Clock Range and Dither Rate Select. Three-level input that determines the dither rate. See the <i>Detailed Description</i> section for details.													
		<table border="1"> <thead> <tr> <th>CRSEL</th> <th>CLKIN RANGE</th> <th>DITHER RATE</th> </tr> </thead> <tbody> <tr> <td>0</td> <td>66MHz to 134MHz</td> <td><math>f_{IN}/2048</math></td> </tr> <tr> <td>Open</td> <td>33MHz to 80MHz</td> <td><math>f_{IN}/1024</math></td> </tr> <tr> <td>1</td> <td>20MHz to 38MHz</td> <td><math>f_{IN}/512</math></td> </tr> </tbody> </table>	CRSEL	CLKIN RANGE	DITHER RATE	0	66MHz to 134MHz	$f_{IN}/2048$	Open	33MHz to 80MHz	$f_{IN}/1024$	1	20MHz to 38MHz	$f_{IN}/512$	
		CRSEL	CLKIN RANGE	DITHER RATE											
		0	66MHz to 134MHz	$f_{IN}/2048$											
Open	33MHz to 80MHz	$f_{IN}/1024$													
1	20MHz to 38MHz	$f_{IN}/512$													
8	VCC	Supply Voltage													

### Detailed Description

The DS1081L modulates an input clock to generate a center-dithered spread-spectrum output. A 20MHz to 134MHz clock is applied to the CLKIN pin. An internal PLL dithers the output clock about its center frequency at a user-selectable magnitude.

#### Spread-Spectrum Dither Magnitude

The DS1081L can generate dither magnitudes up to  $\pm 2\%$ . The desired magnitude is selected using input pins SMSEL1 and SMSEL2 as shown in Table 1.

**Table 1. Spread-Spectrum Dither Magnitude**

SMSEL2	SMSEL1	MAGNITUDE
0	0	$\pm 2.0\%$
0	1	$\pm 1.5\%$
1	0	$\pm 1.0\%$
1	1	$\pm 0.5\%$

#### Spread-Spectrum Dither Rate

The output spread-spectrum dither rate is determined by the input frequency to maximize EMI reduction and to ensure that the dither rate is always above the audio frequency range. The user must configure CRSEL, based on Table 2, depending on the input frequency ( $f_{IN}$ ) so that the appropriate dither rate is programmed.

**Table 2. Spread-Spectrum Dither Rate**

CRSEL	CLKIN RANGE	DITHER RATE
0	66MHz to 134MHz	$f_{IN}/2048$
Open	33MHz to 80MHz	$f_{IN}/1024$
1	20MHz to 38MHz	$f_{IN}/512$

# 20MHz to 134MHz Spread-Spectrum Clock Modulator for LCD Panels

DS1081L

## Spread-Spectrum Enable

On power-up, the output clock (SSO) remains three-stated until the internal PLL reaches a stable frequency. The  $\overline{\text{SSEN}}$  input can be used to disable the spread-spectrum modulation and to three-state the SSO output. If the  $\overline{\text{SSEN}}$  pin is pulled high, the spread-spectrum modulation is turned off, but the device still uses the internal PLL to generate the clock signal at SSO. If the  $\overline{\text{SSEN}}$  pin is open, the output is three-stated.

## Applications Information

### Power-Supply Decoupling

To achieve best results, it is highly recommended that a decoupling capacitor is used on the IC power-supply pins. Typical values of decoupling capacitors are 0.01 $\mu\text{F}$  and 0.1 $\mu\text{F}$ . Use a high-quality, ceramic, surface-mount capacitor, and mount it as close as possible to the  $V_{\text{CC}}$  and GND pins of the IC to minimize lead inductance.

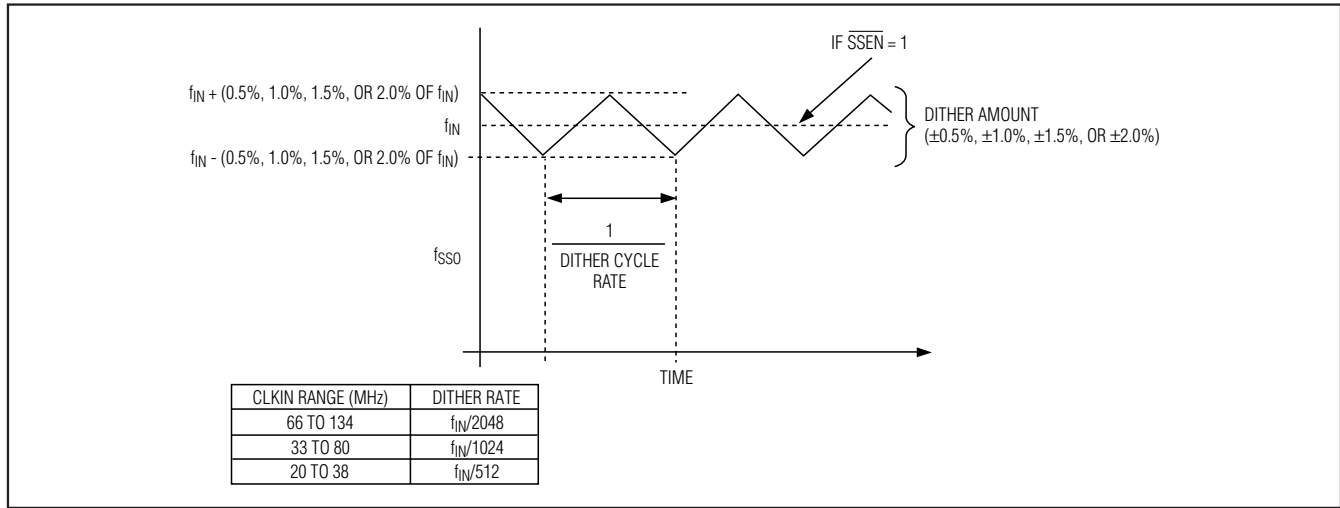
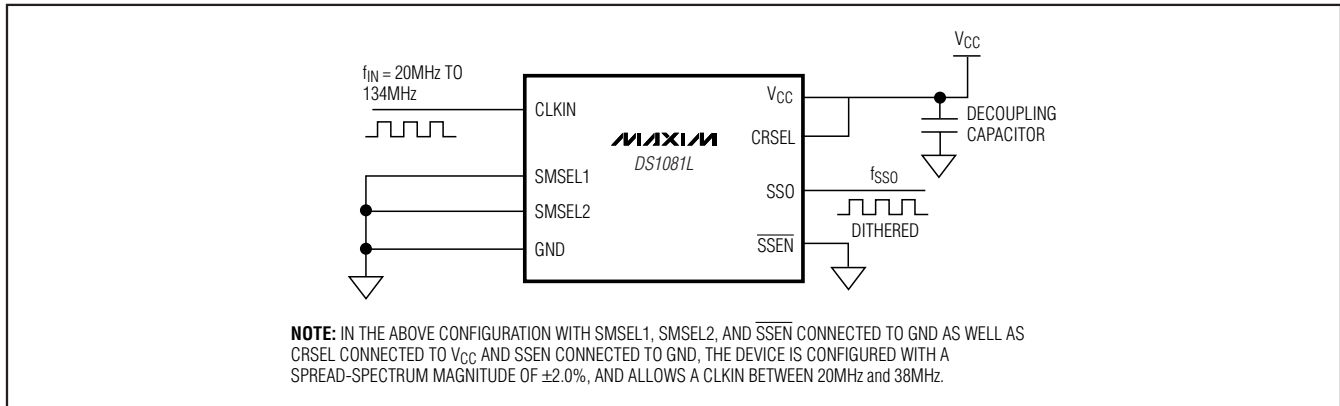

Figure 1. Spread-Spectrum Frequency Modulation

## Typical Operating Circuit



## Package Information

For the latest package outline information and land patterns (footprints), go to [www.maxim-ic.com/packages](http://www.maxim-ic.com/packages). Note that a "+", "#", or "-" in the package code indicates RoHS status only. Package drawings may show a different suffix character, but the drawing pertains to the package regardless of RoHS status.

PACKAGE TYPE	PACKAGE CODE	OUTLINE NO.	LAND PATTERN NO.
8 TSSOP	H8+3	<a href="#">21-0175</a>	<a href="#">90-0248</a>

# 20MHz to 134MHz Spread-Spectrum Clock Modulator for LCD Panels

## Revision History

REVISION NUMBER	REVISION DATE	DESCRIPTION	PAGES CHANGED
0	4/07	Initial release	—
1	10/11	Updated the <i>Absolute Maximum Ratings</i> , <i>Recommended Operating Conditions</i> , and <i>DC Electrical Characteristics</i> ; corrected pin number error in the <i>Pin Description</i> ; added the <i>Package Information</i> table	2, 4, 5

Maxim cannot assume responsibility for use of any circuitry other than circuitry entirely embodied in a Maxim product. No circuit patent licenses are implied. Maxim reserves the right to change the circuitry and specifications without notice at any time.

6 **Maxim Integrated Products, 120 San Gabriel Drive, Sunnyvale, CA 94086 408-737-7600**



Компания «ЭлектроПласт» предлагает заключение долгосрочных отношений при поставках импортных электронных компонентов на взаимовыгодных условиях!

Наши преимущества:

- Оперативные поставки широкого спектра электронных компонентов отечественного и импортного производства напрямую от производителей и с крупнейших мировых складов;
- Поставка более 17-ти миллионов наименований электронных компонентов;
- Поставка сложных, дефицитных, либо снятых с производства позиций;
- Оперативные сроки поставки под заказ (от 5 рабочих дней);
- Экспресс доставка в любую точку России;
- Техническая поддержка проекта, помощь в подборе аналогов, поставка прототипов;
- Система менеджмента качества сертифицирована по Международному стандарту ISO 9001;
- Лицензия ФСБ на осуществление работ с использованием сведений, составляющих государственную тайну;
- Поставка специализированных компонентов (Xilinx, Altera, Analog Devices, Intersil, Interpoint, Microsemi, Aeroflex, Peregrine, Syfer, Eurofarad, Texas Instrument, Miteq, Cobham, E2V, MA-COM, Hittite, Mini-Circuits, General Dynamics и др.);

Помимо этого, одним из направлений компании «ЭлектроПласт» является направление «Источники питания». Мы предлагаем Вам помощь Конструкторского отдела:

- Подбор оптимального решения, техническое обоснование при выборе компонента;
- Подбор аналогов;
- Консультации по применению компонента;
- Поставка образцов и прототипов;
- Техническая поддержка проекта;
- Защита от снятия компонента с производства.



#### Как с нами связаться

**Телефон:** 8 (812) 309 58 32 (многоканальный)

**Факс:** 8 (812) 320-02-42

**Электронная почта:** [org@eplast1.ru](mailto:org@eplast1.ru)

**Адрес:** 198099, г. Санкт-Петербург, ул. Калинина, дом 2, корпус 4, литера А.