

# K12 High Performance Key Switches

## Features/Benefits

- Excellent tactile feel
- Wide choice of LED colors, travel and actuator forces
- High reliability / long life
- Sealed version available
- Designed for low-level switching
- Double stroke version available
- Detector version available

## Typical Applications

- Automotive
- Off-road transportation
- Industrial electronics
- Computers & network equipment
- Joysticks



## Construction:

FUNCTION: momentary  
 DISTANCE BETWEEN BUTTON CENTERS:  
 min. 11 (0.433) K12C = 13 (0.512)  
 TERMINALS: PC pins, tinned  
 MOUNTING: Locating pins; K12G and K12P additionally  
 with snap-in housing

## Mechanical

TOTAL TRAVEL: 1 mm, 1.5 mm, 2 mm  
 SWITCHING TRAVEL: 0.6 mm\*  
 OPERATING FORCE: 1.5 N OD without snap-point as detector  
 switch, 2.5 N, 3.5 N, 5 N, 3.5/7 N, 6/12 N. Additional  
 operating force 7N, 9N and 20N, available on request.  
 PROTECTION CLASS: K12C IP 67 (dust tight, protected against  
 the effects of immersion in water; other versions IP 40)

\* Additional switching travel (with pre-travel) available by request.

## Packaging

Bulk in boxes of 250 pieces (version C or GO) or  
 300 pieces (version A, AL, P or PL)

## Electrical

SWITCHING POWER MIN./MAX.: 0.02mW/3 W  
 SWITCHING VOLTAGE MIN./MAX.: 2 V DC / 30 V DC  
 SWITCHING CURRENT MIN./MAX.: 10 mA /100 mA  
 DIELECTRIC STRENGTH (50 Hz, 1 min): ≥ 500 V  
 OPERATING LIFE with max. switching power: ≥ 10<sup>6</sup> operations  
 K12G & K12GO; operating life of second switch 5 x 10<sup>4</sup> operations,  
 operating life K12C and version with more than 6N (7N, 9N 20N)  
 please consult factory.  
 CONTACT RESISTANCE: Initial ≤ 50 mΩ  
 INSULATION RESISTANCE: ≥ 10<sup>10</sup> Ω  
 BOUNCE TIME: ≤ 1 ms  
 Operating speed 100 mm/s (3.94/s)

## Environmental

OPERATING TEMPERATURE: -40°C to 85°C.  
 STORAGE TEMPERATURE: -40°C to 95°C.

## Process

SOLDERABILITY:  
 Wave soldering, compatible with lead free soldering profile  
 Hand soldering, 350°C

## How To Order

Our easy build-a-switch concept allows you to mix and match options to create the switch you need. To order, select desired option from each category and place it in the appropriate box.

Note: Some of the configurations may not be available or could require some development.

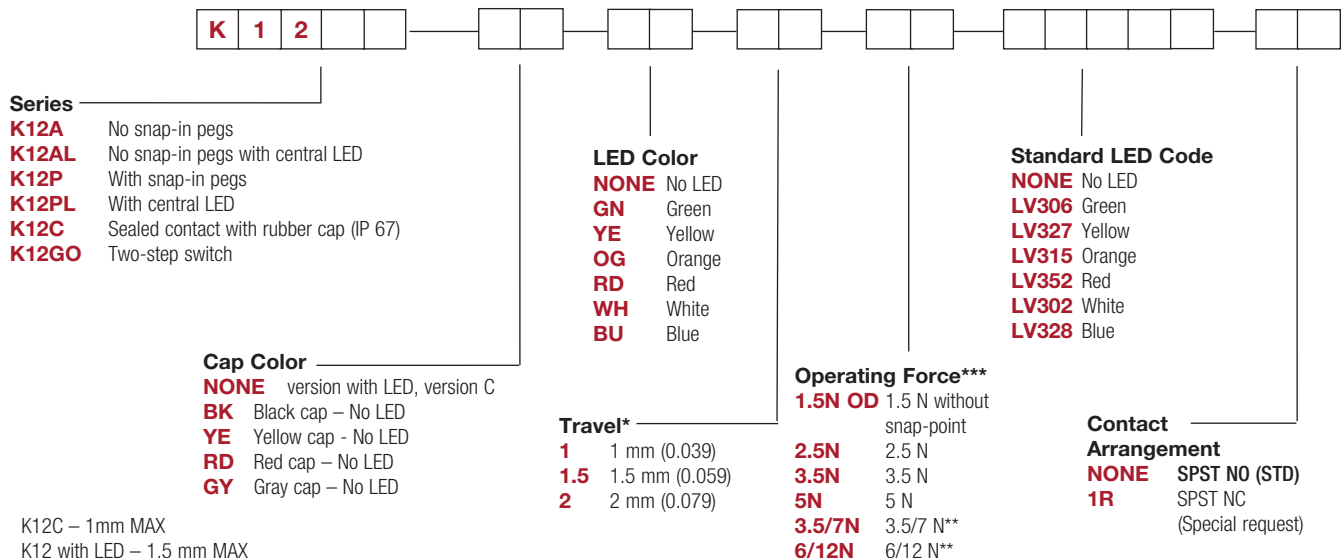

\* K12C – 1mm MAX

K12 with LED – 1.5 mm MAX

\*\* K12G & K12GO version only

\*\*\* Additional operating force: 7N, 9N available on request

# K12 High Performance Key Switches

SERIES

**K12A** without snap in

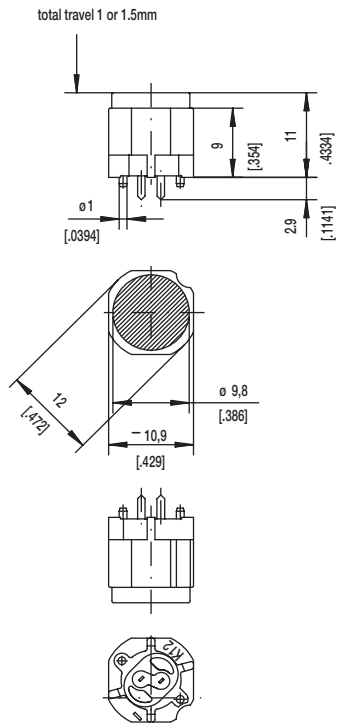

PCB LAYOUT, MOUNTING SIDE

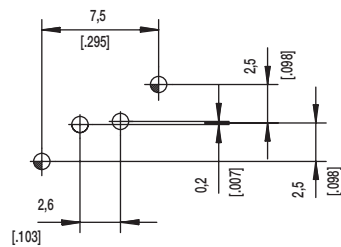

**K12AL**



PCB LAYOUT, MOUNTING SIDE

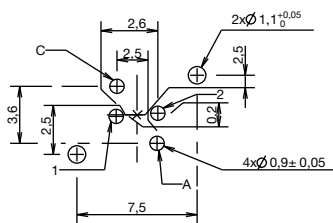

ELECTRICAL GRAPH

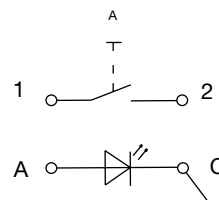

	1,1 <sup>+0,05</sup>	2x	2x	center hole		
	0,9 ±0,05		2x	LED	∅0,5 (.020)	Sn
		2x	2x	switch	0,7x0,2 (.028x.081)	Sn
Hole	∅	Without	with LED	Description	Terminal Section	Surface

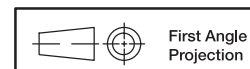

First Angle  
Projection

Dimensions are shown: mm  
Specifications and dimensions subject to change

# K12 High Performance Key Switches

SERIES

## K12P with snap in



### PCB LAYOUT, MOUNTING SIDE

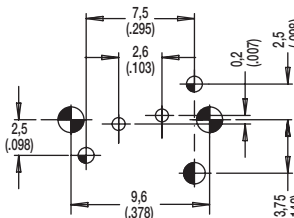

center of actuation area (notice LED)

Hole	Ø	Without LED	Description	Terminal Section	Surface
	1,7 (.069)	2x	snap-in		
	1,6 (.062)	1x	coding hole (L,M,N)		
	1,1 (.043)	2x	center hole		Sn
	0,9 (.035)	2x	switch	0.7 x 0.2 (.028 x .081)	Sn

## K12PL



### PCB LAYOUT, MOUNTING SIDE



### ELECTRICAL GRAPH



Hole	Ø	Without LED	Description	Terminal Section	Surface
	1,7 (.069)	2x	snap-in		
	1,6 (.062)	1x	coding hole (L,M,N)		
	1,1 (.043)	2x	center hole		Sn
	0,9 (.035)	2x	LED	m0.5 (.020)	Sn
	0,9 (.035)	2x	switch	0.7 x 0.2 (.028 x .081)	Sn



First Angle Projection



# K12 High Performance Key Switches

SERIES

**K12C** SEALED CONTACT WITH RUBBER CAP (IP 67)



PCB LAYOUT, MOUNTING SIDE



Hole	Ø	Without LED	Description	Terminal Section	Surface
	1,1 (.043)	2x	center hole		
	0,9 (.035)	2x	switch	0.7 x 0.2(.0275 x .0787)	Sn



D

Key Switches



First Angle  
Projection

Dimensions are shown: mm  
Specifications and dimensions subject to change

# K12 High Performance Key Switches

SERIES

## K12GO



PCB LAYOUT, MOUNTING SIDE



Hole	Ø	Without LED	Description	Terminal Section	Surface
	1,7 (.069)	2x	snap-in		
	1,6 (.062)	1x	code		
	0,9 (.035)		LED	m0.5 (.020)	Sn
		2x	switch 2	0.7 x 0.3 (.028 x .012)	Sn
		2x	switch 1	0.7 x 0.2 (.028 x .081)	Sn



Dimensions are shown: mm  
Specifications and dimensions subject to change

# K12 High Performance Key Switches

## CAP COLOR

OPTION CODE	COLOR
<b>NONE</b>	Version with LED
<b>BK</b>	Black - no LED
<b>YE</b>	Yellow - no LED
<b>RD</b>	Red - no LED
<b>GY</b>	Gray - no LED

## LED COLOR

OPTION CODE	COLOR
<b>NONE</b>	Models without LED
<b>GN</b>	Green
<b>YE</b>	Yellow
<b>OG</b>	Orange
<b>RD</b>	Red
<b>WH</b>	White
<b>BU</b>	Blue

STANDARD LED CODE	COLOR
<b>NONE</b>	Models without LED
<b>LV306</b>	Green
<b>LV327</b>	Yellow
<b>LV315</b>	Orange
<b>LV352</b>	Red
<b>LV302</b>	White
<b>LV328</b>	Blue

## TRAVEL

- 1** 1 mm
- 1.5** 1.5 mm
- 2** 2 mm

## OPERATING FORCE

OPTION CODE	OPERATING FORCE
<b>1.5N OD</b>	1.5 N, 150g without snap-point
<b>2.5N</b>	2.5 N, 250g
<b>3.5N</b>	3.5 N, 350g
<b>5N</b>	5 N, 500g
<b>3.5/7N</b>	3.5/7 N, 350/700g
<b>6/12N</b>	6/12 N, 600-1200g

## CONTACT ARRANGEMENT OPTION

**1R** SPST NC (SPECIAL REQUEST FOR NORMALLY CLOSED OPTION)



Dimensions are shown: mm  
Specifications and dimensions subject to change



Компания «ЭлектроПласт» предлагает заключение долгосрочных отношений при поставках импортных электронных компонентов на взаимовыгодных условиях!

Наши преимущества:

- Оперативные поставки широкого спектра электронных компонентов отечественного и импортного производства напрямую от производителей и с крупнейших мировых складов;
- Поставка более 17-ти миллионов наименований электронных компонентов;
- Поставка сложных, дефицитных, либо снятых с производства позиций;
- Оперативные сроки поставки под заказ (от 5 рабочих дней);
- Экспресс доставка в любую точку России;
- Техническая поддержка проекта, помощь в подборе аналогов, поставка прототипов;
- Система менеджмента качества сертифицирована по Международному стандарту ISO 9001;
- Лицензия ФСБ на осуществление работ с использованием сведений, составляющих государственную тайну;
- Поставка специализированных компонентов (Xilinx, Altera, Analog Devices, Intersil, Interpoint, Microsemi, Aeroflex, Peregrine, Syfer, Eurofarad, Texas Instrument, Miteq, Cobham, E2V, MA-COM, Hittite, Mini-Circuits, General Dynamics и др.);

Помимо этого, одним из направлений компании «ЭлектроПласт» является направление «Источники питания». Мы предлагаем Вам помощь Конструкторского отдела:

- Подбор оптимального решения, техническое обоснование при выборе компонента;
- Подбор аналогов;
- Консультации по применению компонента;
- Поставка образцов и прототипов;
- Техническая поддержка проекта;
- Защита от снятия компонента с производства.



#### Как с нами связаться

**Телефон:** 8 (812) 309 58 32 (многоканальный)

**Факс:** 8 (812) 320-02-42

**Электронная почта:** [org@eplast1.ru](mailto:org@eplast1.ru)

**Адрес:** 198099, г. Санкт-Петербург, ул. Калинина, дом 2, корпус 4, литера А.