

BZX84CxxxET1G Series, SZBZX84CxxxET1G Series

Zener Voltage Regulators

250 mW SOT-23 Surface Mount

This series of Zener diodes is offered in the convenient, surface mount plastic SOT-23 package. These devices are designed to provide voltage regulation with minimum space requirement. They are well suited for applications such as cellular phones, hand held portables, and high density PC boards.

Specification Features

- 250 mW Rating on FR-4 or FR-5 Board
- Zener Breakdown Voltage Range – 2.4 V to 75 V
- Package Designed for Optimal Automated Board Assembly
- Small Package Size for High Density Applications
- ESD Rating of Class 3 (> 16 kV) per Human Body Model
- Peak Power – 225 W (8 X 20 μ s)
- SZ Prefix for Automotive and Other Applications Requiring Unique Site and Control Change Requirements; AEC-Q101 Qualified and PPAP Capable
- These Devices are Pb-Free and are RoHS Compliant*

Mechanical Characteristics

CASE: Void-free, transfer-molded, thermosetting plastic case

FINISH: Corrosion resistant finish, easily solderable

MAXIMUM CASE TEMPERATURE FOR SOLDERING PURPOSES:

260°C for 10 Seconds

POLARITY: Cathode indicated by polarity band

FLAMMABILITY RATING: UL 94 V-0

MAXIMUM RATINGS

Rating	Symbol	Max	Unit
Peak Power Dissipation @ 20 μ s (Note 1) @ $T_L \leq 25^\circ\text{C}$	P_{pk}	225	W
Total Power Dissipation on FR-5 Board, (Note 2) @ $T_A = 25^\circ\text{C}$ Derated above 25°C Thermal Resistance, Junction-to-Ambient	P_D	250	mW
	$R_{\theta JA}$	2.0 500	$\text{mW}/^\circ\text{C}$ $^\circ\text{C}/\text{W}$
Total Power Dissipation on Alumina Substrate, (Note 3) @ $T_A = 25^\circ\text{C}$ Derated above 25°C Thermal Resistance, Junction-to-Ambient	P_D	300	mW
	$R_{\theta JA}$	2.4 417	$\text{mW}/^\circ\text{C}$ $^\circ\text{C}/\text{W}$
Junction and Storage Temperature Range	T_J, T_{stg}	-65 to +150	$^\circ\text{C}$

Stresses exceeding those listed in the Maximum Ratings table may damage the device. If any of these limits are exceeded, device functionality should not be assumed, damage may occur and reliability may be affected.

1. Nonrepetitive current pulse per Figure 9.
2. FR-5 = 1.0 X 0.75 X 0.62 in.
3. Alumina = 0.4 X 0.3 X 0.024 in, 99.5% alumina.

*For additional information on our Pb-Free strategy and soldering details, please download the ON Semiconductor Soldering and Mounting Techniques Reference Manual, SOLDERRM/D.



ON Semiconductor®

www.onsemi.com

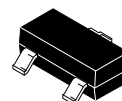

**SOT-23
CASE 318
STYLE 8**



MARKING DIAGRAM

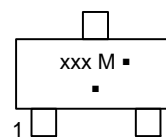

xxx = Device Code
M = Date Code*
▪ = Pb-Free Package

(Note: Microdot may be in either location)

*Date Code orientation may vary depending upon manufacturing location.

ORDERING INFORMATION

Device	Package	Shipping†
BZX84CxxxET1G	SOT-23 (Pb-Free)	3,000 / Tape & Reel
SZBZX84CxxxET1G	SOT-23 (Pb-Free)	3,000 / Tape & Reel
BZX84CxxxET3G	SOT-23 (Pb-Free)	10,000 / Tape & Reel
SZBZX84CxxxET3G	SOT-23 (Pb-Free)	10,000 / Tape & Reel

†For information on tape and reel specifications, including part orientation and tape sizes, please refer to our Tape and Reel Packaging Specification Brochure, BRD8011/D.

DEVICE MARKING INFORMATION

See specific marking information in the device marking column of the Electrical Characteristics table on page 3 of this data sheet.

BZX84CxxxET1G Series, SZBZX84CxxxET1G Series

ELECTRICAL CHARACTERISTICS

(Pinout: 1-Anode, 2-No Connection, 3-Cathode) ($T_A = 25^\circ\text{C}$ unless otherwise noted, $V_F = 0.90\text{ V Max. @ } I_F = 10\text{ mA}$)

Symbol	Parameter
V_Z	Reverse Zener Voltage @ I_{ZT}
I_{ZT}	Reverse Current
Z_{ZT}	Maximum Zener Impedance @ I_{ZT}
I_R	Reverse Leakage Current @ V_R
V_R	Reverse Voltage
I_F	Forward Current
V_F	Forward Voltage @ I_F
ΘV_Z	Maximum Temperature Coefficient of V_Z
C	Max. Capacitance @ $V_R = 0$ and $f = 1\text{ MHz}$

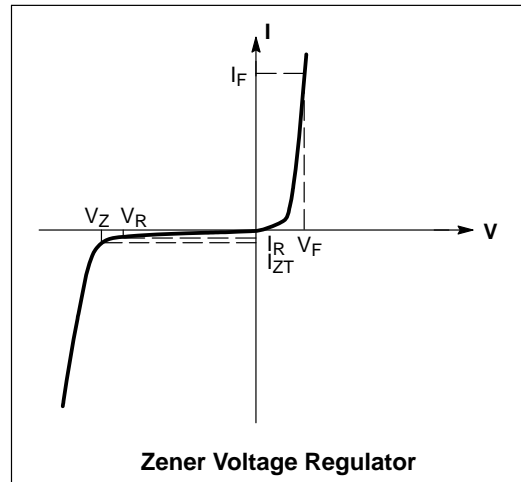

BZX84CxxxET1G Series, SZBZX84CxxxET1G Series

ELECTRICAL CHARACTERISTICS

(Pinout: 1-Anode, 2-No Connection, 3-Cathode) ($T_A = 25^\circ\text{C}$ unless otherwise noted, $V_F = 0.90\text{ V Max.}$ @ $I_F = 10\text{ mA}$)

Device*	Device Marking	V_{Z1} (V) @ $I_{ZT1} = 5\text{ mA}$ (Note 4)			Z_{ZT1} (Ω) @ $I_{ZT1} = 5\text{ mA}$	V_{Z2} (V) @ $I_{ZT2} = 1\text{ mA}$ (Note 4)		Z_{ZT2} (Ω) @ $I_{ZT2} = 1\text{ mA}$	V_{Z3} (V) @ $I_{ZT3} = 20\text{ mA}$ (Note 4)		Z_{ZT3} (Ω) @ $I_{ZT3} = 20\text{ mA}$	Max Reverse Leakage Current		θ_{VZ} (mV/k) @ $I_{ZT1} = 5\text{ mA}$		C (pF) @ $V_R = 0\text{ V}$ $f = 1\text{ MHz}$
		Min	Nom	Max		Min	Max		Min	Max		I_R (μA)	V_R (V)	Min	Max	
BZX84C2V4ET1G	BA1	2.2	2.4	2.6	100	1.7	2.1	600	2.6	3.2	50	50	1.0	-3.5	0	450
BZX84C2V7ET1G	BA2	2.5	2.7	2.9	100	1.9	2.4	600	3.0	3.6	50	20	1.0	-3.5	0	450
BZX84C3V0ET1G	BA3	2.8	3.0	3.2	95	2.1	2.7	600	3.3	3.9	50	10	1.0	-3.5	0	450
BZX84C3V3ET1G	BA4	3.1	3.3	3.5	95	2.3	2.9	600	3.6	4.2	40	5.0	1.0	-3.5	0	450
BZX84C3V6ET1G	BA5	3.4	3.6	3.8	90	2.7	3.3	600	3.9	4.5	40	5.0	1.0	-3.5	0	450
BZX84C3V9ET1G	BA6	3.7	3.9	4.1	90	2.9	3.5	600	4.1	4.7	30	3.0	1.0	-3.5	-2.5	450
BZX84C4V3ET1G	BA7	4.0	4.3	4.6	90	3.3	4.0	600	4.4	5.1	30	3.0	1.0	-3.5	0	450
BZX84C4V7ET1G	BA9	4.4	4.7	5.0	80	3.7	4.7	500	4.5	5.4	15	3.0	2.0	-3.5	0.2	260
BZX84C5V1ET1G	BB1	4.8	5.1	5.4	60	4.2	5.3	480	5.0	5.9	15	2.0	2.0	-2.7	1.2	225
BZX84C5V6ET1G	BB2	5.2	5.6	6.0	40	4.8	6.0	400	5.2	6.3	10	1.0	2.0	-2	2.5	200
BZX84C6V2ET1G	BB3	5.8	6.2	6.6	10	5.6	6.6	150	5.8	6.8	6	3.0	4.0	0.4	3.7	185
BZX84C6V8ET1G	BB4	6.4	6.8	7.2	15	6.3	7.2	80	6.4	7.4	6	2.0	4.0	1.2	4.5	155
BZX84C7V5ET1G	BB5	7.0	7.5	7.9	15	6.9	7.9	80	7.0	8.0	6	1.0	5.0	2.5	5.3	140
BZX84C8V2ET1G	BB6	7.7	8.2	8.7	15	7.6	8.7	80	7.7	8.8	6	0.7	5.0	3.2	6.2	135
BZX84C9V1ET1G	BB7	8.5	9.1	9.6	15	8.4	9.6	100	8.5	9.7	8	0.5	6.0	3.8	7.0	130
BZX84C10ET1G	BB8	9.4	10	10.6	20	9.3	10.6	150	9.4	10.7	10	0.2	7.0	4.5	8.0	130
BZX84C11ET1G	BB9	10.4	11	11.6	20	10.2	11.6	150	10.4	11.8	10	0.1	8.0	5.4	9.0	130
BZX84C12ET1G	BC1	11.4	12	12.7	25	11.2	12.7	150	11.4	12.9	10	0.1	8.0	6.0	10	130
BZX84C13ET1G	BC2	12.4	13	14.1	30	12.3	14	170	12.5	14.2	15	0.1	8.0	7.0	11	120
BZX84C15ET1G	BC3	13.8	15	15.6	30	13.7	15.5	200	13.9	15.7	20	0.05	10.5	9.2	13	110
BZX84C16ET1G	BC4	15.3	16	17.1	40	15.2	17	200	15.4	17.2	20	0.05	11.2	10.4	14	105
BZX84C18ET1G	BC5	16.8	18	19.1	45	16.7	19	225	16.9	19.2	20	0.05	12.6	12.4	16	100
BZX84C20ET1G	BC6	18.8	20	21.2	55	18.7	21.1	225	18.9	21.4	20	0.05	14	14.4	18	85
BZX84C22ET1G	BC7	20.8	22	23.3	55	20.7	23.2	250	20.9	23.4	25	0.05	15.4	16.4	20	85
BZX84C24ET1G	BC8	22.8	24	25.6	70	22.7	25.5	250	22.9	25.7	25	0.05	16.8	18.4	22	80
Device*	Device Marking	V_{Z1} Below @ $I_{ZT1} = 2\text{ mA}$			Z_{ZT1} Below @ $I_{ZT1} = 2\text{ mA}$	V_{Z2} Below @ $I_{ZT2} = 0.1\text{ mA}$		Z_{ZT2} Below @ $I_{ZT4} = 0.5\text{ mA}$	V_{Z3} Below @ $I_{ZT3} = 10\text{ mA}$		Z_{ZT3} Below @ $I_{ZT3} = 10\text{ mA}$	Max Reverse Leakage Current		θ_{VZ} (mV/k) Below @ $I_{ZT1} = 2\text{ mA}$		C (pF) @ $V_R = 0\text{ V}$ $f = 1\text{ MHz}$
		Min	Nom	Max		Min	Max		Min	Max		I_R (μA)	V_R (V)	Min	Max	
BZX84C27ET1G	BC9	25.1	27	28.9	80	25	28.9	300	25.2	29.3	45	0.05	18.9	21.4	25.3	70
BZX84C30ET1G	BD1	28	30	32	80	27.8	32	300	28.1	32.4	50	0.05	21	24.4	29.4	70
BZX84C33ET1G	BD2	31	33	35	80	30.8	35	325	31.1	35.4	55	0.05	23.1	27.4	33.4	70
BZX84C36ET1G	BD3	34	36	38	90	33.8	38	350	34.1	38.4	60	0.05	25.2	30.4	37.4	70
BZX84C39ET1G	BD4	37	39	41	130	36.7	41	350	37.1	41.5	70	0.05	27.3	33.4	41.2	45
BZX84C43ET1G	BK6	40	43	46	150	39.7	46	375	40.1	46.5	80	0.05	30.1	37.6	46.6	40
BZX84C47ET1G	BD5	44	47	50	170	43.7	50	375	44.1	50.5	90	0.05	32.9	42	51.8	40
BZX84C51ET1G	BD6	48	51	54	180	47.6	54	400	48.1	54.6	100	0.05	35.7	46.6	57.2	40
BZX84C56ET1G	BD7	52	56	60	200	51.5	60	425	52.1	60.8	110	0.05	39.2	52.2	63.8	40
BZX84C62ET1G	BD8	58	62	66	215	57.4	66	450	58.2	67	120	0.05	43.4	58.8	71.6	35
BZX84C68ET1G	BD9	64	68	72	240	63.4	72	475	64.2	73.2	130	0.05	47.6	65.6	79.8	35
BZX84C75ET1G	BE1	70	75	79	255	69.4	79	500	70.3	80.2	140	0.05	52.5	73.4	88.6	35

4. Zener voltage is measured with a pulse test current I_Z at an ambient temperature of 25°C

* Include SZ-prefix devices where applicable.

BZX84CxxxET1G Series, SZBZX84CxxxET1G Series

TYPICAL CHARACTERISTICS



**Figure 1. Temperature Coefficients
(Temperature Range -55°C to +150°C)**



**Figure 2. Temperature Coefficients
(Temperature Range -55°C to +150°C)**

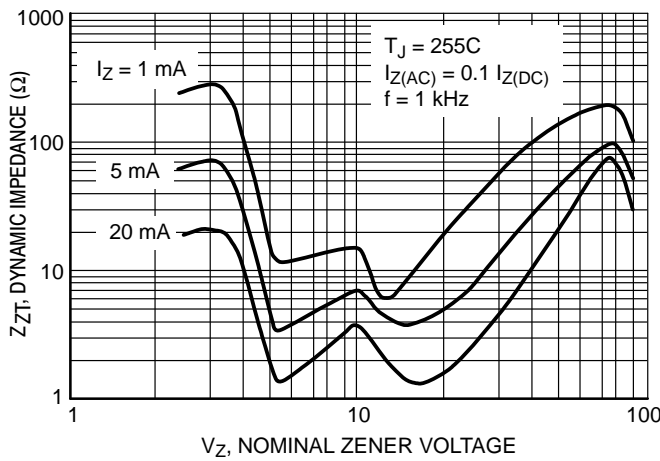

**Figure 3. Effect of Zener Voltage on
Zener Impedance**

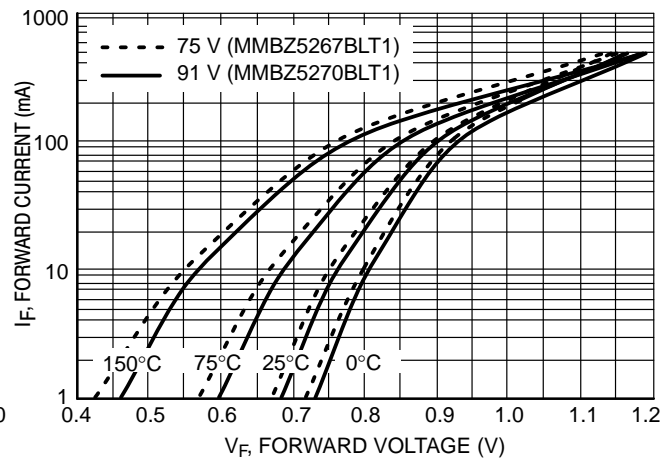

Figure 4. Typical Forward Voltage

BZX84CxxxET1G Series, SZBZX84CxxxET1G Series

TYPICAL CHARACTERISTICS



Figure 5. Typical Capacitance

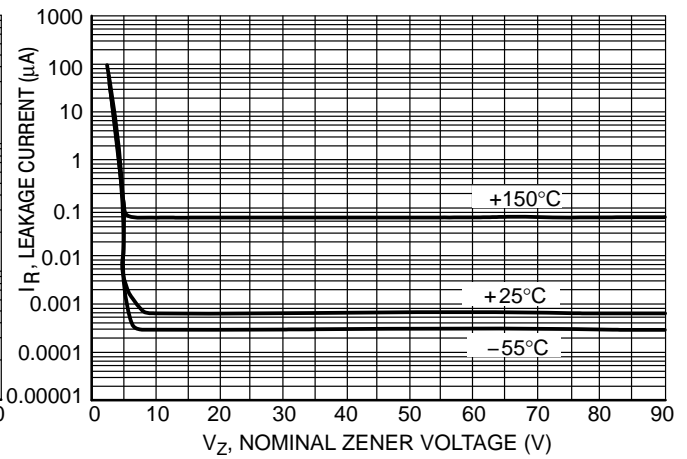

Figure 6. Typical Leakage Current



Figure 7. Zener Voltage versus Zener Current
(V_Z Up to 12 V)

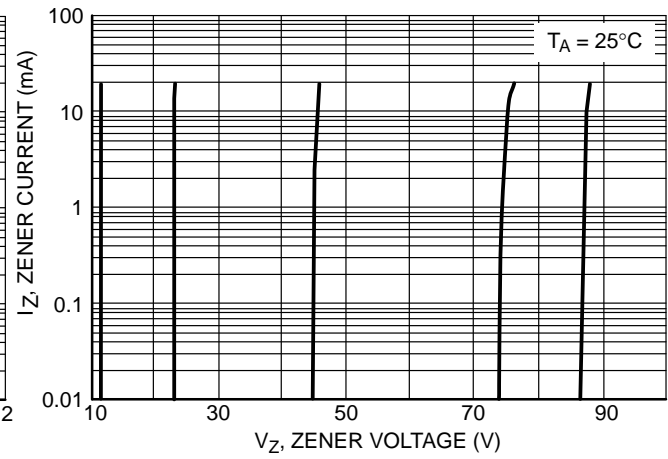

Figure 8. Zener Voltage versus Zener Current
(12 V to 91 V)

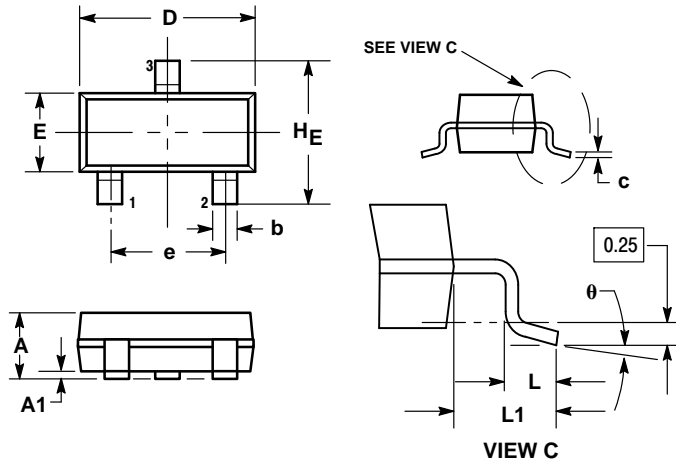

Figure 9. $8 \times 20 \mu\text{s}$ Pulse Waveform

BZX84CxxxET1G Series, SZBZX84CxxxET1G Series

PACKAGE DIMENSIONS

SOT-23 (TO-236)
CASE 318-08
ISSUE AP



NOTES:

1. DIMENSIONING AND TOLERANCING PER ANSI Y14.5M, 1982.
2. CONTROLLING DIMENSION: INCH.
3. MAXIMUM LEAD THICKNESS INCLUDES LEAD FINISH THICKNESS. MINIMUM LEAD THICKNESS IS THE MINIMUM THICKNESS OF BASE MATERIAL.
4. DIMENSIONS D AND E DO NOT INCLUDE MOLD FLASH, PROTRUSIONS, OR GATE BURRS.

DIM	MILLIMETERS			INCHES		
	MIN	NOM	MAX	MIN	NOM	MAX
A	0.89	1.00	1.11	0.035	0.040	0.044
A1	0.01	0.06	0.10	0.001	0.002	0.004
b	0.37	0.44	0.50	0.015	0.018	0.020
c	0.09	0.13	0.18	0.003	0.005	0.007
D	2.80	2.90	3.04	0.110	0.114	0.120
E	1.20	1.30	1.40	0.047	0.051	0.055
e	1.78	1.90	2.04	0.070	0.075	0.081
L	0.10	0.20	0.30	0.004	0.008	0.012
L1	0.35	0.54	0.69	0.014	0.021	0.029
HE	2.10	2.40	2.64	0.083	0.094	0.104
θ	0°	---	10°	0°	---	10°

STYLE 8:

1. ANODE
2. NO CONNECTION
3. CATHODE

SOLDERING FOOTPRINT*

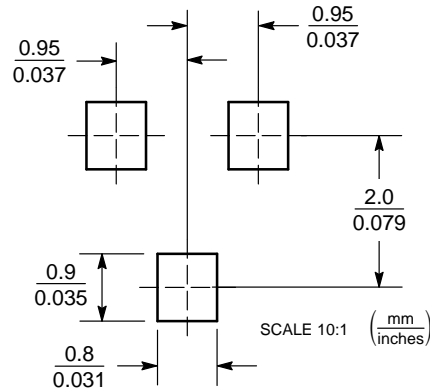

*For additional information on our Pb-Free strategy and soldering details, please download the ON Semiconductor Soldering and Mounting Techniques Reference Manual, SOLDERRM/D.

ON Semiconductor and are registered trademarks of Semiconductor Components Industries, LLC (SCILLC). SCILLC reserves the right to make changes without further notice to any products herein. SCILLC makes no warranty, representation or guarantee regarding the suitability of its products for any particular purpose, nor does SCILLC assume any liability arising out of the application or use of any product or circuit, and specifically disclaims any and all liability, including without limitation special, consequential or incidental damages. "Typical" parameters which may be provided in SCILLC data sheets and/or specifications can and do vary in different applications and actual performance may vary over time. All operating parameters, including "Typicals" must be validated for each customer application by customer's technical experts. SCILLC does not convey any license under its patent rights nor the rights of others. SCILLC products are not designed, intended, or authorized for use as components in systems intended for surgical implant into the body, or other applications intended to support or sustain life, or for any other application in which the failure of the SCILLC product could create a situation where personal injury or death may occur. Should Buyer purchase or use SCILLC products for any such unintended or unauthorized application, Buyer shall indemnify and hold SCILLC and its officers, employees, subsidiaries, affiliates, and distributors harmless against all claims, costs, damages, and expenses, and reasonable attorney fees arising out of, directly or indirectly, any claim of personal injury or death associated with such unintended or unauthorized use, even if such claim alleges that SCILLC was negligent regarding the design or manufacture of the part. SCILLC is an Equal Opportunity/Affirmative Action Employer. This literature is subject to all applicable copyright laws and is not for resale in any manner.

PUBLICATION ORDERING INFORMATION

LITERATURE FULFILLMENT:
Literature Distribution Center for ON Semiconductor
P.O. Box 5163, Denver, Colorado 80217 USA
Phone: 303-675-2175 or 800-344-3860 Toll Free USA/Canada
Fax: 303-675-2176 or 800-344-3867 Toll Free USA/Canada
Email: orderlit@onsemi.com

N. American Technical Support: 800-282-9855 Toll Free USA/Canada
Europe, Middle East and Africa Technical Support:
Phone: 421 33 790 2910
Japan Customer Focus Center
Phone: 81-3-5817-1050

ON Semiconductor Website: www.onsemi.com
Order Literature: <http://www.onsemi.com/orderlit>

For additional information, please contact your local Sales Representative



Компания «ЭлектроПласт» предлагает заключение долгосрочных отношений при поставках импортных электронных компонентов на взаимовыгодных условиях!

Наши преимущества:

- Оперативные поставки широкого спектра электронных компонентов отечественного и импортного производства напрямую от производителей и с крупнейших мировых складов;
- Поставка более 17-ти миллионов наименований электронных компонентов;
- Поставка сложных, дефицитных, либо снятых с производства позиций;
- Оперативные сроки поставки под заказ (от 5 рабочих дней);
- Экспресс доставка в любую точку России;
- Техническая поддержка проекта, помощь в подборе аналогов, поставка прототипов;
- Система менеджмента качества сертифицирована по Международному стандарту ISO 9001;
- Лицензия ФСБ на осуществление работ с использованием сведений, составляющих государственную тайну;
- Поставка специализированных компонентов (Xilinx, Altera, Analog Devices, Intersil, Interpoint, Microsemi, Aeroflex, Peregrine, Syfer, Eurofarad, Texas Instrument, Miteq, Cobham, E2V, MA-COM, Hittite, Mini-Circuits, General Dynamics и др.);

Помимо этого, одним из направлений компании «ЭлектроПласт» является направление «Источники питания». Мы предлагаем Вам помощь Конструкторского отдела:

- Подбор оптимального решения, техническое обоснование при выборе компонента;
- Подбор аналогов;
- Консультации по применению компонента;
- Поставка образцов и прототипов;
- Техническая поддержка проекта;
- Защита от снятия компонента с производства.



Как с нами связаться

Телефон: 8 (812) 309 58 32 (многоканальный)

Факс: 8 (812) 320-02-42

Электронная почта: org@eplast1.ru

Адрес: 198099, г. Санкт-Петербург, ул. Калинина, дом 2, корпус 4, литера А.