

Using the UCC28250EVM-501

User's Guide



Literature Number: SLUU429B
June 2010–Revised December 2010

Half-Bridge DC-to-DC Converter With Primary-Side Control

1 Introduction

This EVM is to help evaluating UCC28250 PWM device with primary-side control in DC-to-DC symmetrical half-bridge converter topology. The targeted application is telecom module design with nominal 48-V input. UCC28250 is a PWM controller that can be used for primary-side control or secondary-side control. In this EVM, the UCC28250 is placed at primary side to make primary-side control.

2 Description

The EVM is a 75-W symmetrical half-bridge DC-to-DC converter that converts 36-V to 72-V DC to a regulated output voltage 3.3 V and maximum 23-A load current.

2.1 Typical Applications

- Telecom power supplies with primary-side control
- Server systems
- Datacom
- DSP's, ASIC's, and FPGA's

2.2 Features

- Start up directly from telecom input voltage 36-V to 72-V DC.
- Regulated output voltage 3.3 V with maximum 23-A load current.
- Telecom basic isolation from primary to secondary 1500 V.
- Output voltage regulation from no load to full load, and from low line to high line.
- Control driven synchronous rectifier.
- All surface mount components, double sided close to form factor of quarter brick.
- Voltage mode control.
- Remote Enable ON/OFF Function and manual switch.
- Non-latching input over voltage protection.
- Non-latching input under voltage protection.
- Hiccup over current protection.
- Test points to facilitate the devices evaluation.

3 Electrical Performance Specifications

Table 1. UCC28250EVM-501 Electrical Performance Specifications

PARAMETER	TEST CONDITIONS	MIN	TYP	MAX	UNITS
Input Characteristics					
Voltage range		36	48	72	V
Maximum input current	$V_{IN} = 36\text{ V}$ and $I_{OUT} = 23\text{ A}$			2.35	A
No load input current				50	mA
Output Characteristics					
Output voltage, V_{OUT}	Output current = 0 A	3.25	3.3	3.35	V
Output load current, I_{OUT}				23	A
Output voltage regulation	Line regulation: input voltage = 36 V to 72 V			0.1%	
	Load regulation: output current = 0 A to 23 A			0.1%	
Output voltage ripple	At $I_{OUT} = 23\text{ A}$		50		mV _{PP}
Output over current		26			A
Systems Characteristics					
Switching frequency			150		kHz
Operation frequency			300		
Peak efficiency			91%		
Full load efficiency			90%		
Operating temperature	Min 200 LFM force air flow		45		°C

4 Schematic

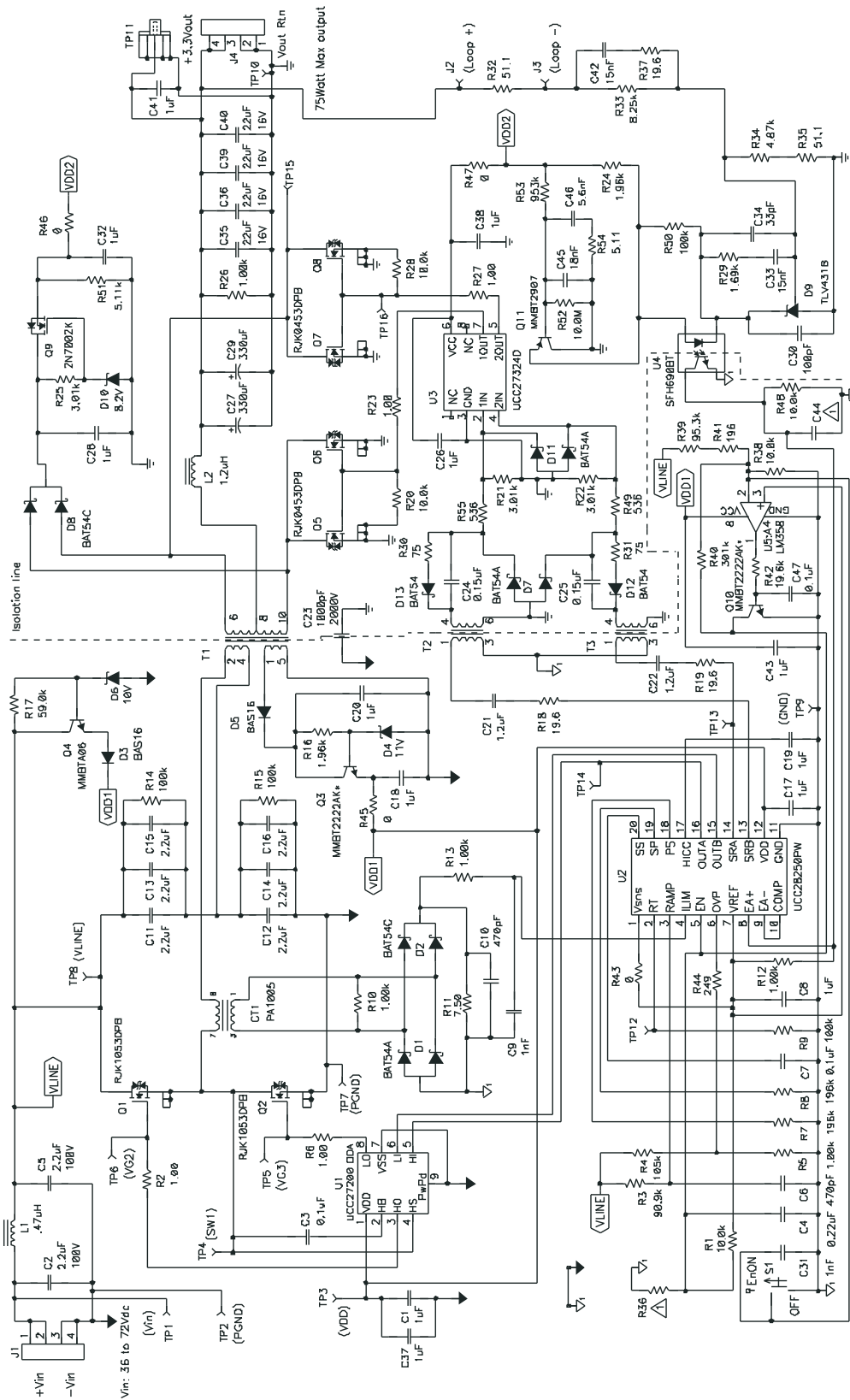

Figure 1. UCC28250EVM-501 Schematic

5 Test Setup

5.1 Test Equipment

Voltage Source: HP 6015A DC Power Supply

Multimeters: Fluke 45 Dual Display Multimeter

Output Load: HP 6060A DC Electronic Load

Oscilloscope: Tektronix TDS 460 A, 400 MHz

Fan: 200 LFM minimum compatible

Recommended Wire Gauge: AWG #18 for input voltage connection. AWG #16 for output load connection.

5.2 Recommended Test Setup

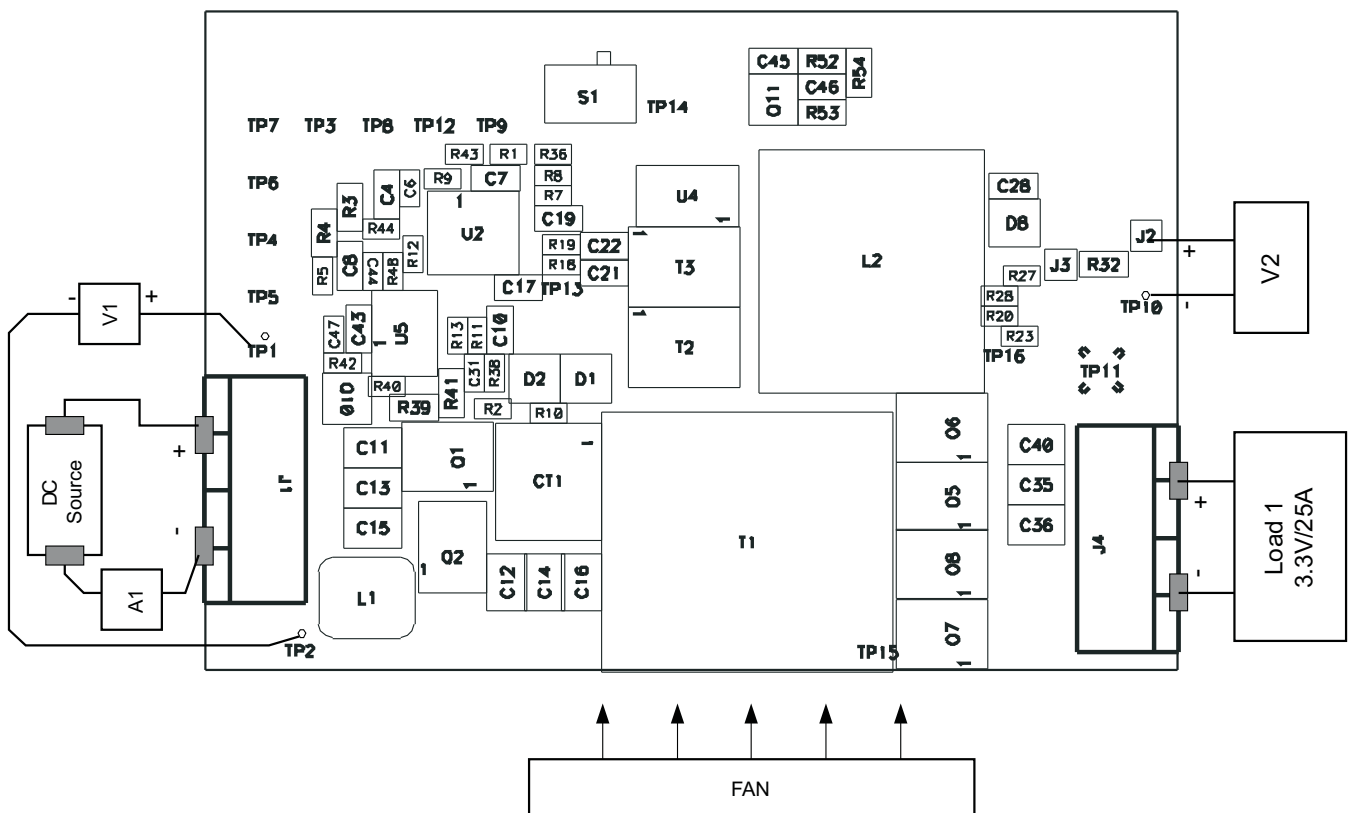

Figure 2. Recommended Test Set Up

5.3 List of Test Points

Table 2. Test Point Functions

TEST POINTS	NAME	DESCRIPTION
TP1	VIN	Input voltage positive test point, for efficiency test
TP2	PGND	Input voltage negative test point, for efficiency test
TP3	VDD	Primary-side bias voltage
TP4	SW1	Primary-side switch node (intersection of Q1 and Q2)
TP5	VG3	Primary-side Q2 gate
TP6	VG2	Primary-side Q1 gate
TP7	PGND	Primary-side power ground
TP8	VLINE	Primary-side positive input voltage terminal after input filter
TP9	GND	Primary-side signal ground
TP10	GND_S	Secondary-side ground
TP11	Vo_rpl	Output voltage ripple test point
TP12	F_SYNC	Primary-side IC RT-pin (external frequency synchronization)
TP13	SRA	Primary-side IC SRA-pin
TP14	OUTA	Primary-side IC OUTA-pin
TP15	VD_S	Secondary-side MOSFET drain pin (Q7 and Q8)
TP16	VG_S	Secondary-side MOSFET gate pin (Q7 and Q8)
J1	INPUT	Input voltage terminals
J2	Loop+	Feedback loop test point
J3	Loop-	Feedback loop test point
J4	OUTPUT	Output voltage terminals

6 Test Procedure

Set up the EVM based on [Figure 2](#).

CAUTION

!! Caution: High voltage and high temperature present when the EVM is in operation !!

6.1 Line/Load Regulation and Efficiency Measurement Procedure

1. Connect the ammeter A1 (0 A to 10 A range) between DC source and J1 as shown in [Figure 2](#).
2. Prior to connecting the DC source, it is advisable to limit the source current to 3 A maximum. Make sure the DC source is initially set to 0 V and connected to J1 and A1 as shown in [Figure 2](#).
3. Connect voltmeter, V1 across the DC source as shown in [Figure 2](#).
4. Connect Load1 to J5 as shown in [Figure 2](#). Set Load1 to constant current mode to sink 0 A_{DC} before the input voltage on J1 is applied.
5. Connect voltmeter, V2 to J2 and TP10 as shown in [Figure 2](#).
6. Turn on fan making sure to blow air directly on the EVM.
7. Set S1 to ON position, then increase the DC source voltage from 0 V to 36.0 V_{DC}.
8. Measure VOUT (V2), IOU_T, VIN (V1) and I_{IN} (A1).
9. Vary LOAD1 from 0 A to a higher value, up to 23 A_{DC}.
10. Repeat step 8.
11. Increase input voltage to a different value, up to 72 V, and repeat step 8 and 9.

6.2 Equipment Shutdown

1. Decrease Load1 to 0 A.
2. Decrease VIN from 72.0 V_{DC} to 0 V.
3. Shut down VIN and Fan.
4. Shut down the load.

7 Performance Data and Typical Characteristic Curves

Figure 3 through Figure 11 present typical performance curves for UCC28250EVM-501.

7.1 Efficiency

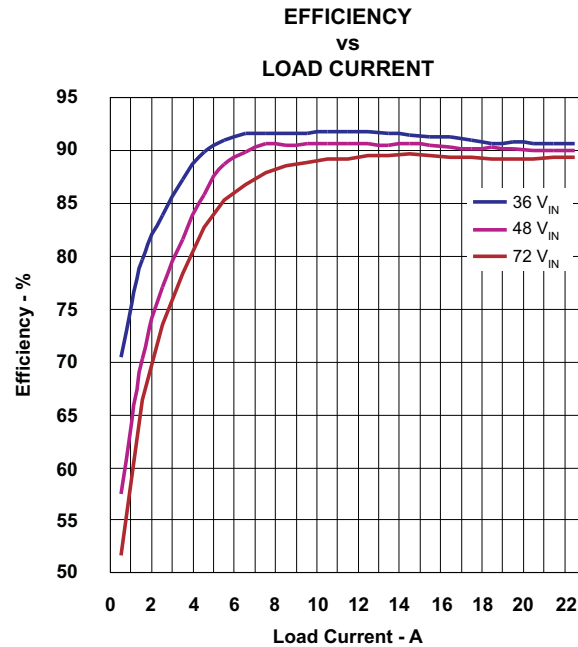

Figure 3. Efficiency

7.2 Load Regulation

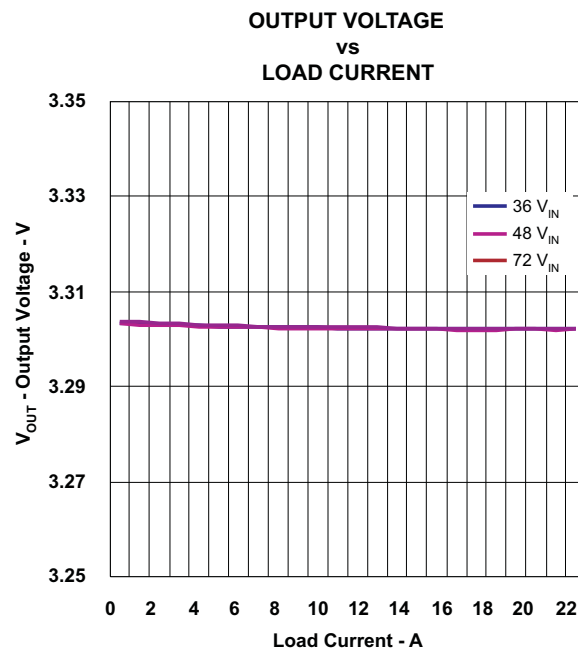

Figure 4. Load Regulation

7.3 Bode Plot

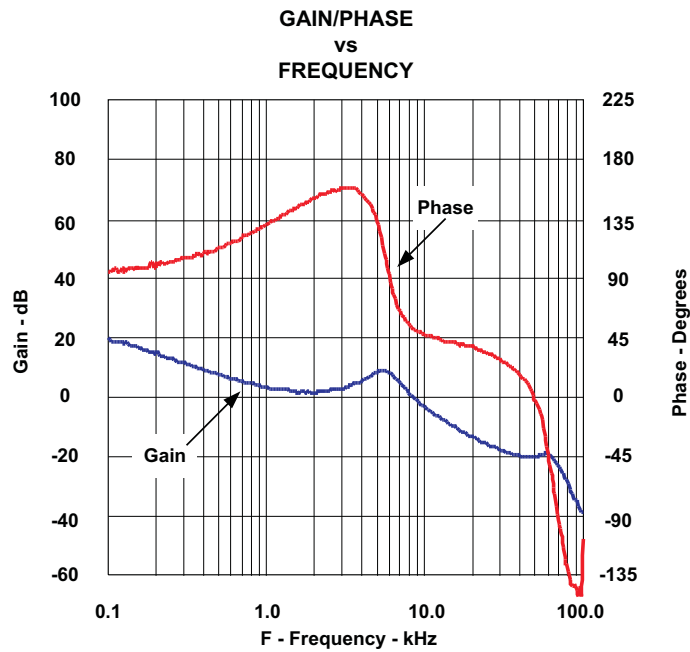

Figure 5. Loop Response Gain and Phase

7.4 Transient Response

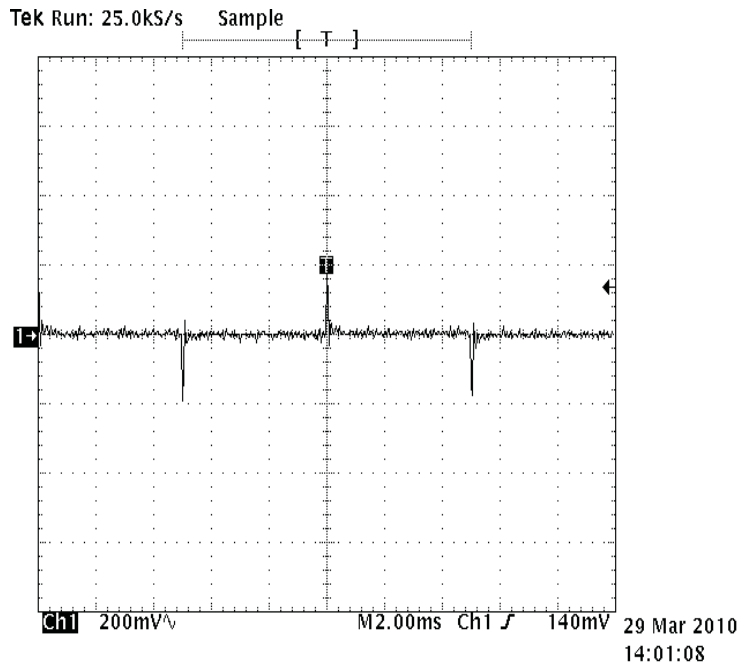

Figure 6. Load Transient

7.5 Output Ripple

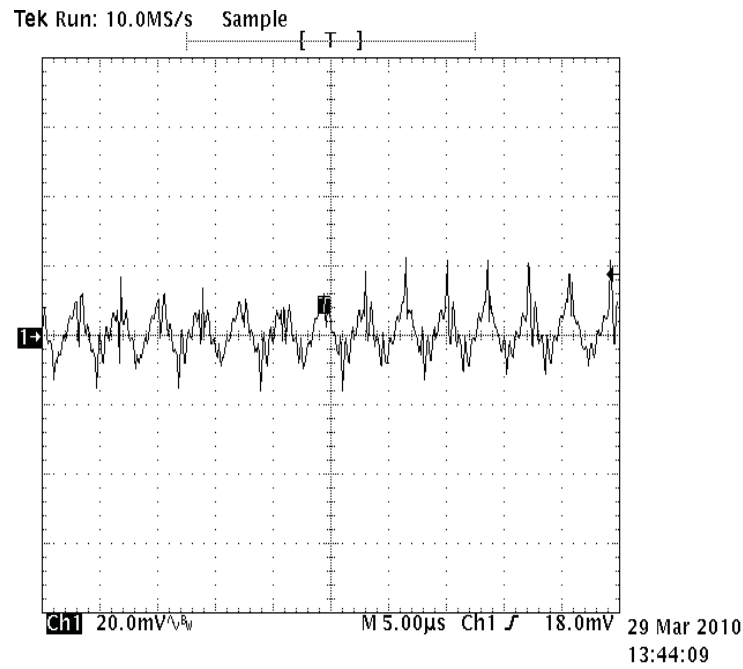

Figure 7. Output Ripple

7.6 Gate Drive Signal and Switch Node Voltage

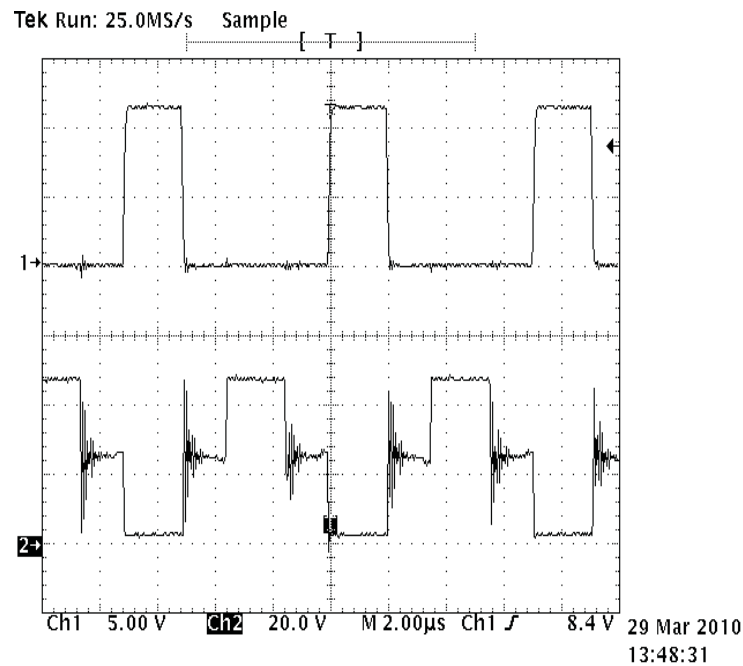

Figure 8. Clock Signal and Switching Node Waveform

7.7 Turn-On Waveform

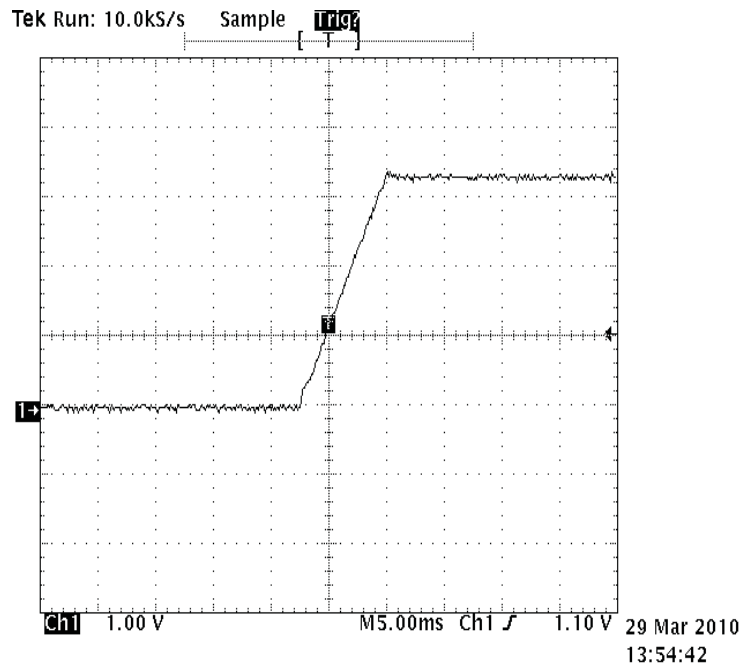

Figure 9. Enable Turn-On Waveform

7.8 Turn-Off Waveform

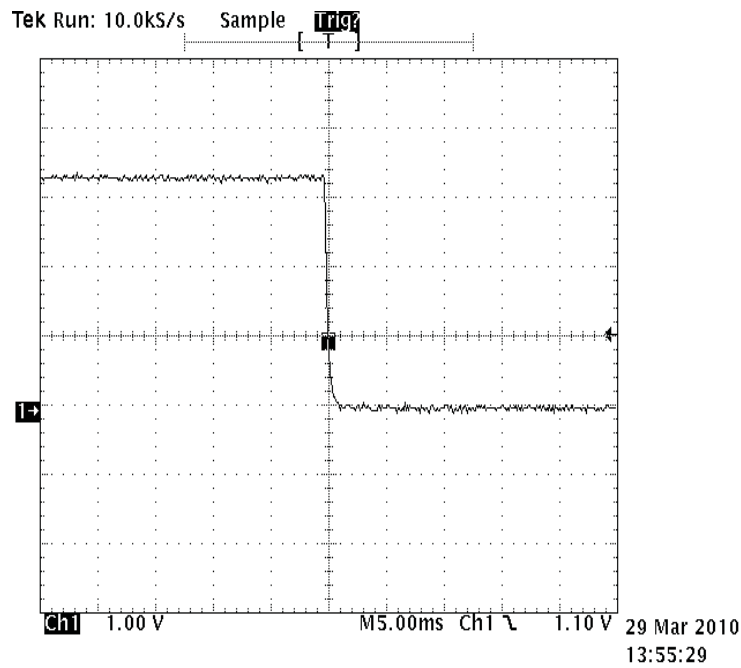

Figure 10. Enable Turn-Off Waveform

7.9 Secondary-Side Switching Waveform

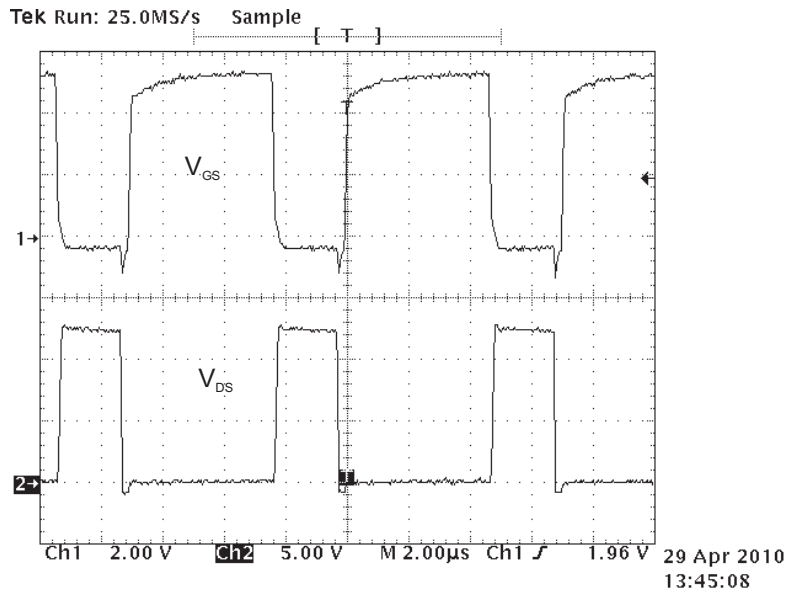

Figure 11. Secondary-Side Switching Waveform

8 EVM Assembly Drawing and PCB layout

Figure 12 through Figure 17 shows the design of the UCC28250EVM-501 printed circuit board. PCB dimensions: L x W = 3.4 in x 2.3 in, PCB material: FR406 or compatible, four layers and 2-oz copper on each layer.

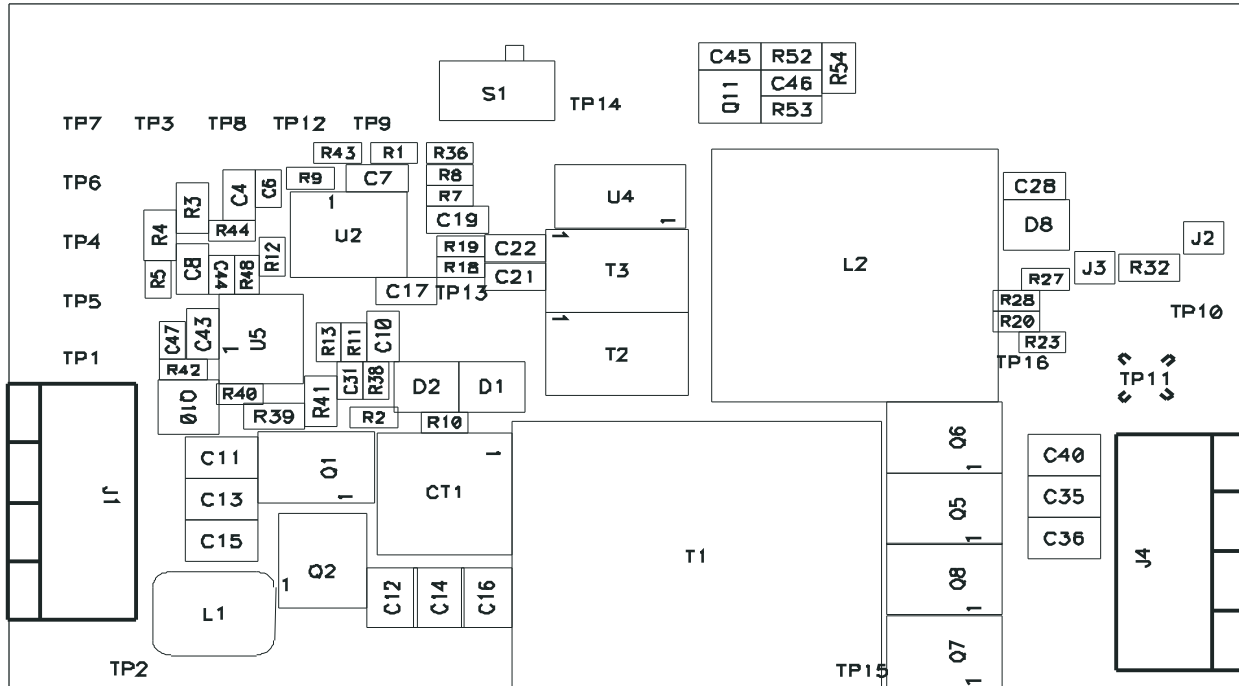

Figure 12. Top Layer Assembly Drawing (top view)

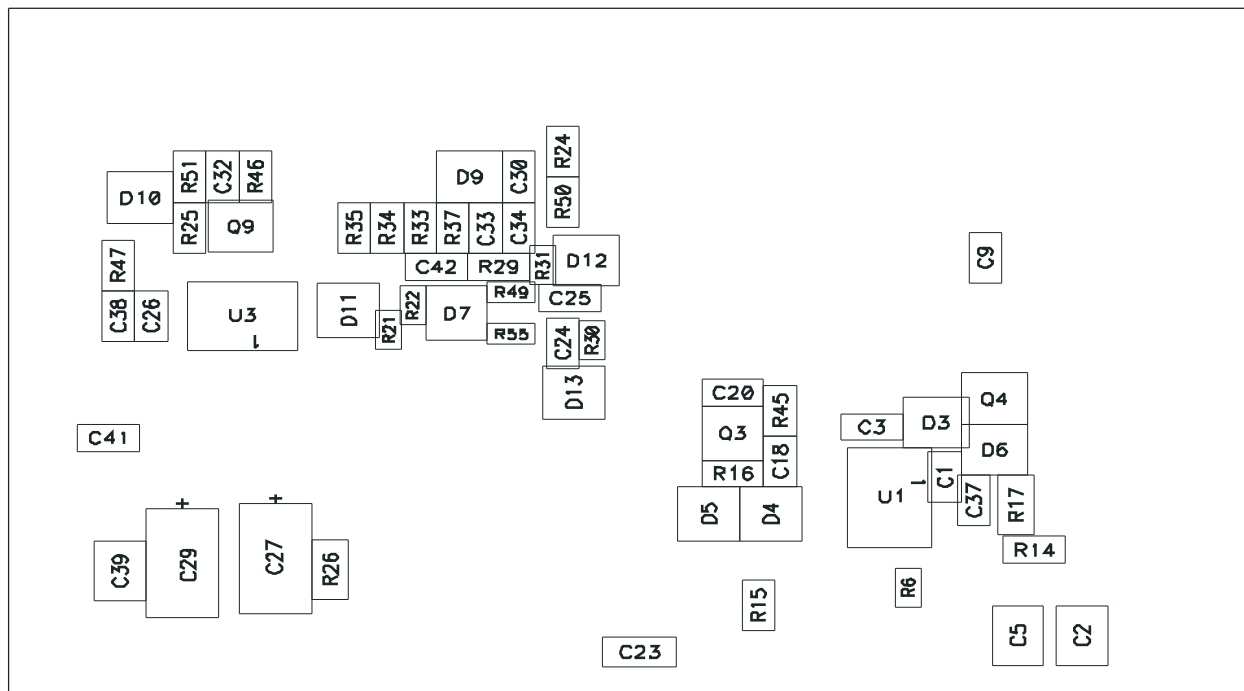

Figure 13. Bottom Assembly Drawing (bottom view)

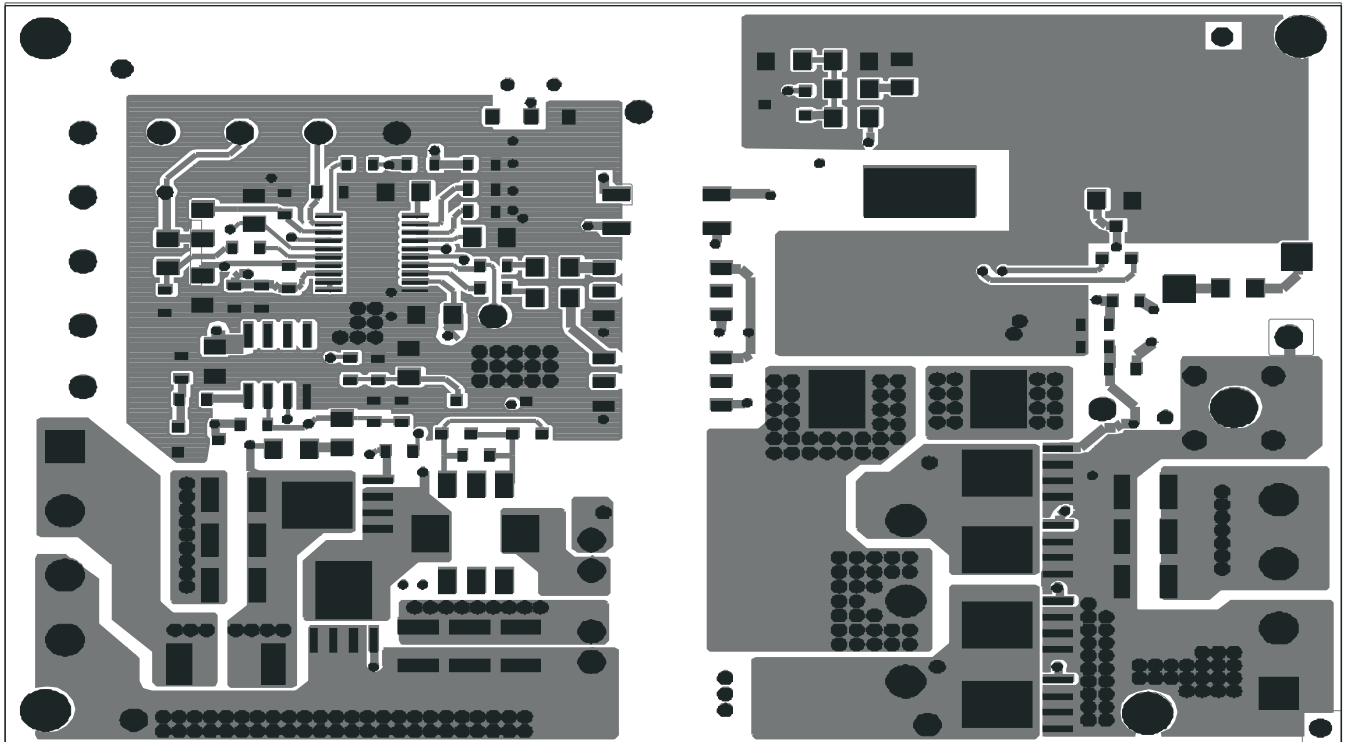

Figure 14. Top Copper (top view)

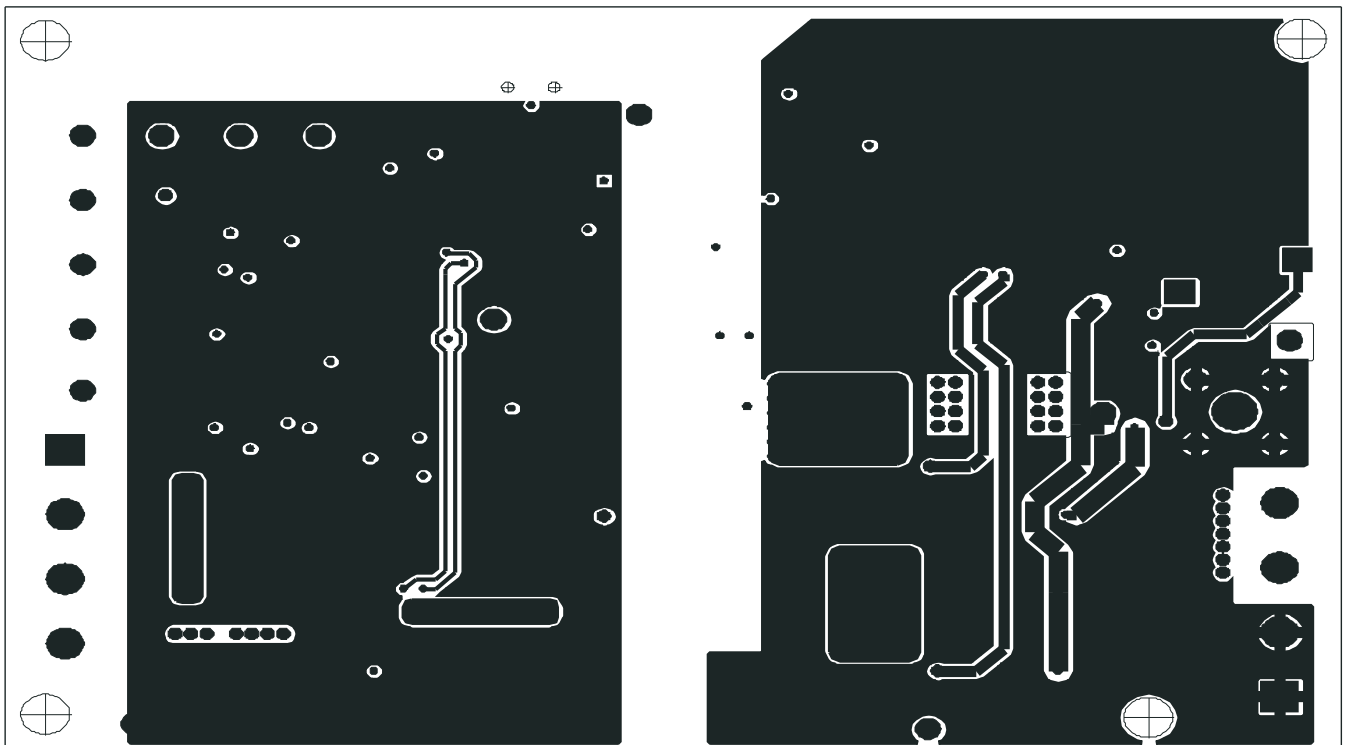

Figure 15. Internal Layer 1 (top view)

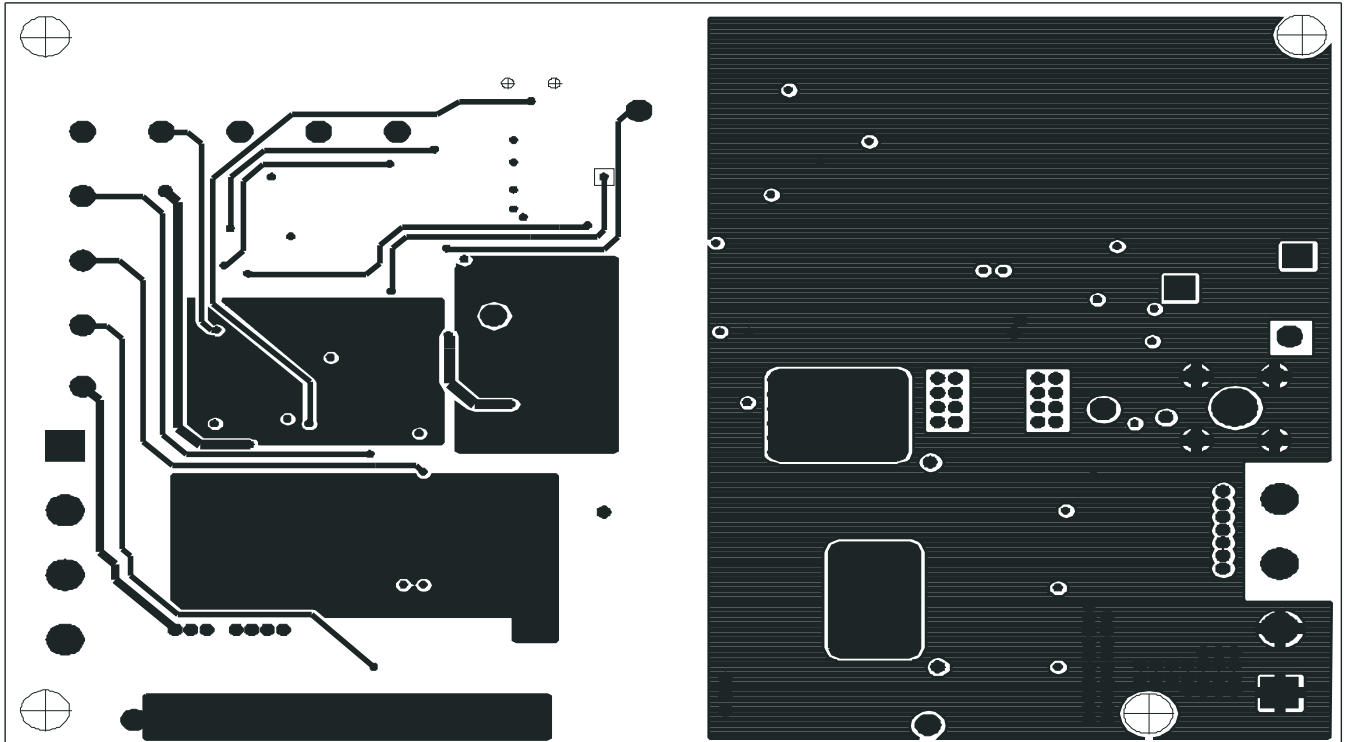

Figure 16. Internal Layer 2 (top view)

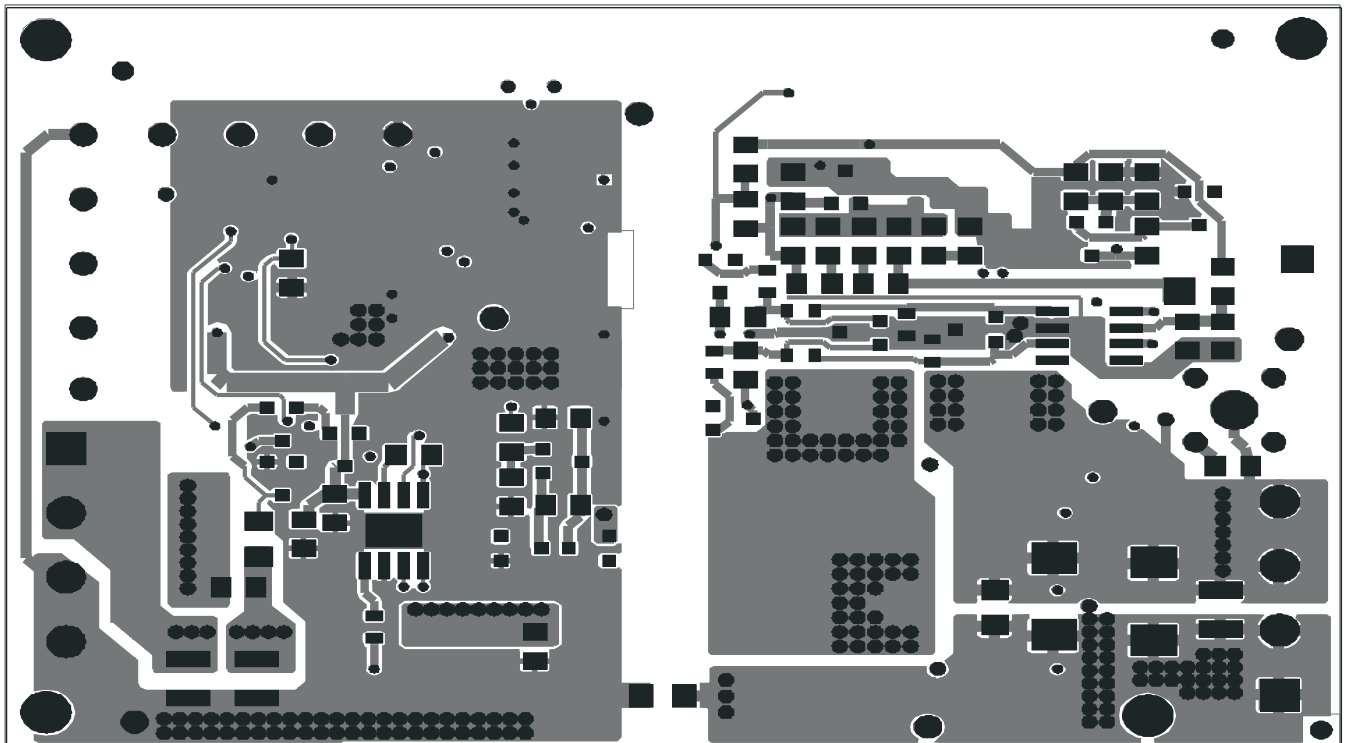

Figure 17. Bottom Copper (top view)

9 List of Materials

The EVM components list according to the schematic shown in [Figure 1](#).

Table 3. UCC28250EVM-501 List of Materials

REF DES	QTY	DESCRIPTION	MFR	PART NUMBER
C1, C8, C17, C18, C19, C20, C26, C28, C32, C37, C38, C41, C43	13	Capacitor, ceramic, 16 V, X5R, $\pm 10\%$, 1 μF	std	std
C10	1	Capacitor, ceramic, 50 V, X7R, $\pm 10\%$, 470 pF	std	std
C2, C5, C11, C12, C13, C14, C15, C16	8	Capacitor, ceramic, 2.2 μF , 100 V, X7R, $\pm 10\%$, 1210	Murata	GRM32ER72A225K A35
C21, C22	2	Capacitor, ceramic, 16 V, X5R, $\pm 10\%$, 1.2 μF	std	std
C23	1	Capacitor, ceramic, 1000 pF, 2000 V, $\pm 10\%$	Johanson Die	202R18W102MV4E
C24, C25	2	Capacitor, ceramic, 16 V, X5R, $\pm 10\%$, 0.15 μF	std	std
C27, C29	2	Capacitor, POSCAP, 9.0 m Ω s, 6.3 V, 20%, 330 μF	Sanyo	6TPF330M9L
C3, C7	2	Capacitor, ceramic, 16 V, X7R, $\pm 10\%$, 0.1 μF	std	std
C30	1	Capacitor, ceramic, 50 V, NPO, $\pm 10\%$, 100 pF	std	std
C31	1	Capacitor, ceramic, 50 V, X7R, $\pm 10\%$, 1 nF	std	std
C33, C42	2	Capacitor, ceramic, 50 V, X7R, 10%, 15 nF	std	std
C34	1	Capacitor, ceramic, 50 V, NPO, 10%, 33 pF	std	std
C35, C36, C39, C40	4	Capacitor, ceramic, 22 μF , 16V, X5R, 10%, 1210	Murata	GRM32ER61C226K E20
C4	1	Capacitor, ceramic, 16 V, X5R, $\pm 10\%$, 0.22 μF	std	std
C44	0	Capacitor, ceramic, 16 V, X7R, $\pm 10\%$, open	std	std
C45	1	Capacitor, ceramic, 16 V, X7R, $\pm 10\%$, 18 nF	std	std
C46	1	Capacitor, ceramic, 50 V, X7R, $\pm 10\%$, 5.6 nF	std	std
C47	1	Capacitor, ceramic, 50 V, X7R, $\pm 10\%$, 0.1 μF	std	std
C6	1	Capacitor, ceramic, 50 V, X7R, $\pm 10\%$, 470 pF	std	std
C9	1	Capacitor, ceramic, 50 V, X7R, $\pm 10\%$, 1 nF	std	std
CT1	1	Transformer, current Sense, 20-A, 1:100	Pulse	PA1005.100
D1, D7, D11	3	Diode, Dual Schottky, 300 mA, 30 V	ST	BAT54AFILM
D10	1	Diode, Zener, 8.2 V, 20 mA, 225 mW, 5%	Onsemi	BZX84C7V5LT1G
D12, D13	2	Diode, Schottky, 200 mA, 30 V	Diodes Inc	BAT54-7-F
D2, D8	2	Diode, Dual Schottky, 200 mA, 30 V	Vishay-Liteon	BAT54C
D3, D5	2	Diode, Switching, 75 V, 200 mA, SOT23	Onsemi	BAS16LT1G
D4	1	Diode, Zener, 11 V, 20 mA, 225 mW, 5%	Onsemi	BZX84C11LT1G
D6	1	Diode, Zener, 10 V, 20 mA, 225 mW, 5%	Onsemi	BZX84C10LT1G
D9	1	Adjustable precision shunt regulator, 0.5%	TI	TLV431BQDBZT
J1, J4	2	Terminal block, 4 pin, 15 A, 5.1 mm	OST	ED2227
J2, J3	2	Pin, thru hole, tin plate, for 0.062 PCB's	Vector	K24A/M
L1	1	Inductor, SMT, 26 A, 4.2 m Ω , 0.47 μH	Vishay	IHLP2525CZERR47 M01
L2	1	Inductor, power, $\pm 20\%$, 1.2 μH	Coilcraft	SER2009-122ML
Q1, Q2	2	MOSFET, N-channel, 100 V, 25 A, 10 m Ω	Renesas	RJK1053DPB
Q11	1	Transistor, PNP, -60 V, -600 mA, 225 W	On Semi	MMBT2907ALT1
Q3, Q10	2	Bipolar, NPN, 40 V_{CEO} , 600 mA, 350 mW	Fairchild	MMBT2222AK
Q4	1	Bipolar, NPN, 80 V_{CEO} , 500 mA, 350 mW	Fairchild	MMBTA06
Q5, Q6, Q7, Q8	4	MOSFET, N-channel, 40 V, 55 A, 1.9 m Ω	Renesas	RJK0453DPB
Q9	1	MOSFET, N channel, 60 V, 115 mA, 1.2 Ω	Fairchild	2N7002K
R1, R20, R28, R38, R48	5	Resistor, chip, 1/16 W, 1%, 10.0 k Ω	std	std

Table 3. UCC28250EVM-501 List of Materials (continued)

REF DES	QTY	DESCRIPTION	MFR	PART NUMBER
R11	1	Resistor, chip, 1/16 W, 1%, 7.5 Ω	std	std
R14, R15, R50	3	Resistor, chip, 1/8 W, 1%, 100 k Ω	std	std
R16, R24	2	Resistor, chip, 1/8 W, 1%, 1.96 k Ω	std	std
R17	1	Resistor, chip, 1/4 W, 1%, 59.0 k Ω	std	std
R18, R19	2	Resistor, chip, 1/16 W, 1%, 19.6 Ω	std	std
R2, R6, R23, R27	4	Resistor, chip, 1/16 W, 1%, 1 Ω	std	std
R21, R22	2	Resistor, chip, 1/16 W, 1%, 3.01 k Ω	std	std
R25	1	Resistor, chip, 1/8 W, 1%, 3.01 k Ω	std	std
R26	1	Resistor, chip, 1/4 W, 1%, 1.00 k Ω	std	std
R29	1	Resistor, chip, 1/8 W, 1%, 1.69 k Ω	std	std
R3	1	Resistor, chip, 1/8 W, 1%, 90.9 k Ω	std	std
R30, R31	2	Resistor, chip, 1/16 W, 1%, 75 Ω	std	std
R32, R35	2	Resistor, chip, 1/8 W, 1%, 51.1 Ω	std	std
R33	1	Resistor, chip, 1/8 W, 1%, 8.25 k Ω	std	std
R34	1	Resistor, chip, 1/8 W, 1%, 4.87 k Ω	std	std
R36	0	Resistor, chip, 1/16 W, 1%, open	std	std
R37	1	Resistor, chip, 1/8 W, 1%, 19.6 Ω	std	std
R39	1	Resistor, chip, 1/8 W, 1%, 95.3 k Ω	std	std
R4	1	Resistor, chip, 1/8 W, 1%, 105 k Ω	std	std
R40	1	Resistor, chip, 1/8 W, 1%, 301 k Ω	std	std
R41	1	Resistor, chip, 1/8 W, 1%, 196 Ω	std	std
R42	1	Resistor, chip, 1/8 W, 1%, 19.6 k Ω	std	std
R43	1	Resistor, chip, 1/8 W, 1%, 0 Ω	std	std
R44	1	Resistor, chip, 1/8 W, 1%, 249 Ω	std	std
R45, R46, R47	3	Resistor, chip, 1/8 W, 1%, 0 Ω	std	std
R49, R55	2	Resistor, chip, 1/16 W, 1%, 536 Ω	std	std
R5, R10, R12, R13	4	Resistor, chip, 1/16 W, 1%, 1.00 k Ω	std	std
R51	1	Resistor, chip, 1/8 W, 1%, 5.11 k Ω	std	std
R52	1	Resistor, chip, 1/8 W, 1%, 10.0 M	std	std
R53	1	Resistor, chip, 1/8 W, 1%, 953 k Ω	std	std
R54	1	Resistor, chip, 1/8 W, 1%, 5.11 Ω	std	std
R7, R8	2	Resistor, chip, 1/16 W, 1%, 196 k Ω	std	std
R9	1	Resistor, chip, 1/16 W, 1%, 100 k Ω	std	std
S1	1	Switch, Actuator SPDT	C & K	AYZ0102AGRLC
T1	1	XFMR, 3.3 V, 30 A, 120 μ H	Coilcraft	DA2025-AL
T2, T3	2	XFMR, Gate Driver \pm 20%, 296 μ H	Coilcraft	DA2319-AL
U1	1	120-V Boot, 2.5-A Peak, High Low-Side Driver	TI	UCC27200 DDA
U2	1	Half Bridge PWM Controller	TI	UCC28250PW
U3	1	MOSFET Driver	TI	UCC27324D
U4	1	Phototransistor, CTR 100% to 300%	Vishay	SFH690BT
U5	1	Dual Operational Amplifiers	TI	LM358D

Evaluation Board/Kit Important Notice

Texas Instruments (TI) provides the enclosed product(s) under the following conditions:

This evaluation board/kit is intended for use for **ENGINEERING DEVELOPMENT, DEMONSTRATION, OR EVALUATION PURPOSES ONLY** and is not considered by TI to be a finished end-product fit for general consumer use. Persons handling the product(s) must have electronics training and observe good engineering practice standards. As such, the goods being provided are not intended to be complete in terms of required design-, marketing-, and/or manufacturing-related protective considerations, including product safety and environmental measures typically found in end products that incorporate such semiconductor components or circuit boards. This evaluation board/kit does not fall within the scope of the European Union directives regarding electromagnetic compatibility, restricted substances (RoHS), recycling (WEEE), FCC, CE or UL, and therefore may not meet the technical requirements of these directives or other related directives.

Should this evaluation board/kit not meet the specifications indicated in the User's Guide, the board/kit may be returned within 30 days from the date of delivery for a full refund. **THE FOREGOING WARRANTY IS THE EXCLUSIVE WARRANTY MADE BY SELLER TO BUYER AND IS IN LIEU OF ALL OTHER WARRANTIES, EXPRESSED, IMPLIED, OR STATUTORY, INCLUDING ANY WARRANTY OF MERCHANTABILITY OR FITNESS FOR ANY PARTICULAR PURPOSE.**

The user assumes all responsibility and liability for proper and safe handling of the goods. Further, the user indemnifies TI from all claims arising from the handling or use of the goods. Due to the open construction of the product, it is the user's responsibility to take any and all appropriate precautions with regard to electrostatic discharge.

EXCEPT TO THE EXTENT OF THE INDEMNITY SET FORTH ABOVE, NEITHER PARTY SHALL BE LIABLE TO THE OTHER FOR ANY INDIRECT, SPECIAL, INCIDENTAL, OR CONSEQUENTIAL DAMAGES.

TI currently deals with a variety of customers for products, and therefore our arrangement with the user **is not exclusive.**

TI assumes **no liability for applications assistance, customer product design, software performance, or infringement of patents or services described herein.**

Please read the User's Guide and, specifically, the Warnings and Restrictions notice in the User's Guide prior to handling the product. This notice contains important safety information about temperatures and voltages. For additional information on TI's environmental and/or safety programs, please contact the TI application engineer or visit www.ti.com/esh.

No license is granted under any patent right or other intellectual property right of TI covering or relating to any machine, process, or combination in which such TI products or services might be or are used.

FCC Warning

This evaluation board/kit is intended for use for **ENGINEERING DEVELOPMENT, DEMONSTRATION, OR EVALUATION PURPOSES ONLY** and is not considered by TI to be a finished end-product fit for general consumer use. It generates, uses, and can radiate radio frequency energy and has not been tested for compliance with the limits of computing devices pursuant to part 15 of FCC rules, which are designed to provide reasonable protection against radio frequency interference. Operation of this equipment in other environments may cause interference with radio communications, in which case the user at his own expense will be required to take whatever measures may be required to correct this interference.

EVM Warnings and Restrictions

It is important to operate this EVM within the input voltage range of 36 V to 75 V and the output voltage range of 3.3 V .

Exceeding the specified input range may cause unexpected operation and/or irreversible damage to the EVM. If there are questions concerning the input range, please contact a TI field representative prior to connecting the input power.

Applying loads outside of the specified output range may result in unintended operation and/or possible permanent damage to the EVM. Please consult the EVM User's Guide prior to connecting any load to the EVM output. If there is uncertainty as to the load specification, please contact a TI field representative.

During normal operation, some circuit components may have case temperatures greater than 60° C. The EVM is designed to operate properly with certain components above 60° C as long as the input and output ranges are maintained. These components include but are not limited to linear regulators, switching transistors, pass transistors, and current sense resistors. These types of devices can be identified using the EVM schematic located in the EVM User's Guide. When placing measurement probes near these devices during operation, please be aware that these devices may be very warm to the touch.

Mailing Address: Texas Instruments, Post Office Box 655303, Dallas, Texas 75265
Copyright © 2010, Texas Instruments Incorporated

IMPORTANT NOTICE

Texas Instruments Incorporated and its subsidiaries (TI) reserve the right to make corrections, modifications, enhancements, improvements, and other changes to its products and services at any time and to discontinue any product or service without notice. Customers should obtain the latest relevant information before placing orders and should verify that such information is current and complete. All products are sold subject to TI's terms and conditions of sale supplied at the time of order acknowledgment.

TI warrants performance of its hardware products to the specifications applicable at the time of sale in accordance with TI's standard warranty. Testing and other quality control techniques are used to the extent TI deems necessary to support this warranty. Except where mandated by government requirements, testing of all parameters of each product is not necessarily performed.

TI assumes no liability for applications assistance or customer product design. Customers are responsible for their products and applications using TI components. To minimize the risks associated with customer products and applications, customers should provide adequate design and operating safeguards.

TI does not warrant or represent that any license, either express or implied, is granted under any TI patent right, copyright, mask work right, or other TI intellectual property right relating to any combination, machine, or process in which TI products or services are used. Information published by TI regarding third-party products or services does not constitute a license from TI to use such products or services or a warranty or endorsement thereof. Use of such information may require a license from a third party under the patents or other intellectual property of the third party, or a license from TI under the patents or other intellectual property of TI.

Reproduction of TI information in TI data books or data sheets is permissible only if reproduction is without alteration and is accompanied by all associated warranties, conditions, limitations, and notices. Reproduction of this information with alteration is an unfair and deceptive business practice. TI is not responsible or liable for such altered documentation. Information of third parties may be subject to additional restrictions.

Resale of TI products or services with statements different from or beyond the parameters stated by TI for that product or service voids all express and any implied warranties for the associated TI product or service and is an unfair and deceptive business practice. TI is not responsible or liable for any such statements.

TI products are not authorized for use in safety-critical applications (such as life support) where a failure of the TI product would reasonably be expected to cause severe personal injury or death, unless officers of the parties have executed an agreement specifically governing such use. Buyers represent that they have all necessary expertise in the safety and regulatory ramifications of their applications, and acknowledge and agree that they are solely responsible for all legal, regulatory and safety-related requirements concerning their products and any use of TI products in such safety-critical applications, notwithstanding any applications-related information or support that may be provided by TI. Further, Buyers must fully indemnify TI and its representatives against any damages arising out of the use of TI products in such safety-critical applications.

TI products are neither designed nor intended for use in military/aerospace applications or environments unless the TI products are specifically designated by TI as military-grade or "enhanced plastic." Only products designated by TI as military-grade meet military specifications. Buyers acknowledge and agree that any such use of TI products which TI has not designated as military-grade is solely at the Buyer's risk, and that they are solely responsible for compliance with all legal and regulatory requirements in connection with such use.

TI products are neither designed nor intended for use in automotive applications or environments unless the specific TI products are designated by TI as compliant with ISO/TS 16949 requirements. Buyers acknowledge and agree that, if they use any non-designated products in automotive applications, TI will not be responsible for any failure to meet such requirements.

Following are URLs where you can obtain information on other Texas Instruments products and application solutions:

Products		Applications	
Amplifiers	amplifier.ti.com	Audio	www.ti.com/audio
Data Converters	dataconverter.ti.com	Automotive	www.ti.com/automotive
DLP® Products	www.dlp.com	Communications and Telecom	www.ti.com/communications
DSP	dsp.ti.com	Computers and Peripherals	www.ti.com/computers
Clocks and Timers	www.ti.com/clocks	Consumer Electronics	www.ti.com/consumer-apps
Interface	interface.ti.com	Energy	www.ti.com/energy
Logic	logic.ti.com	Industrial	www.ti.com/industrial
Power Mgmt	power.ti.com	Medical	www.ti.com/medical
Microcontrollers	microcontroller.ti.com	Security	www.ti.com/security
RFID	www.ti-rfid.com	Space, Avionics & Defense	www.ti.com/space-avionics-defense
RF/IF and ZigBee® Solutions	www.ti.com/lprf	Video and Imaging	www.ti.com/video
		Wireless	www.ti.com/wireless-apps

Mailing Address: Texas Instruments, Post Office Box 655303, Dallas, Texas 75265
Copyright © 2010, Texas Instruments Incorporated



Компания «ЭлектроПласт» предлагает заключение долгосрочных отношений при поставках импортных электронных компонентов на взаимовыгодных условиях!

Наши преимущества:

- Оперативные поставки широкого спектра электронных компонентов отечественного и импортного производства напрямую от производителей и с крупнейших мировых складов;
- Поставка более 17-ти миллионов наименований электронных компонентов;
- Поставка сложных, дефицитных, либо снятых с производства позиций;
- Оперативные сроки поставки под заказ (от 5 рабочих дней);
- Экспресс доставка в любую точку России;
- Техническая поддержка проекта, помощь в подборе аналогов, поставка прототипов;
- Система менеджмента качества сертифицирована по Международному стандарту ISO 9001;
- Лицензия ФСБ на осуществление работ с использованием сведений, составляющих государственную тайну;
- Поставка специализированных компонентов (Xilinx, Altera, Analog Devices, Intersil, Interpoint, Microsemi, Aeroflex, Peregrine, Syfer, Eurofarad, Texas Instrument, Miteq, Cobham, E2V, MA-COM, Hittite, Mini-Circuits, General Dynamics и др.);

Помимо этого, одним из направлений компании «ЭлектроПласт» является направление «Источники питания». Мы предлагаем Вам помощь Конструкторского отдела:

- Подбор оптимального решения, техническое обоснование при выборе компонента;
- Подбор аналогов;
- Консультации по применению компонента;
- Поставка образцов и прототипов;
- Техническая поддержка проекта;
- Защита от снятия компонента с производства.



Как с нами связаться

Телефон: 8 (812) 309 58 32 (многоканальный)

Факс: 8 (812) 320-02-42

Электронная почта: org@eplast1.ru

Адрес: 198099, г. Санкт-Петербург, ул. Калинина, дом 2, корпус 4, литера А.