

Analog Devices Welcomes Hittite Microwave Corporation

NO CONTENT ON THE ATTACHED DOCUMENT HAS CHANGED



THIS PAGE INTENTIONALLY LEFT BLANK

Typical Applications

The HMC550A / HMC550AE is ideal for:

- RFID & Electronic Toll Collection (ETC)
- Tags, Handsets & Portables
- ISM, WLAN, WiMAX & WiBro
- Automotive Telematics
- Test Equipment

Features

- Failsafe Operation - "On" When Unpowered
- Wide Vdd Range: 1.2V to 5V
- Very Low On State Current: 200 nA
- Low Insertion Loss: 0.7 dB
- High IP3: +52 dBm
- Compact SOT26 SMT Package

Functional Diagram

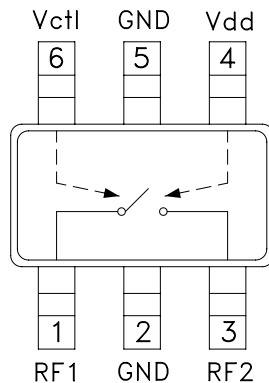

General Description

The HMC550A and HMC550AE are low-cost SPST Failsafe switches in 6-lead SOT26 plastic packages for use in switching applications which require low insertion loss and very low current consumption. With 0.7 dB typical loss, these devices can control signals from DC to 6 GHz and are especially suited for IF and RF applications including RFID, ISM, automotive and battery powered tags and portables. RF1 and RF2 are reflective opens when "Off". The switch requires a minimal amount of DC current in the "On" state, and offers compatibility with CMOS and some TTL logic families. The failsafe topology results in the switch being normally "On", i.e. low insertion loss from RF1 to RF2, when no DC bias is applied.

Electrical Specifications

$T_A = +25^\circ \text{C}$, $V_{dd} = +3.3 \text{Vdc}$, $V_{ctl} = 0/+3.3 \text{Vdc}$ (Unless Otherwise Stated), 50 Ohm System

Parameter	Frequency	Min.	Typ.	Max.	Units
Insertion Loss	DC - 6.0 GHz		0.7	0.9	dB
Isolation	DC - 2.0 GHz	15	25		dB
	DC - 6.0 GHz	8	12		dB
Return Loss	DC - 6.0 GHz		20		dB
Input Power for 0.1 dB Compression	$V_{ctl} = 0/+3.3\text{V}$ 0.5 - 6.0 GHz	28	32		dBm
Input Third Order Intercept (Two-tone Input Power = +17 dBm Each Tone)	$V_{ctl} = 0/+3.3\text{V}$ 0.5 - 6.0 GHz		52		dBm
Switching Characteristics	DC - 6.0 GHz	t_{RISE}, t_{FALL} (10/90% RF)	20		ns
		t_{ON}, t_{OFF} (50% CTL to 10/90% RF)	30		ns

$T_A = +25^\circ \text{C}$, V_{ctl} & V_{dd} Unpowered

Insertion Loss	DC - 6.0 GHz		0.7	0.9	dB
Return Loss	DC - 6.0 GHz		20		dB
Input Power for 0.1 dB Compression	0.5 - 6.0 GHz	28	33		dBm
Input Third Order Intercept (Two-tone Input Power = +17 dBm Each Tone)	0.5 - 0.6 GHz		52		dBm



**GaAs MMIC SPST
FAILSAFE SWITCH, DC - 6 GHz**

Insertion Loss

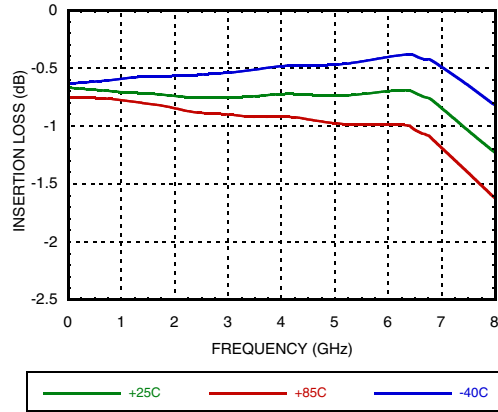

Return Loss

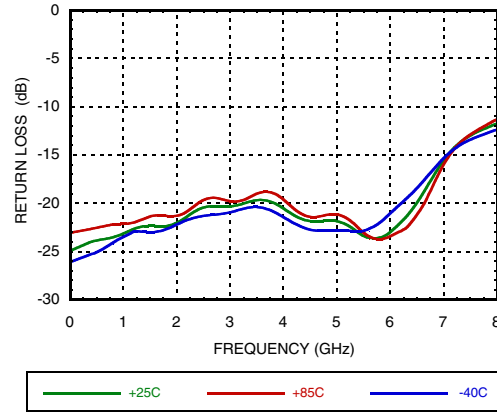

Isolation

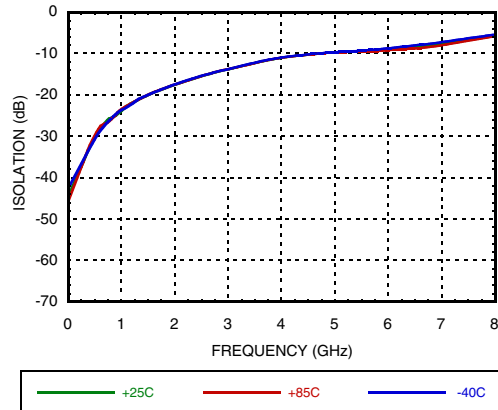

Input IP3 vs. Temperature

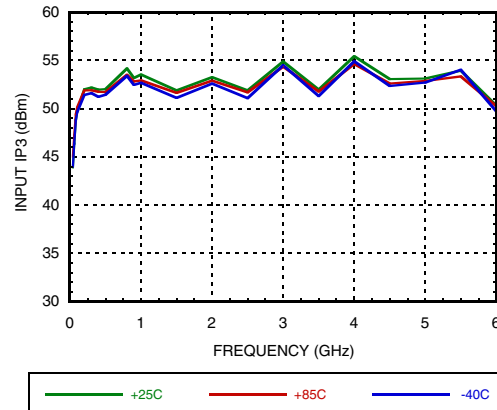

Input P0.1dB vs. Temperature

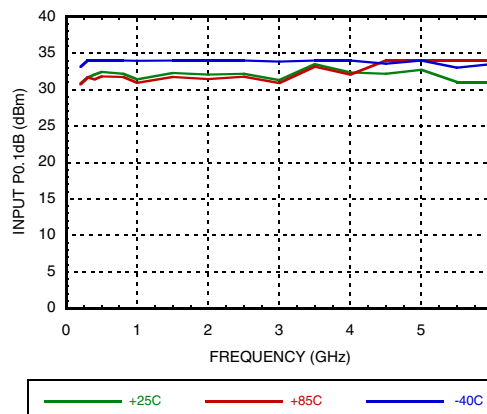

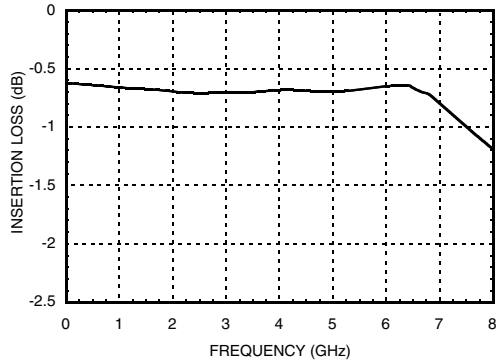
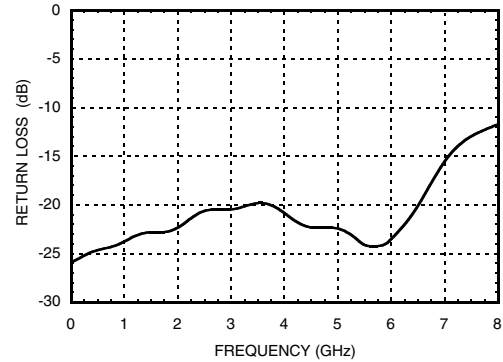
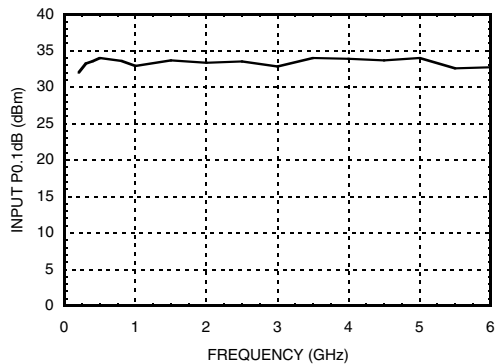
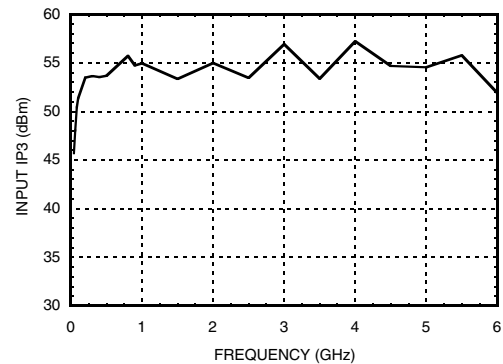
Insertion Loss, Power Off

Return Loss, Power Off

Input P0.1dB, Power Off

Input IP3, Power Off

Operating Conditions

Vdd & Vctl = 0 Vdc to +5 Vdc; Vctl_max = Vdd + 0.2 Vdc; Idd & Ictl = 0.1 μ A, Typical

Conditions	Vdd - Vctl \geq + 1.2 Vdc	-0.2 Vdc < Vdd - Vctl < +0.4 Vdc
RF1 - RF2	OFF	ON

Examples of Typical Operating Conditions - Idd & Ictl = 0.1 μ A, Typical

Vdd (V)	0 (Unpowered)	1.6		2.2		3.3		5.0	
Vctl (V)	0 (Unpowered)	0	> 1.2	< 1.0	> 1.8	< 2.1	> 2.9	< 3.8	> 4.6
RF1 - RF2	ON	OFF	ON	OFF	ON	OFF	ON	OFF	ON



GaAs MMIC SPST FAILSAFE SWITCH, DC - 6 GHz

Absolute Maximum Ratings

RF Input Power (Vctl = 0/+3.3V)	+34 dBm
Supply Voltage (Vdd)	+12 Vdc
Control Voltage Range (Vctl)	-0.2 to +(Vdd + 0.2) Vdc
Channel Temperature	150 °C
Continuous P _{diss} (T= 85 °C) (derate 5.54 mW/ °C above 85°C)	0.360 W
Thermal Resistance	180.5 °C/W
Storage Temperature	-65 to +150 °C
Operating Temperature	-40 to +85 °C
ESD Sensitivity (HBM)	Class 1A

DC blocks are required at ports RF1 and RF2.



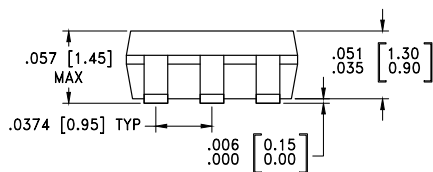
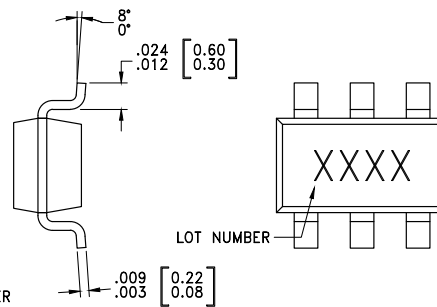
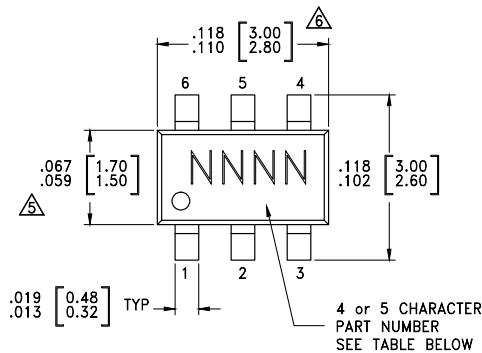

ELECTROSTATIC SENSITIVE DEVICE
OBSERVE HANDLING PRECAUTIONS

Outline Drawing



NOTES:

- LEADFRAME MATERIAL: COPPER ALLOY
- DIMENSIONS ARE IN INCHES [MILLIMETERS].
-  DIMENSION DOES NOT INCLUDE MOLDFLASH OF 0.15mm PER SIDE.
-  DIMENSION DOES NOT INCLUDE MOLDFLASH OF 0.25mm PER SIDE.
- ALL GROUND LEADS MUST BE SOLDERED TO PCB RF GROUND.

Package Information

Part Number	Package Body Material	Lead Finish	MSL Rating	Package Marking ^[3]
HMC550A	Low Stress Injection Molded Plastic	Sn/Pb Solder	MSL1 ^[1]	550A XXXX
HMC550AE	RoHS-compliant Low Stress Injection Molded Plastic	100% matte Sn	MSL1 ^[2]	550AE XXXX

[1] Max peak reflow temperature of 235 °C

[2] Max peak reflow temperature of 260 °C

[3] 4-Digit lot number XXXX

Pin Descriptions

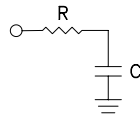
Pin Number	Function	Description	Interface Schematic
1, 3	RF1, RF2	These pins are DC coupled and matched to 50 Ohms. Blocking capacitors are required.	
2, 5	GND	These pins must be connected to RF ground.	
4	Vdd	Supply Voltage	
6	Vctl	See truth and control voltage tables.	

Typical Application Circuit

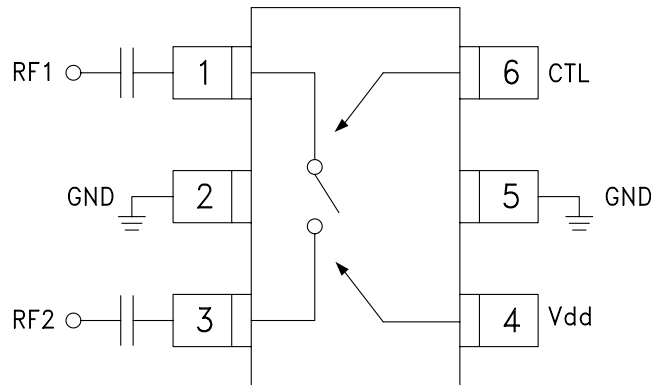

Note:

1. DC Blocking capacitors are required for each RF port as shown. Capacitor value determines lowest frequency of operation.

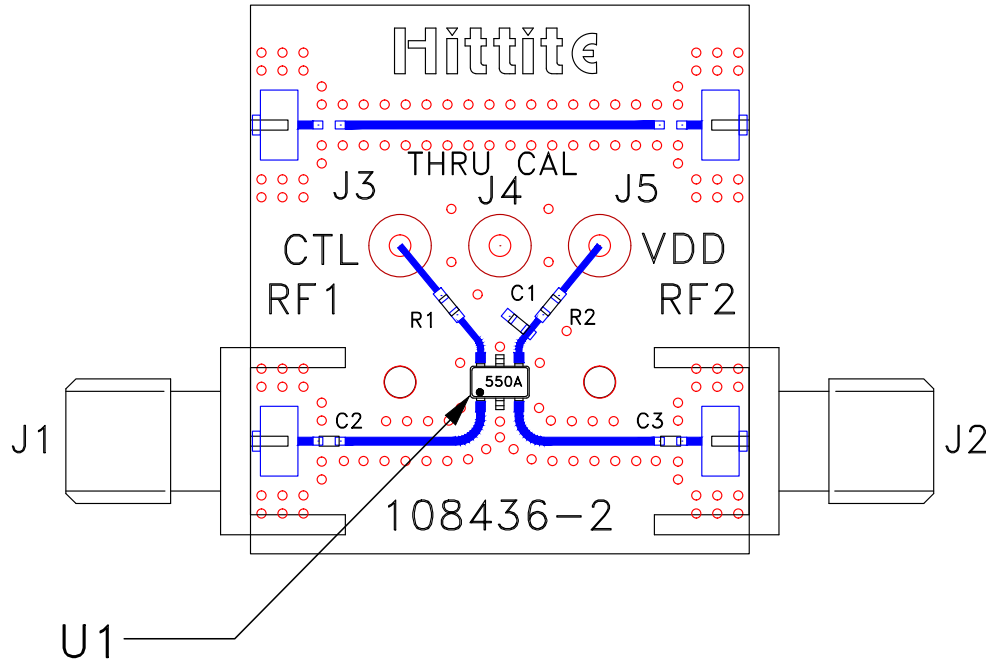
Evaluation PCB

List of Materials for Evaluation PCB 109266 - HMC550A^[1]

Item	Description
J1 - J2	PCB Mount SMA RF Connector
J3 - J5	DC Pin
C1	1,000 pF Capacitor, 0402 Pkg.
C2 - C3	100 pF capacitor, 0402 Pkg.
R1, R2	100 Ohm Resistor, 0402 Pkg.
U1	HMC550A / HMC550AE SPST Switch
PCB ^[2]	108436 Evaluation PCB

[1] Reference this number when ordering complete evaluation PCB

[2] Circuit Board Material: Rogers 4350

The circuit board used in the final application should be generated with proper RF circuit design techniques. Signal lines at the RF port should have 50 Ohm impedance and the package ground leads should be connected directly to the ground plane similar to that shown above. The evaluation circuit board shown above is available from Hittite Microwave Corporation upon request.



Компания «ЭлектроПласт» предлагает заключение долгосрочных отношений при поставках импортных электронных компонентов на взаимовыгодных условиях!

Наши преимущества:

- Оперативные поставки широкого спектра электронных компонентов отечественного и импортного производства напрямую от производителей и с крупнейших мировых складов;
- Поставка более 17-ти миллионов наименований электронных компонентов;
- Поставка сложных, дефицитных, либо снятых с производства позиций;
- Оперативные сроки поставки под заказ (от 5 рабочих дней);
- Экспресс доставка в любую точку России;
- Техническая поддержка проекта, помощь в подборе аналогов, поставка прототипов;
- Система менеджмента качества сертифицирована по Международному стандарту ISO 9001;
- Лицензия ФСБ на осуществление работ с использованием сведений, составляющих государственную тайну;
- Поставка специализированных компонентов (Xilinx, Altera, Analog Devices, Intersil, Interpoint, Microsemi, Aeroflex, Peregrine, Syfer, Eurofarad, Texas Instrument, Miteq, Cobham, E2V, MA-COM, Hittite, Mini-Circuits, General Dynamics и др.);

Помимо этого, одним из направлений компании «ЭлектроПласт» является направление «Источники питания». Мы предлагаем Вам помощь Конструкторского отдела:

- Подбор оптимального решения, техническое обоснование при выборе компонента;
- Подбор аналогов;
- Консультации по применению компонента;
- Поставка образцов и прототипов;
- Техническая поддержка проекта;
- Защита от снятия компонента с производства.



Как с нами связаться

Телефон: 8 (812) 309 58 32 (многоканальный)

Факс: 8 (812) 320-02-42

Электронная почта: org@eplast1.ru

Адрес: 198099, г. Санкт-Петербург, ул. Калинина, дом 2, корпус 4, литера А.