



Industry's first  
modular fuse block  
simplifies design and  
enhances safety

**Bussmann**  
by **EAT•N**

Increase flexibility and electrical safety with Bussmann's snap-together Class H(K), J, and R knifeblade fuse blocks.

protection solutions to meet every application need, Eaton and Bussmann offer unmatched leadership in circuit protection.

As the only company with a complete portfolio of circuit

[More expertise. More solutions. Expect more.](#)



Leadership in Circuit Protection.

# The only company that can provide a complete circuit protection solution for all applications.

## Only Eaton can deliver...

- The most diverse solutions to mitigate arc flash energy to keep people and equipment safe
- The smallest and most cost effective way to meet selective coordination requirements
- The most experienced, time-tested solutions to meet national & local code requirements
- The easiest specifications with the most tested fuse/circuit breaker and circuit breaker/circuit breaker series rated combinations
- The only one-stop shop to solve your design challenges using our expertise and an unmatched portfolio

The Eaton advantage.

## Powering business worldwide

As a global diversified power management company, we help customers worldwide manage the power needed for buildings, aircraft, trucks, cars, machinery and businesses.

Eaton's innovative technologies help customers manage electrical, hydraulic and mechanical power more reliably, efficiently, safely and sustainably.

We provide integrated solutions that help make energy, in all its forms, more practical and accessible.

With 2012 sales of \$16.3 billion, Eaton has approximately 103,000 employees around the world and sells products in more than 175 countries.

[Eaton.com](http://Eaton.com)

**EATON**

*Powering Business Worldwide*

Bussmann knifeblade fuse blocks offer advantages you can't find anywhere else.



## Modularity

The only snap-together design on the market permits assembly of required poles at point-of-use. Factory assembled two- and three-pole configurations are also available.



## Best Ratings

All fuse blocks meet UL creep and clearance requirements for Industrial Control Circuits (UL 508, UL 845). 200 to 600A blocks meet the higher UL Industrial Power Distribution Standards (UL 98, UL 67, UL 489, UL 891, and UL 869A).



## Ease-of-Use

Optional high-clarity, see-through finger-safe covers with test probe holes make routine maintenance activities easy. No need to open the cover to inspect wire terminations or to take thermography measurements. Available with any Class H(K), J or R fuse block.



## Safety

For added safety and convenience, only Bussmann offers optional IP20 finger-safe covers across the entire knifeblade fuse block product line. Built-in lockout/ tagout feature improves safety. Blown fuse indication option on fuse cover assists in troubleshooting, while standard phase barriers between poles enhance safety.



## QuikShip Services

In stock for QuikShip Everyday Service - 90% of orders ship within 24 hours. QuikShip Emergency Service ensures availability 24/7, 365 with "Next flight out" courier service.



## Features and Benefits

- Integral dovetails allow assembly of multiple poles at point-of-use for greater application flexibility
- Factory assembled two- and three-pole configurations available
- Up to four mounting holes per pole increase installation flexibility
- Standard phase barriers between poles for additional safety
- Design meets UL creep and clearance requirements for Industrial Power Circuits (UL 508 and UL 845)
- 200 to 600A blocks meet the higher UL creep and clearance requirements for Power Distribution Standards (UL 98, UL 67, UL 489, UL 891 and UL 869A)
- Optional IP20 finger-safe covers available on entire knifeblade fuse block product line:
  - High-clarity see-through covers allow for inspecting wire terminations or thermography measurements without removing cover
  - Probe holes included for easy, safer testing and troubleshooting
  - Built-in lockout/tagout feature improves safety
- Standard fuse clip reinforcing springs enhance electrical contact

## Specifications

### Agency information:

Blocks - UL - Listed cULus E14853 – IZLT & IZLT7  
 CSA - Certified 47235 – 6225-01  
 Covers - UL - Listed UL E58836 – JDVS2

### Ratings:

Volts - 250V, 600V  
 Amps - 70-600A  
 SCCR - 200kA (Class J & R)  
 10kA (Class H & K)

### Flammability ratings:

Blocks - UL 94V0, self-extinguishing  
 Covers - UL 94HB, self-extinguishing

### Operating and storage temperature range:

Blocks - -40°C to 120°C  
 Covers - Non-indicating covers -40°C to 120°C  
 - Indicating covers -20°C to 90°C

### Materials:

Base - Thermoplastic  
 Box Lug Terminals - Tin-plated aluminum

### Wire:\*

Cu/Al – 75°C/90°C (100 - 200A)  
 Cu/Al – 75°C only (400 - 600A)\*\*

\*Higher temperature rated wire can be used with appropriate derating.  
 \*\*400A Class J double box lug rated for 75°C/90°C Cu/Al.

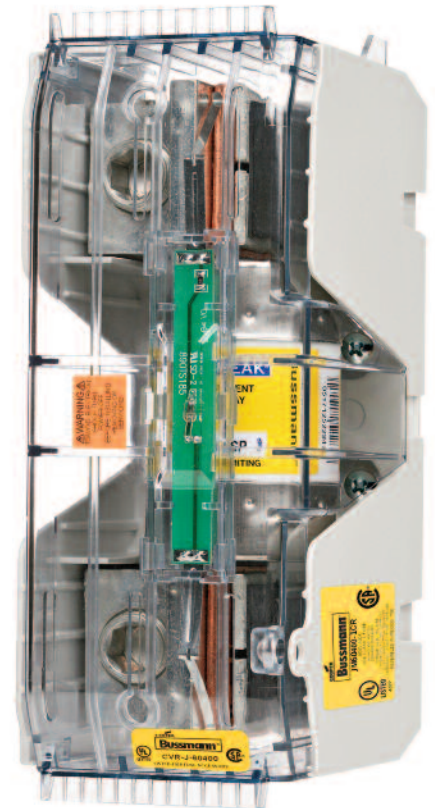

## Features

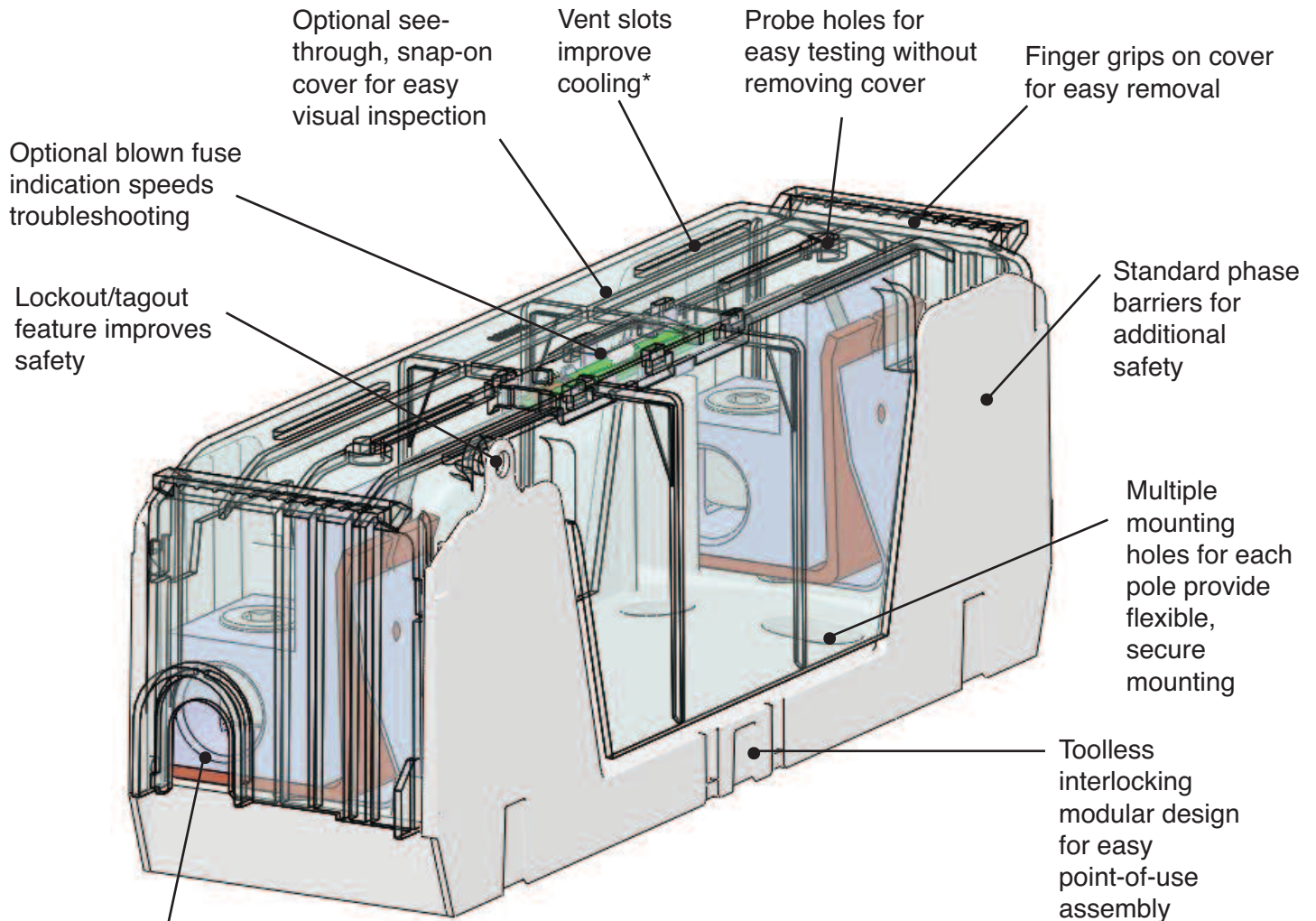

Finger-safe wire entry with cutout tabs for larger wires on all versions

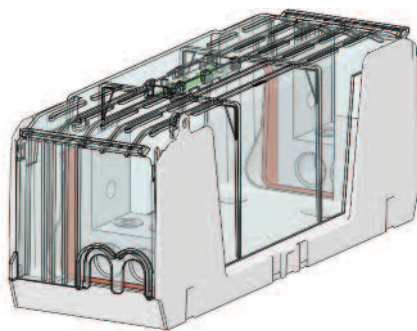

### 600A Version

(double box lug standard for easier wiring with smaller, dual conductors)

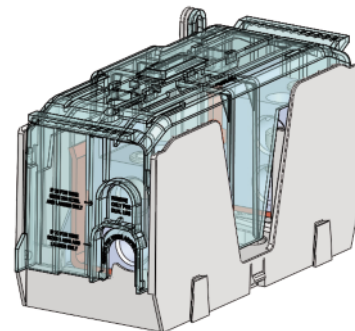

### 400A Class J Version

(JM60400-\_MW22 with double box lug for easier wiring with smaller, dual conductors)

\*No fuse derating necessary.

# Knifeblade Fuse Block Part Number Table - 250 and 600V Class H(K) & R

**Bussmann**  
by **Eaton**

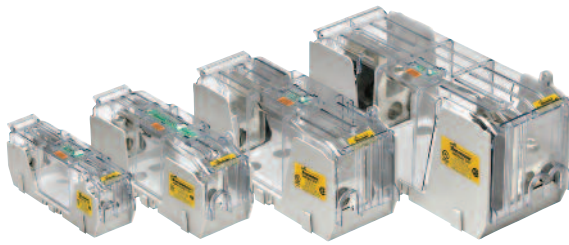

250V Class H(K) and R

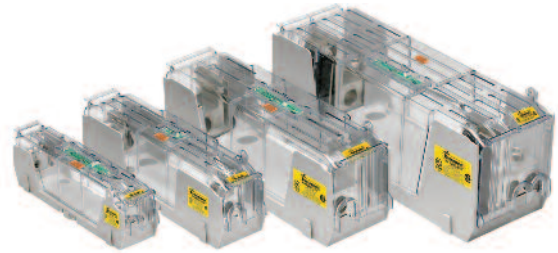

600V Class H(K) and R

Catalog Number		Covers*		Volts	Fuse Range (amps)	Number of Poles	Wire Range (solid and stranded)***	Wire Range (fine stranded Cu)	Torque N•m (Lb-In)	Bussmann Fuses
Class H(K)	Class R	w/o Indication	w/ Indication							
HM25100-1CR	RM25100-1CR	CVR-RH-25100	CVRI-RH-25100	250	70-100	1	–	1-3 AWG	6.2 (55)	Class H(K): NON
HM25100-2CR	RM25100-2CR					2	1/0-3 AWG; (2) Cu 4-6 AWG	4-6 AWG	5.6 (50)	
HM25100-3CR	RM25100-3CR					3	4-6 AWG; (2) Cu 8 AWG	8 AWG	5.1 (45)	
HM25200-1CR	RM25200-1CR	CVR-RH-25200	CVRI-RH-25200		110-200	1	250 MCM-1 AWG	3/0-1 AWG	42 (375)	Class R: LPN-RK_SP LPN-RK_SPI**
HM25200-2CR	RM25200-2CR					2	8 AWG; (2) Cu 10-14 AWG	–	4.5 (40)	
HM25200-3CR	RM25200-3CR					3	Cu 10-14 AWG; Al 10-12 AWG	–	4.0 (35)	
HM25400-1CR	RM25400-1CR	CVR-RH-25400	CVRI-RH-25400		225-400	1	600kcmil	N/A	57 (500)	FRN-R KTN-R
HM25400-2CR	RM25400-2CR					2	500kcmil-4 AWG		51 (450)	
HM25400-3CR	RM25400-3CR					3	(2) Cu 3/0 - 4 AWG (2) Al 3/0 - 4 AWG		57 (500) 34 (300)	
HM25600-1CR	RM25600-1CR	CVR-RH-25600	CVRI-RH-25600	450-600	1	(2) 500kcmil-4 AWG	N/A	51 (450)		
HM25600-2CR	RM25600-2CR				2					
HM25600-3CR	RM25600-3CR				3					
HM60100-1CR	RM60100-1CR	CVR-RH-60100	CVRI-RH-60100	600	70-100	1	–	1-3 AWG	6.2 (55)	Class H(K): NOS
HM60100-2CR	RM60100-2CR					2	1/0-3 AWG; (2) Cu 4-6 AWG	4-6 AWG	5.6 (50)	
HM60100-3CR	RM60100-3CR					3	4-6 AWG; (2) Cu 8 AWG	8 AWG	5.1 (45)	
HM60200-1CR	RM60200-1CR	CVR-RH-60200	CVRI-RH-60200		110-200	1	250 MCM-1 AWG	3/0-1 AWG	42 (375)	Class R: LPS-RK_SP LPS-RK_SPI**
HM60200-2CR	RM60200-2CR					2	8 AWG; (2) Cu 10-14 AWG	–	4.5 (40)	
HM60200-3CR	RM60200-3CR					3	Cu 10-14 AWG; Al 10-12 AWG	–	4.0 (35)	
HM60400-1CR	RM60400-1CR	CVR-RH-60400	CVRI-RH-60400		225-400	1	600kcmil	N/A	57 (500)	FRS-R KTS-R KWS-R PVS-R
HM60400-2CR	RM60400-2CR					2	500kcmil-4 AWG		51 (450)	
HM60400-3CR	RM60400-3CR					3	(2) Cu 3/0 - 4 AWG (2) Al 3/0 - 4 AWG		57 (500) 34 (300)	
HM60600-1CR	RM60600-1CR	CVR-RH-60600	CVRI-RH-60600	450-600	1	(2) 500kcmil-4 AWG	N/A	51 (450)		
HM60600-2CR	RM60600-2CR				2					
HM60600-3CR	RM60600-3CR				3					

\*Covers sold separately. Blown fuse indication requires 90 volts minimum and closed circuit to operate.

\*\*With *easyID*™ blown fuse indication.

\*\*\*Ratings for copper and aluminum wire except where otherwise noted.



Class J

Catalog Number	Covers*		Volts	Fuse Range (amps)	Number of Poles	Wire Range (solid and stranded)***	Wire Range (fine stranded)	Torque N•m (Lb-In)	Bussmann Fuses
	w/o Indication	w/ Indication							
JM60100-1CR	CVR-J-60100	CVRI-J-60100	600	70-100	1	–	1-3 AWG	6.2 (55)	LPJ_SP LPJ_SPI** JKS DFJ
JM60100-2CR					2	1/0-3 AWG; (2) Cu 4-6 AWG	4-6 AWG	5.6 (50)	
JM60100-3CR					3	4-6 AWG; (2) Cu 8 AWG 8 AWG; (2) Cu 10-14 AWG Cu 10-14 AWG; Al 10-12 AWG	– –	4.5 (40) 4.0 (35)	
JM60200-1CR	CVR-J-60200	CVRI-J-60200		110-200	1	250 MCM-1 AWG	3/0-1 AWG	42 (375)	
JM60200-2CR					2	2-6 AWG; (2) Cu 2-6 AWG	2-6 AWG	31 (275)	
JM60200-3CR					3				
JM60400-1CR	CVR-J-60400-M	CVRI-J-60400-M		225-400	1	600kcmil	N/A	57 (500)	
JM60400-2CR					2	500kcmil-4 AWG		51 (450)	
JM60400-3CR					3	(2) Cu 3/0 - 4 AWG (2) Al 3/0 - 4 AWG		57 (500) 34 (300)	
JM60400-1MW22†					1	(2) 350kcmil-1 AWG (2) 2 AWG - 6 AWG		42 (375)	
JM60400-2MW22†			2		51 (275)				
JM60400-3MW22†			3						
JM60600-1CR			CVR-J-60600		CVRI-J-60600	450-600		1	(2) 500kcmil-4 AWG
JM60600-2CR	2								
JM60600-3CR	3								

\*Covers sold separately. Blown fuse indication requires 90 volts minimum and closed circuit to operate.

\*\*With *easyID*™ blown fuse indication.

\*\*\*Ratings for copper and aluminum wire except where otherwise noted.

†400A Class J double box lug rated for 75°C/90°C Cu/Al.

## Double Box Lug Configurations

- Allows for ease of installation with smaller, more flexible wire
- Capable of achieving maximum current rating with parallel copper or aluminum wires
- Standard on all 600A blocks
- Optional on 400A Class J blocks
- Compatible with IP20 finger-safe covers††

††For Class J 400A double box lug configuration, optional cover provides IP20 finger-safe protection for dual 350kcmil-1 AWG wires or one single 350kcmil-6 AWG wire.



Optional 400A  
Class J Version  
(JM60400-  MW22)

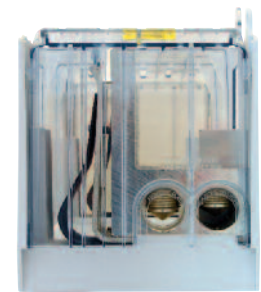

All 600A Versions

## Dimensions - mm (in)

70-100A

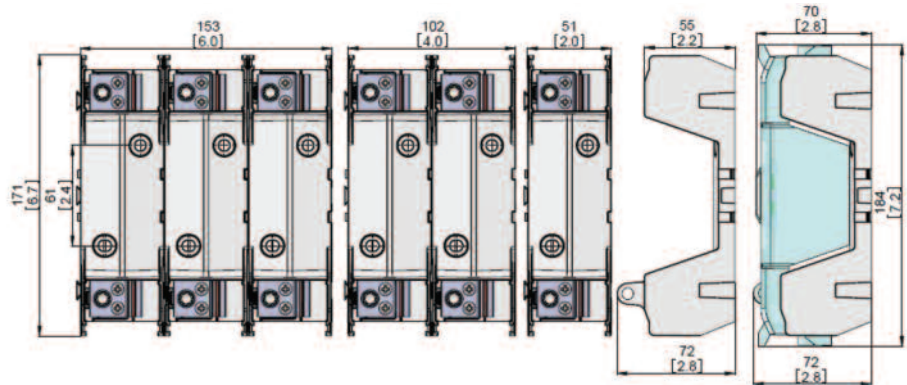
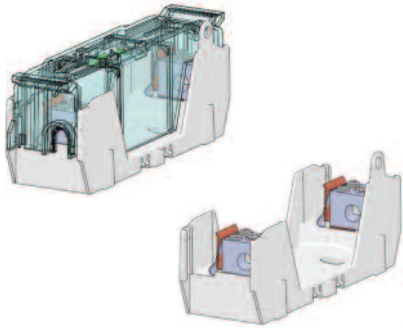

110-200A

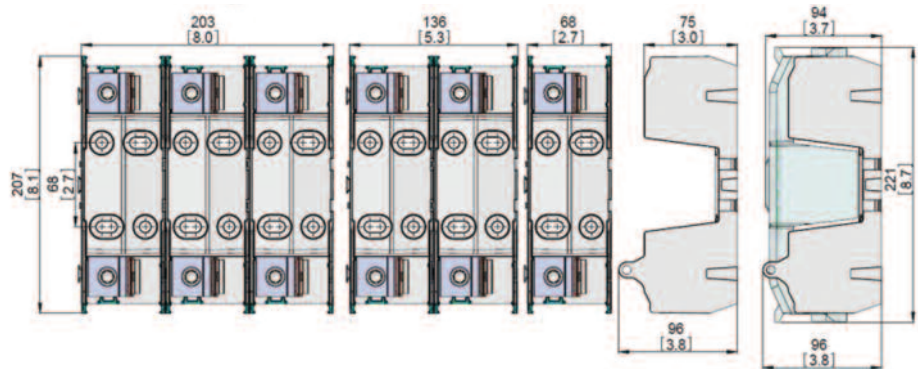
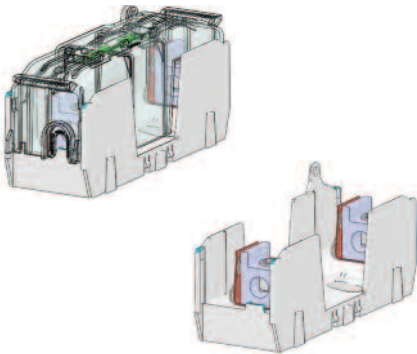

225-400A

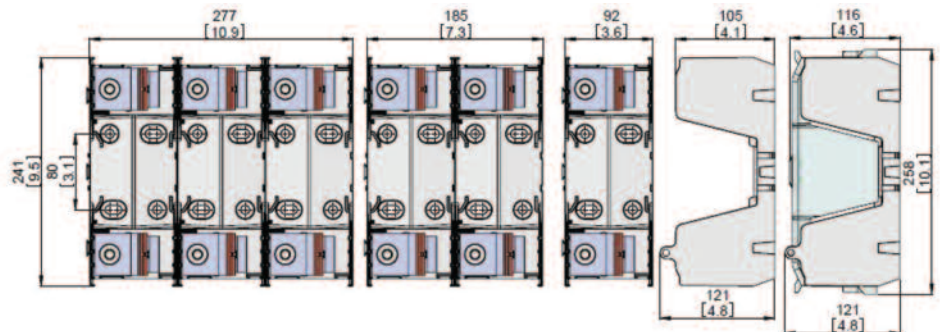
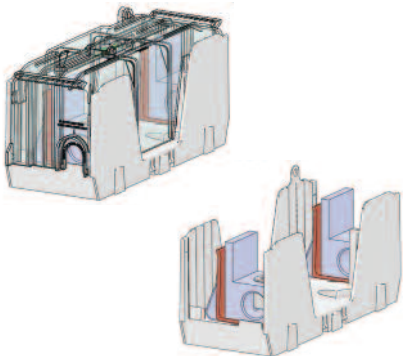

450-600A

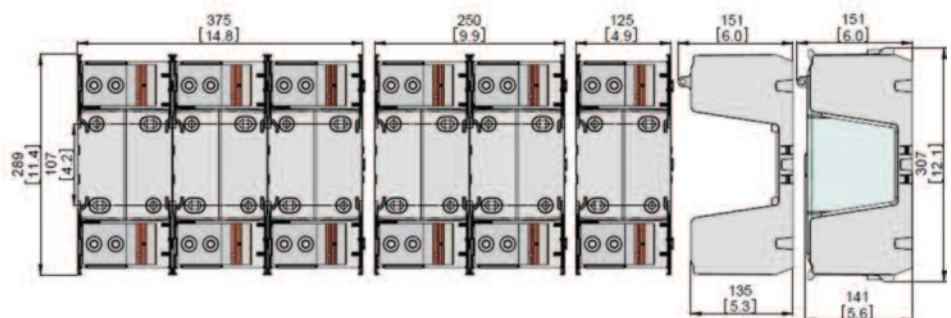
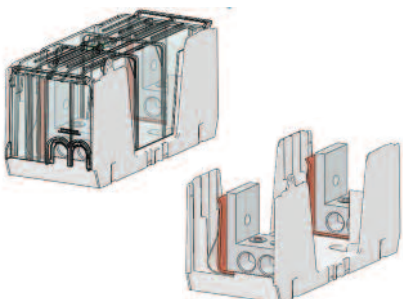





## Dimensions - mm (in)

### 70-100A

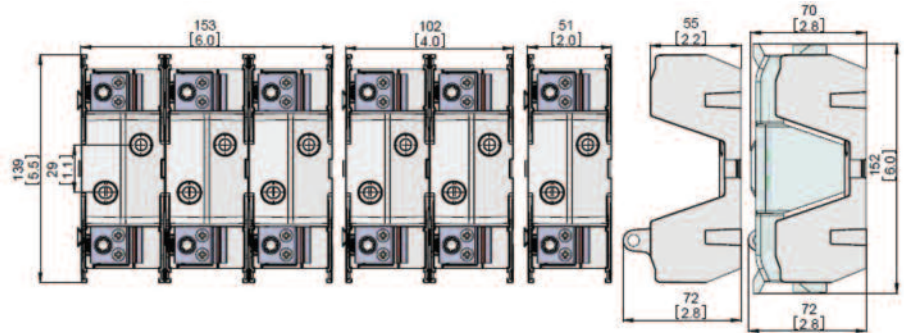
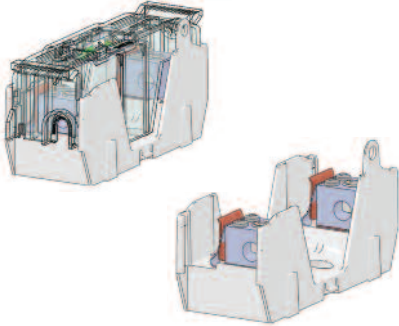

### 110-200A

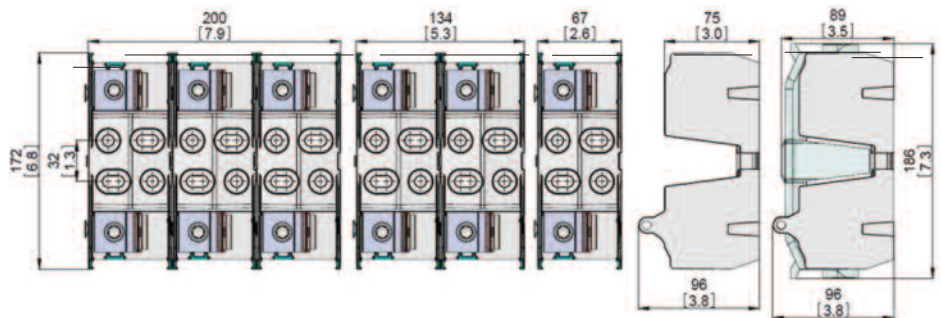
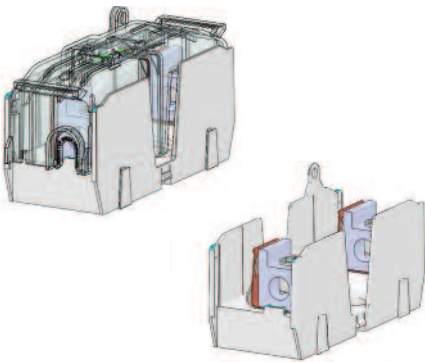



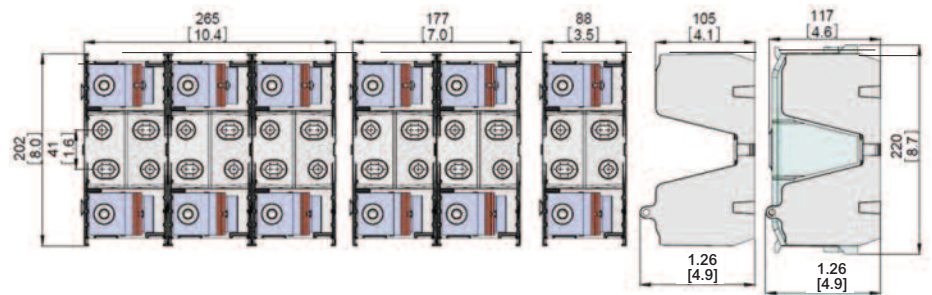
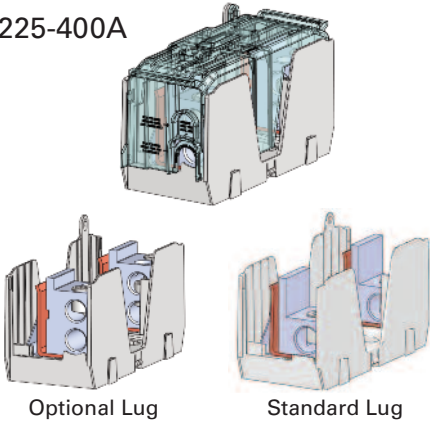



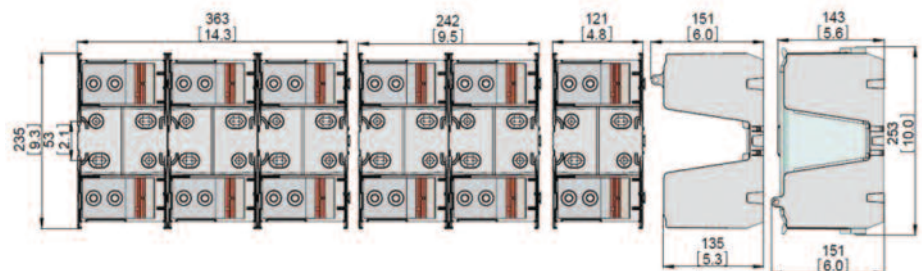
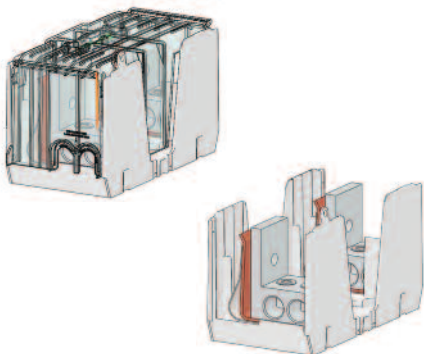

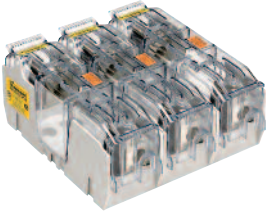

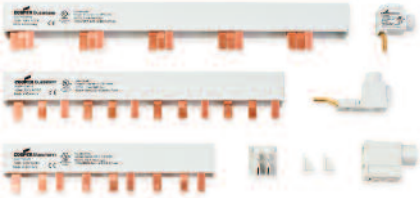
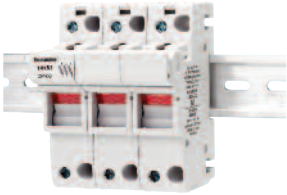

### 225-400A



### 450-600A



<p><b>Modular knifeblade fuse blocks with finger-safe covers</b></p>		<p><b>UL, IEC &amp; PV CH modular fuse holder series</b></p>	
<p><b>UL Type 1 NEMA 4X SPDs</b></p>		<p><b>Comb-bus bar accessories for CH Series fuse holders</b></p>	
<p><b>IEC CH fuse holder series</b></p>		<p><b>CUBEFuse™ holder series</b></p>	
<p><b>Class J CH fuse holder series</b></p>		<p><b>Open design ferrule fuse block series</b></p>	
<p><b>Class J JTN 600 fuse holder series</b></p>		<p><b>Finger-safe, high SCCR power distribution blocks</b></p>	
<p><b>Optima™ midget &amp; Class CC series</b></p>		<p><b>DIN-Rail terminal blocks</b></p>	
<p><b>Open design Class CC &amp; midget series</b></p>		<p><b>Compact circuit protector fused disconnect switches</b></p>	

## Customer Assistance

### Customer Satisfaction Team

Available to answer questions regarding Bussmann products & services Monday-Friday, 7:00 a.m. – 6:00 p.m. Central Time. Contact:

- Toll-free phone: 855-287-7626 (855-BUSSMANN)
- Toll-free fax: 800-544-2570
- E-mail: [busscustsat@cooperindustries.com](mailto:busscustsat@cooperindustries.com)

### Emergency and After-Hours Orders

Next flight out or will call shipment for time-critical needs. Customers pay only standard product price, rush freight charges, & modest emergency service fee. Place these orders through the Customer Satisfaction Team during regular business hours. For after-hours, contact:

- After hours 314-995-1342

### C3 – the Enhanced, Online Cooper Customer Center

Provides real time product availability, net pricing, order status & shipment tracking for: B-Line, Bussmann, Crouse-Hinds, Lighting, Power Systems & Wiring Devices. Call 877-995-5955 for log-in assistance. Available at:

- [www.cooperc3.com](http://www.cooperc3.com)

### Application Engineering

Technical assistance is available to all customers. Application support is available Monday-Friday, 7:00 a.m. – 5:00 p.m. Central Time. Contact:

- Toll-free phone: 855-287-7626 (855-BUSSMANN)
- E-mail: [fusetech@cooperindustries.com](mailto:fusetech@cooperindustries.com)

### Online Resources

Visit [www.cooperbussmann.com](http://www.cooperbussmann.com) for the following resources:

- Product search & cross-reference
- Product & technical materials
- Solutions centers for information on topical issues including arc flash, selective coordination & short-circuit current rating
- Technical tools, like our arc flash calculator
- Where to purchase Bussmann product

**Eaton's Bussmann Business**  
PO Box 14460  
St. Louis, MO 63178-44602  
[www.bussmann.com](http://www.bussmann.com)

## Your authorized distributor is:



**Eaton**  
1000 Eaton Boulevard  
Cleveland, OH 44122  
United States  
[Eaton.com](http://Eaton.com)

**EATON**  
*Powering Business Worldwide*

© 2013 Eaton  
All Rights Reserved  
Printed in USA  
Publication No. 3192  
August 2013

Eaton is a registered trademark.

All other trademarks are property of their respective owners.



Компания «ЭлектроПласт» предлагает заключение долгосрочных отношений при поставках импортных электронных компонентов на взаимовыгодных условиях!

Наши преимущества:

- Оперативные поставки широкого спектра электронных компонентов отечественного и импортного производства напрямую от производителей и с крупнейших мировых складов;
- Поставка более 17-ти миллионов наименований электронных компонентов;
- Поставка сложных, дефицитных, либо снятых с производства позиций;
- Оперативные сроки поставки под заказ (от 5 рабочих дней);
- Экспресс доставка в любую точку России;
- Техническая поддержка проекта, помощь в подборе аналогов, поставка прототипов;
- Система менеджмента качества сертифицирована по Международному стандарту ISO 9001;
- Лицензия ФСБ на осуществление работ с использованием сведений, составляющих государственную тайну;
- Поставка специализированных компонентов (Xilinx, Altera, Analog Devices, Intersil, Interpoint, Microsemi, Aeroflex, Peregrine, Syfer, Eurofarad, Texas Instrument, Miteq, Cobham, E2V, MA-COM, Hittite, Mini-Circuits, General Dynamics и др.);

Помимо этого, одним из направлений компании «ЭлектроПласт» является направление «Источники питания». Мы предлагаем Вам помощь Конструкторского отдела:

- Подбор оптимального решения, техническое обоснование при выборе компонента;
- Подбор аналогов;
- Консультации по применению компонента;
- Поставка образцов и прототипов;
- Техническая поддержка проекта;
- Защита от снятия компонента с производства.



#### Как с нами связаться

**Телефон:** 8 (812) 309 58 32 (многоканальный)

**Факс:** 8 (812) 320-02-42

**Электронная почта:** [org@eplast1.ru](mailto:org@eplast1.ru)

**Адрес:** 198099, г. Санкт-Петербург, ул. Калинина, дом 2, корпус 4, литера А.