

Filter for Backpack Mounting to KP01



KP01 Base Module
(not enclosed)

See below:
[Approvals and Compliances](#)

Description

- Component :
Snap-in version from rear-side
- 1 Function :
Line filter in standard and medical version
- For PCB mounting
- Only in combination with base-module type KP01

Characteristics

- Line filter for "backpack" mounting for modules type KP01 (snaps onto rear of KP01)
- Electrical connection done on the PCB
- Suitable for use in medical equipment according to IEC/UL 60601-1
For applications according IEC/UL 62368-1 we recommend variants with bleed resistor

Weblinks

[pdf data sheet](#), [html datasheet](#), [General Product Information](#), [Approvals](#), [Distributor-Stock-Check](#), [Accessories](#), [Detailed request for product](#)

Technical Data

Ratings IEC	1 - 10A @ Ta 40 °C / 250VAC; 50Hz
Ratings UL/CSA	1 - 10A @ Ta 40 °C / 250VAC; 60Hz
Leakage Current	standard < 0.5mA (250V / 60Hz) medical < 5 µA (250 V / 60 Hz)
Dielectric Strength	> 1.7 kVDC between L-N > 2.7 kVDC between L/N-PE Test voltage (2 sec)
Allowable Operation Temperature	-25 °C to 70 °C
Climatic Category	25/085/21 acc. to IEC 60068-1
IP-Protection	from front side IP40 acc. to IEC 60529
Protection Class	Suitable for appliances with protection class I acc. to IEC 61140
Terminal	For PCB mounting
Material: Housing	Thermoplastic, black, UL 94V-0

Line Filter	Standard and Medical Version, IEC 60939, UL 1283, CSA C22.2 no. 8 Technical Details
MTBF	> 2'600'000h acc. to MIL-HB-217 F

Approvals and Compliances

Detailed information on product approvals, code requirements, usage instructions and detailed test conditions can be looked up in [Details about Approvals](#)

SCHURTER products are designed for use in industrial environments. They have approvals from independent testing bodies according to national and international standards. Products with specific characteristics and requirements such as required in the automotive sector according to IATF 16949, medical technology according to ISO 13485 or in the aerospace industry can be offered exclusively with customer-specific, individual agreements by SCHURTER.

Approvals







The approval mark is used by the testing authorities to certify compliance with the safety requirements placed on electronic products.

Approval Reference Type: KPF

Approval Logo	Certificates	Certification Body	Description
	VDE Approvals	VDE	VDE Certificate Number: 104869
	UL Approvals	UL	UL File Number: E72928



Product standards

Product standards that are referenced

Organization	Design	Standard	Description
	Designed according to	IEC 60320-1	Appliance couplers for household and similar general purposes
	Designed according to	IEC 60939	Passive filters for suppressing electromagnetic interference
	Designed according to	IEC 61058-1	Switches for appliances. Part 1. General requirements
	Designed according to	UL 498	Standard for Attachment Plugs and Receptacles
	Designed according to	UL 1283	Electromagnetic interference filters
	Designed according to	CSA C22.2 no. 42	General Use Receptacles, Attachment Plugs, and Similar Wiring Devices
	Designed according to	CSA C22.2 no. 8	Electromagnetic interference (EMI) filters





Application standards

Application standards where the product can be used

Organization	Design	Standard	Description
	Designed for applications acc.	IEC/UL 62368-1	IEC 62368-1 includes the basic requirements for safety of audio, video, information technology and office equipment.
	Designed for applications acc.	IEC 60601-1	Medical electrical equipment - Part 1: General requirements for basic safety and essential performance

Compliances

The product complies with following Guide Lines

Identification	Details	Initiator	Description
	CE declaration of conformity	SCHURTER AG	The CE marking declares that the product complies with the applicable requirements laid down in the harmonisation of Community legislation on its affixing in accordance with EU Regulation 765/2008.
	RoHS	SCHURTER AG	Directive RoHS 2011/65/EU, Amendment (EU) 2015/863
	China RoHS	SCHURTER AG	The law SJ / T 11363-2006 (China RoHS) has been in force since 1 March 2007. It is similar to the EU directive RoHS.
	REACH	SCHURTER AG	On 1 June 2007, Regulation (EC) No 1907/2006 on the Registration, Evaluation, Authorization and Restriction of Chemicals 1 (abbreviated as "REACH") entered into force.
	Medical Technology	SCHURTER AG	Suitable for use in medical equipment according to IEC/UL 60601-1

Dimension [mm]

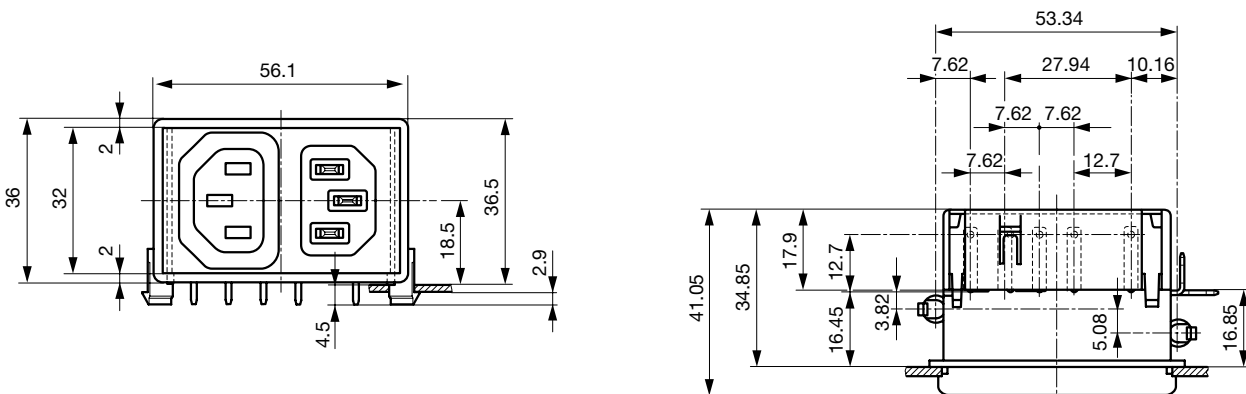

Drilling diagram
 Layout to diagram A

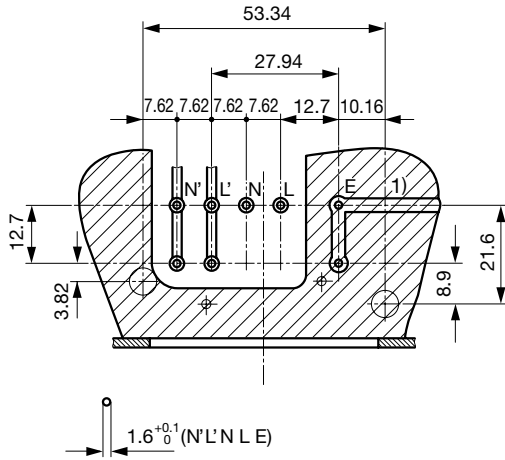

1) Minimum ground plane

Drilling diagram
 Layout to diagram B

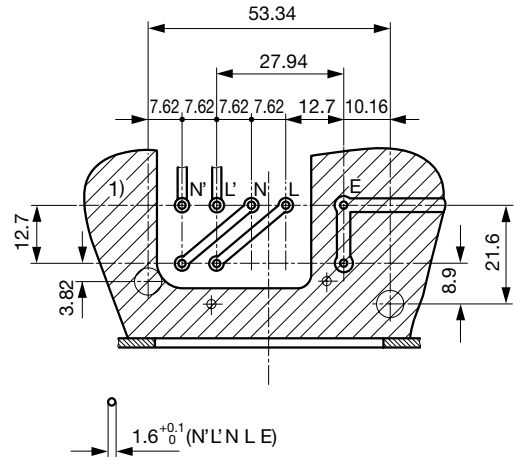

1) Optimal ground plane

Technical Data of Filter-Components

Rated Current [A]	Filter-Type	Inductances L [mH]	Capacitance CX [nF]	Capacitance CY [nF]	R [MΩ]
1	Standard version	2 x 10	100	2.2	-
2	Standard version	2 x 4	100	2.2	-
4	Standard version	2 x 1.6	100	2.2	-
6	Standard version	2 x 1	100	2.2	-
8	Standard version	2 x 0.6	100	2.2	-
10	Standard version	2 x 0.4	100	2.2	-
1	Medical Version (M5)	2 x 10	100	-	1
2	Medical Version (M5)	2 x 4	100	-	1
4	Medical Version (M5)	2 x 1.6	100	-	1
6	Medical Version (M5)	2 x 1	100	-	1
8	Medical Version (M5)	2 x 0.6	100	-	1
10	Medical Version (M5)	2 x 0.4	100	-	1

Diagrams

Standard line filter

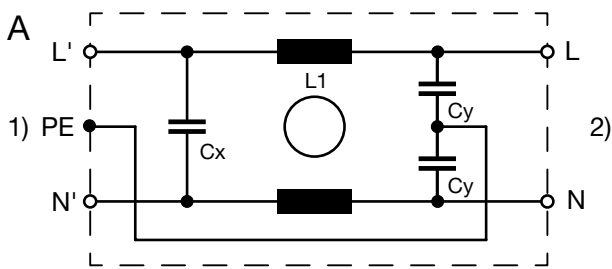

1) Line
 2) Load

EMI filtering of equipment emissions

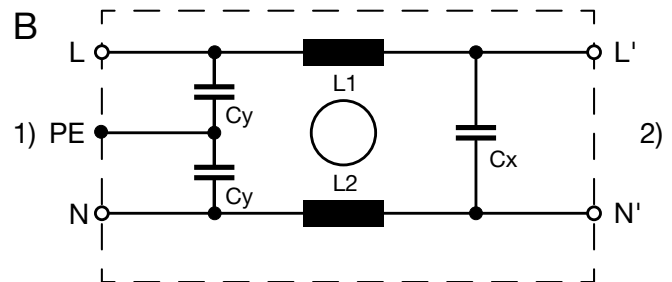

1) Line
 2) Load

Attenuation Loss

--- 50Ω differential mode ____ 50Ω common mode

Standard version

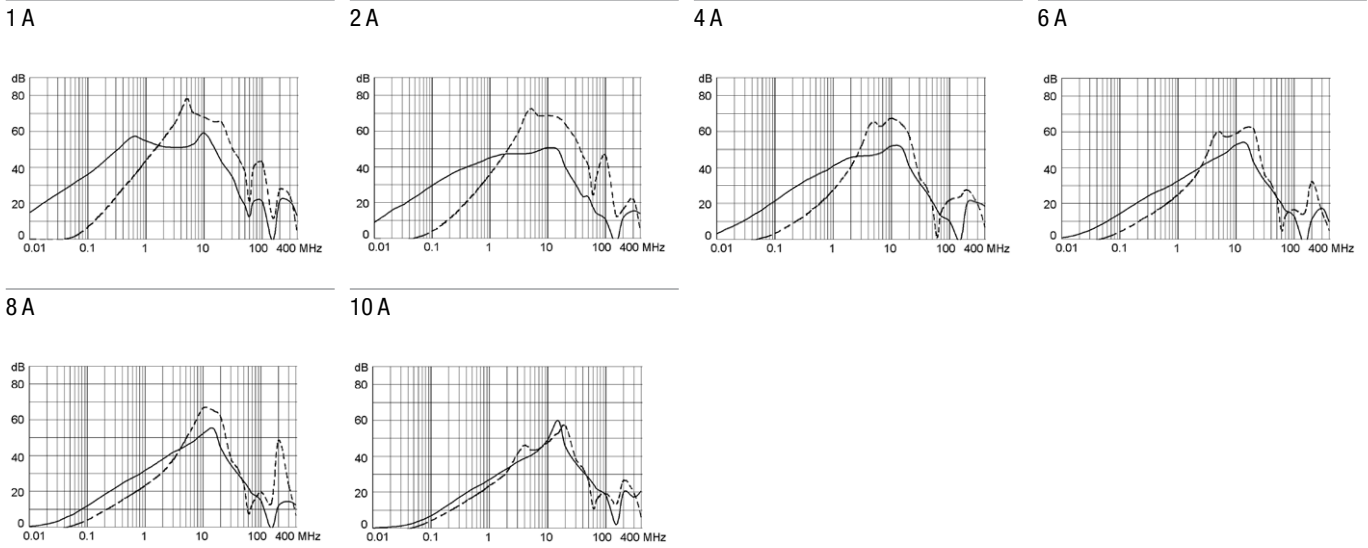

Medical version (M5)

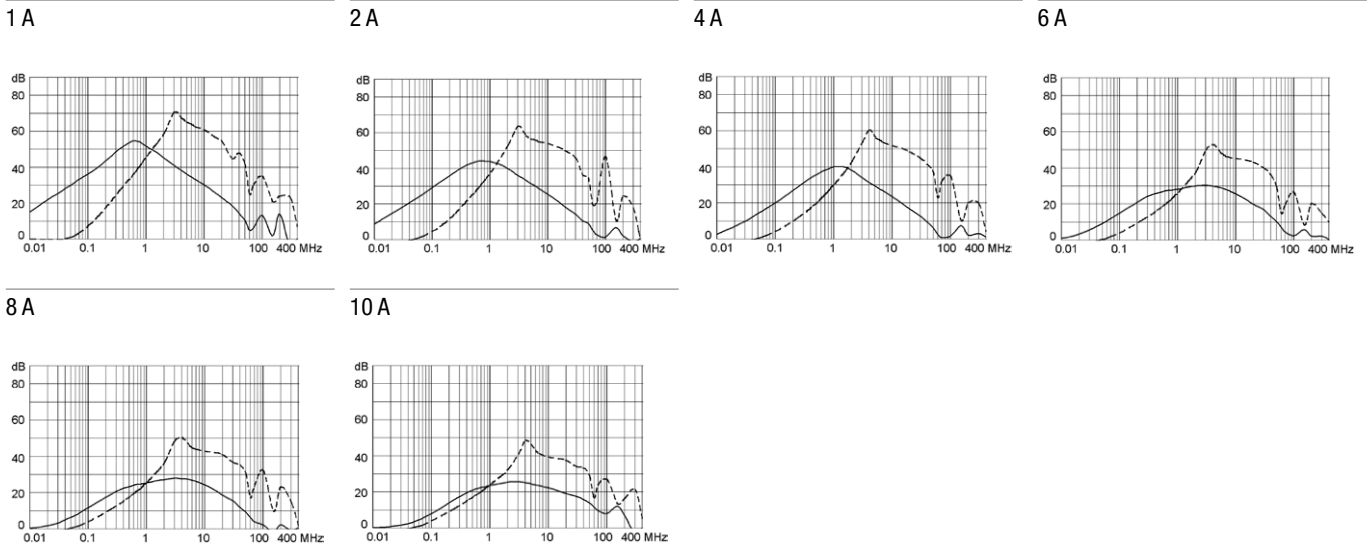

All Variants

Rated Current [A]	Filter-Type	Order Number
1	Standard version	KPF1.1
2	Standard version	KPF2.1
4	Standard version	KPF4.1
6	Standard version	KPF6.1
8	Standard version	KPF8.1
10	Standard version	KPF0.1
1	Medical Version (M5)	KPF1.3
2	Medical Version (M5)	KPF2.3
4	Medical Version (M5)	KPF4.3
6	Medical Version (M5)	KPF6.3
8	Medical Version (M5)	KPF8.3
10	Medical Version (M5)	KPF0.3

Availability for all products can be searched real-time: <https://www.schurter.com/en/Stock-Check/Stock-Check-SCHURTER>

Packaging unit 50 Pcs



Компания «ЭлектроПласт» предлагает заключение долгосрочных отношений при поставках импортных электронных компонентов на взаимовыгодных условиях!

Наши преимущества:

- Оперативные поставки широкого спектра электронных компонентов отечественного и импортного производства напрямую от производителей и с крупнейших мировых складов;
- Поставка более 17-ти миллионов наименований электронных компонентов;
- Поставка сложных, дефицитных, либо снятых с производства позиций;
- Оперативные сроки поставки под заказ (от 5 рабочих дней);
- Экспресс доставка в любую точку России;
- Техническая поддержка проекта, помощь в подборе аналогов, поставка прототипов;
- Система менеджмента качества сертифицирована по Международному стандарту ISO 9001;
- Лицензия ФСБ на осуществление работ с использованием сведений, составляющих государственную тайну;
- Поставка специализированных компонентов (Xilinx, Altera, Analog Devices, Intersil, Interpoint, Microsemi, Aeroflex, Peregrine, Syfer, Eurofarad, Texas Instrument, Miteq, Cobham, E2V, MA-COM, Hittite, Mini-Circuits, General Dynamics и др.);

Помимо этого, одним из направлений компании «ЭлектроПласт» является направление «Источники питания». Мы предлагаем Вам помощь Конструкторского отдела:

- Подбор оптимального решения, техническое обоснование при выборе компонента;
- Подбор аналогов;
- Консультации по применению компонента;
- Поставка образцов и прототипов;
- Техническая поддержка проекта;
- Защита от снятия компонента с производства.



Как с нами связаться

Телефон: 8 (812) 309 58 32 (многоканальный)

Факс: 8 (812) 320-02-42

Электронная почта: org@eplast1.ru

Адрес: 198099, г. Санкт-Петербург, ул. Калинина, дом 2, корпус 4, литера А.