

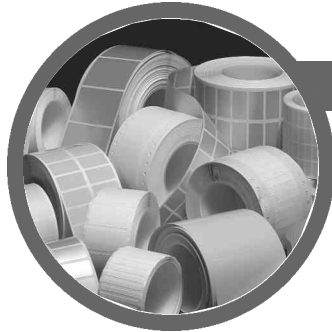

**WIRE AND HARNESS ID PRODUCTS**

2

- Heat Shrink/Cable Markers*
- Performance Labels*
- Self-Laminating Labels*
- Pre-Printed Wire & Cable Markers*



**LABEL ID PRODUCTS**

64

- Product Code Cross Reference*
- Thermal Transfer Labels*
- Dot Matrix Labels*
- Laser Labels*



**HARDWARE/SOFTWARE**

106

- Printers*
- Ribbons*
- Software*
- Application Systems*



**SPECIALTY PRODUCTS**

128

- Pre-Print Services*
- Permark*
- Rail — Signal Products*
- Tube and Pipe ID Labels*

**REFERENCE**

<i>Printer/Material/Ribbon Cross Reference</i>	<b>142</b>
<i>Master Material Specification Chart</i>	<b>144</b>
<i>Industry Icon Key</i>	<b>148</b>
<i>Part Number Index</i>	<b>149</b>



*Electronics*

**HEAT SHRINK/CABLE MARKERS**

TMS-SCE Military Grade Sleeves .....	4	HLX Low Fire Hazard Tags .....	20
CM-SCE Polyolefin Tags .....	6	D-SCE Fluid Resistant Sleeves .....	22
HS 2:1 Shrink Ratio Sleeves .....	8	NMX Flame Retardant Polyaramid Tags .....	24
HL Tie-on Tags .....	10	RPS Commercial Grade Sleeves .....	26
HT-SCE High Temperature Sleeves .....	12	NBC-SCE Nuclear, Biological and Chemical Resistant Sleeves .....	28
HTCM-SCE High Temp Tie-on Tags .....	14	TMS-CCUV UV Resistant Oversleeves ..	30
ZH-SCE Zero Halogen Sleeves .....	16		
HX Low Fire Hazard Sleeves .....	18		



**PERFORMANCE LABELS**

VF/NPVF/VF-130 Polyvinyl Fluoride ..	32
RMK-6 Epoxy Coated Polyester .....	34
RMK Epoxy Coated Polyester .....	36
TTP Polyester .....	38
HPK Polypropylene .....	40
HPC Fabric .....	42



**SELF-LAMINATING LABELS**

SB Thermal Transfer Vinyl .....	44
PVF Thermal Transfer Polyvinyl Fluoride .....	46
TW Dot Matrix Vinyl .....	48
PV Dot Matrix Polyvinyl Fluoride .....	50
LSR Polyester Laser Printable .....	52
Label Dimensions .....	54



**PRE-PRINTED WIRE & CABLE MARKERS**

K-Type Cable Markers .....	56
Z-Type Push On Wire Markers .....	58
Snap On Markers .....	60
CWM Wire Marker Cards .....	62





SHRINK

SHRINK

3:1 SHRINK

3:1 SHRINK

3:1 SHRINK

3:1 SHRINK

3:1 SHRINK

3:1 SHRINK

3:1 SHRINK

3:1 SHRINK

3:1 SHRINK

3:1 SHRINK

3:1 SHRINK

P1  
28

P2  
28

P3  
28

P1  
29

P2  
29

P3  
29

P1  
30

P2  
30

P3  
30

P1  
31

P2  
31

P3  
31

CM-SCE  
CABLE  
MARKER

CM-SCE  
CABLE  
MARKERS

HT-SCE W  
ABC-35  
HARNESS

HT-SCE A  
ABC-351  
HARNESS ASS'Y

HT-SCE WIRE MARKER  
ABC-352 EFG-118  
HARNESS ASSEMBLY

HT-SCE WIRE  
ABC-353  
HARNESS

HT-

**TMS-SCE Military grade heat shrinkable wire identification sleeves**

TMS-SCE marker sleeves are designed to meet the wire and cable marking needs of manufacturers with high performance requirements. Made from durable, flame retarded, radiation-crosslinked heat-shrinkable polyolefin, TMS-SCE marker sleeves can be used in a wide variety of applications. The marker sleeves meet the performance requirements of SAE-AMS- DTL-23053/5 classes 1 and 3 and the TMS-SCE-2X products are made from tubing fully compliant with this specification. The marks are permanent immediately after printing and remain legible even when exposed to abrasion, aggressive cleaning solvents, and military fuels and oils. The sleeves meet the mark permanence requirements of SAE AS8 1531 4.6.2 and MIL-STD-202F both before and after shrinking.

Both 2:1 and 3:1 shrink ratios are available. The 2:1 products provide a thick, rugged sleeve wall and are particularly easy to handle. The lightweight 3:1 products provide extremely fast shrinking and cover a wider range of wire diameters, thus simplifying inventory.

The marker sleeves are designed to be printed by computer-driven dot matrix or thermal transfer printers, providing several advantages in terms of reduced errors, cycle time and cost.

Supplied in a thin, flat "ladder" format, the sleeves are held horizontally between two hole-punched polyester strips. This configuration feeds directly from the storage box into a Tyco-recommended printer. Tyco-recommended ribbons should always be used. The ladder format provides automatic kitting of the marker sleeves in the desired sequence. A standard heat gun with reflector is used to shrink the sleeves onto the wire or cable.

**Features and benefits**

- Permanent identification sleeves.
- Computer-printable.
- Lightweight for aerospace applications.
- Military specification material and print performance.
- 2:1 and 3:1 shrink ratio.
- CSA Certified.
- UL Recognized, VW all flame tubing test rated.
- Quick recovery for heat sensitive areas.



**Temperature rating**

Operating temperature range	-55°C to +135°C	-67°F to +275°F
Minimum recovery temperature	+85°C	+185°F
Maximum storage temperature	+40°C	+104°F

**Specifications/approvals**

Tyco	RT-1805
Military	SAE-AMS-DTL-23053/5 classes 1 and 3, SAE AS8 1531 4.6.2, MIL-STD-202F Method 215J
Industry	UL Recognized – Standard 224, file E35586 CSA Certified – File 31929

**Printer information**

Tyco printer	LQ870 (dot matrix) T208M (thermal transfer, low volume) T312M (thermal transfer)
Tyco ribbon	TMS-SIX-RIBBON-A (dot matrix) TMS-101-RIBBON-4RPSCE (thermal transfer for T208M) TMS-RJS-RIBBON-4RPSCE (thermal transfer for T312M)

**Part numbering system**



**TMS-SCE Military grade heat shrinkable wire identification sleeves (Cont'd)**

**Ordering information**



**Available sizes and formats**

Ordering description	Inside diameter				Recommended use range	Recovered wall thickness		Weight (g/10 pcs.)	
	Expanded D (minimum)		Recovered d (maximum)						
	mm	inches	mm	inches		mm	inches		
TMS-SCE-1K- $\frac{3}{8}$ -2.0- <i>&lt;color&gt;</i>	2.36	<i>0.093</i>	0.79	<i>0.031</i>	0.81 - 1.90	<i>0.032 - 0.075</i>	0.53±0.08	<i>0.021±0.003</i>	1.50
TMS-SCE-2X-1K- $\frac{3}{32}$ - <i>&lt;color&gt;</i>	2.36	<i>0.093</i>	1.17	<i>0.046</i>	1.27 - 1.90	<i>0.050 - 0.075</i>	0.64±0.08	<i>0.025±0.003</i>	2.04
TMS-SCE-1K- $\frac{1}{8}$ -2.0- <i>&lt;color&gt;</i>	3.18	<i>0.125</i>	1.07	<i>0.042</i>	1.11 - 2.66	<i>0.044 - 0.105</i>	0.58±0.08	<i>0.023±0.003</i>	2.03
TMS-SCE-2X-1K- $\frac{1}{8}$ - <i>&lt;color&gt;</i>	3.18	<i>0.125</i>	1.58	<i>0.062</i>	1.75 - 2.66	<i>0.069 - 0.105</i>	0.64±0.08	<i>0.025±0.003</i>	2.75
TMS-SCE-1K- $\frac{3}{16}$ -2.0- <i>&lt;color&gt;</i>	4.75	<i>0.187</i>	1.57	<i>0.062</i>	1.75 - 4.06	<i>0.069 - 0.160</i>	0.58±0.08	<i>0.023±0.003</i>	2.68
TMS-SCE-2X-1K- $\frac{3}{16}$ - <i>&lt;color&gt;</i>	4.75	<i>0.187</i>	2.36	<i>0.093</i>	2.54 - 4.06	<i>0.100 - 0.160</i>	0.64±0.08	<i>0.025±0.003</i>	3.62
TMS-SCE-1K- $\frac{1}{4}$ -2.0- <i>&lt;color&gt;</i>	6.35	<i>0.250</i>	2.11	<i>0.083</i>	2.31 - 5.46	<i>0.091 - 0.215</i>	0.58±0.08	<i>0.023±0.003</i>	3.51
TMS-SCE-2X-1K- $\frac{1}{4}$ - <i>&lt;color&gt;</i>	6.35	<i>0.250</i>	3.18	<i>0.125</i>	3.81 - 5.46	<i>0.150 - 0.215</i>	0.64±0.08	<i>0.025±0.003</i>	5.94
TMS-SCE-1K- $\frac{3}{8}$ -2.0- <i>&lt;color&gt;</i>	9.53	<i>0.375</i>	3.18	<i>0.125</i>	3.47 - 8.12	<i>0.137 - 0.320</i>	0.61±0.08	<i>0.024±0.003</i>	5.04
TMS-SCE-2X-1K- $\frac{3}{8}$ - <i>&lt;color&gt;</i>	9.53	<i>0.375</i>	4.75	<i>0.187</i>	5.59 - 8.12	<i>0.220 - 0.320</i>	0.64±0.08	<i>0.025±0.003</i>	8.50
TMS-SCE-1K- $\frac{1}{2}$ -2.0- <i>&lt;color&gt;</i>	12.70	<i>0.500</i>	4.22	<i>0.166</i>	4.64 - 10.79	<i>0.183 - 0.425</i>	0.61±0.08	<i>0.024±0.003</i>	6.81
TMS-SCE-2X-1K- $\frac{1}{2}$ - <i>&lt;color&gt;</i>	12.70	<i>0.500</i>	6.35	<i>0.250</i>	6.99 - 10.79	<i>0.275 - 0.425</i>	0.64±0.08	<i>0.025±0.003</i>	11.45
TMS-SCE-1K- $\frac{3}{4}$ -2.0- <i>&lt;color&gt;</i>	19.05	<i>0.750</i>	6.35	<i>0.250</i>	6.99 - 16.25	<i>0.275 - 0.640</i>	0.61±0.08	<i>0.024±0.003</i>	12.03
TMS-SCE-2X-1K- $\frac{3}{4}$ - <i>&lt;color&gt;</i>	19.05	<i>0.750</i>	9.53	<i>0.375</i>	10.16 - 16.25	<i>0.400 - 0.640</i>	0.76±0.08	<i>0.030±0.003</i>	20.63
TMS-SCE-1K-1-2.0- <i>&lt;color&gt;</i>	25.40	<i>1.000</i>	8.46	<i>0.333</i>	9.29 - 21.59	<i>0.366 - 0.850</i>	0.64±0.08	<i>0.025±0.003</i>	15.35
TMS-SCE-1K-1 $\frac{1}{2}$ -2.0- <i>&lt;color&gt;</i>	38.10	<i>1.500</i>	19.05	<i>0.750</i>	20.95 - 33.02	<i>0.825 - 1.300</i>	0.51±0.08	<i>0.020±0.003</i>	27.51
TMS-SCE-1K-2-2.0- <i>&lt;color&gt;</i>	50.80	<i>2.000</i>	25.40	<i>1.000</i>	27.94 - 44.95	<i>1.100 - 1.750</i>	0.64±0.08	<i>0.025±0.003</i>	47.27
TMS-SCE-1K-2 $\frac{1}{4}$ -2.0- <i>&lt;color&gt;</i>	57.15	<i>2.250</i>	19.05	<i>0.750</i>	22.32 - 50.80	<i>0.880 - 2.000</i>	0.76±0.08	<i>0.030±0.003</i>	42.06

Total width as supplied 90.18 mm (3.550 inches) including tape and carrier width.

**Options**

Prescoring	Perforated score to produce multiple markers from each sleeve.									
	Number of prescores	1 prescore			2 prescores		3 prescores			
	Code	S1			S2		S3			
Package sizes	Standard		1K - 1000-piece packs							
	Nonstandard		Smaller and larger pack sizes are available. Please contact Tyco.							
	Fanfolded		Fanfolded option available for use with dot matrix printers							
Colors	Standard		Yellow	White						
	Code		4	9						
	Nonstandard		Red	Pink	Orange	Green	Blue	Violet	Gray	Black
	Code		2	2L	3	5	6	7	8	0
Note:		2X products meet the color requirements of MIL-STD-104 class 1; otherwise colors are pastel for print contrast.								

Ordering information: Specify product name, pack size, sleeve size, prescore format, and color.

Ordering example: TMS-SCE-1K- $\frac{1}{8}$ -2.0-S1-9 (scored once)



**Ordering information**



Figure 1  
CM-SCE-1/4 INCH

**Available sizes and formats**

Ordering description	Size	Markable height		Markable length		Recommended use range	
		mm	<i>inches</i>	mm	<i>inches</i>	mm	<i>inches</i>
CM-SCE-1/4-4H- <i>&lt;color&gt;</i>	1/4	6.40	<i>0.250</i>	50.80	<i>2.000</i>	5.08 – 12.50	<i>0.200 – 0.492</i>
CM-SCE-TP-1/4-4H- <i>&lt;color&gt;</i> *	1/4	6.40	<i>0.250</i>	50.80	<i>2.000</i>	5.08 – 12.50	<i>0.200 – 0.492</i>
CM-SCE-1/2-4H- <i>&lt;color&gt;</i>	1/2	12.70	<i>0.500</i>	50.80	<i>2.000</i>	12.50 and up	<i>0.492 and up</i>
CM-SCE-TP-1/2-4H- <i>&lt;color&gt;</i> *	1/2	12.70	<i>0.500</i>	50.80	<i>2.000</i>	12.50 and up	<i>0.492 and up</i>
CM-SCE-1/2-6H- <i>&lt;color&gt;</i>	1/2	12.70	<i>0.500</i>	50.80	<i>2.000</i>	12.50 and up	<i>0.492 and up</i>
CM-SCE-TP-1/2-6H- <i>&lt;color&gt;</i> *	1/2	12.70	<i>0.500</i>	50.80	<i>2.000</i>	12.50 and up	<i>0.492 and up</i>

\* for thermal transfer printing

**Options**

Tie-wrap holes	1/4-inch tags	Four holes standard	
	1/2-inch tags	Four holes	Six holes
	Code	4H	6H
Fanfold	Code	Fx (substitute package size code for "x")	
Package sizes	Standard	250 pieces	
Colors	Standard	White	
	Code	9	
	Nonstandard	Yellow	
	Code	4	

Ordering information: Specify product name, markable height of marker, pack size, number of tie wraps and color.

Ordering example: CM-SCE-2.5K-1/4-4H-9

**HS 2:1 Shrink ratio heat shrinkable wire identification system**

HS sleeves are thin wall, flame retarded radiation cross-linked polyolefin heat-shrinkable tubing, assembled as organized cut sleeves on a paper carrier. HS products are 2:1 shrink ratio. They are used in identification of wires and cables by computer-based printing onto sleeves. These products are suited to a wide variety of applications, including those with military standard requirements. The products meet the material and performance requirements of SAE AMS-DTL-23053/5 class 1.

**Features and benefits**

- Shrink ratio of 2:1 recovers to half of supplied diameter. Contact Tyco for 3:1 option.
- Comes in several sleeve lengths: 38mm, 50mm and 152mm.
- Sleeve diameter from 0.093" to 1.5" (2.4mm to 38.1mm).
- Flame retarded – meets ASTM D 2671 and UL224 (clause 14) standards.
- Single sided and double sided printing formats available.
- Standard dot matrix printable. Contact Tyco for thermal printable options.
- Heat resistance: +175°C (+347°F) for 168 hours or +250°C (+482°F) for 4 hours with no deterioration of properties.
- Concentricity: 70% minimum for low distortion of legends.
- Easy-to-use fan-fold format for improved kitting and marker selection.

**Temperature rating**

Operating temperature range	-55°C to +135°C	-67°F to +275°F
Minimum recovery temperature	+120°C	+248°F
Maximum storage temperature	+40°C	+104°F

**Specifications/approvals**

Tyco	TTDS-033
Military	SAE AMS-DTL-23053/5 Class 1 (material and performance) SAE AS81531 4.6.2 MIL-STD-202F Method 215J
Industry	ASTM D 2671 UL 224 (clause 14)

**Printer information**

Tyco printer	AM6310 (dot matrix)
Tyco ribbon	1892BK03 (dot matrix – high performance) 1892BK04 (dot matrix)

**Part numbering system**

HS	048	YW	1	NF	050	B	
							Pack size
							Sleeve length (mm)
							Format
							Scoring
							Color
							Inside diameter as supplied (mm)
							Product family



**HS 2:1 Shrink ratio heat shrinkable wire identification system (Cont'd)**

**Ordering information**



**Available sizes and formats**

Ordering description	Inside diameter				Recommended use range		Pack size (uncut sleeves)		
	D (min) As supplied		d (max) After recovery				NF(B)	DS(B)	WF(B)
	mm	inches	mm	inches	mm	inches	38 and 50mm lengths	152 mm lengths	
HS024-<color-prescore-format-length-pack size>	2.40	0.093	1.17	0.050	1.27-1.90	0.050-0.075	1650	1100	N/A
HS032-<color-prescore-format-length-pack size>	3.20	0.126	1.58	0.060	1.75-2.66	0.069-0.105	1100	1100	550
HS048-<color-prescore-format-length-pack size>	4.80	0.189	2.36	0.090	2.54-4.06	0.100-0.160	1100	1100	500
HS064-<color-prescore-format-length-pack size>	6.35	0.250	3.18	0.125	3.81-5.46	0.150-0.215	550	550	500
HS095-<color-prescore-format-length-pack size>	9.53	0.374	4.75	0.187	5.59-8.12	0.220-0.320	550	550	275
HS127-<color-prescore-format-length-pack size>	12.70	0.500	6.35	0.250	6.99-10.79	0.275-0.425	550	300	250
HS190-<color-prescore-format-length-pack size>	19.05	0.750	9.53	0.375	10.16-16.25	0.400-0.640	300	300	175
HS254-<color-prescore-format-length-pack size>	25.40	1.000	12.70	0.500	9.29-21.59	0.366-0.850	300	300	125
HS381-<color-prescore-format-length-pack size>	38.10	1.500	19.05	0.750	20.95-22.02	0.825-1.300	100	100	75

**Options**

Prescoring	Perforated score to produce multiple marker sleeves from each HS.					
	Number of prescores	0 prescores	1 prescore	2 prescores	3 prescores	5* prescores
	Markers per sleeve	1	2	3	4	6*
	Code	1	2	3	4	6*
*Wide format only						
Package sizes	B	Standard for narrow format: NF (single sided) and DS (double sided)				
	X	Bulk for narrow format (contains double the number of markers in a narrow format B pack): NF (single sided)				
	B	Standard for wide format: WF (single sided)				
Colors	Standard	White	Yellow			
	Code	WE	YW			
Format	NF	Single-sided printing – narrow format				
	DS	Double-sided printing – narrow format				
	WF	Single-sided printing – wide format				
Uncut sleeve length	038	38 mm (1.5") – narrow format		Ordering example: HS032WE2NF038B		
	050	50 mm (2") – narrow format		Ordering example: HS064YW3NF050X		
	152	152 mm (6") – wide format		Ordering example: HS095WE6WF152B		

Ordering information: Specify product name, color, prescores, format, sleeve length and pack size.

Ordering example: HS032WE2NF038B

**tyco**

Electronics

Heat Shrink/Cable Markers

**HL Tie-on cable marker tags**

Used to identify large cables and bundles either pre- or post-termination, these flame retarded HL cable markers are suitable for use in environments with temperatures of  $-55^{\circ}\text{C}$  to  $+135^{\circ}\text{C}$  ( $-67^{\circ}\text{F}$  to  $+275^{\circ}\text{F}$ ). The markers are easily applied with standard cable ties.

HL markers are presented as organized markers assembled onto either a fanfolded or reeled paper carrier for ease of selection and kitting and are available in an extensive range of sizes.

They are available with the surface designed for either dot matrix or thermal transfer printers.

**Features and benefits**

- Recommended for use where de-termination of wires is not possible for large ID wires or wire bundles.
- Heat resistant to  $+175^{\circ}\text{C}$  for 168 hours or  $+250^{\circ}\text{C}$  for 4 hours with no deterioration in properties.
- Several printable widths and heights available.
- Non-standard color options available.

**Temperature rating**

Operating temperature range	$-55^{\circ}\text{C}$ to $+135^{\circ}\text{C}$	$-65^{\circ}\text{F}$ to $+275^{\circ}\text{F}$
-----------------------------	---	---

**Specifications/approvals**

Tyco	TTDS-037
Military	SAE AS81531 4.6.2 MIL-STD-202F Method 215J
Industry	UL 224 (clause 14) ASTM D 2671

**Printer information**

Tyco printer	AM 6310 (dot matrix) T312M (thermal transfer)
Tyco ribbon	1892BK04 (dot matrix) 1892BK03 (dot matrix – high performance) TMS-RJS-RIBBON-4RPSCE (thermal transfer)

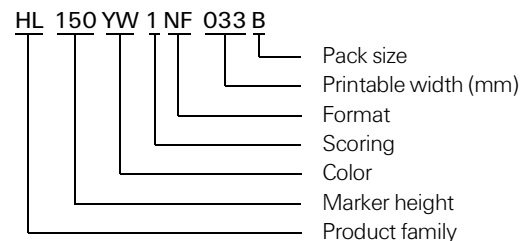
**Part numbering system**

**Ordering information**



**Available sizes and formats**

Ordering description	Marker dimensions (W X H)		Printable area (W X H)		Pack size	
	mm	<i>inches</i>	mm	<i>inches</i>	NF	TS
HL104<color>1<format>025B	45.00 x 10.40	<i>1.800 x 0.400</i>	25.00 x 10.40	<i>1.000 x 0.400</i>	550	1000
HL104<color>1<format>033B	52.00 x 10.40	<i>2.100 x 0.400</i>	33.00 x 10.40	<i>1.300 x 0.400</i>	550	1000
HL104<color>1<format>038B	58.00 x 10.40	<i>2.300 x 0.400</i>	38.00 x 10.40	<i>1.500 x 0.400</i>	550	1000
HL104<color>1<format>050B	70.00 x 10.40	<i>2.750 x 0.400</i>	50.00 x 10.40	<i>2.000 x 0.400</i>	550	1000
HL104<color>1<format>070B	90.00 x 10.40	<i>3.500 x 0.400</i>	70.00 x 10.40	<i>2.750 x 0.400</i>	550	1000
HL150<color>1<format>025B	45.00 x 15.00	<i>1.800 x 0.600</i>	25.00 x 15.00	<i>1.000 x 0.600</i>	550	500
HL150<color>1<format>033B	52.00 x 15.00	<i>2.100 x 0.600</i>	33.00 x 15.00	<i>1.300 x 0.600</i>	550	500
HL150<color>1<format>038B	58.00 x 15.00	<i>2.300 x 0.600</i>	38.00 x 15.00	<i>1.500 x 0.600</i>	550	500
HL150<color>1<format>050B	70.00 x 15.00	<i>2.750 x 0.600</i>	50.00 x 15.00	<i>2.000 x 0.600</i>	550	500
HL150<color>1<format>070B	90.00 x 15.00	<i>3.500 x 0.600</i>	70.00 x 15.00	<i>2.750 x 0.600</i>	550	500
HL203<color>1<format>025B	45.00 x 20.30	<i>1.800 x 0.800</i>	25.00 x 20.30	<i>1.000 x 0.800</i>	550	500
HL203<color>1<format>033B	52.00 x 20.30	<i>2.100 x 0.800</i>	33.00 x 20.30	<i>1.300 x 0.800</i>	550	500
HL203<color>1<format>038B	58.00 x 20.30	<i>2.300 x 0.800</i>	38.00 x 20.30	<i>1.500 x 0.800</i>	550	500
HL203<color>1<format>050B	70.00 x 20.30	<i>2.750 x 0.800</i>	50.00 x 20.30	<i>2.000 x 0.800</i>	550	500
HL203<color>1<format>070B	90.00 x 20.30	<i>3.500 x 0.800</i>	70.00 x 20.30	<i>2.750 x 0.800</i>	550	500
HL253<color>1<format>025B	45.00 x 25.30	<i>1.800 x 1.000</i>	25.00 x 25.30	<i>1.000 x 1.000</i>	300	250
HL253<color>1<format>033B	52.00 x 25.30	<i>2.100 x 1.000</i>	33.00 x 25.30	<i>1.300 x 1.000</i>	300	250
HL253<color>1<format>038B	58.00 x 25.30	<i>2.300 x 1.000</i>	38.00 x 25.30	<i>1.500 x 1.000</i>	300	250
HL253<color>1<format>050B	70.00 x 25.30	<i>2.750 x 1.000</i>	50.00 x 25.30	<i>2.000 x 1.000</i>	300	250
HL253<color>1<format>070B	90.00 x 25.30	<i>3.500 x 1.000</i>	70.00 x 25.30	<i>2.750 x 1.000</i>	300	250

**Options**

Prescoring	Not available on these products – this should always be 1.		
Package sizes	Standard	B	
Colors	Standard	White	Yellow
	Code	WE	YW
Format	Nonstandard	Red	Blue
	Code	RD	BE
Format	NF – Dot matrix printing (fanfold/single sided)		
Format	TS – Thermal transfer (reel/single sided)		
Printable Width On Marker	025	25mm (1")	
	033	33mm (1.3")	
	038	38mm (1.5")	
	050	50mm (2")	
	070	70mm (2.75")	

Ordering information: Specify product name, marker height, color, scoring option (always 1), format, printable width, and pack size.

Ordering example: HL150YW1NF033B

## HT-SCE High temperature, low outgassing heat shrinkable wire identification sleeves

Tyco's HT-SCE wire markers are designed for use in high temperature applications or where extreme resistance to fuels, lubricants and cleaning solvents is required. They are also ideal for applications in which low-vacuum outgassing is critical. The marker sleeves are made of highly flame retarded, heat-shrinkable fluoropolymer tubing.

HT-SCE markers are supplied as a thin, flat "ladder" of sleeves held horizontally between two polyester strips. This configuration feeds directly from the storage box into standard Tyco recommended printers, with no modifications necessary. A strip of adhesive tape on each side of the sleeves holds them securely in place for printing and kitting, yet the sleeves pull easily from the carrier strips. A standard heat gun with reflector is used to shrink the sleeves onto the wire or cable to achieve a permanent mark.

After shrinking, HT-SCE markers meet the print performance requirements of SAE AS81531 4.6.2 and MIL-STD-202F. HT-SCE markers are supplied in boxes of 1000 sleeves and are available in nine diameter sizes. These cover substrates from 0.8 mm to 34.0 mm. Because of this versatility, customers need not carry a large inventory of markers.

### Features and benefits

- Permanent identification sleeves.
- High continuous operating temperature.
- Extreme fluid resistance.
- Low-vacuum outgassing.
- Wide range of sleeve sizes for several wire and bundle diameters.



### Temperature rating

Operating temperature range	-55°C to +225°C	-67°F to +437°F
Minimum recovery temperature	+200°C	+392°F
Maximum storage temperature	+40°C	+104°F

### Specifications/approvals

Tyco	RT1806
Military	SAEAS 81531 4.6.2 MIL-STD-202F Method 215J

### Printer information

Tyco printer	T3 12M (thermal transfer)
Tyco ribbon	TMS-RJS-RIBBON-4HT (thermal transfer)

### Part numbering system

HT-SCE-1K- $\frac{1}{4}$ -2.0-S1-0

Color	0
Scoring (optional)	1
Sleeve length (in)	2.0
Expanded inside diameter (in)	$\frac{1}{4}$
Pack size	1K
Product family	HT-SCE

**Ordering information**



**Available sizes and formats**

Ordering description	Inside diameter				
	D (min) As supplied		d (max) After recovery		Recommended use range
	mm	inches	mm	inches	
HT-SCE-1K- $\frac{2}{3}$ -2.0- <color>	2.36	0.093	0.79	0.031	0.81 - 1.90 0.032 - 0.075
HT-SCE-1K- $\frac{1}{8}$ -2.0- <color>	3.18	0.125	1.58	0.062	1.75 - 2.66 0.069 - 0.105
HT-SCE-1K- $\frac{3}{16}$ -2.0- <color>	4.75	0.187	2.36	0.093	2.54 - 4.06 0.100 - 0.160
HT-SCE-1K- $\frac{1}{4}$ -2.0- <color>	6.35	0.250	3.18	0.125	3.40 - 6.00 0.134 - 0.236
HT-SCE-1K- $\frac{3}{8}$ -2.0- <color>	9.53	0.375	4.75	0.187	5.30 - 8.10 0.209 - 0.319
HT-SCE-1K- $\frac{1}{2}$ -2.0- <color>	12.70	0.500	6.35	0.250	6.60 - 11.40 0.260 - 0.449
HT-SCE-1K- $\frac{3}{4}$ -2.0- <color>	18.00	0.709	9.00	0.354	9.90 - 15.30 0.390 - 0.602
HT-SCE-1K-1-2.0- <color>	25.40	1.000	12.70	0.500	13.30 - 23.00 0.524 - 0.906
HT-SCE-1K-1 $\frac{1}{2}$ -2.0- <color>	38.10	1.500	19.05	0.750	20.95 - 34.00 0.825 - 1.339

Total width as supplied 90.18 mm (3.550 inches) including tape and carrier width.

**Options**

Prescoring	Perforated score to produce multiple marker sleeves from each HT-SCE sleeve			
	Number of prescores	1 prescore	2 prescores	3 prescores
	Code	S1	S2	S3
Package size	Standard	1K - 1000 piece packs		
	Nonstandard	Larger pack sizes are available. Please contact Tyco.		
Colors	Standard	White	Black	
	Code	9	0	
	Nonstandard	Pink	Blue	Yellow
Code	2L	6	4	

Ordering information: Specify product name, pack size, sleeve size, prescore, format and color.

Ordering example: HT-SCE-1K- $\frac{1}{4}$ -2.0-S1-9



Ordering information



Figure 1  
HTCM-SCE-1/4 INCH



Figure 2

Available sizes and formats

Ordering description	Size	Markable height		Markable length		Recommended use range	
		mm	<i>inches</i>	mm	<i>inches</i>	mm	<i>inches</i>
HTCM-SCE-1/4-4H- <i>&lt;color&gt;</i>	1/4	6.40	<i>0.250</i>	50.80	<i>2.000</i>	5.08 – 12.50	<i>0.200 – 0.492</i>
HTCM-SCE-TP-1/4-4H- <i>&lt;color&gt;</i> *	1/4	6.40	<i>0.250</i>	50.80	<i>2.000</i>	5.08 – 12.50	<i>0.200 – 0.492</i>
HTCM-SCE-1/2-4H- <i>&lt;color&gt;</i>	1/2	12.70	<i>0.500</i>	50.80	<i>2.000</i>	12.50 and up	<i>0.492 and up</i>
HTCM-SCE-TP-1/2-4H- <i>&lt;color&gt;</i> *	1/2	12.70	<i>0.500</i>	50.80	<i>2.000</i>	12.50 and up	<i>0.492 and up</i>
HTCM-SCE-1/2-6H- <i>&lt;color&gt;</i>	1/2	12.70	<i>0.500</i>	50.80	<i>2.000</i>	12.50 and up	<i>0.492 and up</i>
HTCM-SCE-TP-1/2-6H- <i>&lt;color&gt;</i> *	1/2	12.70	<i>0.500</i>	50.80	<i>2.000</i>	12.50 and up	<i>0.492 and up</i>

\* for thermal transfer printing

Options

Tie-wrap holes	1/4-inch tags	Four holes standard	
	1/2-inch tags	Four holes	Six holes
	Code	4H	6H
Fanfold	Code	Fx (substitute package size code for "x")	
Package sizes	Standard	250 pieces	
Colors	Standard	White	
	Code	9	
	Nonstandard	Yellow	
	Code	4	

Ordering information: Specify product name, markable height of marker, pack size, number of tie wraps and color.

Ordering example: HTCM-SCE - F2.5K - 1/4-4H-9

**ZH-SCE Zero halogen heat shrinkable wire identification sleeves**

ZH-SCE identification sleeves are for use in enclosed spaces in marine, mass transit, offshore and industrial installations.

ZH-SCE has a 2:1 shrink ratio and is printed using Tyco approved printing equipment and ribbons. The printed mark is permanent immediately after printing and remains legible after exposure to abrasion, aggressive cleaning fluids, military fuels and oils.

Supplied in a thin, flat "ladder" format, the sleeves are held horizontally between two hole-punched polyester strips. This configuration feeds directly from the storage box into a Tyco recommended printer. The ladder format provides automatic kitting of the marker sleeves in the desired sequence.

**Features and benefits**

- Permanent identification sleeves.
- Computer printable.
- Extremely low smoke and acid gas emission.
- 2:1 shrink ratio.
- Standard side scored for easy application.



**Temperature rating**

Operating temperature range	-30°C to +105°C	-22°F to +221°F
Minimum recovery temperature	+120°C	+248°F
Maximum storage temperature	+40°C	+104°F

**Specifications/approvals**

Tyco	RW 2030
Military	SAE AS81531 4.6.2 MIL-STD-202F Method 215J
Industry	BS 6853 [1999] – Vehicle Category 1a

**Printer information**

Tyco printer	T312M (thermal transfer)
Tyco ribbon	TMS-RJS-RIBBON-4ZH (thermal transfer)

**Part numbering system**





**Ordering information**



**Available sizes and formats**

Ordering description	Inside diameter				Recommended use range	
	D (min) as supplied		d (max) after recovery			
	mm	inches	mm	inches	mm	inches
ZH-SCE-1K- $\frac{3}{8}$ -2.0- <color>	2.36	0.093	1.17	0.046	1.27 - 1.90	0.050 - 0.075
ZH-SCE-1K- $\frac{1}{8}$ -2.0- <color>	3.18	0.125	1.57	0.062	1.75 - 2.66	0.069 - 0.105
ZH-SCE-1K- $\frac{3}{16}$ -2.0- <color>	4.75	0.187	2.36	0.093	2.54 - 4.06	0.100 - 0.160
ZH-SCE-1K- $\frac{1}{4}$ -2.0- <color>	6.35	0.250	3.18	0.125	3.40 - 5.50	0.134 - 0.217
ZH-SCE-1K- $\frac{3}{8}$ -2.0- <color>	9.53	0.375	4.75	0.187	5.00 - 9.00	0.197 - 0.354
ZH-SCE-1K- $\frac{1}{2}$ -2.0- <color>	12.70	0.500	6.35	0.250	6.99 - 10.79	0.275 - 0.425
ZH-SCE-1K- $\frac{3}{4}$ -2.0- <color>	19.05	0.750	9.53	0.375	9.90 - 15.30	0.390 - 0.602
ZH-SCE-1K-1-2.0- <color>	25.40	1.000	12.70	0.500	13.30 - 23.00	0.524 - 0.906
ZH-SCE-1K-1- $\frac{1}{2}$ -2.0- <color>	38.10	1.500	19.05	0.750	20.00 - 34.00	0.787 - 1.339

Total width as supplied 90.18 mm (3.550 inches) including tape and carrier width.

**Options**

Prescoring	Perforated score to produce multiple marker sleeves from each ZH-SCE sleeve.			
	Standard	Side scored		
	Number of prescores	1 prescore	2 prescores	3 prescores
Code	S1	S2	S3	
Package sizes	Standard	1K - 1000 piece packages available for all ZH-SCE sizes		
	Nonstandard	Larger pack sizes are available. Please contact Tyco.		
Colors	Standard	White	Yellow	
	Code	9	4	
	Nonstandard	Red	Green	Blue
Code	2	5	6	

Ordering information: Specify product name, pack size, sleeve size, prescore, format and color.

Ordering example: ZH-SCE-1K- $\frac{1}{4}$ -2.0-S1-9

**HX Low fire hazard heat shrinkable wire identification sleeves**

HXwire identification sleeves are used to identify wires and cables where low fire hazard properties are critical. The zero halogen material coupled with low smoke and low toxic fume emissions make this product ideal for use in enclosed spaces such as mass transit, marine and industrial installations. HX markers are suitable for use in environments with temperatures of  $-30^{\circ}\text{C}$  to  $+105^{\circ}\text{C}$  ( $-22^{\circ}\text{F}$  to  $+221^{\circ}\text{F}$ ).

These 2:1 shrink ratio markers are assembled as organized cut sleeves onto a paper carrier for ease of marker selection and kitting. The assembled sleeves are available in both single and double sided printable formats.

**Features and benefits**

- Shrink ratio of 2:1 (recovers to half of supplied diameter).
- Flame retardant – meets ASTM E 162.
- Smoke emission – meets ASTM E 662.
- No secondary mark curing process is required.
- Self-extinguishing.
- Sleeve diameter from 0.125" to 1.50" (3.2 mm to 38.1 mm).
- Sleeve lengths from 0.5" to 2.0" (12.7 mm to 50.8 mm).
- Concentricity: 70% minimum for low distortion of legends.
- Printable on two sides for additional ease in identification.

**Temperature rating**

Operating temperature range	$-30^{\circ}\text{C}$ to $+105^{\circ}\text{C}$	$-22^{\circ}\text{F}$ to $+221^{\circ}\text{F}$
Minimum recovery temperature	$+135^{\circ}\text{C}$	$+275^{\circ}\text{F}$
Maximum storage temperature	$+40^{\circ}\text{C}$	$+104^{\circ}\text{F}$

**Specifications/approvals**

Tyco	RW 2066
Military	SAE AS81531 4.6.2 MIL-STD-202F Method 215J
Industry	BS 6853 [1999] – Vehicle category 1a

**Printer information**

Tyco printer	AM6310 (dot matrix) T312M (thermal transfer)
Tyco ribbon	1892BK03 (dot matrix) 1950-RIBBON-4T300 (thermal transfer)

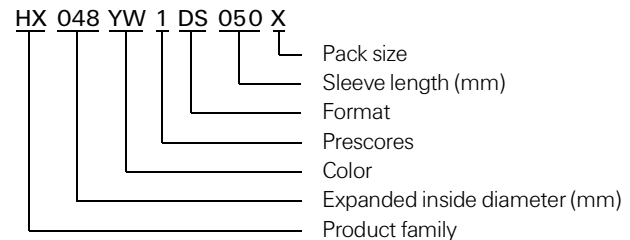
**Part numbering system**

**Ordering information**



**Available sizes and formats**

Ordering description	Inside diameter				Recommended use range		Pack size	
	D (min) As supplied		d (max) After recovery				B pack (uncut sleeves)	
	mm	<i>inches</i>	mm	<i>inches</i>	mm	<i>inches</i>	NF	DS
HX-032-<color-prescore-format-length-pack size>	3.20	<i>0.126</i>	1.58	<i>0.060</i>	1.75-2.66	<i>0.069-0.105</i>	1100	1100
HX-048-<color-prescore-format-length-pack size>	4.80	<i>0.189</i>	2.36	<i>0.090</i>	2.54-4.06	<i>0.100-0.160</i>	1100	1100
HX-064-<color-prescore-format-length-pack size>	6.40	<i>0.250</i>	3.18	<i>0.125</i>	3.81-5.46	<i>0.150-0.215</i>	550	550
HX-095-<color-prescore-format-length-pack size>	9.50	<i>0.374</i>	4.75	<i>0.187</i>	5.59-8.12	<i>0.220-0.320</i>	550	550
HX-127-<color-prescore-format-length-pack size>	12.70	<i>0.500</i>	6.35	<i>0.250</i>	6.99-10.79	<i>0.275-0.425</i>	550	300
HX-190-<color-prescore-format-length-pack size>	19.00	<i>0.750</i>	9.53	<i>0.375</i>	10.16-16.25	<i>0.400-0.640</i>	300	300
HX-254-<color-prescore-format-length-pack size>	25.40	<i>1.000</i>	12.70	<i>0.500</i>	14.29-21.59	<i>0.563-0.850</i>	300	300
HX-381-<color-prescore-format-length-pack size>	38.10	<i>1.500</i>	19.05	<i>0.750</i>	20.95-33.02	<i>0.825-1.300</i>	100	100

**Options**

Prescoring	Perforated score to produce multiple marker sleeves from each HX sleeve.				
	Number of prescores	0 prescores	1 prescore	2 prescores	3 prescores
	Markers per sleeve	1	2	3	4
	Code	1	2	3	4
Package sizes	B	Standard for narrow format (NF and DS)			
	X	Bulk (contains double the number of markers in a B pack)			
Colors	Standard	White	Yellow		
	Code	WE	YW		
	Nonstandard	Red*	Blue*	Green	Orange
		RD	BE	GN	OE
		*Available in DS only			
Format	NF	Single-sided printing (dot matrix only)			
	DS	Double-sided printing (thermal and dot matrix)			
Sleeve length	O38	38 mm			
	O44	44 mm (available in NF only)			
	O50	50 mm			

Ordering information: Specify product name, color, prescores, format, sleeve length and pack size.

Ordering example: HX064YW2DS050X

**HLX Low fire hazard cable marker tags**

HLX cable markers are made from zero halogen, low smoke, low toxicity, radiation cross-linked, UV stabilized polyolefin sheet, formed into punched organized cable markers on a paper carrier.

They are used for identification of cables and wire bundles by computer-based printing onto markers. Markers are attached using cable ties. HLX markers are ideal for applications where limited fire hazard characteristics are critical.

**Features and benefits**

- Recommended for use where combustion of products may endanger personnel or place delicate electronics at risk.
- Several printable heights and widths available.

**Temperature rating**

Operating temperature range    -30°C to +105°C    -22°F to +221°F

**Specifications/approvals**

Tyco	RW 2067
Military	SAE AS81531 4.6.2 MIL-STD-202F Method 215J
Industry	UL 224 (clause 14) BS 4G 198 Part 3 ASTM D 2671

**Printer information**

Tyco printer	T312M (thermal transfer)
Tyco ribbon	1910-RIBBON-4T300 (thermal transfer)

**Part numbering system**

**HLX Low fire hazard cable marker tags (Cont'd)**

**Ordering information**

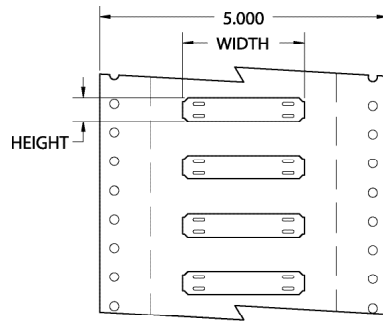

**Available sizes and formats**

Ordering description	Marker dimensions (W X H)		Printable area (W X H)		Pack size	
	mm	inches	mm	inches	NF	TS
HLX104<color>1<format>025B	45.00 x 10.40	<i>1.800 x 0.400</i>	25.00 x 10.40	<i>1.000 x 0.400</i>	550	1000
HLX104<color>1<format>033B	52.00 x 10.40	<i>2.100 x 0.400</i>	33.00 x 10.40	<i>1.300 x 0.400</i>	550	1000
HLX104<color>1<format>038B	58.00 x 10.40	<i>2.300 x 0.400</i>	38.00 x 10.40	<i>1.500 x 0.400</i>	550	1000
HLX104<color>1<format>050B	70.00 x 10.40	<i>2.750 x 0.400</i>	50.00 x 10.40	<i>2.000 x 0.400</i>	550	1000
HLX104<color>1<format>070B	90.00 x 10.40	<i>3.500 x 0.400</i>	70.00 x 10.40	<i>2.750 x 0.400</i>	550	1000
HLX150<color>1<format>025B	45.00 x 15.00	<i>1.800 x 0.600</i>	25.00 x 15.00	<i>1.000 x 0.600</i>	550	500
HLX150<color>1<format>033B	52.00 x 15.00	<i>2.100 x 0.600</i>	33.00 x 15.00	<i>1.300 x 0.600</i>	550	500
HLX150<color>1<format>038B	58.00 x 15.00	<i>2.300 x 0.600</i>	38.00 x 15.00	<i>1.500 x 0.600</i>	550	500
HLX150<color>1<format>050B	70.00 x 15.00	<i>2.750 x 0.600</i>	50.00 x 15.00	<i>2.000 x 0.600</i>	550	500
HLX150<color>1<format>070B	90.00 x 15.00	<i>3.500 x 0.600</i>	70.00 x 15.00	<i>2.750 x 0.600</i>	550	500
HLX203<color>1<format>025B	45.00 x 20.30	<i>1.800 x 0.800</i>	25.00 x 20.30	<i>1.000 x 0.800</i>	550	500
HLX203<color>1<format>033B	52.00 x 20.30	<i>2.100 x 0.800</i>	33.00 x 20.30	<i>1.300 x 0.800</i>	550	500
HLX203<color>1<format>038B	58.00 x 20.30	<i>2.300 x 0.800</i>	38.00 x 20.30	<i>1.500 x 0.800</i>	550	500
HLX203<color>1<format>050B	70.00 x 20.30	<i>2.750 x 0.800</i>	50.00 x 20.30	<i>2.000 x 0.800</i>	550	500
HLX203<color>1<format>070B	90.00 x 20.30	<i>3.500 x 0.800</i>	70.00 x 20.30	<i>2.750 x 0.800</i>	550	500
HLX253<color>1<format>025B	45.00 x 25.30	<i>1.800 x 1.000</i>	25.00 x 25.30	<i>1.000 x 1.000</i>	300	250
HLX253<color>1<format>033B	52.00 x 25.30	<i>2.100 x 1.000</i>	33.00 x 25.30	<i>1.300 x 1.000</i>	300	250
HLX253<color>1<format>038B	58.00 x 25.30	<i>2.300 x 1.000</i>	38.00 x 25.30	<i>1.500 x 1.000</i>	300	250
HLX253<color>1<format>050B	70.00 x 25.30	<i>2.750 x 1.000</i>	50.00 x 25.30	<i>2.000 x 1.000</i>	300	250
HLX253<color>1<format>070B	90.00 x 25.30	<i>3.500 x 1.000</i>	70.00 x 25.30	<i>2.750 x 1.000</i>	300	250

**Options**

Prescoring	Not available on these products – this should always be 1.		
Package sizes	Standard	B	
Colors	Standard	White	Yellow
	Code	WE	YW
Nonstandard	Red	Blue	
	Code	RD	BE
Format	NF – Dot matrix printing (fanfold/single sided)		
	TS – Thermal transfer (reel/single sided)		
Printable width on marker	025	25mm (1")	
	033	33mm (1.3")	
	038	38mm (1.5")	
	050	50mm (2")	
	070	70mm (2.75")	

Ordering information: Specify product name, marker height, color, scoring option (always 1), format, printable width, and pack size.

Ordering example: HLX150YW1NF033B

**D-SCE Fluid resistant computer-printable permanent wire identification sleeves**

D-SCE markers are used to identify wires and cables where exposure to organic fluids, especially oils, is required. D-SCE markers are designed to operate in these conditions at elevated temperatures for extended periods of time, making them ideal in aerospace, rail and construction industries. The D-SCE markers are suitable for use in environments with temperatures of  $-55^{\circ}\text{C}$  to  $+135^{\circ}\text{C}$  ( $-67^{\circ}\text{F}$  to  $+275^{\circ}\text{F}$ ), and will provide strain relief, insulation and protection from mechanical abuse. The 3:1 shrink ratio markers\* are assembled in a ladder format enabling sleeves to be printed on both sides for maximum data content and readability.

\*See ordering description.

**Features and benefits**

- Resistance to organic fluids, common fuels, lubricants and solvents.
- 3:1 shrink ratio.
- Wide range of sizes for several wire and bundle diameters.
- Formulated for use in aerospace, rail and construction equipment.
- Dot matrix and thermal transfer printable — both print technologies meet all specifications and approvals listed.

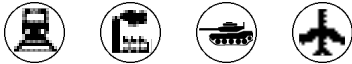

**Temperature rating**

Operating temperature range	$-55^{\circ}\text{C}$ to $+135^{\circ}\text{C}$	$-67^{\circ}\text{F}$ to $+275^{\circ}\text{F}$
Minimum recovery temperature	$+135^{\circ}\text{C}$	$+275^{\circ}\text{F}$
Maximum storage temperature	$+40^{\circ}\text{C}$	$+104^{\circ}\text{F}$

**Specifications/approvals**

Tyco	RW 2028
Military	SAE-AMS-DTL-23053/6, Class 1 (material and performance requirements) SAE AS81531 4.6.2 MIL-STD-202F Method 215J
Industry	NF F 00 608 Category A and H

**Printer information**

Tyco printer	LQ870 (dot matrix) T312M (thermal transfer)
Tyco ribbon	TMS-SIX-RIBBON-A (dot matrix) 1950-RIBBON-4T300 (thermal transfer)

**Part numbering system**

D-SCE - 5K - 3.2 - 50 - S1 - 4

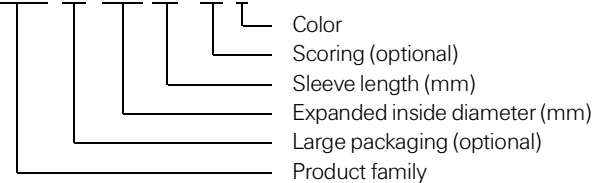

**Ordering information**



**Available sizes and formats**

Ordering description	Inside diameter		Recommended use range			
	D (min)	d (max)				
	As supplied	After recovery				
	mm	inches	mm	inches		
D-SCE-1K-2.4-50<color>	2.39	0.094	0.79	0.031	0.81 - 1.90	0.032 - 0.075
D-SCE-1K-3.2-50<color>	3.18	0.125	1.07	0.043	1.11 - 2.66	0.044 - 0.105
D-SCE-1K-4.8-50<color>	4.75	0.187	1.57	0.063	1.75 - 4.06	0.069 - 0.160
D-SCE-1K-6.4-50<color>	6.35	0.250	2.11	0.084	2.31 - 5.46	0.091 - 0.215
D-SCE-1K-9.5-50<color>	9.53	0.375	3.18	0.125	3.47 - 8.12	0.137 - 0.320
D-SCE-1K-12-50<color>	12.70	0.500	4.22	0.167	4.64 - 10.79	0.183 - 0.425
D-SCE-1K-18-50<color>	19.05	0.750	6.35	0.250	6.99 - 16.25	0.275 - 0.640
D-SCE-1K-25-50<color>	25.40	1.000	8.46	0.333	9.29 - 21.59	0.366 - 0.850
D-SCE-1K-38-50<color>*	38.10	1.500	19.05	0.750	20.95 - 33.02	0.825 - 1.300

\* 2:1 shrink ratio

Total width as supplied 90.18 mm (3.550 inches) including tape and carrier width.

**Options**

Prescoring	Perforated score to produce multiple marker sleeves from each D-SCE sleeve.			
	Standard	Side scored		
	Number of prescores	1 prescore	2 prescores	3 prescores
	Code	S1	S2	S3
Package sizes	Standard	1K - 1000 piece packages available for all D-SCE sizes		
	Nonstandard	Larger pack sizes are available. Please contact Tyco.		
Colors	Standard	White	Yellow	
	Code	9	4	
	Nonstandard	Pink	Blue	
	Code	2L	6	

Ordering information: Specify product name, pack size, sleeve size, prescore, format and color.

Ordering example: D-SCE-1K-6.4-50-S2-4

## NMX Flame retarded polyaramid cable marker tags

NMX cable marker tags are used for identification of cables and wire bundles by computer-based printing onto markers. The markers are attached using cable ties. They are ideal for aerospace and other cases where resistance to harsh environments and light weight are important.

### Features and benefits

- Extremely light weight.
- Ultimate tensile strength and tear resistance.
- Flame retardant.
- Resistant to several avionic fluids, solvents and cleaners.
- Dot matrix printable.
- Available in white and yellow printable areas.

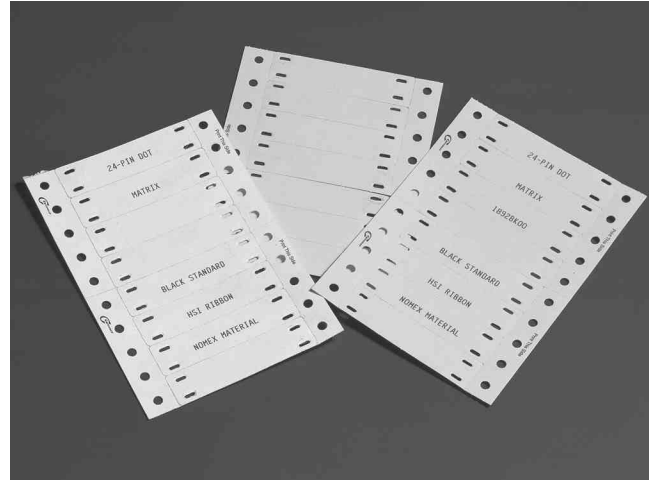

### Temperature rating

Operating temperature range     $-40^{\circ}\text{C}$  to  $+135^{\circ}\text{C}$      $-40^{\circ}\text{F}$  to  $+275^{\circ}\text{F}$

### Specifications/approvals

Military	SAE AS81531 4.6.2, MIL-STD-202F Method 215J
Industry	DMS 2325, DMS 2409

### Printer information

Tyco printer	AM6310 (dot matrix)
Tyco ribbon	1892 BK01 (dot matrix)

### Part numbering system

NMX 25625 WE 2.5

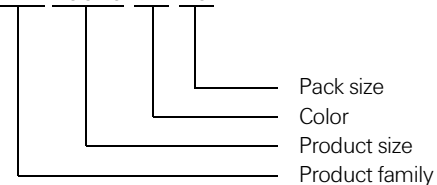



**Ordering information**



**Available sizes and formats**

Ordering description	Label width		Label height		Printable width		Weight (g/10 pcs.)
	mm	<i>inches</i>	mm	<i>inches</i>	mm	<i>inches</i>	
NMX25625<color>2.5	63.50	<i>2.500</i>	15.87	<i>0.625</i>	50.80	<i>2.000</i>	2.5

**Options**

Package sizes	Standard	2500 pieces per pack
	Nonstandard	Larger pack sizes are available. Please contact Tyco.
Colors	White	Yellow
	WE	YE

Ordering information: Specify product name, product size, color and pack size.

Ordering example: NMX25625WE2.5

## RPS Commercial grade wire identification sleeves

RPS markers are heat shrinkable marking sleeves for wire and cable identification. When RPS is printed with Tyco recommended printers and ink ribbons, the marks remain legible, without any post printing process, even when exposed to abrasion, aggressive cleaning solvents, and industrial fluids.

RPS markers are designed to meet the wire identification needs of commercial and industrial customers.

### Features and benefits

- Permanent identification sleeves.
- Computer printable.
- Excellent print performance.
- Configured for ease of kitting.
- Good chemical and solvent resistance.
- 3:1 shrink ratio.
- CSA Certified, UL Recognized.



### Temperature rating

Operating temperature range	-30°C to +105°C	-22°F to +221°F
Minimum recovery temperature	+120°C	+248°F
Maximum storage temperature	+40°C	+104°F

### Specifications/approvals

Tyco	RT 1804
Military	SAE AS81531 4.6.2 MIL-STD-202F Method 2 15J
Industry	UL Recognized – standard 224, file E35586 CSA Certified – file 31929

### Printer information

Tyco printer	LQ870 (dot matrix) T208M (thermal transfer – low volume) T312M (thermal transfer)
Tyco ribbon	TMS-SIX-RIBBON-A (dot matrix) TMS-101-RIBBON-4RPSCE (thermal transfer for T208M) TMS-RJS-RIBBON-4RPSCE (thermal transfer for T312M)

### Part numbering system

RPS-1K-22-18/2.0-S1-9



**Ordering information**



**Available sizes and formats**

Ordering description	Inside diameter				Recommended use range	
	D (min) as supplied		d (max) after recovery			
	mm	<i>inches</i>	mm	<i>inches</i>	mm	<i>inches</i>
RPS-1K-22-18/2.0-<color>	3.18	<i>0.125</i>	1.07	<i>0.042</i>	1.17 - 2.66	<i>0.046 - 0.105</i>
RPS-1K-18-12/2.0-<color>	4.75	<i>0.187</i>	1.57	<i>0.062</i>	1.75 - 4.06	<i>0.069 - 0.160</i>
RPS-1K-16-10/2.0-<color>	6.35	<i>0.250</i>	2.11	<i>0.083</i>	2.31 - 5.46	<i>0.091 - 0.215</i>
RPS-1K-8-4/2.0-<color>	9.53	<i>0.375</i>	3.18	<i>0.125</i>	3.47 - 8.12	<i>0.137 - 0.320</i>
RPS-1K-10-2/2.0-<color>	12.70	<i>0.500</i>	4.22	<i>0.166</i>	4.64 - 10.79	<i>0.183 - 0.425</i>
RPS-1K-6-250/2.0-<color>	19.05	<i>0.750</i>	6.35	<i>0.250</i>	6.99 - 16.25	<i>0.275 - 0.640</i>
RPS-1K-1-400/2.0-<color>	25.40	<i>1.000</i>	8.46	<i>0.333</i>	9.29 - 21.59	<i>0.366 - 0.850</i>
RPS-1K-400-1000/2.0-<color>	38.10	<i>1.500</i>	19.05	<i>0.750</i>	20.95 - 33.02	<i>0.825 - 1.300</i>

Total width as supplied 90.18 mm (3.550 inches) including tape and carrier width.

**Options**

Prescoring	Perforated score to produce multiple marker sleeves from each RPS sleeve.			
	Number of prescores	1 prescore	2 prescores	3 prescores
	Code	S1	S2	S3
Package sizes	Standard	1K - 1000 piece packs		
	Nonstandard	Smaller and larger pack sizes are available. Please contact Tyco.		
Colors	Standard	White	Yellow	
	Code	9	4	

Ordering information: Specify product name, pack size, sleeve size, prescore, format and color.

Ordering example: RPS-1K-22-18/2.0-S2-9

**NBC-SCE Nuclear, biological & chemical heat shrinkable wire identification sleeves**

Tyco NBC-SCE is used to identify wire and cables where extreme resistance to cleaning solvents is needed. The markers are suitable for use in wire harness systems requiring high fluid resistance and resistance to the effects of nuclear, biological and chemical agent exposure and decontamination. The markers should be used with an appropriate transparent oversleeve whose ends are sealed with an appropriate epoxy adhesive.

NBC-SCE marker sleeves are suitable for use in environments with temperatures from  $-55^{\circ}\text{C}$  to  $+225^{\circ}\text{C}$  ( $-67^{\circ}\text{F}$  to  $+275^{\circ}\text{F}$ ).

**Features and benefits**

- Permanent identification sleeves.
- Computer-printable.
- 2:1 shrink ratio.
- NBC application with the appropriate adhesive and oversleeve.

**Temperature rating**

Operating temperature range	$-55^{\circ}\text{C}$ to $+225^{\circ}\text{C}$	$-67^{\circ}\text{F}$ to $+437^{\circ}\text{F}$
Minimum recovery temperature	$+200^{\circ}\text{C}$	$+392^{\circ}\text{F}$
Maximum storage temperature	$+40^{\circ}\text{C}$	$+104^{\circ}\text{F}$

**Specifications/approvals**

Tyco	RT 1809, RT 700
Military	SAE AS81531 4.6.2 MIL-STD-202F Method 215J

**Printer information**

Tyco printer	T3 12M (thermal transfer)
Tyco ribbon	TMS-RJS-RIBBON-4HT (thermal transfer)

**Part numbering system**NBC-SCE-1K- $\frac{1}{4}$ -2.0-S1-9

**Ordering information**



**Available sizes and formats**

Ordering description	Inside diameter				Recommended use range		Recovered wall thickness	
	Expanded D (minimum)		Recovered d (maximum)					
	mm	inches	mm	inches	mm	inches	mm	inches
NBC-SCE-1K-1/8-2.0<color>	3.43	0.135	1.59	0.062	1.75-2.66	0.069-0.105	0.38 ± 0.08	0.015 ± 0.003
NBC-SCE-1K-1/4-2.0<color>	6.35	0.250	3.18	0.125	3.81-5.46	0.150-0.215	0.38 ± 0.08	0.015 ± 0.003
NBC-SCE-1K-1/2-2.0<color>	12.70	0.500	6.35	0.250	6.99-10.79	0.275-0.425	0.38 ± 0.08	0.015 ± 0.003
NBC-SCE-1K-3/4-2.0<color>	19.05	0.750	9.53	0.375	10.16-16.25	0.400-0.640	0.38 ± 0.08	0.015 ± 0.003
NBC-SCE-1K-1-2.0<color>	25.40	1.000	12.70	0.500	14.70-21.50	0.578-0.846	0.43 ± 0.10	0.017 ± 0.004
NBC-SCE-1K-1-1/2-2.0<color>	38.10	1.500	19.05	0.750	20.95-33.02	0.825-1.300	0.43 ± 0.10	0.017 ± 0.004

Total width as supplied 90.18 mm (3.550 inches) including tape and carrier width.

**Options**

Prescoring	Perforated score to produce multiple marker sleeves from each NBC-SCE sleeve.		
	Number of prescores	1 prescore	2 prescores
	Code	S1	S2
			3 prescores
			S3
Package sizes	Standard	1000 piece packages available for all NBC-SCE sizes	
Colors	Standard	White	
	Code	9	

Ordering information: Please specify product name, pack size, sleeve size, prescore, format and color.

Ordering example: NBC-SCE-1K-1/8-2.0-9

## TMS-CCUV Heat shrinkable UV protection sleeves

TMS-CCUV clear heat shrinkable sleeves are designed for over protection of TMS System Six identification products, to give increased protection for permanent, long-term environmental exposure. The clear CCUV heat-shrinkable sleeves are formulated to combine a long-term barrier to the effects of ultra-violet, with tough resistance to abrasion and industrial fluids. They are available in packs which match the product sizes and pack quantities of TMS System Six heat-shrinkable identification sleeves and cable markers.

The TMS CCUV sleeves are inherently low profile and use the action of heat-shrink to lock in place over the previously installed identification sleeves; except for cable markers which use a slide fitting CCUV sleeve which is held in place by the cable ties.

The action of heat-shrink locking of the CCUV sleeves means there is no reliance on the long term performance of adhesives to hold the outer protection layer in place, and also gives the ability to accommodate cables and wire bundles which may be bent or flexed during use.

## Features and benefits

- Exceptional clarity and stability.
- Added UV-resistant sleeves.
- Not printable.
- Tough resistance to abrasion and industrial fluids.
- Heat-shrink locking in place (no reliance on adhesives).
- Low profile.
- Accommodates bent or flexing cable/wire bundles.
- Can work as an NBC (nuclear, biological, chemical) System with NBC-SCE sleeves and appropriate adhesive.



## Ordering information



## Temperature rating

Operating temperature range	-55°C to +150°C	-67°F to 302°F
Minimum recovery temperature	+150°C	+302°F
Maximum storage temperature	+40°C	+104°F

## Specifications/approvals

Tyco	RW 2027
Military	UL VW-1 rated SAE-AMS-DTL-23053/18, Class 2

## Part numbering system

TMS-CCUV-SLEEVE-1-X-65mm

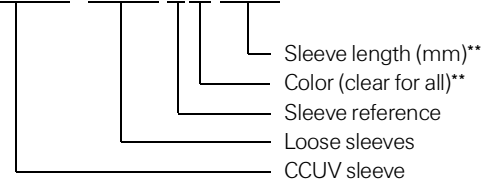

\*\* not used in NBC-SCE 76mm (3") length sleeve options

**Available sizes and formats**

*(For use with heat shrink sleeves)*

Ordering description	Sleeve length		Inside diameter minimum		Recovered diameter maximum		Wire size diameter		Sleeve size expanded diameter	
	mm	inches	mm	inches	mm	inches	mm	inches	TMS-SCE	RPS
TMS-CCUV-SLEEVE-1-X-65mm	65	3.20	0.125	1.60	0.063	1.80-2.80	0.071-0.110	2.40	0.094	N/A
TMS-CCUV-SLEEVE-1-X-65mm	65	3.20	0.125	1.60	0.063	1.80-2.80	0.071-0.110	3.20	0.125	22-18
TMS-CCUV-SLEEVE-2-X-65mm	65	4.80	0.187	2.40	0.094	2.60-3.70	0.102-0.146	4.80	0.188	18-12
TMS-CCUV-SLEEVE-2-X-65mm	65	4.80	0.187	2.40	0.094	2.60-3.70	0.102-0.146	6.40	0.250	16-10
TMS-CCUV-SLEEVE-3-X-65mm	65	6.40	0.250	3.20	0.126	3.50-5.10	0.138-0.201	9.50	0.375	8-4
TMS-CCUV-SLEEVE-4-X-65mm	65	9.50	0.375	4.80	0.189	5.00-7.00	0.197-0.275	12.70	0.500	10-2
TMS-CCUV-SLEEVE-5-X-65mm	65	12.70	0.500	6.40	0.252	6.90-10.60	0.272-0.417	19.00	0.750	6-250
TMS-CCUV-SLEEVE-6-X-65mm	65	19.00	0.750	9.50	0.374	10.00-14.00	0.394-0.551	25.40	1.000	1-400
TMS-CCUV-SLEEVE-7-X-65mm	65	25.40	1.000	12.70	0.500	13.30-21.00	0.524-0.827	25.40	1.000	1-400
TMS-CCUV-SLEEVE-8-X-65mm	65	38.10	1.500	19.00	0.748	21.00-33.80	0.827-1.331	38.10	1.500	400-1000

*Some TMS-SCE and RPS sleeve sizes may need to be recovered partially before CCUV sleeve is applied to protect them.*

*(For use with cable markers to secure / protect without cable ties)*

Ordering description	Sleeve length	Inside diameter minimum		Recovered diameter maximum		Wire size diameter		Marker height	
		mm	inches	mm	inches	mm	inches	mm	inches
TMS-CCUV-SLEEVE-4-X-65mm	65	9.50	0.375	4.80	0.189	5.00-8.00	0.197-0.315	6.40	0.250
TMS-CCUV-SLEEVE-5-X-65mm	65	12.70	0.500	6.40	0.252	7.00-11.00	0.275-0.433	6.40	0.250
TMS-CCUV-SLEEVE-6-X-65mm	65	19.00	0.750	9.50	0.374	12.00-17.00	0.472-0.669	12.70	0.500
TMS-CCUV-SLEEVE-7-X-65mm	65	25.40	1.000	12.70	0.500	15.00-23.00	0.590-0.905	12.70	0.500

*(For use with cable markers to protect with cable ties)*

Ordering description	Sleeve length	Inside diameter minimum		Recovered diameter maximum		Wire size diameter		Marker height	
		mm	inches	mm	inches	mm	inches	mm	inches
TMS-CCUV-SLEEVE-9-X-32mm	32	6.40	0.250	3.20	0.126	N/A		6.40	0.250
TMS-CCUV-SLEEVE-10-X-32mm	32	12.70	0.500	6.40	0.252	N/A		12.70	0.500

*(For use with NBC-SCE sleeves and adhesives sealing\*)*

Ordering description	Sleeve length	Inside diameter minimum		Recovered diameter maximum		Wire size diameter NBC-SCE		Sleeve size expanded diameter NBC-SCE	
		mm	inches	mm	inches	mm	inches	mm	inches
TMS-CCUV-SLEEVE-15	76	3.20	0.125	1.60	0.063	1.80-2.80	0.071-0.110	3.20	0.125
TMS-CCUV-SLEEVE-16	76	4.80	0.187	2.40	0.094	2.60-3.70	0.102-0.146	4.80	0.188
TMS-CCUV-SLEEVE-17	76	6.40	0.250	3.20	0.126	3.50-5.10	0.138-0.201	6.40	0.250
TMS-CCUV-SLEEVE-18	76	9.50	0.375	4.80	0.189	5.00-7.00	0.197-0.275	9.50	0.375
TMS-CCUV-SLEEVE-19	76	12.70	0.500	6.40	0.252	6.90-10.60	0.272-0.417	12.70	0.500
TMS-CCUV-SLEEVE-20	76	19.00	0.750	9.50	0.374	10.00-14.00	0.394-0.551	19.00	0.750
TMS-CCUV-SLEEVE-21	76	25.40	1.000	12.70	0.500	13.30-21.00	0.524-0.827	25.40	1.000
TMS-CCUV-SLEEVE-22	76	38.10	1.500	19.00	0.748	21.00-33.80	0.827-1.331	38.10	1.500

*\*For use with adhesives such as S-1255-04 and S-1264 please refer to RT1012 and RT1014 for specifications and adhesive details.*

**Options**

Prescoring	Not available – supplied as cut pieces.	
Package Sizes	Standard	250 piece bags only
Colors	Standard	Clear only
Ordering information:	Specify product name, loose sleeve, sleeve reference, color and sleeve length.	
Ordering example:	For all Heat Shrink sleeves except NBC-SCE TMS-CCUV-SLEEVE-1-X- 65mm For NBC-SCE TMS-CCUV-SLEEVE-22	

**tyco****Electronics**

Performance Labels

**VF/NPVF/VF-130 Tedlar® color coding tape and labels**

This polyvinyl fluoride material is designed for use as a wire/cable marker, label and wrap-around in the general aviation industry. The product is ideal for a variety of harsh chemical environments and where non-igniting/self-extinguishing properties are a necessity. It is available in several application-defined types and sizes and can be used with various printing technologies.

**VF series**

The VF series of Tedlar® products is specifically designed for wire/cable labeling. The product is dot matrix or thermal transfer printable and is available in several continuous and die-cut formats to fit a wide range of cables/cable bundles. The product meets all the requirements of the BMS 13-47, DMS 2359 and GAT 100BA specifications, the benchmarks for pressure-sensitive wrap-around labels in the aerospace industry.

**NPVF Series**

The NPVF Tedlar® is a non-printable, 12.7mm (½ in) wide and 30.48m (100 ft) long continuous tape designed for use as a color-coded identifier for cables/cable bundles. Besides identifying the bundle this product is wrapped around, it also provides strength and rigidity to the bundle. The product has all the features of the VF series of Tedlar® products except for printability.

**VF-130 Series**

The VF-130 series is a range of clear non-printable Tedlar® tapes designed for use as an over laminate on wires/bundle identifiers where additional UV protection is required. These tapes can be used over various types of identifiers like wrap around labels, heat-shrink labels, tie-on cable labels and pressure-sensitive markers.

**Features and benefits**

- Resists water, oil, conventional cleaning agents, and oil based solvents.
- Filters UV light.
- Exhibits high degree of resistance to aging.
- Meets the requirements of MIL-M-87958.
- Available in several colors to facilitate color-coding and clear for over laminating.

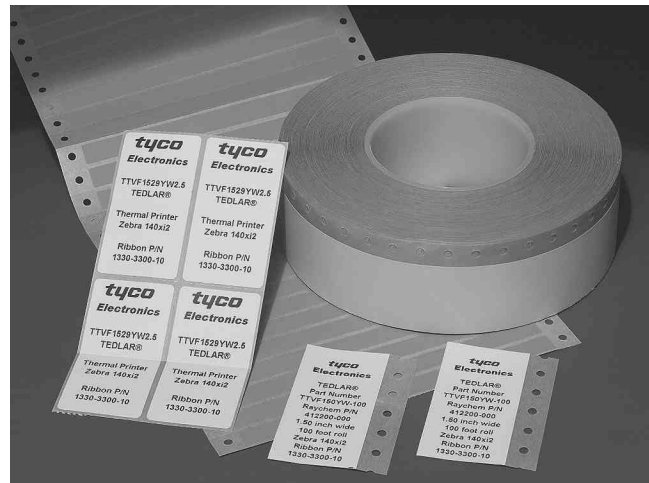
**Temperature rating**

Operating temperature range		
VF and NPVF	-40°C to +130°C	-40°F to +266°F
VF-130	-40°C to +105°C	-40°F to +221°F
VF-130	-40°C to 105°C	-40°F to 221°F

**Specifications/approvals**

Military	MIL-M-87958 DMS 2359
Industry	BMS-13-47 BACT 19 GAT100BA

**Printer information**

Tyco printer	AM6310 (dot matrix) T308S* (thermal transfer) *Size dependent. Contact Tyco.
Tyco ribbon	1892BK01 (dot matrix) 1330-3300-10* (thermal transfer) *Alternative printers and ribbons are available for special applications. Contact Tyco Electronics Identification for more information.

**Part numbering system (Continuous)****Part numbering system (Die-Cut)**



**Ordering information**



**Polyvinyl Fluoride VF Tedlar® – Continuous Labels**

Ordering description	Printer type	Label width mm inches	Label length M FT	Quantity per pack
<format>VF050<color>-180	DM/TT	12.70 0.500	54.86 180	Continuous
<format>VF075<color>-100	DM/TT	19.05 0.750	30.48 100	Continuous
<format>VF100<color>-100	DM/TT	25.40 1.000	30.48 100	Continuous
<format>VF150<color>-100	DM/TT	38.10 1.500	30.48 100	Continuous
<format>VF200<color>-100	DM/TT	50.80 2.000	30.48 100	Continuous
<format>VF300<color>-100	DM/TT	76.20 3.000	30.48 100	Continuous
<format>VF400<color>-100	DM/TT	101.60 4.000	30.48 100	Continuous

**Polyvinyl Fluoride VF Tedlar® – Die-Cut Labels**

Ordering description	Printer type	Label width mm inches	Label height mm inches	Quantity per pack
<format>VF1029<color>2.5	DM/TT	25.40 1.000	73.66 2.900	2500
<format>VF1079<color>1	DM/TT	25.40 1.000	200.66 7.900	1000
<format>VF1529<color>2.5	DM/TT	38.10 1.500	73.66 2.900	2500
<format>VF1679<color>1	DM/TT	40.64 1.600	200.66 7.900	1000
<format>VF3015<color>1	DM/TT	76.20 3.000	38.10 1.500	1000
<format>VF3509<color>2.5	DM/TT	88.90 3.500	22.86 0.900	2500
<format>VF6004<color>2.5	DM/TT	152.40 6.000	10.16 0.400	2500

**Options**

Format	(TT) Thermal transfer printable						
	(DM) Dot matrix printable						
Colors	Yellow	White	Red	Blue	Green	Violet	Pink
Code	YW	WE	RD	BE	GN	VT	PK

**Polyvinyl Fluoride NPVF Tedlar® – Color coding tape**

Ordering description	Printer type	Roll width mm inches	Label length M FT	Quantity per pack
NPVF050XX-100	N/A	12.70 0.500	30.48 100	Continuous

**Options**

Colors	Yellow	White	Red	Blue	Green	Violet	Pink	Black	Brown	Orange	Grey	Gold
Code	YW	WE	RD	BE	GN	VT	PK	BK	BN	OE	GY	GD

**Polyvinyl Fluoride VF-130 Tedlar® – Over laminate tapes**

Ordering description	Printer type	Color	Label width mm inches	Label length M FT	Quantity per pack
NPVF150CL-100	N/A	Clear	38.10 1.500	30.48 100	Continuous
NPVF200CL-100	N/A	Clear	50.80 2.000	30.48 100	Continuous
NPVF300CL-100	N/A	Clear	76.20 3.000	30.48 100	Continuous
NPVF400CL-100	N/A	Clear	101.60 4.000	30.48 100	Continuous

**RMK-6 Computer printable epoxy coated labels**

RMK-6 is a computer printable labelstock with outstanding fluid and abrasion resistance, designed to be printed by impact dot matrix printers. When heat-cured after printing, its unique heat reactive epoxy surface "locks in" the image to combine the versatility and convenience of on-site printing with performance to meet the toughest conditions. A high performance acrylic adhesive ensures simple installation while maintaining excellent adhesion.

Typical applications are rating plate labels, component identification, and pipe and cable wraparound markers. Outdoor use is not recommended.

**Features and benefits**

- Printable by dot matrix printers.
- Excellent fluid and abrasion resistance without an overlay.
- High performance acrylic adhesive.
- Low fire hazard properties.
- Indoor use only.

**Temperature rating**

## Operating temperature range

Wiring marking	-40°C to +85°C	-40°F to +185°F
Panel marking	-40°C to +105°C	-40°F to +221°F

## Excursion temperature

+200°C for 2 hours

## Storage conditions

Unopened	12 months at temperatures not exceeding +35°C (+95°F).
Opened	6 months at temperatures not exceeding +25°C (+77°F) and 80% relative humidity

## Curing

4 - 6 minutes at 160°C in an air circulating oven.

**Specifications/approvals**

Tyco		RK 6648
Industry	UL	MH17259 Group PGGU2

**Printer information**

Tyco printer	AM6310 (dot matrix)
Tyco ribbon	1892BK04 (dot matrix)

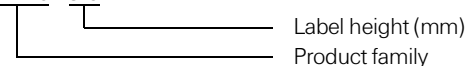
**Part numbering system****RMK6 - 8.5**

**RMK-6 Computer printable epoxy coated labels (Cont'd)**

**Ordering information**



**Available sizes and formats**

Ordering description	Label height mm	Label width mm	Package quantity Labels per pack
RMK6-4.2	4.20	50.80	10000
RMK6-8.5	8.50	50.80	5000
RMK6-12.7	12.70	50.80	3000
RMK6-17.0	17.00	50.80	2500
RMK6-25.4	25.40	50.80	1500
RMK6-55.0	55.00	50.80	750
RMK6-WM*	*	50.80	*

\*An uncut version for wraparound markers. Spool length = 40 meters.

**Options**

Colors	Standard	White
--------	----------	-------

**tyco****Electronics**

Performance Labels

**RMK Computer printable epoxy coated labels in a sheet form**

RMK is a computer printable labelstock with outstanding fluid and abrasion resistance, designed to be printed by sheet fed inkjet printers. When heat-cured after printing its unique heat reactive epoxy surface "locks in" the image to combine the versatility and convenience of on-site printing with performance to meet the toughest conditions. A high performance acrylic adhesive ensures simple installation while maintaining excellent adhesion. A wide range of label sizes are available, supplied in A4 sheets for feeding through standard inkjet printers.

Typical applications are replacement of engraved metal or plastic labels, signs and tallies rating plate labels and color coding.

**Features and benefits**

- High performance label material.
- High performance acrylic adhesive.
- A4 format sheet.
- Printable by color inkjet printers with sheet feed.
- Outstanding fluid and abrasion resistance without an overlay.
- Low fire hazard properties.
- Indoor use only.

**Temperature rating**

Operating temperature range

Wiring marking	-40°C to +85°C	-40°F to +185°F
Panel marking	-40°C to +105°C	-40°F to +221°F

Excursion temperature

+200°C for 2 hours

Storage conditions

Unopened  
12 months at temperatures not exceeding +35°C (+95°F)Opened  
6 months at temperatures not exceeding +25°C (+77°F)  
and 80% relative humidity

Curing

4-6 minutes at 160°C  
in an air circulating oven.**Specifications/approvals**

Tyco	RK 6648
------	---------

**Printer information**

Various color inkjet printers can be used depending on the application.

Tyco recommended printer HP-900 Series

For further advice on possible alternative printers, contact Tyco.

**Part numbering system**

RMK-18x35-A4



**Ordering information**



A4 sheet dimensions



Label dimensions

**Available sizes and formats**

Ordering description	Label height mm	Label width mm	Labels per sheet
RMK-9x25-A4	9	25	132
RMK-10x19-A4	10	19	160
RMK-11x40-A4	11	40	72
RMK-18x20-A4	18	20	96
RMK-18x25-A4	18	25	72
RMK-18x35-A4	18	35	48
RMK-18x50-A4	18	50	36
RMK-25x30-A4	25	30	45
RMK-25x35-A4	25	35	36
RMK-25x50-A4	25	50	27
RMK-25x75-A4	25	75	18
RMK-25x100-A4	25	100	10
RMK-28x40-A4	28	40	32
RMK-30x13-A4	30	13	88
RMK-35x75-A4	35	75	12
RMK-50x13-A4	50	13	50
RMK-50x25-A4	50	25	30
RMK-50x100-A4	50	100	5
RMK-75x150-A4	75	150	3
RMK-87x13-A4	87	13	33
RMK-87x25-A4	87	25	18
RMK-150x150-A4	150	150	1
RMK-170x13-A4	170	13	11
RMK-170x25-A4	170	25	6
RMK-190x30-A4	190	30	5
RMK-200x13-A4	200	13	10
RMK-250x13-A4	250	13	11
RMK-250x25-A4	250	25	6
RMK-UNCUT-A4	Uncut		50 sheets

**Options**

Package size	Standard	50 sheets
Color	Standard	White

## TTP Continuous polyester for decals

The system is designed for applications that require a high-durability label with all the features of a "silk-screened" label, only without the cost, time and inflexibility involved in obtaining a silk-screened product. The product utilizes high performance polyester with permanent acrylic adhesive. It is thermal transfer printable with all the capabilities of graphics, barcodes, logos and several fonts. The product is available in several colors although white, clear and metalized silver are available as standard. Typical applications include panel labels, fascias, decalcomanias and asset identification and rating plates. Typical industry use includes aerospace, defense, electronics and infrastructure.

## Features and benefits

- Efficient solution for expensive silk-screen printing.
- Available in continuous format.
- Several widths and colors available.
- Interior and exterior aircraft use including flight entertainment and deck instrumentation.
- Thermal transfer printable.
- Printable in any combination of material and ribbon colors.



## Temperature rating

Operating temperature range

Clear	-40°C to +125°C	-40°F to +257°F
White, metalized and colors	-29°C to +150°C	-20°F to +302°F

## Specifications/approvals

Military	MIL-P-38477A (Salt spray) A-A-59485 (accelerated weather resistance and salt spray)
Industry	GAT 100BB

## Printer information

Tyco printer	T312S (thermal transfer)
Tyco ribbon	1330-3300-10 (thermal transfer)

## Part numbering system

TTP 200 CL-10



**Ordering information**



**Available sizes and formats**

Ordering description	Label width		Roll length		Quantity per pack
	mm	<i>inches</i>	meters	<i>feet</i>	
TTP200<color>-10	50.80	<i>2.000</i>	30.48	<i>100</i>	Continuous
TTP300<color>-10	76.20	<i>3.000</i>	30.48	<i>100</i>	Continuous
TTP400<color>-10	101.60	<i>4.000</i>	30.48	<i>100</i>	Continuous
TTP600<color>-10	152.40	<i>6.000</i>	30.48	<i>100</i>	Continuous

**Options**

Colors	Standard	Clear	White	Metalized silver			
	Code	CL	WE	MP			
	Non Standard	Red	Green	Blue	Orange	Black	Yellow
	Code	RD	GN	BE	OE	BK	YW

Ordering example: TTP300GN-10



Electronics

Performance Labels

HPK Thermal transfer printable panel labels

Tyco HPK is a semi-rigid, heavy gauge polypropylene film with a permanent acrylic adhesive, designed to permanently identify control panel components and racks, as well as general labeling applications that require a high performance heavy gauge material. They offer excellent abrasion resistance, and adhere to most smooth surfaces including bare and painted metal.

For guaranteed print performance and durability, use with Tyco's RHD series ribbon.

Features and benefits

- Self-adhesive backing for quick and easy fixing.
- Thermal transfer printable.
- Recommended for indoor use.
- Resistant to common fluids, lubricants and solvents.



Temperature rating

Operating temperature range	-29°C to +80°C	-24°F to +176°F
Minimum recovery temperature	10°C	+50°F

Printer information

Tyco printer	T308S (thermal transfer)
Tyco ribbon	1330-0607-10 (thermal transfer)

Part numbering system

HPK 02 WE 1 050





**HPK Thermal transfer printable panel labels (Cont'd)**

**Ordering information**



**Available sizes and formats**

Ordering description	Labels across	(A) Label width		(B) Label height		(C) Vertical repeat		(D) Web width	
		mm	<i>inches</i>	mm	<i>inches</i>	mm	<i>inches</i>	mm	<i>inches</i>
HPK02WE1050	1	50.80	<i>2.000</i>	5.10	<i>0.200</i>	8.30	<i>0.325</i>	57.20	<i>2.250</i>
HPK04WE1050	1	50.80	<i>2.000</i>	10.20	<i>0.400</i>	13.30	<i>0.525</i>	57.20	<i>2.250</i>
HPK06WE1050	1	50.80	<i>2.000</i>	15.20	<i>0.600</i>	18.40	<i>0.725</i>	57.20	<i>2.250</i>
HPK08WE1050	1	50.80	<i>2.000</i>	20.30	<i>0.800</i>	23.50	<i>0.925</i>	57.20	<i>2.250</i>
HPK10WE1050	1	50.80	<i>2.000</i>	25.40	<i>1.000</i>	28.60	<i>1.125</i>	57.20	<i>2.250</i>

**Options**

Prescoring	Perforated score to produce multiple labels from each HPK label.		
Number of prescores	0 prescores	1 prescore	
Code	1	2	
Package size	Standard	1000 piece pack	
Color	Standard	White	

Ordering information: Specify product name, product size and prescores.

Ordering example: HPK02WE1050

**tyco****Electronics**

Performance Labels

**HPC Dot matrix printable panel labels**

Tyco HPC is a semi-rigid, heavy gauge specially formulated fabric material with a high tack permanent acrylic adhesive that is designed to permanently identify control panel components and racks, as well as general labeling applications that require a high performance, heavy gauge material. It has excellent abrasion resistance and adheres to most smooth surfaces including bare and painted metal.

For guaranteed print performance and durability, use with Tyco's RI Quick Dry series ribbon.

**Features and benefits**

- Specially formulated fabric material.
- Dot matrix printable.
- Print performance exceeds military specs.
- High performance acrylic adhesive.
- Single score option available.

**Temperature rating**

Operating temperature range      -54°C to +71°C      -65°F to +160°F

**Specifications/approvals**

Military      SAE AS8153 1 4.6.2  
MIL-STD-202F method 215J

**Printer information**

Tyco printer      AM63 10\* (dot matrix)  
Tyco ribbon      1892BK01\* (dot matrix)

*\*Alternate printers and ribbons available for special applications. Contact Tyco Electronics Identification for more information.*

**Part numbering system**

**HPC 02 WE 1 050**



**HPC Dot matrix printable panel labels (Cont'd)**

Ordering information



Available sizes and formats

Ordering description	Number of labels across	(A) Label width		(B) Label height		(C) Vertical repeat		(D) Web width	
		mm	<i>inches</i>	mm	<i>inches</i>	mm	<i>inches</i>	mm	<i>inches</i>
HPC02WE1050	1	50.80	<i>2.000</i>	5.10	<i>0.200</i>	5.10	<i>0.200</i>	76.20	<i>3.000</i>
HPC04WE1050	1	50.80	<i>2.000</i>	10.20	<i>0.400</i>	10.20	<i>0.400</i>	76.20	<i>3.000</i>
HPC06WE1050	1	50.80	<i>2.000</i>	15.20	<i>0.600</i>	15.20	<i>0.600</i>	76.20	<i>3.000</i>
HPC08WE1050	1	50.80	<i>2.000</i>	20.30	<i>0.800</i>	20.30	<i>0.800</i>	76.20	<i>3.000</i>
HPC10WE1050	1	50.80	<i>2.000</i>	25.40	<i>1.000</i>	25.40	<i>1.000</i>	76.20	<i>3.000</i>

Options

Prescoring	Perforated score to produce multiple labels from each HPC label.			
Standard	Number of prescores	0 prescores	1 prescore	
	Labels per 2" width	1	2	
	Code	1	2	
Package sizes	Standard	1000 piece packages available.		
Colors	Standard	White		

Ordering information: Specify product name, size, color, prescore and length.

Ordering example: HPC02WE1050

**tyco****Electronics**

Self-Laminating Labels

**SB Thermal transfer printable self-laminating labels**

Tyco SB is a thermal transfer printable, translucent vinyl film with a permanent acrylic adhesive, supplied with a white printable area, which is over-laminated upon application with the translucent portion of the label. This 'self-laminating' feature protects the printed area from exposure to oil, solvents, water and abrasion. SB labels offer excellent conformability to round, irregular or flexible surfaces. Ideal for wire and cable identification, including flat ribbon cables that are subject to repeated bending, they are UL and CSA Listed. For guaranteed print performance and durability, use with Tyco's 3300 series ribbon.

**Features and benefits**

- Manufactured with a white coated area for printing or writing on, and with a clear wrap to wind around a wire or cable over the printed surface to seal out impurities that would cause the label to become illegible.
- Protects printed information from chemicals and frequent handling.
- Designed to withstand exposure to oil, solvents, and water.
- Can also be flagged around a wire rather than wrapped.

**Temperature rating**

Operating temperature range	-54°C to +82°C	-65°F to +180°F
-----------------------------	----------------	-----------------

**Printer information**

Tyco printer	T308S* (thermal transfer)
Tyco ribbon	1330-3300-10* (thermal transfer)

*\* Alternative printers and ribbons are available for special applications. Contact Tyco Electronics Identification for more information.*

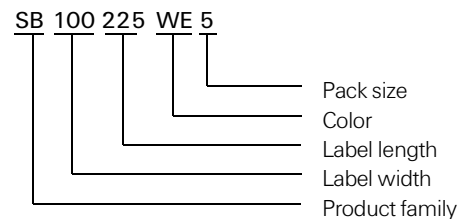
**Part numbering system**

**SB Thermal transfer printable self-laminating labels (Cont'd)**

**Ordering information**



**Available sizes and formats**

Ordering description	Package quantity	Labels across	(A) Label width		(B) Label height		(C) Printable height		(D) Horizontal repeat		(E) Vertical repeat		(F) Web width	
			mm	<i>inches</i>	mm	<i>inches</i>	mm	<i>inches</i>	mm	<i>inches</i>	mm	<i>inches</i>	mm	<i>inches</i>
SB050100WE10	10,000	5	12.70	<i>0.500</i>	25.40	<i>1.000</i>	8.50	<i>0.330</i>	16.80	<i>0.600</i>	31.00	<i>1.222</i>	86.00	<i>3.384</i>
SB050143WE10	10,000	5	12.70	<i>0.500</i>	36.50	<i>1.437</i>	12.70	<i>0.500</i>	16.80	<i>0.662</i>	42.20	<i>1.661</i>	86.00	<i>3.384</i>
SB075094WE10	10,000	4	19.10	<i>0.750</i>	36.50	<i>0.940</i>	9.50	<i>0.375</i>	20.30	<i>0.800</i>	28.60	<i>1.125</i>	85.10	<i>3.350</i>
SB080150WE10	10,000	4	20.30	<i>0.800</i>	38.10	<i>1.500</i>	12.70	<i>0.500</i>	22.90	<i>0.900</i>	44.50	<i>1.750</i>	94.90	<i>3.736</i>
SB100143WE5	5,000	3	25.40	<i>1.000</i>	36.50	<i>1.437</i>	12.70	<i>0.500</i>	27.90	<i>1.100</i>	42.20	<i>1.661</i>	87.30	<i>3.436</i>
SB100225WE5	5,000	3	25.40	<i>1.000</i>	57.20	<i>2.250</i>	19.10	<i>0.750</i>	27.90	<i>1.100</i>	66.70	<i>2.625</i>	87.30	<i>3.436</i>
SB100375WE2.5	2,500	3	25.40	<i>1.000</i>	95.30	<i>3.750</i>	25.40	<i>1.000</i>	27.90	<i>1.100</i>	101.60	<i>4.000</i>	87.30	<i>3.436</i>
SBH100375WE2.5	2,500	1*	25.40	<i>1.000</i>	95.30	<i>3.750</i>	25.40	<i>1.000</i>	N/A	N/A	28.60	<i>1.125</i>	100.30	<i>3.950</i>
SB100594WE1	1,000	3	25.40	<i>1.000</i>	151.00	<i>5.940</i>	38.10	<i>1.500</i>	27.90	<i>1.100</i>	158.80	<i>6.250</i>	87.30	<i>3.436</i>
SB100743WE1	1,000	3	25.40	<i>1.000</i>	188.90	<i>7.437</i>	38.10	<i>1.500</i>	27.90	<i>1.100</i>	195.30	<i>7.688</i>	87.30	<i>3.436</i>
SB190319WE2.5	2,500	2	48.30	<i>1.900</i>	81.00	<i>3.190</i>	19.10	<i>0.750</i>	50.80	<i>2.000</i>	87.40	<i>3.440</i>	105.10	<i>4.138</i>
SB190594WE1	1,000	2	48.30	<i>1.900</i>	151.00	<i>5.940</i>	38.10	<i>1.500</i>	50.80	<i>2.000</i>	158.80	<i>6.250</i>	105.10	<i>4.138</i>
SB200143WE2.5	2,500	2	50.80	<i>2.000</i>	36.50	<i>1.437</i>	12.70	<i>0.500</i>	50.80	<i>2.000</i>	42.20	<i>1.661</i>	107.60	<i>4.236</i>
SB200225WE2.5	2,500	2	50.80	<i>2.000</i>	57.20	<i>2.250</i>	19.10	<i>0.750</i>	50.80	<i>2.000</i>	66.70	<i>2.625</i>	107.60	<i>4.236</i>
SB200375WE2.5	2,500	2	50.80	<i>2.000</i>	95.30	<i>3.750</i>	25.40	<i>1.000</i>	53.30	<i>2.100</i>	101.60	<i>4.000</i>	111.40	<i>4.386</i>
SB200743WE1	1,000	2	50.80	<i>2.000</i>	188.90	<i>7.437</i>	38.10	<i>1.500</i>	53.30	<i>2.100</i>	195.30	<i>7.688</i>	110.10	<i>4.336</i>

\*One label across rotated format.

**Options**

Colors	Standard	White with clear tail
--------	----------	-----------------------

**tyco****Electronics**

Self-Laminating Labels

**PVF Polyvinylfluoride thermal transfer printable self-laminating labels**

Tyco PVF is a thermal transfer printable, translucent polyvinyl fluoride (Tedlar®) film with a permanent acrylic adhesive, designed for wire and cable marking applications that require the 'self-extinguishing' properties of Tedlar®. PVF labels are supplied with a white printable area, which is over-laminated upon application with the translucent portion of the label. This 'self-laminating' feature protects the printed area from exposure to oil, solvents, water and abrasion. The low-profile design makes PVF suitable for wrapping onto thin wire gauges. For guaranteed print performance and durability use with Tyco's 3300 series ribbon.

**Features and benefits**

- Resists water, oils, and conventional cleaning agents.
- Filters UV light.
- Exhibits high degree of resistance to aging.
- Thermal transfer printable.

**Temperature rating**

Operating temperature range    -40°C to +105°C    -40°F to +221°F

**Printer information**

Tyco printer    T308S\* (thermal transfer)  
Tyco ribbon    1330-3300-10\* (thermal transfer)

*\*Alternative printers and ribbons are available for special applications. Contact Tyco Electronics Identification for more information.*

**Part numbering system**

PVF 080 150 WE 10



Ordering information



Available sizes and formats

Ordering description	Package quantity	Labels across	(A) Label width		(B) Label height		(C) Printable height		(D) Horizontal repeat		(E) Vertical repeat		(F) Web width	
			mm	inches	mm	inches	mm	inches	mm	inches	mm	inches	mm	inches
PVF050100WE10	10,000	5	12.70	<i>0.500</i>	25.40	<i>1.000</i>	8.50	<i>0.330</i>	16.80	<i>0.600</i>	31.00	<i>1.222</i>	86.00	<i>3.384</i>
PVF050143WE10	10,000	5	12.70	<i>0.500</i>	36.50	<i>1.437</i>	12.70	<i>0.500</i>	16.80	<i>0.662</i>	42.20	<i>1.661</i>	86.00	<i>3.384</i>
PVF080150WE10	10,000	4	20.30	<i>0.800</i>	38.10	<i>1.500</i>	12.70	<i>0.500</i>	22.90	<i>0.900</i>	44.50	<i>1.750</i>	94.90	<i>3.736</i>
PVF100143WE5	5,000	3	25.40	<i>1.000</i>	36.50	<i>1.437</i>	12.70	<i>0.500</i>	27.90	<i>1.100</i>	42.20	<i>1.661</i>	87.30	<i>3.436</i>
PVF100225WE5	5,000	3	25.40	<i>1.000</i>	57.20	<i>2.250</i>	19.10	<i>0.750</i>	27.90	<i>1.100</i>	66.70	<i>2.625</i>	87.30	<i>3.436</i>
PVF100375WE2.5	2,500	3	25.40	<i>1.000</i>	95.30	<i>3.750</i>	25.40	<i>1.000</i>	27.90	<i>1.100</i>	101.60	<i>4.000</i>	87.30	<i>3.436</i>
PVF100594WE1	1,000	3	25.40	<i>1.000</i>	151.0	<i>5.940</i>	38.10	<i>1.500</i>	27.90	<i>1.100</i>	158.80	<i>6.250</i>	87.30	<i>3.436</i>
PVF100743WE1	1,000	3	25.40	<i>1.000</i>	188.9	<i>7.437</i>	38.10	<i>1.500</i>	27.90	<i>1.100</i>	195.30	<i>7.688</i>	87.30	<i>3.436</i>
PVF190319WE2.5	2,500	2	48.30	<i>1.900</i>	81.00	<i>3.190</i>	19.10	<i>0.750</i>	50.80	<i>2.000</i>	87.40	<i>3.440</i>	105.10	<i>4.138</i>
PVF190594WE1	1,000	2	48.30	<i>1.900</i>	151.00	<i>5.940</i>	38.10	<i>1.500</i>	50.80	<i>2.000</i>	158.80	<i>6.250</i>	105.10	<i>4.138</i>
PVF200143WE2.5	2,500	2	50.80	<i>2.000</i>	36.50	<i>1.437</i>	12.70	<i>0.500</i>	50.80	<i>2.000</i>	42.20	<i>1.661</i>	107.60	<i>4.236</i>
PVF200225WE2.5	2,500	2	50.80	<i>2.000</i>	57.20	<i>2.250</i>	19.10	<i>0.750</i>	50.80	<i>2.000</i>	66.70	<i>2.625</i>	107.60	<i>4.236</i>
PVF200375WE2.5	2,500	2	50.80	<i>2.000</i>	95.30	<i>3.750</i>	25.40	<i>1.000</i>	53.30	<i>2.100</i>	101.60	<i>4.000</i>	111.40	<i>4.386</i>
PVF200743WE1	1,000	2	50.80	<i>2.000</i>	188.90	<i>7.437</i>	38.10	<i>1.500</i>	53.30	<i>2.100</i>	195.30	<i>7.688</i>	110.10	<i>4.336</i>

Options

Colors                      Standard                      White with clear tail

## TW Dot matrix printable self-laminating labels

Tyco TW is a dot matrix printable, translucent vinyl film with a permanent acrylic adhesive, supplied with a white printable area, which is over-laminated upon application with the translucent portion of the label. This 'self-laminating' feature protects the printed area from exposure to oil, solvents, water and abrasion. TW labels offer excellent conformability to round, irregular or flexible surfaces, and are ideal for wire and cable identification, including flat ribbon cables that are subject to repeated bending. They are UL and CSA Listed, with guaranteed print performance and durability, when used with Tyco's RI Quick Dry series ribbon.

### Features and benefits

- Manufactured with a white coated area for printing or writing on, and with a clear wrap to wind around a wire or cable over the printed surface to seal out impurities that would cause the label to become illegible.
- Protects printed information from chemicals and frequent handling.
- Designed to withstand exposure to oil, solvents, and water.
- Can also be flagged around a wire rather than wrapped.



### Temperature rating

Operating temperature range       $-40^{\circ}\text{C}$  to  $+80^{\circ}\text{C}$        $-40^{\circ}\text{F}$  to  $+176^{\circ}\text{F}$

### Printer information

Tyco printer      L0870\* (dot matrix)  
Tyco ribbon      1330-0037-00\* (dot matrix)

\* Alternative printers and ribbons are available for special applications. Contact Tyco Electronics Identification for more information.

### Part numbering system





**TW Dot matrix printable self-laminating labels (Cont'd)**

**Ordering information**



**Available sizes and formats**

Ordering description	Package quantity	Labels across	(A) Label width		(B) Label height		(C) Printable height		(D) Horizontal repeat		(E) Vertical repeat		(F) Web width	
			mm	<i>inches</i>	mm	<i>inches</i>	mm	<i>inches</i>	mm	<i>inches</i>	mm	<i>inches</i>	mm	<i>inches</i>
J-TW10	10,000	12	12.70	<i>0.500</i>	19.10	<i>0.750</i>	9.50	<i>0.375</i>	15.20	<i>0.600</i>	25.40	<i>1.000</i>	205.70	<i>8.100</i>
N-TW10	10,000	16	12.70	<i>0.500</i>	36.50	<i>1.437</i>	12.70	<i>0.500</i>	12.70	<i>0.500</i>	38.10	<i>1.500</i>	228.60	<i>9.000</i>
Q-TW10	10,000	9	19.10	<i>0.750</i>	44.50	<i>1.750</i>	12.70	<i>0.500</i>	22.90	<i>0.900</i>	50.80	<i>2.000</i>	227.30	<i>8.950</i>
A-TW10	10,000	6	20.30	<i>0.800</i>	36.50	<i>1.437</i>	12.70	<i>0.500</i>	22.90	<i>0.900</i>	38.10	<i>1.500</i>	160.00	<i>6.300</i>
O-TW10	10,000	8	25.40	<i>1.000</i>	36.50	<i>1.437</i>	12.70	<i>0.500</i>	25.40	<i>1.000</i>	38.10	<i>1.500</i>	228.60	<i>9.000</i>
R-TW5	5,000	8	25.40	<i>1.000</i>	57.20	<i>2.250</i>	19.10	<i>0.750</i>	25.40	<i>1.000</i>	63.50	<i>2.500</i>	228.60	<i>9.000</i>
T-TW2.5	2,500	8	25.40	<i>1.000</i>	95.30	<i>3.750</i>	25.40	<i>1.000</i>	25.40	<i>1.000</i>	101.60	<i>4.000</i>	228.60	<i>9.000</i>
W1-TW1	1,000	8	25.40	<i>1.000</i>	150.90	<i>5.940</i>	38.10	<i>1.500</i>	25.40	<i>1.000</i>	152.40	<i>6.000</i>	228.60	<i>9.000</i>
D1-TW1	1,000	7	25.40	<i>1.000</i>	188.90	<i>7.437</i>	38.10	<i>1.500</i>	27.90	<i>1.100</i>	190.50	<i>7.500</i>	218.40	<i>8.600</i>
C1-TW2.5	2,500	3	48.30	<i>1.900</i>	81.00	<i>3.190</i>	19.10	<i>0.750</i>	50.80	<i>2.000</i>	88.90	<i>3.500</i>	175.30	<i>6.900</i>
P-TW5	5,000	4	50.80	<i>2.000</i>	36.50	<i>1.437</i>	12.70	<i>0.500</i>	50.80	<i>2.000</i>	38.10	<i>1.500</i>	228.60	<i>9.000</i>
S-TW2.5	2,500	4	50.80	<i>2.000</i>	57.20	<i>2.250</i>	19.10	<i>0.750</i>	50.80	<i>2.000</i>	63.50	<i>2.500</i>	228.60	<i>9.000</i>
U-TW2.5	2,500	4	50.80	<i>2.000</i>	95.30	<i>3.750</i>	25.40	<i>1.000</i>	50.80	<i>2.000</i>	101.60	<i>4.000</i>	228.60	<i>9.000</i>
W2-TW1	1,000	3	50.80	<i>2.000</i>	150.90	<i>5.940</i>	38.10	<i>1.500</i>	53.30	<i>2.100</i>	152.40	<i>6.000</i>	182.90	<i>7.200</i>
D3-TW1	1,000	3	50.80	<i>2.000</i>	188.90	<i>7.437</i>	38.10	<i>1.500</i>	55.90	<i>2.200</i>	190.50	<i>7.500</i>	188.00	<i>7.400</i>

**Options**

Colors	Standard	White with clear tail
--------	----------	-----------------------

**tyco****Electronics**

Self-Laminating Labels

**PV Polyvinylfluoride dot matrix printable self-laminating labels**

Tyco PV is a dot matrix printable, translucent polyvinyl fluoride (Tedlar®) film with a permanent acrylic adhesive, designed for wire and cable marking applications that require the 'self-extinguishing' properties of Tedlar®. PV labels are supplied with a white printable area, which is over-laminated upon application with the translucent portion of the label. This 'self-laminating' feature protects the printed area from exposure to oil, solvents, water and abrasion. The low-profile design makes PV suitable for wrapping onto thin wire gauges. For guaranteed print performance and durability, use with Tyco's RI Quick Dry series ribbon.

**Features and benefits**

- Resists water, oils, and conventional cleaning agents.
- Filters UV light.
- Exhibits high degree of resistance to ageing.
- Thermal transfer printable.

**Temperature rating**

Operating temperature range    -40°C to +105°C    -40°F to +221°F

**Printer information**

Tyco printer    LQ870\* (dot matrix)  
Tyco ribbon    1330-0037-00\* (dot matrix)

*\*Alternative printers and ribbons are available for special applications. Contact Tyco Electronics Identification for more information.*

**Part numbering system**

N-PV 10



Ordering information



Available sizes and formats

Ordering description	Package quantity	Labels across	(A) Label width		(B) Label height		(C) Printable height		(D) Horizontal repeat		(E) Vertical repeat		(F) Web width	
			mm	<i>inches</i>	mm	<i>inches</i>	mm	<i>inches</i>	mm	<i>inches</i>	mm	<i>inches</i>	mm	<i>inches</i>
J-PV10	10,000	12	12.70	<i>0.500</i>	19.10	<i>0.750</i>	9.50	<i>0.375</i>	15.20	<i>0.600</i>	25.40	<i>1.000</i>	205.70	<i>8.100</i>
N-PV10	10,000	16	12.70	<i>0.500</i>	36.50	<i>1.437</i>	12.70	<i>0.500</i>	12.70	<i>0.500</i>	38.10	<i>1.500</i>	228.60	<i>9.000</i>
Q-PV10	10,000	9	19.10	<i>0.750</i>	44.50	<i>1.750</i>	12.70	<i>0.500</i>	22.90	<i>0.900</i>	50.80	<i>2.000</i>	227.30	<i>8.950</i>
A-PV10	10,000	6	20.30	<i>0.800</i>	36.50	<i>1.437</i>	12.70	<i>0.500</i>	22.90	<i>0.900</i>	38.10	<i>1.500</i>	160.00	<i>6.300</i>
O-PV10	10,000	8	25.40	<i>1.000</i>	36.50	<i>1.437</i>	12.70	<i>0.500</i>	25.40	<i>1.000</i>	38.10	<i>1.500</i>	228.60	<i>9.000</i>
R-PV5	5,000	8	25.40	<i>1.000</i>	57.20	<i>2.250</i>	19.10	<i>0.750</i>	25.40	<i>1.000</i>	63.50	<i>2.500</i>	228.60	<i>9.000</i>
T-PV2.5	2,500	8	25.40	<i>1.000</i>	95.30	<i>3.750</i>	25.40	<i>1.000</i>	25.40	<i>1.000</i>	101.60	<i>4.000</i>	228.60	<i>9.000</i>
W1-PV1	1,000	8	25.40	<i>1.000</i>	150.90	<i>5.940</i>	38.10	<i>1.500</i>	25.40	<i>1.000</i>	152.40	<i>6.000</i>	228.60	<i>9.000</i>
D1-PV1	1,000	7	25.40	<i>1.000</i>	188.90	<i>7.437</i>	38.10	<i>1.500</i>	27.90	<i>1.100</i>	190.50	<i>7.500</i>	218.40	<i>8.600</i>
C1-PV2.5	2,500	3	48.30	<i>1.900</i>	81.00	<i>3.190</i>	19.10	<i>0.750</i>	50.80	<i>2.000</i>	88.90	<i>3.500</i>	175.30	<i>6.900</i>
P-PV5	5,000	4	50.80	<i>2.000</i>	36.50	<i>1.437</i>	12.70	<i>0.500</i>	50.80	<i>2.000</i>	38.10	<i>1.500</i>	228.60	<i>9.000</i>
S-PV2.5	2,500	4	50.80	<i>2.000</i>	57.20	<i>2.250</i>	19.10	<i>0.750</i>	50.80	<i>2.000</i>	63.50	<i>2.500</i>	228.60	<i>9.000</i>
U-PV2.5	2,500	4	50.80	<i>2.000</i>	95.30	<i>3.750</i>	25.40	<i>1.000</i>	50.80	<i>2.000</i>	101.60	<i>4.000</i>	228.60	<i>9.000</i>
W2-PV1	1,000	3	50.80	<i>2.000</i>	150.90	<i>5.940</i>	38.10	<i>1.500</i>	53.30	<i>2.100</i>	152.40	<i>6.000</i>	182.90	<i>7.200</i>
D3-PV1	1,000	3	50.80	<i>2.000</i>	188.90	<i>7.437</i>	38.10	<i>1.500</i>	55.90	<i>2.200</i>	190.50	<i>7.500</i>	188.00	<i>7.400</i>

Options

Colors	Standard	White with clear tail
--------	----------	-----------------------

**tyco****Electronics**

Self-Laminating Labels

**LSR Laser printable self-laminating labels**

Tyco LSR is a laser printable, translucent polyester film with a permanent acrylic adhesive, supplied with a white printable area, which is over-laminated upon application with the translucent portion of the label. This 'self-laminating' feature protects the printed area from exposure to oil, solvents, water and abrasion with good conformability to round surfaces. LSR is ideal for wire and cable marking including flat ribbon cable. The low-profile design makes LSR suitable for wrapping onto thin wire gauges.

**Features and benefits**

- Manufactured with a white coated area for printing or writing on, and with a clear wrap to wind around a wire or cable over the printed surface to seal out impurities that would cause the label to become illegible.
- Protects printed information from chemicals and frequent handling.
- Designed to withstand exposure to oil, solvents, and water.
- Can also be flagged around a wire rather than wrapped.

**Temperature rating**

Operating temperature range     $-40^{\circ}\text{C}$  to  $+150^{\circ}\text{C}$      $-40^{\circ}\text{F}$  to  $+302^{\circ}\text{F}$

**Printer information**

Standard laser printer with auto/manual sheet feed.  
 Contact Tyco Electronics Identification for more information.

**LSR Laser printable self-laminating labels** (Cont'd)

Ordering information



Available sizes and formats

Ordering description	Package quantity	Labels across	Labels per sheet	(A) Label width		(B) Label height		(C) Printable height		(D) Horizontal repeat		(E) Vertical repeat	
				mm	<i>inches</i>	mm	<i>inches</i>	mm	<i>inches</i>	mm	<i>inches</i>	mm	<i>inches</i>
CR-100-LSR	4,992	13	156	12.70	<i>0.500</i>	19.10	<i>0.750</i>	9.40	<i>0.370</i>	15.20	<i>0.600</i>	20.60	<i>0.810</i>
CR-101-LSR	4,992	13	78	12.70	<i>0.500</i>	38.10	<i>1.500</i>	12.70	<i>0.500</i>	15.20	<i>0.600</i>	40.60	<i>1.600</i>
CR-105-LSR	5,040	7	84	25.40	<i>1.000</i>	19.10	<i>0.750</i>	8.60	<i>0.340</i>	27.90	<i>1.100</i>	20.60	<i>0.810</i>
CR-106-LSR	2,520	7	63	25.40	<i>1.000</i>	25.40	<i>1.000</i>	8.60	<i>0.340</i>	27.90	<i>1.100</i>	27.90	<i>1.100</i>
CR-107-LSR	2,499	7	49	25.40	<i>1.000</i>	33.80	<i>1.330</i>	12.70	<i>0.500</i>	27.90	<i>1.100</i>	36.60	<i>1.440</i>
CR-108-LSR	1,008	7	21	25.40	<i>1.000</i>	80.50	<i>3.170</i>	24.60	<i>0.970</i>	27.90	<i>1.100</i>	84.10	<i>3.310</i>
CR-110-LSR	1,008	4	12	47.80	<i>1.880</i>	80.50	<i>3.170</i>	24.60	<i>0.970</i>	50.80	<i>2.000</i>	83.30	<i>3.280</i>

**Self-Laminating Label Dimensions**



**Self-Laminating Label Dimensions** (Cont'd)



**tyco****Electronics**

Pre-Printed Wire &amp; Cable Markers

**K-Type™ cable markers**

K-Type™ markers are used to identify wire bundles, cables, pipes and conduits using specially designed oval shaped, individual characters that slide on to a PVC carrier, which is then attached to the substrate using cable ties. K-Type™ markers are ideal for post termination applications or where retrofit is anticipated.

These markers are supplied yellow with black legends and in the standard International colour code option and are supplied on reels. K-Type™ markers come in one standard size to fit carrier strips that can hold from 7 to 18 markers and are made from a plasticized PVC material.

**Features and benefits**

- Versatile marking system for cables, cable bundles and conduit.
- Elliptical marker profile allows easy fitting to carrier strips.

**Temperature rating**

Operating temperature range      -40°C to +70°C      -40°F to +158°F

**Part numbering system**

1361-1-4-01

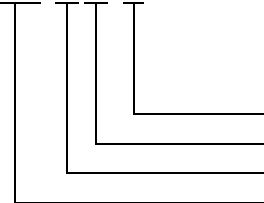

Legend code  
Color code (eg., 4=yellow)  
Pack code (eg., 1=reel)  
Product/size code



#### K-Type™ cable markers (Cont'd)

##### Ordering information

###### MARKERS

Order code	Marker size	Cable diameter (mm)	Reel quantity
1361	65	4.2 – 7.0	500

###### CARRIER STRIPS

Order code	Capacity	Quantity
11320000	7 markers	500
11310000	12 markers	500
11300000	18 markers	250
11330000 *	12 markers	100

\* This carrier can be used to flag

##### International color code

Legend	Color	Legend	Color	Legend	Color	Legend	Color
0	Black	1	Brown	2	Red	3	Orange
4	Yellow	5	Green	6	Blue	7	Violet
8	Gray	9	White				

##### Legend code

Legend	Code	Legend	Code	Legend	Code
0	00	J	19	/	38
1	01	K	20	~	39
2	02	L	21	Earth	40
3	03	M	22	)	41
4	04	N	23	Blank	42
5	05	O	24	:	43
6	06	P	25	,	44
7	07	Q	26	<	45
8	08	R	27	>	46
9	09	S	28	+	47
A	10	T	29	.	48
B	11	U	30		
C	12	V	31		
D	13	W	32		
E	14	X	33		
F	15	Y	34		
G	16	Z	35		
H	17	+	36		
I	18	-	37		

**Z-type™ push-on wire markers**

Z-Type™ markers are individual push-on characters used to identify wires and small cables permanently. They are designed with an expanding profile, enabling each marker to accommodate a wide range of wire/cable sizes. Z-Type™ markers are a simple, cost-effective solution for many commercial wire identification applications. The markers are supplied either straight cut or chevron cut: the chevron cut option ensures the legends remain aligned. Standard Z-Type™ markers are yellow or white with black legends and can be supplied as loose pieces packed in boxes or on reels. Color coded markers are also available.

**Features and benefits**

- Resistant to sea water, fuels and oils.
- 9 sizes covering wire diameters from 1.5mm to 12.7mm (0.06 inches to 0.5 inches)
- Applicator wands available for easy marker installation.



Temperature rating		
Operating temperature range	-45°C to +70°C	-50°F to +158°F

**Part numbering system**



**Ordering information**

Order code (straight cut)	Order code (chevron cut)	Marker size	Pack quantity	Cable diameter
0580	1151	5	1000	1.5 - 2.0 (0.06 - 0.08)
0581	1152	7	1000	2.0 - 3.2 (0.08 - 0.13)
0615	1153	9	1000	2.5 - 4.0 (0.10 - 0.16)
0616	1154	11	1000	2.9 - 4.7 (0.11 - 0.19)
0617	1155	13	1000	3.4 - 5.7 (0.13 - 0.22)
0618	1156	15	1000	3.8 - 6.3 (0.15 - 0.25)
0620	1157	18	500	4.3 - 6.9 (0.17 - 0.27)
0622	1158	23	500	5.5 - 8.9 (0.22 - 0.35)
0624	1159	35	250	7.9 - 12.7 (0.31 - 0.50)

**Color code:** Color coded markers conform to the international standard system (0 on a black marker, 1 on a brown marker, etc.) To order color coded markers replace the last three characters of the order code as follows:

Legend	Marker Colour	Order Code	Legend	Marker Colour	Order Code
0	Black	000	1	Brown	101
2	Red	202	3	Orange	303
4	Yellow	404	5	Green	505
6	Blue	606	7	Violet	707
8	Gray	808	9	White	909

Order example:

06161400 (Z-Type™ markers, size 11, yellow marker with black legend 0, boxed)

**Applicators**

Order Code	Marker Size	Pack Quantity	Order Code	Marker Size	Pack Quantity
12510000	7	1	12520000	9	1
12530000	11	1	12540000	13	1
12550000	15	1	12560000	18	1

**Legend code**

Legend	Code	Legend	Code	Legend	Code
0	00	J	19	/	38
1	01	K	20	~	39
2	02	L	21	Earth	40
3	03	M	22	)	41
4	04	N	23	Blank	42
5	05	O	24	:	43
6	06	P	25	,	44
7	07	Q	26	<	45
8	08	R	27	>	46
9	09	S	28	+	47
A	10	T	29	.	48
B	11	U	30		
C	12	V	31		
D	13	W	32		
E	14	X	33		
F	15	Y	34		
G	16	Z	35		
H	17	+	36		
I	18	-	37		

**Packaging Options available**

Straight Cut		Chevron cut	
White marker with black legend:	Boxes, reels	White marker with black legend:	Boxes
Yellow marker with black legend:	Reels	Yellow marker with black legend:	Reels
Color coded	Boxes	Color coded	Boxes, reels

**Snap-On Markers**

Tyco snap-on markers are convenient and easy to use. These markers are supplied on a 'wand' applicator that simplifies and reduces installation time, and saves on the cost of marking.

Snap-on markers are designed to stand the test of time, preventing costly re-work before the life of the equipment ends. This is why Tyco snap-on markers are found today in power stations, oil refineries, offshore platforms, and other major projects around the world.

**Features and benefits**

- Snap-on markers are the perfect way to permanently and rapidly mark cables, wires, leads, and cores after termination and installation.
- Easy to alter identification on cables that are already marked.
- Secure grip for positive fixing to cable.
- The high elasticity of the marker enables all types of installation and conduction material to be permanently marked without damage.
- Applicator has a patented slit to prevent over-expansion of the marker during application.
- Made from polyoxymethylene which guarantees strength, dimensional stability, low moisture absorption, and resistance to chemicals.
- Resistant against oils, cleaning agents, fuels, and alkaline solutions.
- Zero-halogen material.
- Ten sizes for cable diameters 0.04" to 0.75" (1.0mm to 19.0mm).
- Color-coded option.



**Temperature rating**

Operating temperature range    -40°C to +106°C    -40°F to +223°F



**Part numbering system**



**Snap-On Markers (Cont'd)**

**Ordering information**

For Cable Diameter Inches	mm	Color of Mounting Wand	Packed Box	Order
0.040 - 0.055	1.00 - 1.40	Brown	10 mounting wands with 30 identical markers	STD 01
0.055 - 0.071	1.40 - 1.80	Gray	10 mounting wands with 30 identical markers	STD 02
0.075 - 0.104	1.90 - 2.65	Green	10 mounting wands with 30 identical markers	STD 03
0.102 - 0.138	2.60 - 3.50	Red	10 mounting wands with 30 identical markers	STD 06
0.128 - 0.177	3.25 - 4.50	Blue	10 mounting wands with 30 identical markers	STD 09
0.177 - 0.236	4.50 - 6.00	Yellow	10 mounting wands with 30 identical markers	STD 12
0.228 - 0.335	5.80 - 8.50	Orange*	50 identical markers; mounting wand available on request	STD 15
0.335 - 0.452	8.50 - 11.50	Orange*	50 identical markers; mounting wand available on request	STD 17
0.433 - 0.610	11.00 - 15.50	Gray*	50 identical markers; mounting wand available on request	STD 21
0.590 - 0.750	15.00 - 19.00	Gray*	50 identical markers; mounting wand available on request	STD 24

\*Mounting wands for STD 15, STD 17, STD 21, and STD 24 - Order Codes: STD 15MO, STD 17MO, STD 21MO, and ST 24MO  
 NOTE - All markers available 0-9,A-Z, (+), (-), (.), (/), (^), (v), (.), (.), and "blank"

**tyco****Electronics**

Pre-Printed Wire &amp; Cable Markers

**CWM Wire marker cards**

Tyco CWM are pre-printed wire markers made with our white vinyl coated cloth tape material, supplied on a thick, easy to handle card stock, with a permanent, rubber based, pressure sensitive adhesive for easy application. Ideal for basic wire marking applications where pre-printed single or double-digit legends and some resistance to a variety of solvents, water, oil, dirt and heat is required.

**Features and benefits**

- Convenient and easy to use.
- Pre-printed for on-site wire marking.
- Available in colors for color coding applications.
- Available in single and multiple digit legends.

**Temperature rating**

Operating temperature range    -40°C to +82°C    -40°F to +180°F

**CWM Wire marker cards (Cont'd)**

**Ordering information**

Product Order Code	Legend Option	Package Quantity	Label Width		Label Height		Card Width		Card Height	
			mm	inches	mm	inches	mm	inches	mm	inches
CWM-SL-# *	Solid Letters 0-99	25 Cards (825 labels)	6.4	0.250	38.1	1.500	235.0	9.250	50.8	2.000
CWM-SL-letter *	Solid Letters A - Z	25 Cards (825 labels)	6.4	0.250	38.1	1.500	235.0	9.250	50.8	2.000
CWM-SL-color *	Solid Colors	25 Cards (825 labels)	6.4	0.250	38.1	1.500	235.0	9.250	50.8	2.000
CWM-SL-legend *	Solid 2+ Digits	25 Cards (825 labels)	6.4	0.250	38.1	1.500	235.0	9.250	50.8	2.000
CWM-SQ-1-33	Sequential 1 - 33	25 Cards (825 labels)	6.4	0.250	38.1	1.500	235.0	9.250	50.8	2.000
CWM-SQ-34-66	Sequential 34 - 66	25 Cards (825 labels)	6.4	0.250	38.1	1.500	235.0	9.250	50.8	2.000
CWM-SQ-67-99	Sequential 67 - 99	25 Cards (825 labels)	6.4	0.250	38.1	1.500	235.0	9.250	50.8	2.000
CWM-SQ-A-Z	Sequential A - Z	25 Cards (825 labels)	6.4	0.250	38.1	1.500	235.0	9.250	50.8	2.000
CWM-SQ-AA-ZZ	Sequential AA - ZZ	25 Cards (825 labels)	6.4	0.250	38.1	1.500	235.0	9.250	50.8	2.000
CWM-SQ-a-z	Sequential a - z	25 Cards (825 labels)	6.4	0.250	38.1	1.500	235.0	9.250	50.8	2.000
CWM-SQ-1-6	Sequential 1 - 6	25 Cards (825 labels)	6.4	0.250	38.1	1.500	235.0	9.250	50.8	2.000
CWM-SQ-1-18	Sequential 1 - 18	25 Cards (825 labels)	6.4	0.250	38.1	1.500	235.0	9.250	50.8	2.000

\*Solid cards (SL) = 1 legend on each card. Select a single legend and add to the suffix of the product order code.  
 Sequential cards (SQ) = a consecutive range of alpha or numeric legends on each card, as specified in the suffix of the product order code.  
 Available options on product order code CWM-SL-legends are: T1, T2, T3, L1, L2, L3, GND, P1, A1, XS, PTO. Add legend suffix of order code.

**THERMAL TRANSFER LABELS**

WP White Polyester .....	66	T1K Standard Polyimide .....	85
CP Clear Polyester .....	68	T2K High-performance Polyimide ..	86
HW HighTack White Polyester .....	70	TAK Amber Polyimide .....	87
HM High Tack Metalized Polyester ..	72	TSK Static-safe Polyimide .....	88
MP Metalized Polyester .....	74	T2Y Modified Polyimide .....	89
MV Metalized Void Polyester .....	76	KTT Tan Polyimide .....	90
TN Destructible Polyethylene .....	78	PVF Polyvinyl Fluoride .....	92
WV White Vinyl .....	80	EP Paper .....	94
NC Nylon Cloth .....	82		



**DOT MATRIX LABELS**

C Vinyl Cloth .....	96
M Metalized Polyester .....	98
K Polyimide (Kapton®) .....	100
E Polyester .....	102



**LASER LABELS**

LE Polyester .....	104
LM Metalized Polyester .....	104
LEB2 Polyester .....	104





## Label format - Product order code / Cross reference

### Thermal transfer

Old label format	New product order code	Old label format	New product order code
100	TTP400XX-10	138	XX-080080-10-#
101	XX-381064-10-#	139	XX-178095-10-#
102	XX-381191-5-#	201	XX-381064-10-#
103	XX-699254-5-#	205	XX-191064-10-#
104	XX-762508-2.5-#	214	XX-508127-10-#
105	XX-191064-10-#	230	XX-203127-10-#
106	XX-101165-0.85-#	901	XX-127032-10-#
107	XX-254127-10-#	902	XX-040033-10-#
108	XX-064064-25-#	903	XX-254045-10-#
109	XX-165051-25-#	904	XX-089047-10-#
110	XX-254097-10-#	905	XX-305047-10-#
111	XX-318064-10-#	906	XX-445064-10-#
112	XX-508064-10-#	907	XX-254064-10-#
114	XX508127-10-#	908	XX-095080-25-#
115	XX-254254-10-#	909	XX-208086-5-#
116	XX-095095-10-#	911	XX-508095-5-#
117	XX-508318-2.5-#	912	XX-318097-10-#
118	XX-762381-2.5-#	913	XX-165102-10-#
119	XX-101635-2.5-#	914	XX-445102-5-#
121	XX-523841-1.5-#	916	XX-127127-10-#
122	XX-127111-10-#	917	XX-381127-5-#
123	XX-508254-5-#	918	XX-222159-15-#
124	XX-508508-3-#	919	XX-171171-10-#
125	XX-101508-2.5-#	920	XX-478175-5-#
126	XX-101762-1.8-#	921	XX-699191-5-#
127	XX-101101-1.3-#	922	XX-406254-1.5-#
128	XX-762127-1-#	923	XX-250381-10-#
129	XX-229064-10-#	924	XX-381381-2.5-#
130	XX-203127-10-#	925	XX-610419-2.5-#
132	XX-381020-10-#	926	XX-445445-2-#
134	XX-165051-25-#	927	XX-381635-5-#
136	XX-040040-25-#	928	XX-191762-5-#
137	XX-114040-25-#		

XX = Insert material code from table below. # = Insert color code from table below right.

#### Examples

Examples	Old part number	New part number
Thermal transfer	101-T1K-10	T1K-381064-10-9
Dot matrix	3-EW10F	E-191064-10-9

### Dot matrix

Old label format	New product order code
1	X-165051-10-#
3	X-191064-10-#
4	X-203127-10-#
5	X-254095-10-#
6A	X-508095-5-#
7	X-254127-10-#
8	X-381191-10-#
11	X-699254-2.5-#
12	X-920381-2.5-#
13	X-920254-2.5-#
16	X-203365-10-#
17	X-076191-10-#
B2	X-533064-5-#
B4	X-229064-10-#
B6	X-394064-10-#
E	X-203064-10-#
L1	X-080080-10-#
M	X-381064-10S1-9
L2	X-064064-10-#
L3	X-095095-10-#
R1	X-508254-4-#
R2	X-673254-3-#
R3	X-508318-3-#
R4	X-673349-3-#
R5	X-762508-1-#
R7	X-165101-1-#
V1	X-127111-10-#
Y3	X-215055-10-#
Y5	X-115064-10-#
Y6	X-154064-10-#
Y7	X-293064-10-#
Y8	X-711064-5-#
Y9	X-121064-10-#
Y10	X-102070-10-#
Y12	X-159079-10-#
Y13	X-533114-5-#
Y14	X-572286-2.5-#
Y15	X-699318-2.5-#

X = Insert material code from table below left.

# = Insert color code from table below.

#### Material codes - thermal transfer labels

CP = Clear polyester	T1K = Standard polyimide (Kapton®) 1 mil
EP = Paper	T2K = High-performance polyimide (Kapton®) 2 mil
HM = High tack metalized polyester	T2Y = Modified polyimide
HW = High tack white polyester	TAK = Amber polyimide (Kapton®) 2 mil
MP = Metalized polyester	TN = Tamper-proof polyethylene
MV = Tamper-evident metalized polyester	TSK = Static-safe polyimide (Kapton®)
NC = Nylon cloth	WP = White polyester
PVF = Polyvinyl fluoride (Tedlar®)	WV = White vinyl

#### Material codes - dot matrix labels

C = Vinyl cloth	K = Tan polyimide (Kapton®)
E = White polyester	M = Metalized polyester

#### Color codes

0 = Black	8 = Gray
1 = Brown	9 = White
2 = Red	X = Clear
3 = Orange	1A = Tan
4 = Yellow	2L = Pink
5 = Green	3A = Amber
6 = Blue	8A = Silver
7 = Violet	

**WP White polyester labels**

Tyco WP is a thermal transfer printable white polyester film with a permanent acrylic adhesive. It is ideal for bar coding, PCB and component labeling, as well as general purpose labeling applications that require a high durability white label. WP is resistant to a variety of solvents while maintaining print quality. It is UL Listed and CSA Certified, and print performance and durability are guaranteed when used with Tyco's RHD series ribbon.



**Features and benefits**

- Thermal transfer printable.
- Excellent for use in PCB component labeling.
- Ink receptive topcoat.
- Excellent for bar code applications.
- UL Listed and CSA Certified.



<b>Adhesive</b>	Permanent acrylic	
<b>Service temperature</b>	-40°C to +150°C	-40°F to +302°F
<b>Recommended printer</b>	T308S*	
<b>Recommended ribbon</b>	1330-0607-10*	
	<small>*Alternative printers and ribbons are available for special applications. Contact Tyco Electronics Identification for more information.</small>	

**Part numbering system**

WP-044033-10-9



**Ordering information**



**Product dimensions**

Product order code	Package quantity	Labels across	Label width (A)		Label height (B)		Horizontal repeat (C)		Vertical repeat (D)		Web width (E)	
			mm	<i>inches</i>	mm	<i>inches</i>	mm	<i>inches</i>	mm	<i>inches</i>	mm	<i>inches</i>
WP-040040-25-9	25,000	20	4.0	<i>0.157</i>	4.0	<i>0.157</i>	4.0	<i>0.157</i>	7.2	<i>0.281</i>	86.0	<i>3.380</i>
WP-044033-10-9	10,000	20	4.4	<i>0.170</i>	3.3	<i>0.130</i>	4.4	<i>0.170</i>	9.5	<i>0.375</i>	92.4	<i>3.638</i>
WP-064064-25-9	25,000	12	6.4	<i>0.250</i>	6.4	<i>0.250</i>	6.4	<i>0.250</i>	9.5	<i>0.375</i>	82.2	<i>3.240</i>
WP-080080-10-9	10,000	8	8.0	<i>0.315</i>	8.0	<i>0.315</i>	9.9	<i>0.390</i>	13.3	<i>0.525</i>	83.3	<i>3.280</i>
WP-089047-10-9	10,000	5	8.9	<i>0.350</i>	4.7	<i>0.185</i>	11.4	<i>0.450</i>	7.9	<i>0.313</i>	60.6	<i>2.386</i>
WP-095080-25-9	25,000	5	9.5	<i>0.375</i>	8.0	<i>0.315</i>	12.2	<i>0.480</i>	12.7	<i>0.500</i>	64.3	<i>2.531</i>
WP-095095-10-9	10,000	7	9.5	<i>0.375</i>	9.5	<i>0.375</i>	11.1	<i>0.437</i>	12.7	<i>0.500</i>	82.1	<i>3.230</i>
WP-114040-25-9	25,000	6	11.4	<i>0.450</i>	4.0	<i>0.157</i>	11.4	<i>0.450</i>	7.2	<i>0.281</i>	74.6	<i>2.940</i>
WP-127032-10-9	10,000	5	12.7	<i>0.500</i>	3.2	<i>0.125</i>	19.1	<i>0.750</i>	3.2	<i>0.250</i>	94.9	<i>3.736</i>

(continued)

**Product dimensions (continued)**

Product order code	Package quantity	Labels across	Label width (A) mm <i>inches</i>	Label height (B) mm <i>inches</i>	Horizontal repeat (C) mm <i>inches</i>	Vertical repeat (D) mm <i>inches</i>	Web width (E) mm <i>inches</i>
WP-127111-10-9	10,000	5	12.7 <i>0.500</i>	11.1 <i>0.437</i>	16.8 <i>0.662</i>	14.3 <i>0.563</i>	86.0 <i>3.380</i>
WP-127127-10-9	10,000	5	12.7 <i>0.500</i>	12.7 <i>0.500</i>	15.9 <i>0.625</i>	15.9 <i>0.625</i>	82.6 <i>3.250</i>
WP-165051-25-9	25,000	4	16.5 <i>0.650</i>	5.1 <i>0.200</i>	17.8 <i>0.700</i>	8.3 <i>0.325</i>	75.8 <i>2.990</i>
WP-165102-10-9	10,000	5	16.5 <i>0.650</i>	10.2 <i>0.400</i>	19.1 <i>0.750</i>	13.8 <i>0.545</i>	99.1 <i>3.900</i>
WP-171171-10-9	10,000	5	17.1 <i>0.674</i>	17.1 <i>0.674</i>	19.7 <i>0.774</i>	20.3 <i>0.800</i>	101.8 <i>4.006</i>
WP-178095-10-9	10,000	4	17.8 <i>0.700</i>	9.5 <i>0.375</i>	19.1 <i>0.750</i>	12.7 <i>0.500</i>	80.9 <i>3.190</i>
WP-191064-10-9	10,000	4	19.1 <i>0.750</i>	6.4 <i>0.250</i>	21.6 <i>0.850</i>	9.5 <i>0.375</i>	89.9 <i>3.540</i>
WP-191114-15-9	15,000	3	19.1 <i>0.750</i>	11.4 <i>0.450</i>	22.2 <i>0.875</i>	14.7 <i>0.579</i>	69.5 <i>2.736</i>
WP-191762-5-9	5,000	3	19.1 <i>0.750</i>	76.2 <i>3.000</i>	21.6 <i>0.850</i>	88.9 <i>3.500</i>	68.2 <i>2.686</i>
WP-203127-10-9	10,000	4	20.3 <i>0.800</i>	12.7 <i>0.500</i>	22.9 <i>0.900</i>	15.9 <i>0.625</i>	94.6 <i>3.730</i>
WP-208086-5-9	5,000	4	20.8 <i>0.820</i>	8.6 <i>0.340</i>	24.1 <i>0.950</i>	12.7 <i>0.500</i>	101.6 <i>4.000</i>
WP-222159-15-9	15,000	2	22.2 <i>0.875</i>	15.9 <i>0.625</i>	24.8 <i>0.975</i>	19.1 <i>0.750</i>	53.0 <i>2.086</i>
WP-229064-10-9	10,000	3	22.9 <i>0.900</i>	6.4 <i>0.250</i>	28.6 <i>1.125</i>	9.5 <i>0.375</i>	86.0 <i>3.390</i>
WP-250381-10-9	10,000	4	24.9 <i>0.980</i>	38.1 <i>1.500</i>	27.4 <i>1.080</i>	47.6 <i>1.875</i>	113.5 <i>4.470</i>
WP-254045-10-9	10,000	3	25.4 <i>1.000</i>	4.6 <i>0.180</i>	31.8 <i>1.250</i>	8.5 <i>0.333</i>	95.3 <i>3.750</i>
WP-254064-10-9	10,000	3	25.4 <i>1.000</i>	6.4 <i>0.250</i>	27.9 <i>1.100</i>	9.5 <i>0.375</i>	87.3 <i>3.436</i>
WP-254097-10-9	10,000	3	25.4 <i>1.000</i>	9.7 <i>0.380</i>	27.9 <i>1.100</i>	12.7 <i>0.500</i>	87.4 <i>3.440</i>
WP-254127-10-9	10,000	3	25.4 <i>1.000</i>	12.7 <i>0.500</i>	27.9 <i>1.100</i>	16.9 <i>0.666</i>	87.4 <i>3.440</i>
WP-254254-10-9	10,000	3	25.4 <i>1.000</i>	25.4 <i>1.000</i>	27.9 <i>1.100</i>	28.6 <i>1.125</i>	87.4 <i>3.440</i>
WP-305047-10-9	10,000	2	30.5 <i>1.200</i>	4.7 <i>0.185</i>	33.0 <i>1.300</i>	7.8 <i>0.306</i>	69.5 <i>2.736</i>
WP-318064-10-9	10,000	1	31.8 <i>1.250</i>	6.4 <i>0.250</i>	N/A N/A	9.5 <i>0.375</i>	37.9 <i>1.490</i>
WP-318097-10-9	10,000	1	31.8 <i>1.250</i>	9.7 <i>0.380</i>	N/A N/A	12.7 <i>0.500</i>	37.8 <i>1.488</i>
WP-381020-10-9	10,000	1	38.1 <i>1.500</i>	2.0 <i>0.080</i>	N/A N/A	10.7 <i>0.423</i>	44.1 <i>1.740</i>
WP-381064-10-9	10,000	1	38.1 <i>1.500</i>	6.4 <i>0.250</i>	N/A N/A	9.5 <i>0.375</i>	44.5 <i>1.750</i>
WP-381127-5-9	5,000	2	38.1 <i>1.500</i>	12.7 <i>0.500</i>	44.2 <i>1.740</i>	15.9 <i>0.630</i>	88.2 <i>3.470</i>
WP-381191-5-9	5,000	2	38.1 <i>1.500</i>	19.1 <i>0.750</i>	43.2 <i>1.700</i>	22.2 <i>0.875</i>	87.6 <i>3.450</i>
WP-381381-2.5-9	2,500	2	38.1 <i>1.500</i>	38.1 <i>1.500</i>	44.5 <i>1.750</i>	40.8 <i>1.610</i>	88.9 <i>3.500</i>
WP-381635-5-9	5,000	2	38.1 <i>1.500</i>	63.5 <i>2.500</i>	40.6 <i>1.600</i>	66.7 <i>2.630</i>	84.7 <i>3.340</i>
WP-406254-1.5-9	1,500	2	40.6 <i>1.600</i>	25.4 <i>1.000</i>	55.9 <i>2.200</i>	38.1 <i>1.500</i>	102.9 <i>4.050</i>
WP-445064-10-9	10,000	1	44.5 <i>1.750</i>	6.4 <i>0.250</i>	N/A N/A	9.5 <i>0.375</i>	50.4 <i>1.986</i>
WP-445102-5-9	5,000	1	44.5 <i>1.750</i>	10.2 <i>0.400</i>	N/A N/A	12.7 <i>0.500</i>	50.4 <i>1.986</i>
WP-445445-2-9	2,000	1	44.5 <i>1.750</i>	44.5 <i>1.750</i>	N/A N/A	47.6 <i>1.875</i>	50.4 <i>1.986</i>
WP-478175-5-9	5,000	1	47.8 <i>1.880</i>	17.5 <i>0.690</i>	N/A N/A	24.4 <i>0.962</i>	66.0 <i>2.600</i>
WP-508064-10-9	10,000	1	50.8 <i>2.000</i>	6.4 <i>0.250</i>	N/A N/A	9.5 <i>0.375</i>	56.9 <i>2.240</i>
WP-508095-5-9	5,000	1	50.8 <i>2.000</i>	9.5 <i>0.375</i>	N/A N/A	12.7 <i>0.500</i>	57.2 <i>2.250</i>
WP-508127-10-9	10,000	1	50.8 <i>2.000</i>	12.7 <i>0.500</i>	N/A N/A	15.9 <i>0.625</i>	56.9 <i>2.240</i>
WP-508254-5-9	5,000	1	50.8 <i>2.000</i>	25.4 <i>1.000</i>	N/A N/A	28.6 <i>1.125</i>	57.2 <i>2.250</i>
WP-508318-2.5-9	2,500	1	50.8 <i>2.000</i>	31.8 <i>1.250</i>	N/A N/A	34.9 <i>1.375</i>	56.9 <i>2.240</i>
WP-508508-3-9	3,000	1	50.8 <i>2.000</i>	50.8 <i>2.000</i>	N/A N/A	54.6 <i>2.150</i>	54.0 <i>2.130</i>
WP-523841-1.5-9	1,500	1	52.3 <i>2.060</i>	84.1 <i>3.310</i>	N/A N/A	88.9 <i>3.500</i>	58.2 <i>2.290</i>
WP-610419-2.5-9	2,500	1	61.0 <i>2.400</i>	41.9 <i>1.650</i>	N/A N/A	45.5 <i>1.792</i>	67.3 <i>2.650</i>
WP-699191-5-9	5,000	1	69.9 <i>2.750</i>	19.1 <i>0.750</i>	N/A N/A	23.3 <i>0.917</i>	76.2 <i>3.000</i>
WP-699254-5-9	5,000	1	69.9 <i>2.750</i>	25.4 <i>1.000</i>	N/A N/A	28.6 <i>1.125</i>	76.2 <i>3.000</i>
WP-762381-2.5-9	2,500	1	76.2 <i>3.000</i>	38.1 <i>1.500</i>	N/A N/A	41.3 <i>1.625</i>	82.3 <i>3.240</i>
WP-762508-2.5-9	2,500	1	76.2 <i>3.000</i>	50.8 <i>2.000</i>	N/A N/A	54.0 <i>2.125</i>	82.6 <i>3.240</i>
WP-762127-1-9	1,000	1	76.2 <i>3.000</i>	127.0 <i>5.000</i>	N/A N/A	129.5 <i>5.100</i>	79.4 <i>3.130</i>
WP-101508-2.5-9	2,500	1	101.6 <i>4.000</i>	50.8 <i>2.000</i>	N/A N/A	54.6 <i>2.150</i>	104.1 <i>4.100</i>
WP-101635-2.5-9	2,500	1	101.6 <i>4.000</i>	63.5 <i>2.500</i>	N/A N/A	66.7 <i>2.625</i>	107.7 <i>4.240</i>
WP-101762-1.8-9	1,800	1	101.6 <i>4.000</i>	76.2 <i>3.000</i>	N/A N/A	79.4 <i>3.125</i>	104.1 <i>4.100</i>
WP-101101-1.3-9	1,300	1	101.6 <i>4.000</i>	101.6 <i>4.000</i>	N/A N/A	104.8 <i>4.125</i>	104.1 <i>4.100</i>
WP-101165-0.85-9	850	1	101.6 <i>4.000</i>	165.1 <i>6.500</i>	N/A N/A	168.3 <i>6.680</i>	104.9 <i>4.130</i>

**CP Clear polyester labels**

Tyco CP is a clear polyester film with a permanent acrylic adhesive. CP is ideal for use as an over-laminate to further protect printed labels from chemicals, solvents, abrasion, heat and moisture.

**Features and benefits**

- Ideal for applications where either a clear label or laminate is required.



<b>Adhesive</b>	Permanent acrylic	
<b>Service temperature</b>	-40°C to +150°C	-40°F to +302°F

**Part numbering system**

CP-044033-10-X



**Ordering information**



**Product dimensions**

Product order code	Package quantity	Labels across	Label width (A) mm <i>inches</i>	Label height (B) mm <i>inches</i>	Horizontal repeat (C) mm <i>inches</i>	Vertical repeat (D) mm <i>inches</i>	Web width (E) mm <i>inches</i>
CP-040040-25-X	25,000	20	4.0 <i>0.157</i>	4.0 <i>0.157</i>	4.0 <i>0.157</i>	7.2 <i>0.281</i>	86.0 <i>3.380</i>
CP-044033-10-X	10,000	20	4.4 <i>0.170</i>	3.3 <i>0.130</i>	4.4 <i>0.170</i>	9.5 <i>0.375</i>	92.4 <i>3.636</i>
CP-064064-25-X	25,000	12	6.4 <i>0.250</i>	6.4 <i>0.250</i>	6.4 <i>0.250</i>	9.5 <i>0.375</i>	82.2 <i>3.240</i>
CP-080080-10-X	10,000	8	8.0 <i>0.315</i>	8.0 <i>0.315</i>	9.9 <i>0.390</i>	13.3 <i>0.525</i>	83.3 <i>3.280</i>
CP-089047-10-X	10,000	5	8.9 <i>0.350</i>	4.7 <i>0.185</i>	11.4 <i>0.450</i>	7.9 <i>0.313</i>	60.6 <i>2.386</i>
CP-095080-25-X	25,000	5	9.5 <i>0.375</i>	8.0 <i>0.315</i>	12.2 <i>0.480</i>	12.7 <i>0.500</i>	64.3 <i>2.531</i>
CP-095095-10-X	10,000	7	9.5 <i>0.375</i>	9.5 <i>0.375</i>	11.1 <i>0.437</i>	12.7 <i>0.500</i>	82.1 <i>3.230</i>
CP-114040-25-X	25,000	6	11.4 <i>0.450</i>	4.0 <i>0.157</i>	11.4 <i>0.450</i>	7.2 <i>0.281</i>	74.6 <i>2.940</i>
CP-127032-10-X	10,000	5	12.7 <i>0.500</i>	3.2 <i>0.125</i>	19.1 <i>0.750</i>	3.2 <i>0.250</i>	94.9 <i>3.736</i>

(continued)

**Product dimensions (continued)**

Product order code	Package quantity	Labels across	Label width (A) mm <i>inches</i>	Label height (B) mm <i>inches</i>	Horizontal repeat (C) mm <i>inches</i>	Vertical repeat (D) mm <i>inches</i>	Web width (E) mm <i>inches</i>
CP-127111-10-X	10,000	5	12.7 <i>0.500</i>	11.1 <i>0.437</i>	16.8 <i>0.662</i>	14.3 <i>0.563</i>	86.0 <i>3.380</i>
CP-127127-10-X	10,000	5	12.7 <i>0.500</i>	12.7 <i>0.500</i>	15.9 <i>0.625</i>	15.9 <i>0.625</i>	82.6 <i>3.250</i>
CP-165051-25-X	25,000	4	16.5 <i>0.650</i>	5.1 <i>0.200</i>	17.8 <i>0.700</i>	8.3 <i>0.325</i>	75.8 <i>2.990</i>
CP-165102-10-X	10,000	5	16.5 <i>0.650</i>	10.2 <i>0.400</i>	19.1 <i>0.750</i>	13.8 <i>0.545</i>	99.1 <i>3.900</i>
CP-171171-10-X	10,000	5	17.1 <i>0.674</i>	17.1 <i>0.674</i>	19.7 <i>0.774</i>	20.3 <i>0.800</i>	101.8 <i>4.006</i>
CP-178095-10-X	10,000	4	17.8 <i>0.700</i>	9.5 <i>0.375</i>	19.1 <i>0.750</i>	12.7 <i>0.500</i>	80.9 <i>3.190</i>
CP-191064-10-X	10,000	4	19.1 <i>0.750</i>	6.4 <i>0.250</i>	21.6 <i>0.850</i>	9.5 <i>0.375</i>	89.9 <i>3.540</i>
CP-191114-15-X	15,000	3	19.1 <i>0.750</i>	11.4 <i>0.450</i>	22.2 <i>0.875</i>	14.7 <i>0.579</i>	69.5 <i>2.736</i>
CP-191762-5-X	5,000	3	19.1 <i>0.750</i>	76.2 <i>3.000</i>	21.6 <i>0.850</i>	88.9 <i>3.500</i>	68.2 <i>2.686</i>
CP-203127-10-X	10,000	4	20.3 <i>0.800</i>	12.7 <i>0.500</i>	22.9 <i>0.900</i>	15.9 <i>0.625</i>	94.6 <i>3.730</i>
CP-208086-5-X	5,000	4	20.8 <i>0.820</i>	8.6 <i>0.340</i>	24.1 <i>0.950</i>	12.7 <i>0.500</i>	101.6 <i>4.000</i>
CP-222159-15-X	15,000	2	22.2 <i>0.875</i>	15.9 <i>0.625</i>	24.8 <i>0.975</i>	19.1 <i>0.750</i>	53.0 <i>2.086</i>
CP-229064-10-X	10,000	3	22.9 <i>0.900</i>	6.4 <i>0.250</i>	28.6 <i>1.125</i>	9.5 <i>0.375</i>	86.0 <i>3.390</i>
CP-250381-10-X	10,000	4	24.9 <i>0.980</i>	38.1 <i>1.500</i>	27.4 <i>1.080</i>	47.6 <i>1.875</i>	113.5 <i>4.470</i>
CP-254045-10-X	10,000	3	25.4 <i>1.000</i>	4.6 <i>0.180</i>	31.8 <i>1.250</i>	8.5 <i>0.333</i>	95.3 <i>3.750</i>
CP-254064-10-X	10,000	3	25.4 <i>1.000</i>	6.4 <i>0.250</i>	27.9 <i>1.100</i>	9.5 <i>0.375</i>	87.3 <i>3.436</i>
CP-254097-10-X	10,000	3	25.4 <i>1.000</i>	9.7 <i>0.380</i>	27.9 <i>1.100</i>	12.7 <i>0.500</i>	87.4 <i>3.440</i>
CP-254127-10-X	10,000	3	25.4 <i>1.000</i>	12.7 <i>0.500</i>	27.9 <i>1.100</i>	16.9 <i>0.666</i>	87.4 <i>3.440</i>
CP-254254-10-X	10,000	3	25.4 <i>1.000</i>	25.4 <i>1.000</i>	27.9 <i>1.100</i>	28.6 <i>1.125</i>	87.4 <i>3.440</i>
CP-305047-10-X	10,000	2	30.5 <i>1.200</i>	4.7 <i>0.185</i>	33.0 <i>1.300</i>	7.8 <i>0.306</i>	69.5 <i>2.736</i>
CP-318064-10-X	10,000	1	31.8 <i>1.250</i>	6.4 <i>0.250</i>	N/A N/A	9.5 <i>0.375</i>	37.9 <i>1.490</i>
CP-318097-10-X	10,000	1	31.8 <i>1.250</i>	9.7 <i>0.380</i>	N/A N/A	12.7 <i>0.500</i>	37.8 <i>1.488</i>
CP-381020-10-X	10,000	1	38.1 <i>1.500</i>	2.0 <i>0.080</i>	N/A N/A	10.7 <i>0.423</i>	44.1 <i>1.740</i>
CP-381064-10-X	10,000	1	38.1 <i>1.500</i>	6.4 <i>0.250</i>	N/A N/A	9.5 <i>0.375</i>	44.5 <i>1.750</i>
CP-381127-5-X	5,000	2	38.1 <i>1.500</i>	12.7 <i>0.500</i>	44.2 <i>1.738</i>	15.9 <i>0.625</i>	88.2 <i>3.472</i>
CP-381191-5-X	5,000	2	38.1 <i>1.500</i>	19.1 <i>0.750</i>	43.2 <i>1.700</i>	22.2 <i>0.875</i>	87.6 <i>3.450</i>
CP-381381-2.5-X	2,500	2	38.1 <i>1.500</i>	38.1 <i>1.500</i>	44.5 <i>1.750</i>	40.8 <i>1.607</i>	88.9 <i>3.500</i>
CP-381635-5-X	5,000	2	38.1 <i>1.500</i>	63.5 <i>2.500</i>	40.6 <i>1.600</i>	66.7 <i>2.625</i>	84.7 <i>3.336</i>
CP-406254-1.5-X	1,500	2	40.6 <i>1.600</i>	25.4 <i>1.000</i>	55.9 <i>2.200</i>	38.1 <i>1.500</i>	102.9 <i>4.050</i>
CP-445064-10-X	10,000	1	44.5 <i>1.750</i>	6.4 <i>0.250</i>	N/A N/A	9.5 <i>0.375</i>	50.4 <i>1.986</i>
CP-445102-5-X	5,000	1	44.5 <i>1.750</i>	10.2 <i>0.400</i>	N/A N/A	12.7 <i>0.500</i>	50.4 <i>1.986</i>
CP-445445-2-X	2,000	1	44.5 <i>1.750</i>	44.5 <i>1.750</i>	N/A N/A	47.6 <i>1.875</i>	50.4 <i>1.986</i>
CP-478175-5-X	5,000	1	47.8 <i>1.880</i>	17.5 <i>0.690</i>	N/A N/A	24.4 <i>0.962</i>	66.0 <i>2.600</i>
CP-508064-10-X	10,000	1	50.8 <i>2.000</i>	6.4 <i>0.250</i>	N/A N/A	9.5 <i>0.375</i>	56.9 <i>2.240</i>
CP-508095-5-X	5,000	1	50.8 <i>2.000</i>	9.5 <i>0.375</i>	N/A N/A	12.7 <i>0.500</i>	57.2 <i>2.250</i>
CP-508127-10-X	10,000	1	50.8 <i>2.000</i>	12.7 <i>0.500</i>	N/A N/A	15.9 <i>0.625</i>	56.9 <i>2.240</i>
CP-508254-5-X	5,000	1	50.8 <i>2.000</i>	25.4 <i>1.000</i>	N/A N/A	28.6 <i>1.125</i>	57.2 <i>2.250</i>
CP-508318-2.5-X	2,500	1	50.8 <i>2.000</i>	31.8 <i>1.250</i>	N/A N/A	34.9 <i>1.375</i>	56.9 <i>2.240</i>
CP-508508-3-X	3,000	1	50.8 <i>2.000</i>	50.8 <i>2.000</i>	N/A N/A	54.6 <i>2.150</i>	54.0 <i>2.130</i>
CP-523841-1.5-X	1,500	1	52.3 <i>2.060</i>	84.1 <i>3.310</i>	N/A N/A	88.9 <i>3.500</i>	58.2 <i>2.290</i>
CP-610419-2.5-X	2,500	1	61.0 <i>2.400</i>	41.9 <i>1.650</i>	N/A N/A	45.5 <i>1.792</i>	67.3 <i>2.650</i>
CP-699191-5-X	5,000	1	69.9 <i>2.750</i>	19.1 <i>0.750</i>	N/A N/A	23.3 <i>0.917</i>	76.2 <i>3.000</i>
CP-699254-5-X	5,000	1	69.9 <i>2.750</i>	25.4 <i>1.000</i>	N/A N/A	28.6 <i>1.125</i>	76.2 <i>3.000</i>
CP-762381-2.5-X	2,500	1	76.2 <i>3.000</i>	38.1 <i>1.500</i>	N/A N/A	41.3 <i>1.625</i>	82.3 <i>3.240</i>
CP-762508-2.5-X	2,500	1	76.2 <i>3.000</i>	50.8 <i>2.000</i>	N/A N/A	54.0 <i>2.125</i>	82.6 <i>3.240</i>
CP-762127-1-X	1,000	1	76.2 <i>3.000</i>	127.0 <i>5.000</i>	N/A N/A	129.5 <i>5.100</i>	79.4 <i>3.130</i>
CP-101508-2.5-X	2,500	1	101.6 <i>4.000</i>	50.8 <i>2.000</i>	N/A N/A	54.6 <i>2.150</i>	104.1 <i>4.100</i>
CP-101635-2.5-X	2,500	1	101.6 <i>4.000</i>	63.5 <i>2.500</i>	N/A N/A	66.7 <i>2.625</i>	107.7 <i>4.240</i>
CP-101762-1.8-X	1,800	1	101.6 <i>4.000</i>	76.2 <i>3.000</i>	N/A N/A	79.4 <i>3.125</i>	104.1 <i>4.100</i>
CP-101101-1.3-X	1,300	1	101.6 <i>4.000</i>	101.6 <i>4.000</i>	N/A N/A	104.8 <i>4.125</i>	104.1 <i>4.100</i>
CP-101165-0.85-X	850	1	101.6 <i>4.000</i>	165.1 <i>6.500</i>	N/A N/A	168.3 <i>6.680</i>	104.9 <i>4.130</i>



Electronics

Thermal Transfer

HW High tack white polyester labels

Tyco HW is a thermal transfer printable white polyester film with a high tack permanent acrylic adhesive. Designed for application to rough surfaces or where increased adhesion is required, HW is also excellent for bar-coding, electronic PCB, component and general labeling applications. The high tack adhesion of HW will bond to the most demanding surfaces, including textured and contoured surfaces. For guaranteed print performance and durability, use with Tyco's RHD series ribbon.



Features and benefits

- Thermal transfer printable.
- Aggressive adhesive for textured and powdered surfaces.
- UL Listed and CSA Certified.



<b>Adhesive</b>	Permanent acrylic	
<b>Service temperature</b>	-40°C to +150°C	-40°F to +302°F
<b>Recommended printer</b>	T308S*	
<b>Recommended ribbon</b>	1330-0607-10*	
	<i>*Alternative printers and ribbons are available for special applications. Contact Tyco Electronics Identification for more information.</i>	

Part numbering system

HW-044033-10-9



Ordering information



Product dimensions

Product order code	Package quantity	Labels across	Label width (A)		Label height (B)		Horizontal repeat (C)		Vertical repeat (D)		Web width (E)	
			mm	<i>inches</i>	mm	<i>inches</i>	mm	<i>inches</i>	mm	<i>inches</i>	mm	<i>inches</i>
HW-040040-25-9	25,000	20	4.0	<i>0.157</i>	4.0	<i>0.157</i>	4.0	<i>0.157</i>	7.2	<i>0.281</i>	86.0	<i>3.380</i>
HW-044033-10-9	10,000	20	4.4	<i>0.170</i>	3.3	<i>0.130</i>	4.4	<i>0.170</i>	9.5	<i>0.375</i>	92.4	<i>3.636</i>
HW-064064-25-9	25,000	12	6.4	<i>0.250</i>	6.4	<i>0.250</i>	6.4	<i>0.250</i>	9.5	<i>0.375</i>	82.2	<i>3.240</i>
HW-080080-10-9	10,000	8	8.0	<i>0.315</i>	8.0	<i>0.315</i>	9.9	<i>0.390</i>	13.3	<i>0.525</i>	83.3	<i>3.280</i>
HW-089047-10-9	10,000	5	8.9	<i>0.350</i>	4.7	<i>0.186</i>	11.4	<i>0.450</i>	7.9	<i>0.313</i>	60.6	<i>2.386</i>
HW-095080-25-9	25,000	5	9.5	<i>0.375</i>	8.0	<i>0.315</i>	12.2	<i>0.480</i>	12.7	<i>0.500</i>	64.3	<i>2.531</i>
HW-095095-10-9	10,000	7	9.5	<i>0.375</i>	9.5	<i>0.375</i>	11.1	<i>0.437</i>	12.7	<i>0.500</i>	82.1	<i>3.230</i>
HW-114040-25-9	25,000	6	11.4	<i>0.450</i>	4.0	<i>0.157</i>	11.4	<i>0.450</i>	7.2	<i>0.281</i>	74.6	<i>2.940</i>
HW-127032-10-9	10,000	5	12.7	<i>0.500</i>	3.2	<i>0.125</i>	19.1	<i>0.750</i>	3.2	<i>0.250</i>	94.9	<i>3.736</i>

(continued)

**Product dimensions (continued)**

Product order code	Package quantity	Labels across	Label width (A) mm <i>inches</i>	Label height (B) mm <i>inches</i>	Horizontal repeat (C) mm <i>inches</i>	Vertical repeat (D) mm <i>inches</i>	Web width (E) mm <i>inches</i>
HW-127111-10-9	10,000	5	12.7 <i>0.500</i>	11.1 <i>0.437</i>	16.8 <i>0.662</i>	14.3 <i>0.563</i>	86.0 <i>3.380</i>
HW-127127-10-9	10,000	5	12.7 <i>0.500</i>	12.7 <i>0.500</i>	15.9 <i>0.625</i>	15.9 <i>0.625</i>	82.6 <i>3.250</i>
HW-165051-25-9	25,000	4	16.5 <i>0.650</i>	5.1 <i>0.200</i>	17.8 <i>0.700</i>	8.3 <i>0.325</i>	75.8 <i>2.990</i>
HW-165102-10-9	10,000	5	16.5 <i>0.650</i>	10.2 <i>0.400</i>	19.1 <i>0.750</i>	13.8 <i>0.545</i>	99.1 <i>3.900</i>
HW-171171-10-9	10,000	5	17.1 <i>0.674</i>	17.1 <i>0.674</i>	19.7 <i>0.774</i>	20.3 <i>0.800</i>	101.8 <i>4.006</i>
HW-178095-10-9	10,000	4	17.8 <i>0.700</i>	9.5 <i>0.375</i>	19.1 <i>0.750</i>	12.7 <i>0.500</i>	80.9 <i>3.190</i>
HW-191064-10-9	10,000	4	19.1 <i>0.750</i>	6.4 <i>0.250</i>	21.6 <i>0.850</i>	9.5 <i>0.375</i>	89.9 <i>3.540</i>
HW-191114-15-9	15,000	3	19.1 <i>0.750</i>	11.4 <i>0.450</i>	22.2 <i>0.875</i>	14.7 <i>0.579</i>	69.5 <i>2.736</i>
HW-191762-5-9	5,000	3	19.1 <i>0.750</i>	76.2 <i>3.000</i>	21.6 <i>0.850</i>	88.9 <i>3.500</i>	68.2 <i>2.688</i>
HW-203127-10-9	10,000	4	20.3 <i>0.800</i>	12.7 <i>0.500</i>	22.9 <i>0.900</i>	15.9 <i>0.625</i>	94.6 <i>3.730</i>
HW-208086-5-9	5,000	4	20.8 <i>0.820</i>	8.6 <i>0.340</i>	24.1 <i>0.950</i>	12.7 <i>0.500</i>	101.6 <i>4.000</i>
HW-222159-15-9	15,000	2	22.2 <i>0.875</i>	15.9 <i>0.625</i>	24.8 <i>0.975</i>	19.1 <i>0.750</i>	53.0 <i>2.086</i>
HW-229064-10-9	10,000	3	22.9 <i>0.900</i>	6.4 <i>0.250</i>	28.6 <i>1.125</i>	9.5 <i>0.375</i>	86.0 <i>3.390</i>
HW-250381-10-9	10,000	4	24.9 <i>0.980</i>	38.1 <i>1.500</i>	27.4 <i>1.080</i>	47.6 <i>1.875</i>	113.5 <i>4.470</i>
HW-254045-10-9	10,000	3	25.4 <i>1.000</i>	4.6 <i>0.180</i>	31.8 <i>1.250</i>	8.5 <i>0.333</i>	95.3 <i>3.750</i>
HW-254064-10-9	10,000	3	25.4 <i>1.000</i>	6.4 <i>0.250</i>	27.9 <i>1.100</i>	9.5 <i>0.375</i>	87.3 <i>3.436</i>
HW-254097-10-9	10,000	3	25.4 <i>1.000</i>	9.7 <i>0.380</i>	27.9 <i>1.100</i>	12.7 <i>0.500</i>	87.4 <i>3.440</i>
HW-254127-10-9	10,000	3	25.4 <i>1.000</i>	12.7 <i>0.500</i>	27.9 <i>1.100</i>	16.9 <i>0.666</i>	87.4 <i>3.440</i>
HW-254254-10-9	10,000	3	25.4 <i>1.000</i>	25.4 <i>1.000</i>	27.9 <i>1.100</i>	28.6 <i>1.125</i>	87.4 <i>3.440</i>
HW-305047-10-9	10,000	2	30.5 <i>1.200</i>	4.7 <i>0.185</i>	33.0 <i>1.300</i>	7.8 <i>0.306</i>	69.5 <i>2.736</i>
HW-318064-10-9	10,000	1	31.8 <i>1.250</i>	6.4 <i>0.250</i>	N/A <i>N/A</i>	9.5 <i>0.375</i>	37.9 <i>1.490</i>
HW-318097-10-9	10,000	1	31.8 <i>1.250</i>	9.7 <i>0.380</i>	N/A <i>N/A</i>	12.7 <i>0.500</i>	37.8 <i>1.488</i>
HW-381020-10-9	10,000	1	38.1 <i>1.500</i>	2.0 <i>0.080</i>	N/A <i>N/A</i>	10.7 <i>0.423</i>	44.1 <i>1.740</i>
HW-381064-10-9	10,000	1	38.1 <i>1.500</i>	6.4 <i>0.250</i>	N/A <i>N/A</i>	9.5 <i>0.375</i>	44.5 <i>1.750</i>
HW-381127-5-9	5,000	2	38.1 <i>1.500</i>	12.7 <i>0.500</i>	44.2 <i>1.738</i>	15.9 <i>0.625</i>	88.2 <i>3.472</i>
HW-381191-5-9	5,000	2	38.1 <i>1.500</i>	19.1 <i>0.750</i>	43.2 <i>1.700</i>	22.2 <i>0.875</i>	87.6 <i>3.450</i>
HW-381381-2.5-9	2,500	2	38.1 <i>1.500</i>	38.1 <i>1.500</i>	44.5 <i>1.750</i>	40.8 <i>1.607</i>	88.9 <i>3.500</i>
HW-381635-5-9	5,000	2	38.1 <i>1.500</i>	63.5 <i>2.500</i>	40.6 <i>1.600</i>	66.7 <i>2.625</i>	84.7 <i>3.338</i>
HW-406254-1.5-9	1,500	2	40.6 <i>1.600</i>	25.4 <i>1.000</i>	55.9 <i>2.200</i>	38.1 <i>1.500</i>	102.9 <i>4.050</i>
HW-445064-10-9	10,000	1	44.5 <i>1.750</i>	6.4 <i>0.250</i>	N/A <i>N/A</i>	9.5 <i>0.375</i>	50.4 <i>1.986</i>
HW-445102-5-9	5,000	1	44.5 <i>1.750</i>	10.2 <i>0.400</i>	N/A <i>N/A</i>	12.7 <i>0.500</i>	50.4 <i>1.986</i>
HW-445445-2-9	2,000	1	44.5 <i>1.750</i>	44.5 <i>1.750</i>	N/A <i>N/A</i>	47.6 <i>1.875</i>	50.4 <i>1.986</i>
HW-478175-5-9	5,000	1	47.8 <i>1.880</i>	17.5 <i>0.690</i>	N/A <i>N/A</i>	24.4 <i>0.962</i>	66.0 <i>2.600</i>
HW-508064-10-9	10,000	1	50.8 <i>2.000</i>	6.4 <i>0.250</i>	N/A <i>N/A</i>	9.5 <i>0.375</i>	56.9 <i>2.240</i>
HW-508095-5-9	5,000	1	50.8 <i>2.000</i>	9.5 <i>0.375</i>	N/A <i>N/A</i>	12.7 <i>0.500</i>	57.2 <i>2.250</i>
HW-508127-10-9	10,000	1	50.8 <i>2.000</i>	12.7 <i>0.500</i>	N/A <i>N/A</i>	15.9 <i>0.625</i>	56.9 <i>2.240</i>
HW-508254-5-9	5,000	1	50.8 <i>2.000</i>	25.4 <i>1.000</i>	N/A <i>N/A</i>	28.6 <i>1.125</i>	57.2 <i>2.250</i>
HW-508318-2.5-9	2,500	1	50.8 <i>2.000</i>	31.8 <i>1.250</i>	N/A <i>N/A</i>	34.9 <i>1.375</i>	56.9 <i>2.240</i>
HW-508508-3-9	3,000	1	50.8 <i>2.000</i>	50.8 <i>2.000</i>	N/A <i>N/A</i>	54.6 <i>2.150</i>	54.0 <i>2.130</i>
HW-523841-1.5-9	1,500	1	52.3 <i>2.060</i>	84.1 <i>3.310</i>	N/A <i>N/A</i>	88.9 <i>3.500</i>	58.2 <i>2.290</i>
HW-610419-2.5-9	2,500	1	61.0 <i>2.400</i>	41.9 <i>1.650</i>	N/A <i>N/A</i>	45.5 <i>1.792</i>	67.3 <i>2.650</i>
HW-699191-5-9	5,000	1	69.9 <i>2.750</i>	19.1 <i>0.750</i>	N/A <i>N/A</i>	23.3 <i>0.917</i>	76.2 <i>3.000</i>
HW-699254-5-9	5,000	1	69.9 <i>2.750</i>	25.4 <i>1.000</i>	N/A <i>N/A</i>	28.6 <i>1.125</i>	76.2 <i>3.000</i>
HW-762381-2.5-9	2,500	1	76.2 <i>3.000</i>	38.1 <i>1.500</i>	N/A <i>N/A</i>	41.3 <i>1.625</i>	82.3 <i>3.240</i>
HW-762508-2.5-9	2,500	1	76.2 <i>3.000</i>	50.8 <i>2.000</i>	N/A <i>N/A</i>	54.0 <i>2.125</i>	82.6 <i>3.240</i>
HW-762127-1-9	1,000	1	76.2 <i>3.000</i>	127.0 <i>5.000</i>	N/A <i>N/A</i>	129.5 <i>5.100</i>	79.4 <i>3.130</i>
HW-101508-2.5-9	2,500	1	101.6 <i>4.000</i>	50.8 <i>2.000</i>	N/A <i>N/A</i>	54.6 <i>2.150</i>	104.1 <i>4.100</i>
HW-101635-2.5-9	2,500	1	101.6 <i>4.000</i>	63.5 <i>2.500</i>	N/A <i>N/A</i>	66.7 <i>2.625</i>	107.7 <i>4.240</i>
HW-101762-1.8-9	1,800	1	101.6 <i>4.000</i>	76.2 <i>3.000</i>	N/A <i>N/A</i>	79.4 <i>3.125</i>	104.1 <i>4.100</i>
HW-101101-1.3-9	1,300	1	101.6 <i>4.000</i>	101.6 <i>4.000</i>	N/A <i>N/A</i>	104.8 <i>4.125</i>	104.1 <i>4.100</i>
HW-101165-0.85-9	850	1	101.6 <i>4.000</i>	165.1 <i>6.500</i>	N/A <i>N/A</i>	168.3 <i>6.680</i>	104.9 <i>4.130</i>

**HM High tack metalized polyester labels**

Tyco HM is a thermal transfer printable metalized polyester film with a high tack permanent acrylic adhesive, designed for application to rough surfaces or where increased adhesion is required, and applications that require a metal look such as rating plates. The high tack adhesion of HM will bond to the most demanding surfaces, including textured and contoured surfaces. For guaranteed print performance and durability, use with Tyco's RHD series ribbon.



**Features and benefits**

- Thermal transfer printable.
- Aggressive adhesive which permanently bonds to both high and low surface energy plastics.
- UL Listed and CSA Certified.



<b>Adhesive</b>	Permanent acrylic
<b>Service temperature</b>	-40°C to +150°C    -40°F to +302°F
<b>Recommended printer</b>	T308S*
<b>Recommended ribbon</b>	1330-0607-10*
<small>*Alternative printers and ribbons are available for special applications. Contact Tyco Electronics Identification for more information.</small>	

**Part numbering system**

**HM-044033-10-8A**



**Ordering information**



**Product dimensions**

Product order code	Package quantity	Labels across	Label width (A) mm    inches	Label height (B) mm    inches	Horizontal repeat (C) mm    inches	Vertical repeat (D) mm    inches	Web width (E) mm    inches
HM-040040-25-8A	25,000	20	4.0    0.157	4.0    0.157	4.0    0.157	7.2    0.281	86.0    3.380
HM-044033-10-8A	10,000	20	4.4    0.170	3.3    0.130	4.4    0.170	9.5    0.375	92.4    3.636
HM-064064-25-8A	25,000	12	6.4    0.250	6.4    0.250	6.4    0.250	9.5    0.375	82.2    3.240
HM-080080-10-8A	10,000	8	8.0    0.315	8.0    0.315	9.9    0.390	13.3    0.525	83.3    3.280
HM-089047-10-8A	10,000	5	8.9    0.350	4.7    0.185	11.4    0.450	7.9    0.313	60.6    2.386
HM-095080-25-8A	25,000	5	9.5    0.375	8.0    0.315	12.2    0.480	12.7    0.500	64.3    2.531
HM-095095-10-8A	10,000	7	9.5    0.375	9.5    0.375	11.1    0.437	12.7    0.500	82.1    3.230
HM-114040-25-8A	25,000	6	11.4    0.450	4.0    0.157	11.4    0.450	7.2    0.281	74.6    2.940
HM-127032-10-8A	10,000	5	12.7    0.500	3.2    0.125	19.1    0.750	3.2    0.250	94.9    3.736

(continued)



**Product dimensions (continued)**

Product order code	Package quantity	Labels across	Label width (A)		Label height (B)		Horizontal repeat (C)		Vertical repeat (D)		Web width (E)	
			mm	<i>inches</i>	mm	<i>inches</i>	mm	<i>inches</i>	mm	<i>inches</i>	mm	<i>inches</i>
HM-127111-10-8A	10,000	5	12.7	<i>0.500</i>	11.1	<i>0.437</i>	16.8	<i>0.662</i>	14.3	<i>0.563</i>	86.0	<i>3.380</i>
HM-127127-10-8A	10,000	5	12.7	<i>0.500</i>	12.7	<i>0.500</i>	15.9	<i>0.625</i>	15.9	<i>0.625</i>	82.6	<i>3.250</i>
HM-165051-25-8A	25,000	4	16.5	<i>0.650</i>	5.1	<i>0.200</i>	17.8	<i>0.700</i>	8.3	<i>0.325</i>	75.8	<i>2.990</i>
HM-165102-10-8A	10,000	5	16.5	<i>0.650</i>	10.2	<i>0.400</i>	19.1	<i>0.750</i>	13.8	<i>0.545</i>	99.1	<i>3.900</i>
HM-171171-10-8A	10,000	5	17.1	<i>0.674</i>	17.1	<i>0.674</i>	19.7	<i>0.774</i>	20.3	<i>0.800</i>	101.8	<i>4.006</i>
HM-178095-10-8A	10,000	4	17.8	<i>0.700</i>	9.5	<i>0.375</i>	19.1	<i>0.750</i>	12.7	<i>0.500</i>	80.9	<i>3.190</i>
HM-191064-10-8A	10,000	4	19.1	<i>0.750</i>	6.4	<i>0.250</i>	21.6	<i>0.850</i>	9.5	<i>0.375</i>	89.9	<i>3.540</i>
HM-191114-15-8A	15,000	3	19.1	<i>0.750</i>	11.4	<i>0.450</i>	22.2	<i>0.875</i>	14.7	<i>0.579</i>	69.5	<i>2.736</i>
HM-191762-5-8A	5,000	3	19.1	<i>0.750</i>	76.2	<i>3.000</i>	21.6	<i>0.850</i>	88.9	<i>3.500</i>	68.2	<i>2.686</i>
HM-203127-10-8A	10,000	4	20.3	<i>0.800</i>	12.7	<i>0.500</i>	22.9	<i>0.900</i>	15.9	<i>0.625</i>	94.6	<i>3.730</i>
HM-208086-5-8A	5,000	4	20.8	<i>0.820</i>	8.6	<i>0.340</i>	24.1	<i>0.950</i>	12.7	<i>0.500</i>	101.6	<i>4.000</i>
HM-222159-15-8A	15,000	2	22.2	<i>0.875</i>	15.9	<i>0.625</i>	24.8	<i>0.975</i>	19.1	<i>0.750</i>	53.0	<i>2.086</i>
HM-229064-10-8A	10,000	3	22.9	<i>0.900</i>	6.4	<i>0.250</i>	28.6	<i>1.125</i>	9.5	<i>0.375</i>	86.0	<i>3.390</i>
HM-250381-10-8A	10,000	4	24.9	<i>0.980</i>	38.1	<i>1.500</i>	27.4	<i>1.080</i>	47.6	<i>1.875</i>	113.5	<i>4.470</i>
HM-254045-10-8A	10,000	3	25.4	<i>1.000</i>	4.6	<i>0.180</i>	31.8	<i>1.250</i>	8.5	<i>0.333</i>	95.3	<i>3.750</i>
HM-254064-10-8A	10,000	3	25.4	<i>1.000</i>	6.4	<i>0.250</i>	27.9	<i>1.100</i>	9.5	<i>0.375</i>	87.3	<i>3.436</i>
HM-254097-10-8A	10,000	3	25.4	<i>1.000</i>	9.7	<i>0.380</i>	27.9	<i>1.100</i>	12.7	<i>0.500</i>	87.4	<i>3.440</i>
HM-254127-10-8A	10,000	3	25.4	<i>1.000</i>	12.7	<i>0.500</i>	27.9	<i>1.100</i>	16.9	<i>0.666</i>	87.4	<i>3.440</i>
HM-254254-10-8A	10,000	3	25.4	<i>1.000</i>	25.4	<i>1.000</i>	27.9	<i>1.100</i>	28.6	<i>1.125</i>	87.4	<i>3.440</i>
HM-305047-10-8A	10,000	2	30.5	<i>1.200</i>	4.7	<i>0.185</i>	33.0	<i>1.300</i>	7.8	<i>0.306</i>	69.5	<i>2.736</i>
HM-318064-10-8A	10,000	1	31.8	<i>1.250</i>	6.4	<i>0.250</i>	N/A	N/A	9.5	<i>0.375</i>	37.9	<i>1.490</i>
HM-318097-10-8A	10,000	1	31.8	<i>1.250</i>	9.7	<i>0.380</i>	N/A	N/A	12.7	<i>0.500</i>	37.8	<i>1.488</i>
HM-381020-10-8A	10,000	1	38.1	<i>1.500</i>	2.0	<i>0.080</i>	N/A	N/A	10.7	<i>0.423</i>	44.1	<i>1.740</i>
HM-381064-10-8A	10,000	1	38.1	<i>1.500</i>	6.4	<i>0.250</i>	N/A	N/A	9.5	<i>0.375</i>	44.5	<i>1.750</i>
HM-381127-5-8A	5,000	2	38.1	<i>1.500</i>	12.7	<i>0.500</i>	44.2	<i>1.738</i>	15.9	<i>0.625</i>	88.2	<i>3.472</i>
HM-381191-5-8A	5,000	2	38.1	<i>1.500</i>	19.1	<i>0.750</i>	43.2	<i>1.700</i>	22.2	<i>0.875</i>	87.6	<i>3.450</i>
HM-381381-2.5-8A	2,500	2	38.1	<i>1.500</i>	38.1	<i>1.500</i>	44.5	<i>1.750</i>	40.8	<i>1.607</i>	88.9	<i>3.500</i>
HM-381635-5-8A	5,000	2	38.1	<i>1.500</i>	63.5	<i>2.500</i>	40.6	<i>1.600</i>	66.7	<i>2.625</i>	84.7	<i>3.336</i>
HM-406254-1.5-8A	1,500	2	40.6	<i>1.600</i>	25.4	<i>1.000</i>	55.9	<i>2.200</i>	38.1	<i>1.500</i>	102.9	<i>4.050</i>
HM-445064-10-8A	10,000	1	44.5	<i>1.750</i>	6.4	<i>0.250</i>	N/A	N/A	9.5	<i>0.375</i>	50.4	<i>1.986</i>
HM-445102-5-8A	5,000	1	44.5	<i>1.750</i>	10.2	<i>0.400</i>	N/A	N/A	12.7	<i>0.500</i>	50.4	<i>1.986</i>
HM-445445-2-8A	2,000	1	44.5	<i>1.750</i>	44.5	<i>1.750</i>	N/A	N/A	47.6	<i>1.875</i>	50.4	<i>1.986</i>
HM-478175-5-8A	5,000	1	47.8	<i>1.880</i>	17.5	<i>0.690</i>	N/A	N/A	24.4	<i>0.962</i>	66.0	<i>2.600</i>
HM-508064-10-8A	10,000	1	50.8	<i>2.000</i>	6.4	<i>0.250</i>	N/A	N/A	9.5	<i>0.375</i>	56.9	<i>2.240</i>
HM-508095-5-8A	5,000	1	50.8	<i>2.000</i>	9.5	<i>0.375</i>	N/A	N/A	12.7	<i>0.500</i>	57.2	<i>2.250</i>
HM-508127-10-8A	10,000	1	50.8	<i>2.000</i>	12.7	<i>0.500</i>	N/A	N/A	15.9	<i>0.625</i>	56.9	<i>2.240</i>
HM-508254-5-8A	5,000	1	50.8	<i>2.000</i>	25.4	<i>1.000</i>	N/A	N/A	28.6	<i>1.125</i>	57.2	<i>2.250</i>
HM-508318-2.5-8A	2,500	1	50.8	<i>2.000</i>	31.8	<i>1.250</i>	N/A	N/A	34.9	<i>1.375</i>	56.9	<i>2.240</i>
HM-508508-3-8A	3,000	1	50.8	<i>2.000</i>	50.8	<i>2.000</i>	N/A	N/A	54.6	<i>2.150</i>	54.0	<i>2.130</i>
HM-523841-1.5-8A	1,500	1	52.3	<i>2.060</i>	84.1	<i>3.310</i>	N/A	N/A	88.9	<i>3.500</i>	58.2	<i>2.290</i>
HM-610419-2.5-8A	2,500	1	61.0	<i>2.400</i>	41.9	<i>1.650</i>	N/A	N/A	45.5	<i>1.792</i>	67.3	<i>2.650</i>
HM-699191-5-8A	5,000	1	69.9	<i>2.750</i>	19.1	<i>0.750</i>	N/A	N/A	23.3	<i>0.917</i>	76.2	<i>3.000</i>
HM-699254-5-8A	5,000	1	69.9	<i>2.750</i>	25.4	<i>1.000</i>	N/A	N/A	28.6	<i>1.125</i>	76.2	<i>3.000</i>
HM-762381-2.5-8A	2,500	1	76.2	<i>3.000</i>	38.1	<i>1.500</i>	N/A	N/A	41.3	<i>1.625</i>	82.3	<i>3.240</i>
HM-762508-2.5-8A	2,500	1	76.2	<i>3.000</i>	50.8	<i>2.000</i>	N/A	N/A	54.0	<i>2.125</i>	82.6	<i>3.240</i>
HM-762127-1-8A	1,000	1	76.2	<i>3.000</i>	127.0	<i>5.000</i>	N/A	N/A	129.5	<i>5.100</i>	79.4	<i>3.130</i>
HM-101508-2.5-8A	2,500	1	101.6	<i>4.000</i>	50.8	<i>2.000</i>	N/A	N/A	54.6	<i>2.150</i>	104.1	<i>4.100</i>
HM-101635-2.5-8A	2,500	1	101.6	<i>4.000</i>	63.5	<i>2.500</i>	N/A	N/A	66.7	<i>2.625</i>	107.7	<i>4.240</i>
HM-101762-1.8-8A	1,800	1	101.6	<i>4.000</i>	76.2	<i>3.000</i>	N/A	N/A	79.4	<i>3.125</i>	104.1	<i>4.100</i>
HM-101101-1.3-8A	1,300	1	101.6	<i>4.000</i>	101.6	<i>4.000</i>	N/A	N/A	104.8	<i>4.125</i>	104.1	<i>4.100</i>
HM-101165-0.85-8A	850	1	101.6	<i>4.000</i>	165.1	<i>6.500</i>	N/A	N/A	168.3	<i>6.680</i>	104.9	<i>4.130</i>

**MP Metalized polyester labels**

Tyco MP is a thermal transfer printable metalized polyester film with a permanent acrylic adhesive, designed for rating plates and other applications that require a metal look, such as nameplates, equipment labels, detailed product information labels and serial number plates. MP is UL Listed and CSA Certified. Print performance and durability are guaranteed when used with Tyco's RHD series ribbon.

**Features and benefits**

- Thermal transfer printable.
- Metalized appearance.
- Ideal for rating plate applications.
- Several die-cut sizes available.
- UL Listed and CSA Certified.



<b>Adhesive</b>	Permanent acrylic	
<b>Service temperature</b>	-40°C to +150°F	-40°F to +302°F
<b>Recommended printer</b>	T308S*	
<b>Recommended ribbon</b>	1330-0607-10*	
	<i>*Alternative printers and ribbons are available for special applications. Contact Tyco Electronics Identification for more information.</i>	



**Part numbering system**

MP-044033-10-8A

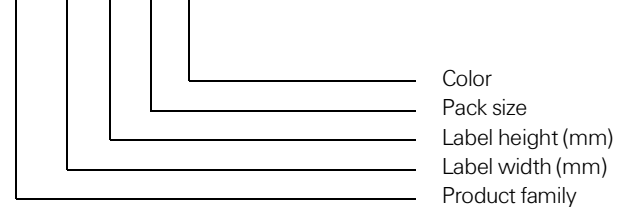

**Ordering information**

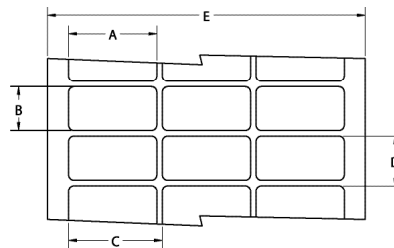

**Product dimensions**

Product order code	Package quantity	Labels across	Label width (A)		Label height (B)		Horizontal repeat (C)		Vertical repeat (D)		Web width (E)	
			mm	<i>inches</i>	mm	<i>inches</i>	mm	<i>inches</i>	mm	<i>inches</i>	mm	<i>inches</i>
MP-040040-25-8A	25,000	20	4.0	<i>0.157</i>	4.0	<i>0.160</i>	4.0	<i>0.157</i>	7.2	<i>0.281</i>	86.0	<i>3.380</i>
MP-044033-10-8A	10,000	20	4.4	<i>0.170</i>	3.3	<i>0.130</i>	4.4	<i>0.170</i>	9.5	<i>0.375</i>	92.4	<i>3.636</i>
MP-064064-25-8A	25,000	12	6.4	<i>0.250</i>	6.4	<i>0.250</i>	6.4	<i>0.250</i>	9.5	<i>0.375</i>	82.2	<i>3.240</i>
MP-080080-10-8A	10,000	8	8.0	<i>0.315</i>	8.0	<i>0.315</i>	9.9	<i>0.390</i>	13.3	<i>0.525</i>	83.3	<i>3.280</i>
MP-089047-10-8A	10,000	5	8.9	<i>0.350</i>	4.7	<i>0.185</i>	11.4	<i>0.450</i>	7.9	<i>0.313</i>	60.6	<i>2.386</i>
MP-095080-25-8A	25,000	5	9.5	<i>0.375</i>	8.0	<i>0.315</i>	12.2	<i>0.475</i>	12.7	<i>0.500</i>	64.3	<i>2.531</i>
MP-095095-10-8A	10,000	7	9.5	<i>0.375</i>	9.5	<i>0.375</i>	11.1	<i>0.437</i>	12.7	<i>0.500</i>	82.1	<i>3.230</i>
MP-114040-25-8A	25,000	6	11.4	<i>0.450</i>	4.0	<i>0.157</i>	11.4	<i>0.450</i>	7.2	<i>0.281</i>	74.6	<i>2.940</i>
MP-127032-10-8A	10,000	5	12.7	<i>0.500</i>	3.2	<i>0.125</i>	19.1	<i>0.750</i>	3.2	<i>0.250</i>	94.9	<i>3.736</i>

(continued)

**Product dimensions (continued)**

Product order code	Package quantity	Labels across	Label width (A)		Label height (B)		Horizontal repeat (C)		Vertical repeat (D)		Web width (E)	
			mm	<i>inches</i>	mm	<i>inches</i>	mm	<i>inches</i>	mm	<i>inches</i>	mm	<i>inches</i>
MP-127111-10-8A	10,000	5	12.7	<i>0.500</i>	11.1	<i>0.437</i>	16.8	<i>0.662</i>	14.3	<i>0.563</i>	86.0	<i>3.380</i>
MP-127127-10-8A	10,000	5	12.7	<i>0.500</i>	12.7	<i>0.500</i>	15.9	<i>0.625</i>	15.9	<i>0.625</i>	82.6	<i>3.250</i>
MP-165051-25-8A	25,000	4	16.5	<i>0.650</i>	5.1	<i>0.200</i>	17.8	<i>0.700</i>	8.3	<i>0.325</i>	75.8	<i>2.990</i>
MP-165102-10-8A	10,000	5	16.5	<i>0.650</i>	10.2	<i>0.400</i>	19.1	<i>0.750</i>	13.8	<i>0.545</i>	99.1	<i>3.900</i>
MP-171171-10-8A	10,000	5	17.1	<i>0.674</i>	17.1	<i>0.674</i>	19.7	<i>0.774</i>	20.3	<i>0.800</i>	101.8	<i>4.006</i>
MP-178095-10-8A	10,000	4	17.8	<i>0.700</i>	9.5	<i>0.375</i>	19.1	<i>0.750</i>	12.7	<i>0.500</i>	80.9	<i>3.190</i>
MP-191064-10-8A	10,000	4	19.1	<i>0.750</i>	6.4	<i>0.250</i>	21.6	<i>0.850</i>	9.5	<i>0.375</i>	89.9	<i>3.540</i>
MP-191114-15-8A	15,000	3	19.1	<i>0.750</i>	11.4	<i>0.450</i>	22.2	<i>0.875</i>	14.7	<i>0.579</i>	69.5	<i>2.736</i>
MP-191762-5-8A	5,000	3	19.1	<i>0.750</i>	76.2	<i>3.000</i>	21.6	<i>0.850</i>	88.9	<i>3.500</i>	68.2	<i>2.686</i>
MP-203127-10-8A	10,000	4	20.3	<i>0.800</i>	12.7	<i>0.500</i>	22.9	<i>0.900</i>	15.9	<i>0.625</i>	94.6	<i>3.730</i>
MP-208086-5-8A	5,000	4	20.8	<i>0.820</i>	8.6	<i>0.340</i>	24.1	<i>0.950</i>	12.7	<i>0.500</i>	101.6	<i>4.000</i>
MP-222159-15-8A	15,000	2	22.2	<i>0.875</i>	15.9	<i>0.625</i>	24.8	<i>0.975</i>	19.1	<i>0.750</i>	53.0	<i>2.086</i>
MP-229064-10-8A	10,000	3	22.9	<i>0.900</i>	6.4	<i>0.250</i>	28.6	<i>1.125</i>	9.5	<i>0.375</i>	86.0	<i>3.390</i>
MP-250381-10-8A	10,000	4	24.9	<i>0.980</i>	38.1	<i>1.500</i>	27.4	<i>1.080</i>	47.6	<i>1.875</i>	113.5	<i>4.470</i>
MP-254045-10-8A	10,000	3	25.4	<i>1.000</i>	4.6	<i>0.180</i>	31.8	<i>1.250</i>	8.5	<i>0.333</i>	95.3	<i>3.750</i>
MP-254064-10-8A	10,000	3	25.4	<i>1.000</i>	6.4	<i>0.250</i>	27.9	<i>1.100</i>	9.5	<i>0.375</i>	87.3	<i>3.436</i>
MP-254097-10-8A	10,000	3	25.4	<i>1.000</i>	9.7	<i>0.380</i>	27.9	<i>1.100</i>	12.7	<i>0.500</i>	87.4	<i>3.440</i>
MP-254127-10-8A	10,000	3	25.4	<i>1.000</i>	12.7	<i>0.500</i>	27.9	<i>1.100</i>	16.9	<i>0.666</i>	87.4	<i>3.440</i>
MP-254254-10-8A	10,000	3	25.4	<i>1.000</i>	25.4	<i>1.000</i>	27.9	<i>1.100</i>	28.6	<i>1.125</i>	87.4	<i>3.440</i>
MP-305047-10-8A	10,000	2	30.5	<i>1.200</i>	4.7	<i>0.185</i>	33.0	<i>1.300</i>	7.8	<i>0.306</i>	69.5	<i>2.736</i>
MP-318064-10-8A	10,000	1	31.8	<i>1.250</i>	6.4	<i>0.250</i>	N/A	N/A	9.5	<i>0.375</i>	37.9	<i>1.490</i>
MP-318097-10-8A	10,000	1	31.8	<i>1.250</i>	9.7	<i>0.380</i>	N/A	N/A	12.7	<i>0.500</i>	37.8	<i>1.488</i>
MP-381020-10-8A	10,000	1	38.1	<i>1.500</i>	2.0	<i>0.080</i>	N/A	N/A	10.7	<i>0.423</i>	44.1	<i>1.740</i>
MP-381064-10-8A	10,000	1	38.1	<i>1.500</i>	6.4	<i>0.250</i>	N/A	N/A	9.5	<i>0.375</i>	44.5	<i>1.750</i>
MP-381127-5-8A	5,000	2	38.1	<i>1.500</i>	12.7	<i>0.500</i>	44.2	<i>1.738</i>	15.9	<i>0.625</i>	88.2	<i>3.472</i>
MP-381191-5-8A	5,000	2	38.1	<i>1.500</i>	19.1	<i>0.750</i>	43.2	<i>1.700</i>	22.2	<i>0.875</i>	87.6	<i>3.450</i>
MP-381381-2.5-8A	2,500	2	38.1	<i>1.500</i>	38.1	<i>1.500</i>	44.5	<i>1.750</i>	40.8	<i>1.607</i>	88.9	<i>3.500</i>
MP-381635-5-8A	5,000	2	38.1	<i>1.500</i>	63.5	<i>2.500</i>	40.6	<i>1.600</i>	66.7	<i>2.625</i>	84.7	<i>3.336</i>
MP-406254-1.5-8A	1,500	2	40.6	<i>1.600</i>	25.4	<i>1.000</i>	55.9	<i>2.200</i>	38.1	<i>1.500</i>	102.9	<i>4.050</i>
MP-445064-10-8A	10,000	1	44.5	<i>1.750</i>	6.4	<i>0.250</i>	N/A	N/A	9.5	<i>0.375</i>	50.4	<i>1.986</i>
MP-445102-5-8A	5,000	1	44.5	<i>1.750</i>	10.2	<i>0.400</i>	N/A	N/A	12.7	<i>0.500</i>	50.4	<i>1.986</i>
MP-445445-2-8A	2,000	1	44.5	<i>1.750</i>	44.5	<i>1.750</i>	N/A	N/A	47.6	<i>1.875</i>	50.4	<i>1.986</i>
MP-478175-5-8A	5,000	1	47.8	<i>1.875</i>	17.5	<i>0.690</i>	N/A	N/A	24.4	<i>0.962</i>	66.0	<i>2.600</i>
MP-508064-10-8A	10,000	1	50.8	<i>2.000</i>	6.4	<i>0.250</i>	N/A	N/A	9.5	<i>0.375</i>	56.9	<i>2.240</i>
MP-508095-5-8A	5,000	1	50.8	<i>2.000</i>	9.5	<i>0.375</i>	N/A	N/A	12.7	<i>0.500</i>	57.2	<i>2.250</i>
MP-508127-10-8A	10,000	1	50.8	<i>2.000</i>	12.7	<i>0.500</i>	N/A	N/A	15.9	<i>0.625</i>	56.9	<i>2.240</i>
MP-508254-5-8A	5,000	1	50.8	<i>2.000</i>	25.4	<i>1.000</i>	N/A	N/A	28.6	<i>1.125</i>	57.2	<i>2.250</i>
MP-508318-2.5-8A	2,500	1	50.8	<i>2.000</i>	31.8	<i>1.250</i>	N/A	N/A	34.9	<i>1.375</i>	56.9	<i>2.240</i>
MP-508508-3-8A	3,000	1	50.8	<i>2.000</i>	50.8	<i>2.000</i>	N/A	N/A	54.6	<i>2.150</i>	54.0	<i>2.130</i>
MP-523841-1.5-8A	1,500	1	52.3	<i>2.060</i>	84.1	<i>3.310</i>	N/A	N/A	88.9	<i>3.500</i>	58.2	<i>2.290</i>
MP-610419-2.5-8A	2,500	1	61.0	<i>2.400</i>	41.9	<i>1.650</i>	N/A	N/A	45.5	<i>1.792</i>	67.3	<i>2.650</i>
MP-699191-5-8A	5,000	1	69.9	<i>2.750</i>	19.1	<i>0.750</i>	N/A	N/A	23.3	<i>0.917</i>	76.2	<i>3.000</i>
MP-699254-5-8A	5,000	1	69.9	<i>2.750</i>	25.4	<i>1.000</i>	N/A	N/A	28.6	<i>1.125</i>	76.2	<i>3.000</i>
MP-762381-2.5-8A	2,500	1	76.2	<i>3.000</i>	38.1	<i>1.500</i>	N/A	N/A	41.3	<i>1.625</i>	82.3	<i>3.240</i>
MP-762508-2.5-8A	2,500	1	76.2	<i>3.000</i>	50.8	<i>2.000</i>	N/A	N/A	54.0	<i>2.125</i>	82.6	<i>3.240</i>
MP-762127-1-8A	1,000	1	76.2	<i>3.000</i>	127.0	<i>5.000</i>	N/A	N/A	129.5	<i>5.100</i>	79.4	<i>3.130</i>
MP-101508-2.5-8A	2,500	1	101.6	<i>4.000</i>	50.8	<i>2.000</i>	N/A	N/A	54.6	<i>2.150</i>	104.1	<i>4.100</i>
MP-101635-2.5-8A	2,500	1	101.6	<i>4.000</i>	63.5	<i>2.500</i>	N/A	N/A	66.7	<i>2.625</i>	107.7	<i>4.240</i>
MP-101762-1.8-8A	1,800	1	101.6	<i>4.000</i>	76.2	<i>3.000</i>	N/A	N/A	79.4	<i>3.125</i>	104.1	<i>4.100</i>
MP-101101-1.3-8A	1,300	1	101.6	<i>4.000</i>	101.6	<i>4.000</i>	N/A	N/A	104.8	<i>4.125</i>	104.1	<i>4.100</i>
MP-101165-0.85-8A	850	1	101.6	<i>4.000</i>	165.1	<i>6.500</i>	N/A	N/A	168.3	<i>6.680</i>	104.9	<i>4.130</i>

**MV Tamper-evident metalized polyester labels**

Tyco MV is a thermal transfer printable metalized polyester film with a permanent acrylic adhesive, designed with a tamper-evident feature which leaves a void footprint when removed. It is ideal for applications such as rating plate and serial number labels that require protection against removal. For guaranteed print performance and durability, use with Tyco's RHD series ribbon.

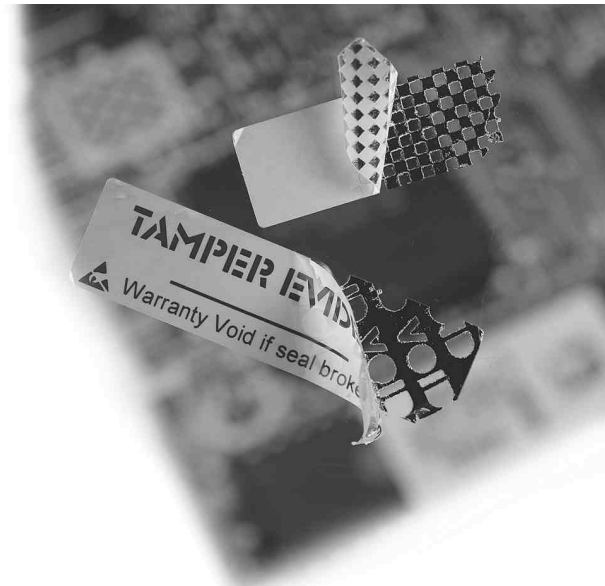

**Features and benefits**

- Thermal transfer printable.
- Metalized appearance.
- Ideal for security applications.
- UL Recognized.



<b>Adhesive</b>	Permanent acrylic
<b>Service temperature</b>	-40°C to +150°C    -40°F to +302°F
<b>Recommended printer</b>	T308S*
<b>Recommended ribbon</b>	1330-0607-10*
<small>*Alternative printers and ribbons are available for special applications. Contact Tyco Electronics Identification for more information.</small>	

**Part numbering system**

MV-044033-10-8A



**Ordering information**



**Product dimensions**

Product order code	Package quantity	Labels across	Label width (A)		Label height (B)		Horizontal repeat (C)		Vertical repeat (D)		Web width (E)	
			mm	<i>inches</i>	mm	<i>inches</i>	mm	<i>inches</i>	mm	<i>inches</i>	mm	<i>inches</i>
MV-040040-25-8A	25,000	20	4.0	<i>0.157</i>	4.0	<i>0.157</i>	4.0	<i>0.157</i>	7.2	<i>0.281</i>	86.0	<i>3.380</i>
MV-044033-10-8A	10,000	20	4.4	<i>0.170</i>	3.3	<i>0.130</i>	4.4	<i>0.170</i>	9.5	<i>0.375</i>	92.4	<i>3.636</i>
MV-064064-25-8A	25,000	12	6.4	<i>0.250</i>	6.4	<i>0.250</i>	6.4	<i>0.250</i>	9.5	<i>0.375</i>	82.2	<i>3.240</i>
MV-080080-10-8A	10,000	8	8.0	<i>0.315</i>	8.0	<i>0.315</i>	9.9	<i>0.390</i>	13.3	<i>0.525</i>	83.3	<i>3.280</i>
MV-089047-10-8A	10,000	5	8.9	<i>0.350</i>	4.7	<i>0.185</i>	11.4	<i>0.450</i>	7.9	<i>0.313</i>	60.6	<i>2.386</i>
MV-095080-25-8A	25,000	5	9.5	<i>0.375</i>	8.0	<i>0.315</i>	12.2	<i>0.480</i>	12.7	<i>0.500</i>	64.3	<i>2.531</i>
MV-095095-10-8A	10,000	7	9.5	<i>0.375</i>	9.5	<i>0.375</i>	11.1	<i>0.437</i>	12.7	<i>0.500</i>	82.1	<i>3.230</i>
MV-114040-25-8A	25,000	6	11.4	<i>0.450</i>	4.0	<i>0.157</i>	11.4	<i>0.450</i>	7.2	<i>0.281</i>	74.6	<i>2.940</i>
MV-127032-10-8A	10,000	5	12.7	<i>0.500</i>	3.2	<i>0.125</i>	19.1	<i>0.750</i>	3.2	<i>0.250</i>	94.9	<i>3.736</i>

(continued)

**MV Tamper-evident metalized polyester labels (Cont'd)**

**Product dimensions (continued)**

Product order code	Package quantity	Labels across	Label width (A)		Label height (B)		Horizontal repeat (C)		Vertical repeat (D)		Web width (E)	
			mm	<i>inches</i>	mm	<i>inches</i>	mm	<i>inches</i>	mm	<i>inches</i>	mm	<i>inches</i>
MV-127111-10-8A	10,000	5	12.7	<i>0.500</i>	11.1	<i>0.437</i>	16.8	<i>0.662</i>	14.3	<i>0.563</i>	86.0	<i>3.380</i>
MV-127127-10-8A	10,000	5	12.7	<i>0.500</i>	12.7	<i>0.500</i>	15.9	<i>0.625</i>	15.9	<i>0.625</i>	82.6	<i>3.250</i>
MV-165051-25-8A	25,000	4	16.5	<i>0.650</i>	5.1	<i>0.200</i>	17.8	<i>0.700</i>	8.3	<i>0.325</i>	75.8	<i>2.990</i>
MV-165102-10-8A	10,000	5	16.5	<i>0.650</i>	10.2	<i>0.400</i>	19.1	<i>0.750</i>	13.8	<i>0.545</i>	99.1	<i>3.900</i>
MV-171171-10-8A	10,000	5	17.1	<i>0.674</i>	17.1	<i>0.674</i>	19.7	<i>0.774</i>	20.3	<i>0.800</i>	101.8	<i>4.006</i>
MV-178095-10-8A	10,000	4	17.8	<i>0.700</i>	9.5	<i>0.375</i>	19.1	<i>0.750</i>	12.7	<i>0.500</i>	80.9	<i>3.190</i>
MV-191064-10-8A	10,000	4	19.1	<i>0.750</i>	6.4	<i>0.250</i>	21.6	<i>0.850</i>	9.5	<i>0.375</i>	89.9	<i>3.540</i>
MV-191114-15-8A	15,000	3	19.1	<i>0.750</i>	11.4	<i>0.450</i>	22.2	<i>0.875</i>	14.7	<i>0.579</i>	69.5	<i>2.736</i>
MV-191762-5-8A	5,000	3	19.1	<i>0.750</i>	76.2	<i>3.000</i>	21.6	<i>0.850</i>	88.9	<i>3.500</i>	68.2	<i>2.686</i>
MV-203127-10-8A	10,000	4	20.3	<i>0.800</i>	12.7	<i>0.500</i>	22.9	<i>0.900</i>	15.9	<i>0.625</i>	94.6	<i>3.730</i>
MV-208086-5-8A	5,000	4	20.8	<i>0.820</i>	8.6	<i>0.340</i>	24.1	<i>0.950</i>	12.7	<i>0.500</i>	101.6	<i>4.000</i>
MV-222159-15-8A	15,000	2	22.2	<i>0.875</i>	15.9	<i>0.625</i>	24.8	<i>0.975</i>	19.1	<i>0.750</i>	53.0	<i>2.086</i>
MV-229064-10-8A	10,000	3	22.9	<i>0.900</i>	6.4	<i>0.250</i>	28.6	<i>1.125</i>	9.5	<i>0.375</i>	86.0	<i>3.390</i>
MV-250381-10-8A	10,000	4	24.9	<i>0.980</i>	38.1	<i>1.500</i>	27.4	<i>1.080</i>	47.6	<i>1.875</i>	113.5	<i>4.470</i>
MV-254045-10-8A	10,000	3	25.4	<i>1.000</i>	4.6	<i>0.180</i>	31.8	<i>1.250</i>	8.5	<i>0.333</i>	95.3	<i>3.750</i>
MV-254064-10-8A	10,000	3	25.4	<i>1.000</i>	6.4	<i>0.250</i>	27.9	<i>1.100</i>	9.5	<i>0.375</i>	87.3	<i>3.436</i>
MV-254097-10-8A	10,000	3	25.4	<i>1.000</i>	9.7	<i>0.380</i>	27.9	<i>1.100</i>	12.7	<i>0.500</i>	87.4	<i>3.440</i>
MV-254127-10-8A	10,000	3	25.4	<i>1.000</i>	12.7	<i>0.500</i>	27.9	<i>1.100</i>	16.9	<i>0.666</i>	87.4	<i>3.440</i>
MV-254254-10-8A	10,000	3	25.4	<i>1.000</i>	25.4	<i>1.000</i>	27.9	<i>1.100</i>	28.6	<i>1.125</i>	87.4	<i>3.440</i>
MV-305047-10-8A	10,000	2	30.5	<i>1.200</i>	4.7	<i>0.185</i>	33.0	<i>1.300</i>	7.8	<i>0.306</i>	69.5	<i>2.736</i>
MV-318064-10-8A	10,000	1	31.8	<i>1.250</i>	6.4	<i>0.250</i>	N/A	N/A	9.5	<i>0.375</i>	37.9	<i>1.490</i>
MV-318097-10-8A	10,000	1	31.8	<i>1.250</i>	9.7	<i>0.380</i>	N/A	N/A	12.7	<i>0.500</i>	37.8	<i>1.486</i>
MV-381020-10-8A	10,000	1	38.1	<i>1.500</i>	2.0	<i>0.080</i>	N/A	N/A	10.7	<i>0.423</i>	44.1	<i>1.740</i>
MV-381064-10-8A	10,000	1	38.1	<i>1.500</i>	6.4	<i>0.250</i>	N/A	N/A	9.5	<i>0.375</i>	44.5	<i>1.750</i>
MV-381127-5-8A	5,000	2	38.1	<i>1.500</i>	12.7	<i>0.500</i>	44.2	<i>1.738</i>	15.9	<i>0.625</i>	88.2	<i>3.472</i>
MV-381191-5-8A	5,000	2	38.1	<i>1.500</i>	19.1	<i>0.750</i>	43.2	<i>1.700</i>	22.2	<i>0.875</i>	87.6	<i>3.450</i>
MV-381381-2.5-8A	2,500	2	38.1	<i>1.500</i>	38.1	<i>1.500</i>	44.5	<i>1.750</i>	40.8	<i>1.607</i>	88.9	<i>3.500</i>
MV-381635-5-8A	5,000	2	38.1	<i>1.500</i>	63.5	<i>2.500</i>	40.6	<i>1.600</i>	66.7	<i>2.625</i>	84.7	<i>3.336</i>
MV-406254-1.5-8A	1,500	2	40.6	<i>1.600</i>	25.4	<i>1.000</i>	55.9	<i>2.200</i>	38.1	<i>1.500</i>	102.9	<i>4.050</i>
MV-445064-10-8A	10,000	1	44.5	<i>1.750</i>	6.4	<i>0.250</i>	N/A	N/A	9.5	<i>0.375</i>	50.4	<i>1.986</i>
MV-445102-5-8A	5,000	1	44.5	<i>1.750</i>	10.2	<i>0.400</i>	N/A	N/A	12.7	<i>0.500</i>	50.4	<i>1.986</i>
MV-445445-2-8A	2,000	1	44.5	<i>1.750</i>	44.5	<i>1.750</i>	N/A	N/A	47.6	<i>1.875</i>	50.4	<i>1.986</i>
MV-478175-5-8A	5,000	1	47.8	<i>1.880</i>	17.5	<i>0.690</i>	N/A	N/A	24.4	<i>0.962</i>	66.0	<i>2.600</i>
MV-508064-10-8A	10,000	1	50.8	<i>2.000</i>	6.4	<i>0.250</i>	N/A	N/A	9.5	<i>0.375</i>	56.9	<i>2.240</i>
MV-508095-5-8A	5,000	1	50.8	<i>2.000</i>	9.5	<i>0.375</i>	N/A	N/A	12.7	<i>0.500</i>	57.2	<i>2.250</i>
MV-508127-10-8A	10,000	1	50.8	<i>2.000</i>	12.7	<i>0.500</i>	N/A	N/A	15.9	<i>0.625</i>	56.9	<i>2.240</i>
MV-508254-5-8A	5,000	1	50.8	<i>2.000</i>	25.4	<i>1.000</i>	N/A	N/A	28.6	<i>1.125</i>	57.2	<i>2.250</i>
MV-508318-2.5-8A	2,500	1	50.8	<i>2.000</i>	31.8	<i>1.250</i>	N/A	N/A	34.9	<i>1.375</i>	56.9	<i>2.240</i>
MV-508508-3-8A	3,000	1	50.8	<i>2.000</i>	50.8	<i>2.000</i>	N/A	N/A	54.6	<i>2.150</i>	54.0	<i>2.130</i>
MV-523841-1.5-8A	1,500	1	52.3	<i>2.060</i>	84.1	<i>3.310</i>	N/A	N/A	88.9	<i>3.500</i>	58.2	<i>2.290</i>
MV-610419-2.5-8A	2,500	1	61.0	<i>2.400</i>	41.9	<i>1.650</i>	N/A	N/A	45.5	<i>1.792</i>	67.3	<i>2.650</i>
MV-699191-5-8A	5,000	1	69.9	<i>2.750</i>	19.1	<i>0.750</i>	N/A	N/A	23.3	<i>0.917</i>	76.2	<i>3.000</i>
MV-699254-5-8A	5,000	1	69.9	<i>2.750</i>	25.4	<i>1.000</i>	N/A	N/A	28.6	<i>1.125</i>	76.2	<i>3.000</i>
MV-762381-2.5-8A	2,500	1	76.2	<i>3.000</i>	38.1	<i>1.500</i>	N/A	N/A	41.3	<i>1.625</i>	82.3	<i>3.240</i>
MV-762508-2.5-8A	2,500	1	76.2	<i>3.000</i>	50.8	<i>2.000</i>	N/A	N/A	54.0	<i>2.125</i>	82.6	<i>3.240</i>
MV-762127-1-8A	1,000	1	76.2	<i>3.000</i>	127.0	<i>5.000</i>	N/A	N/A	129.5	<i>5.100</i>	79.4	<i>3.130</i>
MV-101508-2.5-8A	2,500	1	101.6	<i>4.000</i>	50.8	<i>2.000</i>	N/A	N/A	54.6	<i>2.150</i>	104.1	<i>4.100</i>
MV-101635-2.5-8A	2,500	1	101.6	<i>4.000</i>	63.5	<i>2.500</i>	N/A	N/A	66.7	<i>2.625</i>	107.7	<i>4.240</i>
MV-101762-1.8-8A	1,800	1	101.6	<i>4.000</i>	76.2	<i>3.000</i>	N/A	N/A	79.4	<i>3.125</i>	104.1	<i>4.100</i>
MV-101101-1.3-8A	1,300	1	101.6	<i>4.000</i>	101.6	<i>4.000</i>	N/A	N/A	104.8	<i>4.125</i>	104.1	<i>4.100</i>
MV-101165-0.85-8A	850	1	101.6	<i>4.000</i>	165.1	<i>6.500</i>	N/A	N/A	168.3	<i>6.680</i>	104.9	<i>4.130</i>

**TN Tamper proof destructible polyethylene labels**

Tyco TN is a thermal transfer printable, tamper proof destructible polyethylene label with a permanent acrylic adhesive, designed to fracture upon removal after 72 hours. It is ideal for serial number labels and calibration information labeling, or other applications that require a tamper proof label. For guaranteed print performance and durability, use with Tyco's RHD series ribbon.



**Features and benefits**

- Thermal transfer printable.
- Ideal for security applications.
- Several die-cut sizes available.



<b>Adhesive</b>	Permanent rubber-based	
<b>Service temperature</b>	-40°C to +80°C	-40°F to +176°F
<b>Recommended printer</b>	T308S*	
<b>Recommended ribbon</b>	1330-0607-10*	
	<small>*Alternative printers and ribbons are available for special applications. Contact Tyco Electronics Identification for more information.</small>	

**Part numbering system**

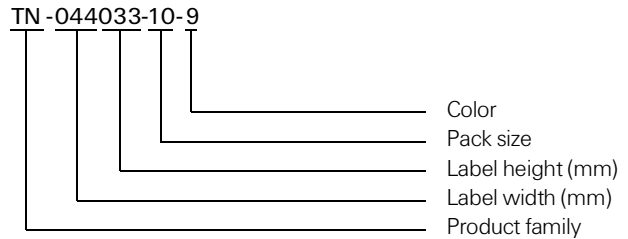

**Ordering information**



**Product dimensions**

Product order code	Package quantity	Labels across	Label width (A)		Label height (B)		Horizontal repeat (C)		Vertical repeat (D)		Web width (E)	
			mm	<i>inches</i>	mm	<i>inches</i>	mm	<i>inches</i>	mm	<i>inches</i>	mm	<i>inches</i>
TN-040040-25-9	25,000	20	4.0	<i>0.157</i>	4.0	<i>0.157</i>	4.0	<i>0.157</i>	7.2	<i>0.281</i>	86.0	<i>3.380</i>
TN-044033-10-9	10,000	20	4.4	<i>0.170</i>	3.3	<i>0.130</i>	4.4	<i>0.170</i>	9.5	<i>0.375</i>	92.4	<i>3.636</i>
TN-064064-25-9	25,000	12	6.4	<i>0.250</i>	6.4	<i>0.250</i>	6.4	<i>0.250</i>	9.5	<i>0.375</i>	82.2	<i>3.240</i>
TN-080080-10-9	10,000	8	8.0	<i>0.315</i>	8.0	<i>0.315</i>	9.9	<i>0.390</i>	13.3	<i>0.525</i>	83.3	<i>3.280</i>
TN-089047-10-9	10,000	5	8.9	<i>0.350</i>	4.7	<i>0.185</i>	11.4	<i>0.450</i>	7.9	<i>0.313</i>	60.6	<i>2.386</i>
TN-095080-25-9	25,000	5	9.5	<i>0.375</i>	8.0	<i>0.315</i>	12.2	<i>0.480</i>	12.7	<i>0.500</i>	64.3	<i>2.531</i>
TN-095095-10-9	10,000	7	9.5	<i>0.375</i>	9.5	<i>0.375</i>	11.1	<i>0.437</i>	12.7	<i>0.500</i>	82.1	<i>3.230</i>
TN-114040-25-9	25,000	6	11.4	<i>0.450</i>	4.0	<i>0.157</i>	11.4	<i>0.450</i>	7.2	<i>0.281</i>	74.6	<i>2.940</i>
TN-127032-10-9	10,000	5	12.7	<i>0.500</i>	3.2	<i>0.125</i>	19.1	<i>0.750</i>	3.2	<i>0.250</i>	94.9	<i>3.736</i>

(continued)

**Product dimensions (continued)**

Product order code	Package quantity	Labels across	Label width (A)		Label height (B)		Horizontal repeat (C)		Vertical repeat (D)		Web width (E)	
			mm	<i>inches</i>	mm	<i>inches</i>	mm	<i>inches</i>	mm	<i>inches</i>	mm	<i>inches</i>
TN-127111-10-9	10,000	5	12.7	<i>0.500</i>	11.1	<i>0.437</i>	16.8	<i>0.662</i>	14.3	<i>0.563</i>	86.0	<i>3.380</i>
TN-127127-10-9	10,000	5	12.7	<i>0.500</i>	12.7	<i>0.500</i>	15.9	<i>0.625</i>	15.9	<i>0.625</i>	82.6	<i>3.250</i>
TN-165051-25-9	25,000	4	16.5	<i>0.650</i>	5.1	<i>0.200</i>	17.8	<i>0.700</i>	8.3	<i>0.325</i>	75.8	<i>2.990</i>
TN-165102-10-9	10,000	5	16.5	<i>0.650</i>	10.2	<i>0.400</i>	19.1	<i>0.750</i>	13.8	<i>0.545</i>	99.1	<i>3.900</i>
TN-171171-10-9	10,000	5	17.1	<i>0.674</i>	17.1	<i>0.674</i>	19.7	<i>0.774</i>	20.3	<i>0.800</i>	101.8	<i>4.006</i>
TN-178095-10-9	10,000	4	17.8	<i>0.700</i>	9.5	<i>0.375</i>	19.1	<i>0.750</i>	12.7	<i>0.500</i>	80.9	<i>3.190</i>
TN-191064-10-9	10,000	4	19.1	<i>0.750</i>	6.4	<i>0.250</i>	21.6	<i>0.850</i>	9.5	<i>0.375</i>	89.9	<i>3.540</i>
TN-191114-15-9	15,000	3	19.1	<i>0.750</i>	11.4	<i>0.450</i>	22.2	<i>0.875</i>	14.7	<i>0.579</i>	69.5	<i>2.736</i>
TN-191762-5-9	5,000	3	19.1	<i>0.750</i>	76.2	<i>3.000</i>	21.6	<i>0.850</i>	88.9	<i>3.500</i>	68.2	<i>2.686</i>
TN-203127-10-9	10,000	4	20.3	<i>0.800</i>	12.7	<i>0.500</i>	22.9	<i>0.900</i>	15.9	<i>0.625</i>	94.6	<i>3.730</i>
TN-208086-5-9	5,000	4	20.8	<i>0.820</i>	8.6	<i>0.340</i>	24.1	<i>0.950</i>	12.7	<i>0.500</i>	101.6	<i>4.000</i>
TN-222159-15-9	15,000	2	22.2	<i>0.875</i>	15.9	<i>0.625</i>	24.8	<i>0.975</i>	19.1	<i>0.750</i>	53.0	<i>2.086</i>
TN-229064-10-9	10,000	3	22.9	<i>0.900</i>	6.4	<i>0.250</i>	28.6	<i>1.125</i>	9.5	<i>0.375</i>	86.0	<i>3.390</i>
TN-250381-10-9	10,000	4	24.9	<i>0.980</i>	38.1	<i>1.500</i>	27.4	<i>1.080</i>	47.6	<i>1.875</i>	113.5	<i>4.470</i>
TN-254045-10-9	10,000	3	25.4	<i>1.000</i>	4.6	<i>0.180</i>	31.8	<i>1.250</i>	8.5	<i>0.333</i>	95.3	<i>3.750</i>
TN-254064-10-9	10,000	3	25.4	<i>1.000</i>	6.4	<i>0.250</i>	27.9	<i>1.100</i>	9.5	<i>0.375</i>	87.3	<i>3.436</i>
TN-254097-10-9	10,000	3	25.4	<i>1.000</i>	9.7	<i>0.380</i>	27.9	<i>1.100</i>	12.7	<i>0.500</i>	87.4	<i>3.440</i>
TN-254127-10-9	10,000	3	25.4	<i>1.000</i>	12.7	<i>0.500</i>	27.9	<i>1.100</i>	16.9	<i>0.666</i>	87.4	<i>3.440</i>
TN-254254-10-9	10,000	3	25.4	<i>1.000</i>	25.4	<i>1.000</i>	27.9	<i>1.100</i>	28.6	<i>1.125</i>	87.4	<i>3.440</i>
TN-305047-10-9	10,000	2	30.5	<i>1.200</i>	4.7	<i>0.185</i>	33.0	<i>1.300</i>	7.8	<i>0.306</i>	69.5	<i>2.736</i>
TN-318064-10-9	10,000	1	31.8	<i>1.250</i>	6.4	<i>0.250</i>	N/A	N/A	9.5	<i>0.375</i>	37.9	<i>1.490</i>
TN-318097-10-9	10,000	1	31.8	<i>1.250</i>	9.7	<i>0.380</i>	N/A	N/A	12.7	<i>0.500</i>	37.8	<i>1.488</i>
TN-381020-10-9	10,000	1	38.1	<i>1.500</i>	2.0	<i>0.080</i>	N/A	N/A	10.7	<i>0.423</i>	44.1	<i>1.740</i>
TN-381064-10-9	10,000	1	38.1	<i>1.500</i>	6.4	<i>0.250</i>	N/A	N/A	9.5	<i>0.375</i>	44.5	<i>1.750</i>
TN-381127-5-9	5,000	2	38.1	<i>1.500</i>	12.7	<i>0.500</i>	44.2	<i>1.738</i>	15.9	<i>0.625</i>	88.2	<i>3.472</i>
TN-381191-5-9	5,000	2	38.1	<i>1.500</i>	19.1	<i>0.750</i>	43.2	<i>1.700</i>	22.2	<i>0.875</i>	87.6	<i>3.450</i>
TN-381381-2.5-9	2,500	2	38.1	<i>1.500</i>	38.1	<i>1.500</i>	44.5	<i>1.750</i>	40.8	<i>1.607</i>	88.9	<i>3.500</i>
TN-381635-5-9	5,000	2	38.1	<i>1.500</i>	63.5	<i>2.500</i>	40.6	<i>1.600</i>	66.7	<i>2.625</i>	84.7	<i>3.336</i>
TN-406254-1.5-9	1,500	2	40.6	<i>1.600</i>	25.4	<i>1.000</i>	55.9	<i>2.200</i>	38.1	<i>1.500</i>	102.9	<i>4.050</i>
TN-445064-10-9	10,000	1	44.5	<i>1.750</i>	6.4	<i>0.250</i>	N/A	N/A	9.5	<i>0.375</i>	50.4	<i>1.986</i>
TN-445102-5-9	5,000	1	44.5	<i>1.750</i>	10.2	<i>0.400</i>	N/A	N/A	12.7	<i>0.500</i>	50.4	<i>1.986</i>
TN-445445-2-9	2,000	1	44.5	<i>1.750</i>	44.5	<i>1.750</i>	N/A	N/A	47.6	<i>1.875</i>	50.4	<i>1.986</i>
TN-478175-5-9	5,000	1	47.8	<i>1.880</i>	17.5	<i>0.690</i>	N/A	N/A	24.4	<i>0.962</i>	66.0	<i>2.600</i>
TN-508064-10-9	10,000	1	50.8	<i>2.000</i>	6.4	<i>0.250</i>	N/A	N/A	9.5	<i>0.375</i>	56.9	<i>2.240</i>
TN-508095-5-9	5,000	1	50.8	<i>2.000</i>	9.5	<i>0.375</i>	N/A	N/A	12.7	<i>0.500</i>	57.2	<i>2.250</i>
TN-508127-10-9	10,000	1	50.8	<i>2.000</i>	12.7	<i>0.500</i>	N/A	N/A	15.9	<i>0.625</i>	56.9	<i>2.240</i>
TN-508254-5-9	5,000	1	50.8	<i>2.000</i>	25.4	<i>1.000</i>	N/A	N/A	28.6	<i>1.125</i>	57.2	<i>2.250</i>
TN-508318-2.5-9	2,500	1	50.8	<i>2.000</i>	31.8	<i>1.250</i>	N/A	N/A	34.9	<i>1.375</i>	56.9	<i>2.240</i>
TN-508508-3-9	3,000	1	50.8	<i>2.000</i>	50.8	<i>2.000</i>	N/A	N/A	54.6	<i>2.150</i>	54.0	<i>2.130</i>
TN-523841-1.5-9	1,500	1	52.3	<i>2.060</i>	84.1	<i>3.310</i>	N/A	N/A	88.9	<i>3.500</i>	58.2	<i>2.290</i>
TN-610419-2.5-9	2,500	1	61.0	<i>2.400</i>	41.9	<i>1.650</i>	N/A	N/A	45.5	<i>1.792</i>	67.3	<i>2.650</i>
TN-699191-5-9	5,000	1	69.9	<i>2.750</i>	19.1	<i>0.750</i>	N/A	N/A	23.3	<i>0.917</i>	76.2	<i>3.000</i>
TN-699254-5-9	5,000	1	69.9	<i>2.750</i>	25.4	<i>1.000</i>	N/A	N/A	28.6	<i>1.125</i>	76.2	<i>3.000</i>
TN-762381-2.5-9	2,500	1	76.2	<i>3.000</i>	38.1	<i>1.500</i>	N/A	N/A	41.3	<i>1.625</i>	82.3	<i>3.240</i>
TN-762508-2.5-9	2,500	1	76.2	<i>3.000</i>	50.8	<i>2.000</i>	N/A	N/A	54.0	<i>2.125</i>	82.6	<i>3.240</i>
TN-762127-1-9	1,000	1	76.2	<i>3.000</i>	127.0	<i>5.000</i>	N/A	N/A	129.5	<i>5.100</i>	79.4	<i>3.130</i>
TN-101508-2.5-9	2,500	1	101.6	<i>4.000</i>	50.8	<i>2.000</i>	N/A	N/A	54.6	<i>2.150</i>	104.1	<i>4.100</i>
TN-101635-2.5-9	2,500	1	101.6	<i>4.000</i>	63.5	<i>2.500</i>	N/A	N/A	66.7	<i>2.625</i>	107.7	<i>4.240</i>
TN-101762-1.8-9	1,800	1	101.6	<i>4.000</i>	76.2	<i>3.000</i>	N/A	N/A	79.4	<i>3.125</i>	104.1	<i>4.100</i>
TN-101101-1.3-9	1,300	1	101.6	<i>4.000</i>	101.6	<i>4.000</i>	N/A	N/A	104.8	<i>4.125</i>	104.1	<i>4.100</i>
TN-101165-0.85-9	850	1	101.6	<i>4.000</i>	165.1	<i>6.500</i>	N/A	N/A	168.3	<i>6.680</i>	104.9	<i>4.130</i>

**WV White vinyl labels**

Tyco WV is a thermal transfer printable, flexible white vinyl film with a permanent acrylic adhesive. It offers excellent conformability to round, irregular or flexible surfaces, and is ideal for wire and cable identification, including flat ribbon cables that are subject to repeated bending. WV is resistant to oil, mild solvents, water and outdoor exposure. For guaranteed print performance and durability use with Tyco's 3300 series ribbon.

**Features and benefits**

- Thermal transfer printable.
- High tack adhesive bonds to most substrates including painted metal and low surface energy plastics such as polyethylene.
- UL Listed and CSA Certified.



<b>Adhesive</b>	Permanent acrylic high initial tack	
<b>Service temperature</b>	-60°C to +95°C	-76°F to +203°F
<b>Recommended printer</b>	T308S*	
<b>Recommended ribbon</b>	1330-3300-10*	
	<i>*Alternative printers and ribbons are available for special applications. Contact Tyco Electronics Identification for more information.</i>	

**Part numbering system**

**WV-044033-10-9**



**Ordering information**



**Product dimensions**

Product order code	Package quantity	Labels across	Label width (A)		Label height (B)		Horizontal repeat (C)		Vertical repeat (D)		Web width (E)	
			mm	<i>inches</i>	mm	<i>inches</i>	mm	<i>inches</i>	mm	<i>inches</i>	mm	<i>inches</i>
WV-040040-25-9	25,000	20	4.0	<i>0.157</i>	4.0	<i>0.157</i>	4.0	<i>0.157</i>	7.2	<i>0.281</i>	86.0	<i>3.380</i>
WV-044033-10-9	10,000	20	4.4	<i>0.170</i>	3.3	<i>0.130</i>	4.4	<i>0.170</i>	9.5	<i>0.375</i>	92.4	<i>3.636</i>
WV-080080-10-9	10,000	8	8.0	<i>0.315</i>	8.0	<i>0.315</i>	9.9	<i>0.390</i>	13.3	<i>0.525</i>	83.3	<i>3.280</i>
WV-089047-10-9	10,000	5	8.9	<i>0.350</i>	4.7	<i>0.185</i>	11.4	<i>0.450</i>	7.9	<i>0.313</i>	60.6	<i>2.386</i>
WV-095080-25-9	25,000	5	9.5	<i>0.375</i>	8.0	<i>0.315</i>	12.2	<i>0.480</i>	12.7	<i>0.500</i>	64.3	<i>2.531</i>
WV-095095-10-9	10,000	7	9.5	<i>0.375</i>	9.5	<i>0.375</i>	11.1	<i>0.437</i>	12.7	<i>0.500</i>	82.1	<i>3.230</i>
WV-114040-25-9	25,000	6	11.4	<i>0.450</i>	4.0	<i>0.157</i>	11.4	<i>0.450</i>	7.2	<i>0.281</i>	74.6	<i>2.940</i>
WV-127032-10-9	10,000	5	12.7	<i>0.500</i>	3.2	<i>0.125</i>	19.1	<i>0.750</i>	3.2	<i>0.250</i>	94.9	<i>3.736</i>
WV-127111-10-9	10,000	5	12.7	<i>0.500</i>	11.1	<i>0.437</i>	16.8	<i>0.662</i>	14.3	<i>0.563</i>	86.0	<i>3.380</i>

(continued)



**Product dimensions (continued)**

Product order code	Package quantity	Labels across	Label width (A)		Label height (B)		Horizontal repeat (C)		Vertical repeat (D)		Web width (E)	
			mm	<i>inches</i>	mm	<i>inches</i>	mm	<i>inches</i>	mm	<i>inches</i>	mm	<i>inches</i>
WV-127127-10-9	10,000	5	12.7	<i>0.500</i>	12.7	<i>0.500</i>	15.9	<i>0.625</i>	15.9	<i>0.625</i>	82.6	<i>3.250</i>
WV-165051-25-9	25,000	4	16.5	<i>0.650</i>	5.1	<i>0.200</i>	17.8	<i>0.700</i>	8.3	<i>0.325</i>	75.8	<i>2.990</i>
WV-165102-10-9	10,000	5	16.5	<i>0.650</i>	10.2	<i>0.400</i>	19.1	<i>0.750</i>	13.8	<i>0.545</i>	99.1	<i>3.900</i>
WV-171171-10-9	10,000	5	17.1	<i>0.674</i>	17.1	<i>0.674</i>	19.7	<i>0.774</i>	20.3	<i>0.800</i>	101.8	<i>4.006</i>
WV-178095-10-9	10,000	4	17.8	<i>0.700</i>	9.5	<i>0.375</i>	19.1	<i>0.750</i>	12.7	<i>0.500</i>	80.9	<i>3.190</i>
WV-191064-10-9	10,000	4	19.1	<i>0.750</i>	6.4	<i>0.250</i>	21.6	<i>0.850</i>	9.5	<i>0.375</i>	89.9	<i>3.540</i>
WV-191114-15-9	15,000	3	19.1	<i>0.750</i>	11.4	<i>0.450</i>	22.2	<i>0.875</i>	14.7	<i>0.579</i>	69.5	<i>2.736</i>
WV-191762-5-9	5,000	3	19.1	<i>0.750</i>	76.2	<i>3.000</i>	21.6	<i>0.850</i>	88.9	<i>3.500</i>	68.2	<i>2.686</i>
WV-203127-10-9	10,000	4	20.3	<i>0.800</i>	12.7	<i>0.500</i>	22.9	<i>0.900</i>	15.9	<i>0.625</i>	94.6	<i>3.730</i>
WV-208086-5-9	5,000	4	20.8	<i>0.820</i>	8.6	<i>0.340</i>	24.1	<i>0.950</i>	12.7	<i>0.500</i>	101.6	<i>4.000</i>
WV-222159-15-9	15,000	2	22.2	<i>0.875</i>	15.9	<i>0.625</i>	24.8	<i>0.975</i>	19.1	<i>0.750</i>	53.0	<i>2.086</i>
WV-229064-10-9	10,000	3	22.9	<i>0.900</i>	6.4	<i>0.250</i>	28.6	<i>1.125</i>	9.5	<i>0.375</i>	86.0	<i>3.390</i>
WV-250381-10-9	10,000	4	24.9	<i>0.980</i>	38.1	<i>1.500</i>	27.4	<i>1.080</i>	47.6	<i>1.875</i>	113.5	<i>4.470</i>
WV-254045-10-9	10,000	3	25.4	<i>1.000</i>	4.6	<i>0.180</i>	31.8	<i>1.250</i>	8.5	<i>0.333</i>	95.3	<i>3.750</i>
WV-254064-10-9	10,000	3	25.4	<i>1.000</i>	6.4	<i>0.250</i>	27.9	<i>1.100</i>	9.5	<i>0.375</i>	87.3	<i>3.436</i>
WV-254097-10-9	10,000	3	25.4	<i>1.000</i>	9.7	<i>0.380</i>	27.9	<i>1.100</i>	12.7	<i>0.500</i>	87.4	<i>3.440</i>
WV-254127-10-9	10,000	3	25.4	<i>1.000</i>	12.7	<i>0.500</i>	27.9	<i>1.100</i>	16.9	<i>0.666</i>	87.4	<i>3.440</i>
WV-254254-10-9	10,000	3	25.4	<i>1.000</i>	25.4	<i>1.000</i>	27.9	<i>1.100</i>	28.6	<i>1.125</i>	87.4	<i>3.440</i>
WV-305047-10-9	10,000	2	30.5	<i>1.200</i>	4.7	<i>0.185</i>	33.0	<i>1.300</i>	7.8	<i>0.306</i>	69.5	<i>2.736</i>
WV-318064-10-9	10,000	1	31.8	<i>1.250</i>	6.4	<i>0.250</i>	N/A	N/A	9.5	<i>0.375</i>	37.9	<i>1.490</i>
WV-318097-10-9	10,000	1	31.8	<i>1.250</i>	9.7	<i>0.380</i>	N/A	N/A	12.7	<i>0.500</i>	37.8	<i>1.488</i>
WV-381020-10-9	10,000	1	38.1	<i>1.500</i>	2.0	<i>0.080</i>	N/A	N/A	10.7	<i>0.423</i>	44.1	<i>1.740</i>
WV-381064-10-9	10,000	1	38.1	<i>1.500</i>	6.4	<i>0.250</i>	N/A	N/A	9.5	<i>0.375</i>	44.5	<i>1.750</i>
WV-381127-5-9	5,000	2	38.1	<i>1.500</i>	12.7	<i>0.500</i>	44.2	<i>1.738</i>	15.9	<i>0.625</i>	88.2	<i>3.472</i>
WV-381191-5-9	5,000	2	38.1	<i>1.500</i>	19.1	<i>0.750</i>	43.2	<i>1.700</i>	22.2	<i>0.875</i>	87.6	<i>3.450</i>
WV-381381-2.5-9	2,500	2	38.1	<i>1.500</i>	38.1	<i>1.500</i>	44.5	<i>1.750</i>	40.8	<i>1.607</i>	88.9	<i>3.500</i>
WV-445064-10-9	10,000	1	44.5	<i>1.750</i>	6.4	<i>0.250</i>	N/A	N/A	9.5	<i>0.375</i>	50.4	<i>1.986</i>
WV-445102-5-9	5,000	1	44.5	<i>1.750</i>	10.2	<i>0.400</i>	N/A	N/A	12.7	<i>0.500</i>	50.4	<i>1.986</i>
WV-445445-2-9	2,000	1	44.5	<i>1.750</i>	44.5	<i>1.750</i>	N/A	N/A	47.6	<i>1.875</i>	50.4	<i>1.986</i>
WV-478175-5-9	5,000	1	47.8	<i>1.880</i>	17.5	<i>0.690</i>	N/A	N/A	24.4	<i>0.962</i>	66.0	<i>2.600</i>
WV-508064-10-9	10,000	1	50.8	<i>2.000</i>	6.4	<i>0.250</i>	N/A	N/A	9.5	<i>0.375</i>	56.9	<i>2.240</i>
WV-508095-5-9	5,000	1	50.8	<i>2.000</i>	9.5	<i>0.375</i>	N/A	N/A	12.7	<i>0.500</i>	57.2	<i>2.250</i>
WV-508127-10-9	10,000	1	50.8	<i>2.000</i>	12.7	<i>0.500</i>	N/A	N/A	15.9	<i>0.625</i>	56.9	<i>2.240</i>
WV-508254-5-9	5,000	1	50.8	<i>2.000</i>	25.4	<i>1.000</i>	N/A	N/A	28.6	<i>1.125</i>	57.2	<i>2.250</i>
WV-508318-2.5-9	2,500	1	50.8	<i>2.000</i>	31.8	<i>1.250</i>	N/A	N/A	34.9	<i>1.375</i>	56.9	<i>2.240</i>
WV-508508-3-9	3,000	1	50.8	<i>2.000</i>	50.8	<i>2.000</i>	N/A	N/A	54.6	<i>2.150</i>	54.0	<i>2.130</i>
WV-523841-1.5-9	1,500	1	52.3	<i>2.060</i>	84.1	<i>3.310</i>	N/A	N/A	88.9	<i>3.500</i>	58.2	<i>2.290</i>
WV-610419-2.5-9	2,500	1	61.0	<i>2.400</i>	41.9	<i>1.650</i>	N/A	N/A	45.5	<i>1.792</i>	67.3	<i>2.650</i>
WV-699191-5-9	5,000	1	69.9	<i>2.750</i>	19.1	<i>0.750</i>	N/A	N/A	23.3	<i>0.917</i>	76.2	<i>3.000</i>
WV-699254-5-9	5,000	1	69.9	<i>2.750</i>	25.4	<i>1.000</i>	N/A	N/A	28.6	<i>1.125</i>	76.2	<i>3.000</i>
WV-762381-2.5-9	2,500	1	76.2	<i>3.000</i>	38.1	<i>1.500</i>	N/A	N/A	41.3	<i>1.625</i>	82.3	<i>3.240</i>
WV-762508-2.5-9	2,500	1	76.2	<i>3.000</i>	50.8	<i>2.000</i>	N/A	N/A	54.0	<i>2.125</i>	82.6	<i>3.240</i>
WV-762127-1-9	1,000	1	76.2	<i>3.000</i>	127.0	<i>5.000</i>	N/A	N/A	129.5	<i>5.100</i>	79.4	<i>3.130</i>
WV-101508-2.5-9	2,500	1	101.6	<i>4.000</i>	50.8	<i>2.000</i>	N/A	N/A	54.6	<i>2.150</i>	104.1	<i>4.100</i>
WV-101635-2.5-9	2,500	1	101.6	<i>4.000</i>	63.5	<i>2.500</i>	N/A	N/A	66.7	<i>2.625</i>	107.7	<i>4.240</i>
WV-101762-1.8-9	1,800	1	101.6	<i>4.000</i>	76.2	<i>3.000</i>	N/A	N/A	79.4	<i>3.125</i>	104.1	<i>4.100</i>
WV-101101-1.3-9	1,300	1	101.6	<i>4.000</i>	101.6	<i>4.000</i>	N/A	N/A	104.8	<i>4.125</i>	104.1	<i>4.100</i>
WV-101165-0.85-9	850	1	101.6	<i>4.000</i>	165.1	<i>6.500</i>	N/A	N/A	168.3	<i>6.680</i>	104.9	<i>4.130</i>



Electronics

Thermal Transfer

NC Nylon cloth labels

Tyco NC is a thermal transfer printable, flexible nylon cloth with a permanent acrylic adhesive, designed for application to irregular surfaces where conformability is required. It is ideal for wire marking and other round or flexible surfaces such as cables and tubing. NC is not recommended for outdoor use or immersion in liquid. For guaranteed print performance and durability, use with Tyco's RHD series ribbon.

Features and benefits

- Thermal transfer printable.
- Surface coating applied to enhance ink receptivity.
- Flexible material conforms to curved surfaces.
- Several die-cut sizes available.



<b>Adhesive</b>	Permanent acrylic
<b>Service temperature</b>	-40°C to +140°C -40°F to +284°F
<b>Recommended printer</b>	T308S*
<b>Recommended ribbon</b>	1330-0607-10*

\*Alternative printers and ribbons are available for special applications. Contact Tyco Electronics Identification for more information.

Part numbering system

NC-044033-10-9



Ordering information



Product dimensions

Product order code	Package quantity	Labels across	Label width (A)		Label height (B)		Horizontal repeat (C)		Vertical repeat (D)		Web width (E)	
			mm	<i>inches</i>	mm	<i>inches</i>	mm	<i>inches</i>	mm	<i>inches</i>	mm	<i>inches</i>
NC-044033-10-9	10,000	20	4.4	<i>0.170</i>	3.3	<i>0.130</i>	4.4	<i>0.170</i>	9.5	<i>0.375</i>	92.4	<i>3.636</i>
NC-064064-25-9	25,000	12	6.4	<i>0.250</i>	6.4	<i>0.250</i>	6.4	<i>0.250</i>	9.5	<i>0.375</i>	82.2	<i>3.240</i>
NC-076191-10-9	10,000	8	7.6	<i>0.300</i>	19.1	<i>0.750</i>	7.6	<i>0.300</i>	22.2	<i>0.875</i>	67.3	<i>2.650</i>
NC-080080-10-9	10,000	8	8.0	<i>0.315</i>	8.0	<i>0.315</i>	9.9	<i>0.390</i>	13.3	<i>0.525</i>	83.3	<i>3.280</i>
NC-095080-25-9	25,000	5	9.5	<i>0.375</i>	8.0	<i>0.315</i>	12.2	<i>0.480</i>	12.7	<i>0.500</i>	64.3	<i>2.531</i>
NC-095095-10-9	10,000	7	9.5	<i>0.375</i>	9.5	<i>0.375</i>	11.1	<i>0.437</i>	12.7	<i>0.500</i>	82.1	<i>3.230</i>
NC-127032-10-9	10,000	5	12.7	<i>0.500</i>	3.2	<i>0.125</i>	19.1	<i>0.750</i>	3.2	<i>0.250</i>	94.9	<i>3.736</i>
NC-127111-10-9	10,000	5	12.7	<i>0.500</i>	11.1	<i>0.437</i>	16.8	<i>0.662</i>	14.3	<i>0.563</i>	86.0	<i>3.380</i>
NC-127127-10-9	10,000	5	12.7	<i>0.500</i>	12.7	<i>0.500</i>	15.9	<i>0.625</i>	15.9	<i>0.625</i>	82.6	<i>3.250</i>
NC-165051-25-9	25,000	4	16.5	<i>0.650</i>	5.1	<i>0.200</i>	17.8	<i>0.700</i>	8.3	<i>0.325</i>	75.8	<i>2.990</i>
NC-178095-10-9	10,000	4	17.8	<i>0.700</i>	9.5	<i>0.375</i>	19.1	<i>0.750</i>	12.7	<i>0.500</i>	80.9	<i>3.190</i>
NC-191064-10-9	10,000	4	19.1	<i>0.750</i>	6.4	<i>0.250</i>	21.6	<i>0.850</i>	9.5	<i>0.375</i>	89.9	<i>3.540</i>
NC-191762-5-9	5,000	3	19.1	<i>0.750</i>	76.2	<i>3.000</i>	21.6	<i>0.850</i>	88.9	<i>3.500</i>	68.2	<i>2.686</i>
NC-229064-10-9	10,000	3	22.9	<i>0.900</i>	6.4	<i>0.250</i>	28.6	<i>1.125</i>	9.5	<i>0.375</i>	86.0	<i>3.390</i>
NC-250381-10-9	10,000	4	24.9	<i>0.980</i>	38.1	<i>1.500</i>	27.4	<i>1.080</i>	47.6	<i>1.875</i>	113.5	<i>4.470</i>
NC-254045-10-9	10,000	3	25.4	<i>1.000</i>	4.6	<i>0.180</i>	31.8	<i>1.250</i>	8.5	<i>0.333</i>	95.3	<i>3.750</i>
NC-254064-10-9	10,000	3	25.4	<i>1.000</i>	6.4	<i>0.250</i>	27.9	<i>1.100</i>	9.5	<i>0.375</i>	87.3	<i>3.436</i>
NC-254097-10-9	10,000	3	25.4	<i>1.000</i>	9.7	<i>0.380</i>	27.9	<i>1.100</i>	12.7	<i>0.500</i>	87.4	<i>3.440</i>
NC-254127-10-9	10,000	3	25.4	<i>1.000</i>	12.7	<i>0.500</i>	27.9	<i>1.100</i>	16.9	<i>0.666</i>	87.4	<i>3.440</i>
NC-254254-10-9	10,000	3	25.4	<i>1.000</i>	25.4	<i>1.000</i>	27.9	<i>1.100</i>	28.6	<i>1.125</i>	87.4	<i>3.440</i>
NC-305047-10-9	10,000	2	30.5	<i>1.200</i>	4.7	<i>0.185</i>	33.0	<i>1.300</i>	7.8	<i>0.306</i>	69.5	<i>2.736</i>
NC-318064-10-9	10,000	1	31.8	<i>1.250</i>	6.4	<i>0.250</i>	N/A	N/A	9.5	<i>0.375</i>	37.9	<i>1.490</i>
NC-381020-10-9	10,000	1	38.1	<i>1.500</i>	2.0	<i>0.080</i>	N/A	N/A	10.7	<i>0.423</i>	44.1	<i>1.740</i>
NC-381064-10-S1-9	10,000	1*	38.1	<i>1.500</i>	6.4	<i>0.250</i>	N/A	N/A	9.5	<i>0.375</i>	44.5	<i>1.750</i>
NC-381064-10-9	10,000	1	38.1	<i>1.500</i>	6.4	<i>0.250</i>	N/A	N/A	9.5	<i>0.375</i>	44.5	<i>1.750</i>
NC-381127-5-9	5,000	2	38.1	<i>1.500</i>	12.7	<i>0.500</i>	44.2	<i>1.738</i>	15.9	<i>0.625</i>	88.2	<i>3.472</i>
NC-381381-2.5-9	2,500	2	38.1	<i>1.500</i>	38.1	<i>1.500</i>	44.5	<i>1.750</i>	40.8	<i>1.607</i>	88.9	<i>3.500</i>
NC-381635-5-9	5,000	2	38.1	<i>1.500</i>	63.5	<i>2.500</i>	40.6	<i>1.600</i>	66.7	<i>2.625</i>	84.7	<i>3.336</i>
NC-445064-10-9	10,000	1	44.5	<i>1.750</i>	6.4	<i>0.250</i>	N/A	N/A	9.5	<i>0.375</i>	50.4	<i>1.986</i>
NC-445102-5-9	5,000	1	44.5	<i>1.750</i>	10.2	<i>0.400</i>	N/A	N/A	12.7	<i>0.500</i>	50.4	<i>1.986</i>
NC-445445-2-9	2,000	1	44.5	<i>1.750</i>	44.5	<i>1.750</i>	N/A	N/A	47.6	<i>1.875</i>	50.4	<i>1.986</i>
NC-508064-10-9	10,000	1	50.8	<i>2.000</i>	6.4	<i>0.250</i>	N/A	N/A	9.5	<i>0.375</i>	56.9	<i>2.240</i>
NC-508095-5-9	5,000	1	50.8	<i>2.000</i>	9.5	<i>0.375</i>	N/A	N/A	12.7	<i>0.500</i>	57.2	<i>2.250</i>
NC-508127-10-9	10,000	1	50.8	<i>2.000</i>	12.7	<i>0.500</i>	N/A	N/A	15.9	<i>0.625</i>	56.9	<i>2.240</i>
NC-508508-3-9	3,000	1	50.8	<i>2.000</i>	50.8	<i>2.000</i>	N/A	N/A	54.6	<i>2.150</i>	54.0	<i>2.130</i>
NC-523841-1.5-9	1,500	1	52.3	<i>2.060</i>	84.1	<i>3.310</i>	N/A	N/A	88.9	<i>3.500</i>	58.2	<i>2.290</i>

\*Perforated

Tyco polyimide (Kapton®) labels are all ideal for high temperature labeling requirements such as printed circuit boards. They are suitable for direct wave (bottom side) and IR reflow (top side) PCB applications. Tyco Kapton® labels are designed to withstand the fluxes, cleaning solvents and molten solder encountered in the manufacture of printed circuit boards. They offer excellent contrast for bar code applications. Tyco Kapton® labels are suitable for the harshest high temperature applications. For guaranteed print performance and durability, use with Tyco's RHT-45 series ribbon.

**Features and benefits**

- UL Listed.
- Thermal transfer printable.
- High temperature permanent acrylic adhesive.

**T1K**

- Gloss white topcoat.
- Withstands surface mount board processes on either the top or bottom side of the board.
- Low profile 1 mil film offers polyimide thermal performance at competitive cost.
- Ideal for manual apply applications.

**T2K**

- Gloss white topcoat.
- Withstands surface mount board processes on either the top or bottom side of the board.
- Ideal for auto apply applications.

**TAK**

- Gloss amber topcoat, for use where amber color is preferred.
- Withstands surface mount board processes on either the top or bottom side of the board.
- Ideal for auto apply applications.

**TSK**

- High opacity gloss white topcoat.
- Withstands surface mount board processes on either the top or bottom side of the board.
- Deemed to be a static safe product in accordance with EIA 625, EIA 541. Test methods employed were in accordance with EOS/ESD S11.11.
- Ideal for auto apply applications.

**T2Y**

- High opacity gloss white topcoat.
- Economic alternative to T1K material.
- Withstands surface mount board processes on either the top or bottom side of the board — can also be used on the top side of the board in mixed processes, *but it is not recommended for the bottom side which is directly exposed to the wave solder environment.*



**KTT**

- Matte tan topcoat.
- Withstands surface mount board processes on either the top or bottom side of the board.
- Product approved for aerospace/defense applications.
- Low outgassing.



<b>Adhesive</b>	Permanent acrylic	
<b>Service temperature</b>		
T1K <sup>1</sup> , T2K <sup>2</sup> , TAK <sup>2</sup> , TSK <sup>2</sup> , KTT <sup>2</sup>	-40°C to +260°C	-40°F to +500°F
T2Y <sup>3</sup>	-40°C to +232°C	-40°F to +450°F
	<sup>1</sup> Flash exposure to +472°C (+800°F)	
	<sup>2</sup> Flash exposure to +538°C (+1000°F)	
	<sup>3</sup> Flash exposure to +316°C (+600°F)	
<b>Recommended printer</b>		
T1k, T2K, TAK, TSK, T2Y T2Y, KTT	T312M*	
<b>Recommended ribbon</b>	1330-0619-10*	
	*Alternative printers and ribbons are available for special applications. Contact Tyco Electronics Identification for more information.	

**Part numbering system**

T1K-044033-10-9



**T1K White Kapton® labels**

Ordering information



Product dimensions

Product order code	Package quantity	Labels across	Label width (A)		Label height (B)		Horizontal repeat (C)		Vertical repeat (D)		Web width (E)	
			mm	<i>inches</i>	mm	<i>inches</i>	mm	<i>inches</i>	mm	<i>inches</i>	mm	<i>inches</i>
T1K-044033-10-9	10,000	20	4.4	<i>0.170</i>	3.3	<i>0.130</i>	4.4	<i>0.170</i>	9.5	<i>0.375</i>	92.4	<i>3.636</i>
T1K-064064-25-9	25,000	12	6.4	<i>0.250</i>	6.4	<i>0.250</i>	6.4	<i>0.250</i>	9.5	<i>0.375</i>	82.2	<i>3.240</i>
T1K-076191-10-9	10,000	8	7.6	<i>0.300</i>	19.1	<i>0.750</i>	7.6	<i>0.300</i>	22.2	<i>0.875</i>	67.3	<i>2.650</i>
T1K-080080-10-9	10,000	8	8.0	<i>0.315</i>	8.0	<i>0.315</i>	9.9	<i>0.390</i>	13.3	<i>0.525</i>	83.3	<i>3.280</i>
T1K-095080-25-9	25,000	5	9.5	<i>0.375</i>	8.0	<i>0.315</i>	12.2	<i>0.480</i>	12.7	<i>0.500</i>	64.3	<i>2.531</i>
T1K-095095-10-9	10,000	7	9.5	<i>0.375</i>	9.5	<i>0.375</i>	11.1	<i>0.437</i>	12.7	<i>0.500</i>	82.1	<i>3.230</i>
T1K-127032-10-9	10,000	5	12.7	<i>0.500</i>	3.2	<i>0.125</i>	19.1	<i>0.750</i>	3.2	<i>0.250</i>	94.9	<i>3.736</i>
T1K-127111-10-9	10,000	5	12.7	<i>0.500</i>	11.1	<i>0.437</i>	16.8	<i>0.662</i>	14.3	<i>0.563</i>	86.0	<i>3.380</i>
T1K-127127-10-9	10,000	5	12.7	<i>0.500</i>	12.7	<i>0.500</i>	15.9	<i>0.625</i>	15.9	<i>0.625</i>	82.6	<i>3.250</i>
T1K-165051-25-9	25,000	4	16.5	<i>0.650</i>	5.1	<i>0.200</i>	17.8	<i>0.700</i>	8.3	<i>0.325</i>	75.8	<i>2.990</i>
T1K-171171-10-9	10,000	5	17.1	<i>0.674</i>	17.1	<i>0.674</i>	19.7	<i>0.774</i>	20.3	<i>0.800</i>	101.8	<i>4.006</i>
T1K-178095-10-9	10,000	4	17.8	<i>0.700</i>	9.5	<i>0.375</i>	19.1	<i>0.750</i>	12.7	<i>0.500</i>	80.9	<i>3.190</i>
T1K-191064-10-9	10,000	4	19.1	<i>0.750</i>	6.4	<i>0.250</i>	21.6	<i>0.850</i>	9.5	<i>0.375</i>	89.9	<i>3.540</i>
T1K-191762-5-9	5,000	3	19.1	<i>0.750</i>	76.2	<i>3.000</i>	21.6	<i>0.850</i>	88.9	<i>3.500</i>	68.2	<i>2.686</i>
T1K-229064-10-9	10,000	3	22.9	<i>0.900</i>	6.4	<i>0.250</i>	28.6	<i>1.125</i>	9.5	<i>0.375</i>	86.0	<i>3.390</i>
T1K-250381-10-9	10,000	4	24.9	<i>0.980</i>	38.1	<i>1.500</i>	27.4	<i>1.080</i>	47.6	<i>1.875</i>	113.5	<i>4.470</i>
T1K-254045-10-9	10,000	3	25.4	<i>1.000</i>	4.6	<i>0.180</i>	31.8	<i>1.250</i>	8.5	<i>0.333</i>	95.3	<i>3.750</i>
T1K-254064-10-9	10,000	3	25.4	<i>1.000</i>	6.4	<i>0.250</i>	27.9	<i>1.100</i>	9.5	<i>0.375</i>	87.3	<i>3.436</i>
T1K-254097-10-9	10,000	3	25.4	<i>1.000</i>	9.7	<i>0.380</i>	27.9	<i>1.100</i>	12.7	<i>0.500</i>	87.4	<i>3.440</i>
T1K-254127-10-9	10,000	3	25.4	<i>1.000</i>	12.7	<i>0.500</i>	27.9	<i>1.100</i>	16.9	<i>0.666</i>	87.4	<i>3.440</i>
T1K-254254-10-9	10,000	3	25.4	<i>1.000</i>	25.4	<i>1.000</i>	27.9	<i>1.100</i>	28.6	<i>1.125</i>	87.4	<i>3.440</i>
T1K-305047-10-9	10,000	2	30.5	<i>1.200</i>	4.7	<i>0.185</i>	33.0	<i>1.300</i>	7.8	<i>0.306</i>	69.5	<i>2.736</i>
T1K-318064-10-9	10,000	1	31.8	<i>1.250</i>	6.4	<i>0.250</i>	N/A	N/A	9.5	<i>0.375</i>	37.9	<i>1.490</i>
T1K-381020-10-9	10,000	1	38.1	<i>1.500</i>	2.0	<i>0.080</i>	N/A	N/A	10.7	<i>0.423</i>	44.1	<i>1.740</i>
T1K-381127-5-9	5,000	2	38.1	<i>1.500</i>	12.7	<i>0.500</i>	44.2	<i>1.738</i>	15.9	<i>0.625</i>	88.2	<i>3.472</i>
T1K-381381-2.5-9	2,500	2	38.1	<i>1.500</i>	38.1	<i>1.500</i>	44.5	<i>1.750</i>	40.8	<i>1.607</i>	88.9	<i>3.500</i>
T1K-381635-5-9	5,000	2	38.1	<i>1.500</i>	63.5	<i>2.500</i>	40.6	<i>1.600</i>	66.7	<i>2.625</i>	84.7	<i>3.336</i>
T1K-445064-10-9	10,000	1	44.5	<i>1.750</i>	6.4	<i>0.250</i>	N/A	N/A	9.5	<i>0.375</i>	50.4	<i>1.986</i>
T1K-445102-5-9	5,000	1	44.5	<i>1.750</i>	10.2	<i>0.400</i>	N/A	N/A	12.7	<i>0.500</i>	50.4	<i>1.986</i>
T1K-445445-2-9	2,000	1	44.5	<i>1.750</i>	44.5	<i>1.750</i>	N/A	N/A	47.6	<i>1.875</i>	50.4	<i>1.986</i>
T1K-508064-10-9	10,000	1	50.8	<i>2.000</i>	6.4	<i>0.250</i>	N/A	N/A	9.5	<i>0.375</i>	56.9	<i>2.240</i>
T1K-508095-5-9	5,000	1	50.8	<i>2.000</i>	9.5	<i>0.375</i>	N/A	N/A	12.7	<i>0.500</i>	57.2	<i>2.250</i>
T1K-508127-10-9	10,000	1	50.8	<i>2.000</i>	12.7	<i>0.500</i>	N/A	N/A	15.9	<i>0.625</i>	56.9	<i>2.240</i>
T1K-508508-3-9	3,000	1	50.8	<i>2.000</i>	50.8	<i>2.000</i>	N/A	N/A	54.6	<i>2.150</i>	54.0	<i>2.130</i>
T1K-523841-1.5-9	1,500	1	52.3	<i>2.060</i>	84.1	<i>3.310</i>	N/A	N/A	88.9	<i>3.500</i>	58.2	<i>2.290</i>

**Ordering information**



**Product dimensions**

Product order code	Package quantity	Labels across	Label width (A)		Label height (B)		Horizontal repeat (C)		Vertical repeat (D)		Web width (E)	
			mm	<i>inches</i>	mm	<i>inches</i>	mm	<i>inches</i>	mm	<i>inches</i>	mm	<i>inches</i>
T2K-044033-10-9	10,000	20	4.4	<i>0.170</i>	3.3	<i>0.130</i>	4.4	<i>0.170</i>	9.5	<i>0.375</i>	92.4	<i>3.636</i>
T2K-064064-25-9	25,000	12	6.4	<i>0.250</i>	6.4	<i>0.250</i>	6.4	<i>0.250</i>	9.5	<i>0.375</i>	82.2	<i>3.240</i>
T2K-076191-10-9	10,000	8	7.6	<i>0.300</i>	19.1	<i>0.750</i>	7.6	<i>0.300</i>	22.2	<i>0.875</i>	67.3	<i>2.650</i>
T2K-080080-10-9	10,000	8	8.0	<i>0.315</i>	8.0	<i>0.315</i>	9.9	<i>0.390</i>	13.3	<i>0.525</i>	83.3	<i>3.280</i>
T2K-095080-25-9	25,000	5	9.5	<i>0.375</i>	8.0	<i>0.315</i>	12.2	<i>0.480</i>	12.7	<i>0.500</i>	64.3	<i>2.531</i>
T2K-095095-10-9	10,000	7	9.5	<i>0.375</i>	9.5	<i>0.375</i>	11.1	<i>0.437</i>	12.7	<i>0.500</i>	82.1	<i>3.230</i>
T2K-127032-10-9	10,000	5	12.7	<i>0.500</i>	3.2	<i>0.125</i>	19.1	<i>0.750</i>	3.2	<i>0.250</i>	94.9	<i>3.736</i>
T2K-127111-10-9	10,000	5	12.7	<i>0.500</i>	11.1	<i>0.437</i>	16.8	<i>0.662</i>	14.3	<i>0.563</i>	86.0	<i>3.380</i>
T2K-127127-10-9	10,000	5	12.7	<i>0.500</i>	12.7	<i>0.500</i>	15.9	<i>0.625</i>	15.9	<i>0.625</i>	82.6	<i>3.250</i>
T2K-165051-25-9	25,000	4	16.5	<i>0.650</i>	5.1	<i>0.200</i>	17.8	<i>0.700</i>	8.3	<i>0.325</i>	75.8	<i>2.990</i>
T2K-171171-10-9	10,000	5	17.1	<i>0.674</i>	17.1	<i>0.674</i>	19.7	<i>0.774</i>	20.3	<i>0.800</i>	101.8	<i>4.006</i>
T2K-178095-10-9	10,000	4	17.8	<i>0.700</i>	9.5	<i>0.375</i>	19.1	<i>0.750</i>	12.7	<i>0.500</i>	80.9	<i>3.190</i>
T2K-191064-10-9	10,000	4	19.1	<i>0.750</i>	6.4	<i>0.250</i>	21.6	<i>0.850</i>	9.5	<i>0.375</i>	89.9	<i>3.540</i>
T2K-191762-5-9	5,000	3	19.1	<i>0.750</i>	76.2	<i>3.000</i>	21.6	<i>0.850</i>	88.9	<i>3.500</i>	68.2	<i>2.686</i>
T2K-229064-10-9	10,000	3	22.9	<i>0.900</i>	6.4	<i>0.250</i>	28.6	<i>1.125</i>	9.5	<i>0.375</i>	86.0	<i>3.390</i>
T2K-250381-10-9	10,000	4	24.9	<i>0.980</i>	38.1	<i>1.500</i>	27.4	<i>1.080</i>	47.6	<i>1.875</i>	113.5	<i>4.470</i>
T2K-254045-10-9	10,000	3	25.4	<i>1.000</i>	4.6	<i>0.180</i>	31.8	<i>1.250</i>	8.5	<i>0.333</i>	95.3	<i>3.750</i>
T2K-254064-10-9	10,000	3	25.4	<i>1.000</i>	6.4	<i>0.250</i>	27.9	<i>1.100</i>	9.5	<i>0.375</i>	87.3	<i>3.436</i>
T2K-254097-10-9	10,000	3	25.4	<i>1.000</i>	9.7	<i>0.380</i>	27.9	<i>1.100</i>	12.7	<i>0.500</i>	87.4	<i>3.440</i>
T2K-254127-10-9	10,000	3	25.4	<i>1.000</i>	12.7	<i>0.500</i>	27.9	<i>1.100</i>	16.9	<i>0.666</i>	87.4	<i>3.440</i>
T2K-254254-10-9	10,000	3	25.4	<i>1.000</i>	25.4	<i>1.000</i>	27.9	<i>1.100</i>	28.6	<i>1.125</i>	87.4	<i>3.440</i>
T2K-305047-10-9	10,000	2	30.5	<i>1.200</i>	4.7	<i>0.185</i>	33.0	<i>1.300</i>	7.8	<i>0.306</i>	69.5	<i>2.736</i>
T2K-318064-10-9	10,000	1	31.8	<i>1.250</i>	6.4	<i>0.250</i>	N/A	N/A	9.5	<i>0.375</i>	37.9	<i>1.490</i>
T2K-381020-10-9	10,000	1	38.1	<i>1.500</i>	2.0	<i>0.080</i>	N/A	N/A	10.7	<i>0.423</i>	44.1	<i>1.740</i>
T2K-381064-10-9	10,000	1	38.1	<i>1.500</i>	6.4	<i>0.250</i>	N/A	N/A	9.5	<i>0.375</i>	44.5	<i>1.750</i>
T2K-381127-5-9	5,000	2	38.1	<i>1.500</i>	12.7	<i>0.500</i>	44.2	<i>1.738</i>	15.9	<i>0.625</i>	88.2	<i>3.472</i>
T2K-381381-2.5-9	2,500	2	38.1	<i>1.500</i>	38.1	<i>1.500</i>	44.5	<i>1.750</i>	40.8	<i>1.607</i>	88.9	<i>3.500</i>
T2K-381635-5-9	5,000	2	38.1	<i>1.500</i>	63.5	<i>2.500</i>	40.6	<i>1.600</i>	66.7	<i>2.625</i>	84.7	<i>3.336</i>
T2K-445064-10-9	10,000	1	44.5	<i>1.750</i>	6.4	<i>0.250</i>	N/A	N/A	9.5	<i>0.375</i>	50.4	<i>1.986</i>
T2K-445102-5-9	5,000	1	44.5	<i>1.750</i>	10.2	<i>0.400</i>	N/A	N/A	12.7	<i>0.500</i>	50.4	<i>1.986</i>
T2K-445445-2-9	2,000	1	44.5	<i>1.750</i>	44.5	<i>1.750</i>	N/A	N/A	47.6	<i>1.875</i>	50.4	<i>1.986</i>
T2K-508064-10-9	10,000	1	50.8	<i>2.000</i>	6.4	<i>0.250</i>	N/A	N/A	9.5	<i>0.375</i>	56.9	<i>2.240</i>
T2K-508095-5-9	5,000	1	50.8	<i>2.000</i>	9.5	<i>0.375</i>	N/A	N/A	12.7	<i>0.500</i>	57.2	<i>2.250</i>
T2K-508127-10-9	10,000	1	50.8	<i>2.000</i>	12.7	<i>0.500</i>	N/A	N/A	15.9	<i>0.625</i>	56.9	<i>2.240</i>
T2K-508508-3-9	3,000	1	50.8	<i>2.000</i>	50.8	<i>2.000</i>	N/A	N/A	54.6	<i>2.150</i>	54.0	<i>2.130</i>
T2K-523841-1.5-9	1,500	1	52.3	<i>2.060</i>	84.1	<i>3.310</i>	N/A	N/A	88.9	<i>3.500</i>	58.2	<i>2.290</i>

Ordering information



Product dimensions

Product order code	Package quantity	Labels across	Label width (A)		Label height (B)		Horizontal repeat (C)		Vertical repeat (D)		Web width (E)	
			mm	<i>inches</i>	mm	<i>inches</i>	mm	<i>inches</i>	mm	<i>inches</i>	mm	<i>inches</i>
TAK-044033-10-3A	10,000	20	4.4	<i>0.170</i>	3.3	<i>0.130</i>	4.4	<i>0.170</i>	9.5	<i>0.375</i>	92.4	<i>3.636</i>
TAK-064064-25-3A	25,000	12	6.4	<i>0.250</i>	6.4	<i>0.250</i>	6.4	<i>0.250</i>	9.5	<i>0.375</i>	82.2	<i>3.240</i>
TAK-076191-10-3A	10,000	8	7.6	<i>0.300</i>	19.1	<i>0.750</i>	7.6	<i>0.300</i>	22.2	<i>0.875</i>	67.3	<i>2.650</i>
TAK-080080-10-3A	10,000	8	8.0	<i>0.315</i>	8.0	<i>0.315</i>	9.9	<i>0.390</i>	13.3	<i>0.525</i>	83.3	<i>3.280</i>
TAK-095080-25-3A	25,000	5	9.5	<i>0.375</i>	8.0	<i>0.315</i>	12.2	<i>0.480</i>	12.7	<i>0.500</i>	64.3	<i>2.531</i>
TAK-095095-10-3A	10,000	7	9.5	<i>0.375</i>	9.5	<i>0.375</i>	11.1	<i>0.437</i>	12.7	<i>0.500</i>	82.1	<i>3.230</i>
TAK-127032-10-3A	10,000	5	12.7	<i>0.500</i>	3.2	<i>0.125</i>	19.1	<i>0.750</i>	3.2	<i>0.250</i>	94.9	<i>3.736</i>
TAK-127111-10-3A	10,000	5	12.7	<i>0.500</i>	11.1	<i>0.437</i>	16.8	<i>0.662</i>	14.3	<i>0.563</i>	86.0	<i>3.380</i>
TAK-127127-10-3A	10,000	5	12.7	<i>0.500</i>	12.7	<i>0.500</i>	15.9	<i>0.625</i>	15.9	<i>0.625</i>	82.6	<i>3.250</i>
TAK-165051-25-3A	25,000	4	16.5	<i>0.650</i>	5.1	<i>0.200</i>	17.8	<i>0.700</i>	8.3	<i>0.325</i>	75.8	<i>2.990</i>
TAK-171171-10-3A	10,000	5	17.1	<i>0.674</i>	17.1	<i>0.674</i>	19.7	<i>0.774</i>	20.3	<i>0.800</i>	101.8	<i>4.006</i>
TAK-178095-10-3A	10,000	4	17.8	<i>0.700</i>	9.5	<i>0.375</i>	19.1	<i>0.750</i>	12.7	<i>0.500</i>	80.9	<i>3.190</i>
TAK-191064-10-3A	10,000	4	19.1	<i>0.750</i>	6.4	<i>0.250</i>	21.6	<i>0.850</i>	9.5	<i>0.375</i>	89.9	<i>3.540</i>
TAK-191762-5-3A	5,000	3	19.1	<i>0.750</i>	76.2	<i>3.000</i>	21.6	<i>0.850</i>	88.9	<i>3.500</i>	68.2	<i>2.686</i>
TAK-229064-10-3A	10,000	3	22.9	<i>0.900</i>	6.4	<i>0.250</i>	28.6	<i>1.125</i>	9.5	<i>0.375</i>	86.0	<i>3.390</i>
TAK-250381-10-3A	10,000	4	24.9	<i>0.980</i>	38.1	<i>1.500</i>	27.4	<i>1.080</i>	47.6	<i>1.875</i>	113.5	<i>4.470</i>
TAK-254045-10-3A	10,000	3	25.4	<i>1.000</i>	4.6	<i>0.180</i>	31.8	<i>1.250</i>	8.5	<i>0.333</i>	95.3	<i>3.750</i>
TAK-254064-10-3A	10,000	3	25.4	<i>1.000</i>	6.4	<i>0.250</i>	27.9	<i>1.100</i>	9.5	<i>0.375</i>	87.3	<i>3.436</i>
TAK-254097-10-3A	10,000	3	25.4	<i>1.000</i>	9.7	<i>0.380</i>	27.9	<i>1.100</i>	12.7	<i>0.500</i>	87.4	<i>3.440</i>
TAK-254127-10-3A	10,000	3	25.4	<i>1.000</i>	12.7	<i>0.500</i>	27.9	<i>1.100</i>	16.9	<i>0.666</i>	87.4	<i>3.440</i>
TAK-254254-10-3A	10,000	3	25.4	<i>1.000</i>	25.4	<i>1.000</i>	27.9	<i>1.100</i>	28.6	<i>1.125</i>	87.4	<i>3.440</i>
TAK-305047-10-3A	10,000	2	30.5	<i>1.200</i>	4.7	<i>0.185</i>	33.0	<i>1.300</i>	7.8	<i>0.306</i>	69.5	<i>2.736</i>
TAK-318064-10-3A	10,000	1	31.8	<i>1.250</i>	6.4	<i>0.250</i>	N/A	N/A	9.5	<i>0.375</i>	37.9	<i>1.490</i>
TAK-381020-10-3A	10,000	1	38.1	<i>1.500</i>	2.0	<i>0.080</i>	N/A	N/A	10.7	<i>0.423</i>	44.1	<i>1.740</i>
TAK-381064-10-3A	10,000	1	38.1	<i>1.500</i>	6.4	<i>0.250</i>	N/A	N/A	9.5	<i>0.375</i>	44.5	<i>1.750</i>
TAK-381127-5-3A	5,000	2	38.1	<i>1.500</i>	12.7	<i>0.500</i>	44.2	<i>1.738</i>	15.9	<i>0.625</i>	88.2	<i>3.472</i>
TAK-381381-2.5-3A	2,500	2	38.1	<i>1.500</i>	38.1	<i>1.500</i>	44.5	<i>1.750</i>	40.8	<i>1.607</i>	88.9	<i>3.500</i>
TAK-381635-5-3A	5,000	2	38.1	<i>1.500</i>	63.5	<i>2.500</i>	40.6	<i>1.600</i>	66.7	<i>2.625</i>	84.7	<i>3.336</i>
TAK-445064-10-3A	10,000	1	44.5	<i>1.750</i>	6.4	<i>0.250</i>	N/A	N/A	9.5	<i>0.375</i>	50.4	<i>1.986</i>
TAK-445102-5-3A	5,000	1	44.5	<i>1.750</i>	10.2	<i>0.400</i>	N/A	N/A	12.7	<i>0.500</i>	50.4	<i>1.986</i>
TAK-445445-2-3A	2,000	1	44.5	<i>1.750</i>	44.5	<i>1.750</i>	N/A	N/A	47.6	<i>1.875</i>	50.4	<i>1.986</i>
TAK-508064-10-3A	10,000	1	50.8	<i>2.000</i>	6.4	<i>0.250</i>	N/A	N/A	9.5	<i>0.375</i>	56.9	<i>2.240</i>
TAK-508095-5-3A	5,000	1	50.8	<i>2.000</i>	9.5	<i>0.375</i>	N/A	N/A	12.7	<i>0.500</i>	57.2	<i>2.250</i>
TAK-508127-10-3A	10,000	1	50.8	<i>2.000</i>	12.7	<i>0.500</i>	N/A	N/A	15.9	<i>0.625</i>	56.9	<i>2.240</i>
TAK-508508-3-3A	3,000	1	50.8	<i>2.000</i>	50.8	<i>2.000</i>	N/A	N/A	54.6	<i>2.150</i>	54.0	<i>2.130</i>
TAK-523841-1.5-3A	1,500	1	52.3	<i>2.060</i>	84.1	<i>3.310</i>	N/A	N/A	88.9	<i>3.500</i>	58.2	<i>2.290</i>

**Ordering information**



**Product dimensions**

Product order code	Package quantity	Labels across	Label width (A)		Label height (B)		Horizontal repeat (C)		Vertical repeat (D)		Web width (E)	
			mm	<i>inches</i>	mm	<i>inches</i>	mm	<i>inches</i>	mm	<i>inches</i>	mm	<i>inches</i>
TSK-044033-10-9	10,000	20	4.4	<i>0.170</i>	3.3	<i>0.130</i>	4.4	<i>0.170</i>	9.5	<i>0.375</i>	92.4	<i>3.636</i>
TSK-064064-25-9	25,000	12	6.4	<i>0.250</i>	6.4	<i>0.250</i>	6.4	<i>0.250</i>	9.5	<i>0.375</i>	82.2	<i>3.240</i>
TSK-076191-10-9	10,000	8	7.6	<i>0.300</i>	19.1	<i>0.750</i>	7.6	<i>0.300</i>	22.2	<i>0.875</i>	67.3	<i>2.650</i>
TSK-080080-10-9	10,000	8	8.0	<i>0.315</i>	8.0	<i>0.315</i>	9.9	<i>0.390</i>	13.3	<i>0.525</i>	83.3	<i>3.280</i>
TSK-095080-25-9	25,000	5	9.5	<i>0.375</i>	8.0	<i>0.315</i>	12.2	<i>0.480</i>	12.7	<i>0.500</i>	64.3	<i>2.531</i>
TSK-095095-10-9	10,000	7	9.5	<i>0.375</i>	9.5	<i>0.375</i>	11.1	<i>0.437</i>	12.7	<i>0.500</i>	82.1	<i>3.230</i>
TSK-127032-10-9	10,000	5	12.7	<i>0.500</i>	3.2	<i>0.125</i>	19.1	<i>0.750</i>	3.2	<i>0.250</i>	94.9	<i>3.736</i>
TSK-127111-10-9	10,000	5	12.7	<i>0.500</i>	11.1	<i>0.437</i>	16.8	<i>0.662</i>	14.3	<i>0.563</i>	86.0	<i>3.380</i>
TSK-127127-10-9	10,000	5	12.7	<i>0.500</i>	12.7	<i>0.500</i>	15.9	<i>0.625</i>	15.9	<i>0.625</i>	82.6	<i>3.250</i>
TSK-165051-25-9	25,000	4	16.5	<i>0.650</i>	5.1	<i>0.200</i>	17.8	<i>0.700</i>	8.3	<i>0.325</i>	75.8	<i>2.990</i>
TSK-171171-10-9	10,000	5	17.1	<i>0.674</i>	17.1	<i>0.674</i>	19.7	<i>0.774</i>	20.3	<i>0.800</i>	101.8	<i>4.006</i>
TSK-178095-10-9	10,000	4	17.8	<i>0.700</i>	9.5	<i>0.375</i>	19.1	<i>0.750</i>	12.7	<i>0.500</i>	80.9	<i>3.190</i>
TSK-191064-10-9	10,000	4	19.1	<i>0.750</i>	6.4	<i>0.250</i>	21.6	<i>0.850</i>	9.5	<i>0.375</i>	89.9	<i>3.540</i>
TSK-191762-5-9	5,000	3	19.1	<i>0.750</i>	76.2	<i>3.000</i>	21.6	<i>0.850</i>	88.9	<i>3.500</i>	68.2	<i>2.686</i>
TSK-229064-10-9	10,000	3	22.9	<i>0.900</i>	6.4	<i>0.250</i>	28.6	<i>1.125</i>	9.5	<i>0.375</i>	86.0	<i>3.390</i>
TSK-250381-10-9	10,000	4	24.9	<i>0.980</i>	38.1	<i>1.500</i>	27.4	<i>1.080</i>	47.6	<i>1.875</i>	113.5	<i>4.470</i>
TSK-254045-10-9	10,000	3	25.4	<i>1.000</i>	4.6	<i>0.180</i>	31.8	<i>1.250</i>	8.5	<i>0.333</i>	95.3	<i>3.750</i>
TSK-254064-10-9	10,000	3	25.4	<i>1.000</i>	6.4	<i>0.250</i>	27.9	<i>1.100</i>	9.5	<i>0.375</i>	87.3	<i>3.436</i>
TSK-254097-10-9	10,000	3	25.4	<i>1.000</i>	9.7	<i>0.380</i>	27.9	<i>1.100</i>	12.7	<i>0.500</i>	87.4	<i>3.440</i>
TSK-254127-10-9	10,000	3	25.4	<i>1.000</i>	12.7	<i>0.500</i>	27.9	<i>1.100</i>	16.9	<i>0.666</i>	87.4	<i>3.440</i>
TSK-254254-10-9	10,000	3	25.4	<i>1.000</i>	25.4	<i>1.000</i>	27.9	<i>1.100</i>	28.6	<i>1.125</i>	87.4	<i>3.440</i>
TSK-305047-10-9	10,000	2	30.5	<i>1.200</i>	4.7	<i>0.185</i>	33.0	<i>1.300</i>	7.8	<i>0.306</i>	69.5	<i>2.736</i>
TSK-318064-10-9	10,000	1	31.8	<i>1.250</i>	6.4	<i>0.250</i>	N/A	N/A	9.5	<i>0.375</i>	37.9	<i>1.490</i>
TSK-381020-10-9	10,000	1	38.1	<i>1.500</i>	2.0	<i>0.080</i>	N/A	N/A	10.7	<i>0.423</i>	44.1	<i>1.740</i>
TSK-381064-10-9	10,000	1	38.1	<i>1.500</i>	6.4	<i>0.250</i>	N/A	N/A	9.5	<i>0.375</i>	44.5	<i>1.750</i>
TSK-381127-5-9	5,000	2	38.1	<i>1.500</i>	12.7	<i>0.500</i>	44.2	<i>1.738</i>	15.9	<i>0.625</i>	88.2	<i>3.472</i>
TSK-381381-2.5-9	2,500	2	38.1	<i>1.500</i>	38.1	<i>1.500</i>	44.5	<i>1.750</i>	40.8	<i>1.607</i>	88.9	<i>3.500</i>
TSK-381635-5-9	5,000	2	38.1	<i>1.500</i>	63.5	<i>2.500</i>	40.6	<i>1.600</i>	66.7	<i>2.625</i>	84.7	<i>3.336</i>
TSK-445064-10-9	10,000	1	44.5	<i>1.750</i>	6.4	<i>0.250</i>	N/A	N/A	9.5	<i>0.375</i>	50.4	<i>1.986</i>
TSK-445102-5-9	5,000	1	44.5	<i>1.750</i>	10.2	<i>0.400</i>	N/A	N/A	12.7	<i>0.500</i>	50.4	<i>1.986</i>
TSK-445445-2-9	2,000	1	44.5	<i>1.750</i>	44.5	<i>1.750</i>	N/A	N/A	47.6	<i>1.875</i>	50.4	<i>1.986</i>
TSK-508064-10-9	10,000	1	50.8	<i>2.000</i>	6.4	<i>0.250</i>	N/A	N/A	9.5	<i>0.375</i>	56.9	<i>2.240</i>
TSK-508095-5-9	5,000	1	50.8	<i>2.000</i>	9.5	<i>0.375</i>	N/A	N/A	12.7	<i>0.500</i>	57.2	<i>2.250</i>
TSK-508127-10-9	10,000	1	50.8	<i>2.000</i>	12.7	<i>0.500</i>	N/A	N/A	15.9	<i>0.625</i>	56.9	<i>2.240</i>
TSK-508508-3-9	3,000	1	50.8	<i>2.000</i>	50.8	<i>2.000</i>	N/A	N/A	54.6	<i>2.150</i>	54.0	<i>2.130</i>
TSK-523841-1.5-9	1,500	1	52.3	<i>2.060</i>	84.1	<i>3.310</i>	N/A	N/A	88.9	<i>3.500</i>	58.2	<i>2.290</i>



**T2Y White modified polyimide film labels**

Ordering information



Product dimensions

Product order code	Package quantity	Labels across	Label width (A)		Label height (B)		Horizontal repeat (C)		Vertical repeat (D)		Web width (E)	
			mm	<i>inches</i>	mm	<i>inches</i>	mm	<i>inches</i>	mm	<i>inches</i>	mm	<i>inches</i>
T2Y-044033-10-9	10,000	20	4.4	<i>0.170</i>	3.3	<i>0.130</i>	4.4	<i>0.170</i>	9.5	<i>0.375</i>	92.4	<i>3.636</i>
T2Y-064064-25-9	25,000	12	6.4	<i>0.250</i>	6.4	<i>0.250</i>	6.4	<i>0.250</i>	9.5	<i>0.375</i>	82.2	<i>3.240</i>
T2Y-076191-10-9	10,000	8	7.6	<i>0.300</i>	19.1	<i>0.750</i>	7.6	<i>0.300</i>	22.2	<i>0.875</i>	67.3	<i>2.650</i>
T2Y-080080-10-9	10,000	8	8.0	<i>0.315</i>	8.0	<i>0.315</i>	9.9	<i>0.390</i>	13.3	<i>0.525</i>	83.3	<i>3.280</i>
T2Y-095080-25-9	25,000	5	9.5	<i>0.375</i>	8.0	<i>0.315</i>	12.2	<i>0.480</i>	12.7	<i>0.500</i>	64.3	<i>2.531</i>
T2Y-095095-10-9	10,000	7	9.5	<i>0.375</i>	9.5	<i>0.375</i>	11.1	<i>0.437</i>	12.7	<i>0.500</i>	82.1	<i>3.230</i>
T2Y-127032-10-9	10,000	5	12.7	<i>0.500</i>	3.2	<i>0.125</i>	19.1	<i>0.750</i>	3.2	<i>0.250</i>	94.9	<i>3.736</i>
T2Y-127111-10-9	10,000	5	12.7	<i>0.500</i>	11.1	<i>0.437</i>	16.8	<i>0.662</i>	14.3	<i>0.563</i>	86.0	<i>3.380</i>
T2Y-127127-10-9	10,000	5	12.7	<i>0.500</i>	12.7	<i>0.500</i>	15.9	<i>0.625</i>	15.9	<i>0.625</i>	82.6	<i>3.250</i>
T2Y-165051-25-9	25,000	4	16.5	<i>0.650</i>	5.1	<i>0.200</i>	17.8	<i>0.700</i>	8.3	<i>0.325</i>	75.8	<i>2.990</i>
T2Y-171171-10-9	10,000	5	17.1	<i>0.674</i>	17.1	<i>0.674</i>	19.7	<i>0.774</i>	20.3	<i>0.800</i>	101.8	<i>4.006</i>
T2Y-178095-10-9	10,000	4	17.8	<i>0.700</i>	9.5	<i>0.375</i>	19.1	<i>0.750</i>	12.7	<i>0.500</i>	80.9	<i>3.190</i>
T2Y-191064-10-9	10,000	4	19.1	<i>0.750</i>	6.4	<i>0.250</i>	21.6	<i>0.850</i>	9.5	<i>0.375</i>	89.9	<i>3.540</i>
T2Y-191762-5-9	5,000	3	19.1	<i>0.750</i>	76.2	<i>3.000</i>	21.6	<i>0.850</i>	88.9	<i>3.500</i>	68.2	<i>2.686</i>
T2Y-229064-10-9	10,000	3	22.9	<i>0.900</i>	6.4	<i>0.250</i>	28.6	<i>1.125</i>	9.5	<i>0.375</i>	86.0	<i>3.390</i>
T2Y-250381-10-9	10,000	4	24.9	<i>0.980</i>	38.1	<i>1.500</i>	27.4	<i>1.080</i>	47.6	<i>1.875</i>	113.5	<i>4.470</i>
T2Y-254045-10-9	10,000	3	25.4	<i>1.000</i>	4.6	<i>0.180</i>	31.8	<i>1.250</i>	8.5	<i>0.333</i>	95.3	<i>3.750</i>
T2Y-254064-10-9	10,000	3	25.4	<i>1.000</i>	6.4	<i>0.250</i>	27.9	<i>1.100</i>	9.5	<i>0.375</i>	87.3	<i>3.436</i>
T2Y-254097-10-9	10,000	3	25.4	<i>1.000</i>	9.7	<i>0.380</i>	27.9	<i>1.100</i>	12.7	<i>0.500</i>	87.4	<i>3.440</i>
T2Y-254127-10-9	10,000	3	25.4	<i>1.000</i>	12.7	<i>0.500</i>	27.9	<i>1.100</i>	16.9	<i>0.666</i>	87.4	<i>3.440</i>
T2Y-254254-10-9	10,000	3	25.4	<i>1.000</i>	25.4	<i>1.000</i>	27.9	<i>1.100</i>	28.6	<i>1.125</i>	87.4	<i>3.440</i>
T2Y-305047-10-9	10,000	2	30.5	<i>1.200</i>	4.7	<i>0.185</i>	33.0	<i>1.300</i>	7.8	<i>0.306</i>	69.5	<i>2.736</i>
T2Y-318064-10-9	10,000	1	31.8	<i>1.250</i>	6.4	<i>0.250</i>	N/A	N/A	9.5	<i>0.375</i>	37.9	<i>1.490</i>
T2Y-381020-10-9	10,000	1	38.1	<i>1.500</i>	2.0	<i>0.080</i>	N/A	N/A	10.7	<i>0.423</i>	44.1	<i>1.740</i>
T2Y-381064-10-9	10,000	1	38.1	<i>1.500</i>	6.4	<i>0.250</i>	N/A	N/A	9.5	<i>0.375</i>	44.5	<i>1.750</i>
T2Y-381127-5-9	5,000	2	38.1	<i>1.500</i>	12.7	<i>0.500</i>	44.2	<i>1.738</i>	15.9	<i>0.625</i>	88.2	<i>3.472</i>
T2Y-381381-2.5-9	2,500	2	38.1	<i>1.500</i>	38.1	<i>1.500</i>	44.5	<i>1.750</i>	40.8	<i>1.607</i>	88.9	<i>3.500</i>
T2Y-381635-5-9	5,000	2	38.1	<i>1.500</i>	63.5	<i>2.500</i>	40.6	<i>1.600</i>	66.7	<i>2.625</i>	84.7	<i>3.336</i>
T2Y-445064-10-9	10,000	1	44.5	<i>1.750</i>	6.4	<i>0.250</i>	N/A	N/A	9.5	<i>0.375</i>	50.4	<i>1.986</i>
T2Y-445102-5-9	5,000	1	44.5	<i>1.750</i>	10.2	<i>0.400</i>	N/A	N/A	12.7	<i>0.500</i>	50.4	<i>1.986</i>
T2Y-445445-2-9	2,000	1	44.5	<i>1.750</i>	44.5	<i>1.750</i>	N/A	N/A	47.6	<i>1.875</i>	50.4	<i>1.986</i>
T2Y-508064-10-9	10,000	1	50.8	<i>2.000</i>	6.4	<i>0.250</i>	N/A	N/A	9.5	<i>0.375</i>	56.9	<i>2.240</i>
T2Y-508095-5-9	5,000	1	50.8	<i>2.000</i>	9.5	<i>0.375</i>	N/A	N/A	12.7	<i>0.500</i>	57.2	<i>2.250</i>
T2Y-508127-10-9	10,000	1	50.8	<i>2.000</i>	12.7	<i>0.500</i>	N/A	N/A	15.9	<i>0.625</i>	56.9	<i>2.240</i>
T2Y-508508-3-9	3,000	1	50.8	<i>2.000</i>	50.8	<i>2.000</i>	N/A	N/A	54.6	<i>2.150</i>	54.0	<i>2.130</i>
T2Y-523841-1.5-9	1,500	1	52.3	<i>2.060</i>	84.1	<i>3.310</i>	N/A	N/A	88.9	<i>3.500</i>	58.2	<i>2.290</i>

**Ordering information**



**Product dimensions**

Product order code	Package quantity	Labels across	Label width (A)		Label height (B)		Horizontal repeat (C)		Vertical repeat (D)		Web width (E)	
			mm	<i>inches</i>	mm	<i>inches</i>	mm	<i>inches</i>	mm	<i>inches</i>	mm	<i>inches</i>
KTT-044033-10-1A	10,000	20	0.170	4.4	0.130	3.3	0.170	4.4	0.375	9.5	3.636	92.4
KTT-064064-25-1A	25,000	12	0.250	6.4	0.250	6.4	0.250	6.4	0.375	9.5	3.240	82.2
KTT-076191-10-1A	10,000	8	0.300	7.6	0.750	19.1	0.300	7.6	0.875	22.2	2.650	67.3
KTT-080080-10-1A	10,000	8	0.315	8.0	0.315	8.0	0.390	9.9	0.525	13.3	3.280	83.3
KTT-095080-25-1A	25,000	5	0.375	9.5	0.315	8.0	0.480	12.2	0.500	12.7	2.531	64.3
KTT-095095-10-1A	10,000	7	0.375	9.5	0.375	9.5	0.437	11.1	0.500	12.7	3.230	82.1
KTT-127032-10-1A	10,000	5	0.500	12.7	0.125	3.2	0.750	19.1	0.250	3.2	3.736	94.9
KTT-127111-10-1A	10,000	5	0.500	12.7	0.437	11.1	0.662	16.8	0.563	14.3	3.380	86.0
KTT-127127-10-1A	10,000	5	0.500	12.7	0.500	12.7	0.625	15.9	0.625	15.9	3.250	82.6
KTT-165051-25-1A	25,000	4	0.650	16.5	0.200	5.1	0.700	17.8	0.325	8.3	2.990	75.8
KTT-171171-10-1A	10,000	5	0.674	17.1	0.674	17.1	0.774	19.7	0.800	20.3	4.006	101.8
KTT-178095-10-1A	10,000	4	0.700	17.8	0.375	9.5	0.750	19.1	0.500	12.7	3.190	80.9
KTT-191064-10-1A	10,000	4	0.750	19.1	0.250	6.4	0.850	21.6	0.375	9.5	3.540	89.9
KTT-191762-5-1A	5,000	3	0.750	19.1	3.000	76.2	0.850	21.6	3.500	88.9	2.686	68.2
KTT-229064-10-1A	10,000	3	0.900	22.9	0.250	6.4	1.125	28.6	0.375	9.5	3.390	86.0
KTT-250381-10-1A	10,000	4	0.980	24.9	1.500	38.1	1.080	27.4	1.875	47.6	4.470	113.5
KTT-254045-10-1A	10,000	3	1.000	25.4	0.180	4.6	1.250	31.8	0.333	8.5	3.750	95.3
KTT-254064-10-1A	10,000	3	1.000	25.4	0.250	6.4	1.100	27.9	0.375	9.5	3.436	87.3
KTT-254097-10-1A	10,000	3	1.000	25.4	0.380	9.7	1.100	27.9	0.500	12.7	3.440	87.4
KTT-254127-10-1A	10,000	3	1.000	25.4	0.500	12.7	1.100	27.9	0.666	16.9	3.440	87.4
KTT-254254-10-1A	10,000	3	1.000	25.4	1.000	25.4	1.100	27.9	1.125	28.6	3.440	87.4
KTT-305047-10-1A	10,000	2	1.200	30.5	0.185	4.7	1.300	33.0	0.306	7.8	2.736	69.5
KTT-318064-10-1A	10,000	1	1.250	31.8	0.250	6.4	N/A	N/A	0.375	9.5	1.490	37.9
KTT-381020-10-1A	10,000	1	1.500	38.1	0.080	2.0	N/A	N/A	0.423	10.7	1.740	44.1
KTT-381064-10-1A	10,000	1	1.500	38.1	0.250	6.4	N/A	N/A	0.375	9.5	1.750	44.5
KTT-381127-5-1A	5,000	2	1.500	38.1	0.500	12.7	1.738	44.2	0.625	15.9	3.472	88.2
KTT-381381-2.5-1A	2,500	2	1.500	38.1	1.500	38.1	1.750	44.5	1.607	40.8	3.500	88.9
KTT-381635-5-1A	5,000	2	1.500	38.1	2.500	63.5	1.600	40.6	2.625	66.7	3.336	84.7
KTT-445064-10-1A	10,000	1	1.750	44.5	0.250	6.4	N/A	N/A	0.375	9.5	1.986	50.4
KTT-445102-5-1A	5,000	1	1.750	44.5	0.400	10.2	N/A	N/A	0.500	12.7	1.986	50.4
KTT-445445-2-1A	2,000	1	1.750	44.5	1.750	44.5	N/A	N/A	1.875	47.6	1.986	50.4
KTT-508064-10-1A	10,000	1	2.000	50.8	0.250	6.4	N/A	N/A	0.375	9.5	2.240	56.9
KTT-508095-5-1A	5,000	1	2.000	50.8	0.375	9.5	N/A	N/A	0.500	12.7	2.250	57.2
KTT-508127-10-1A	10,000	1	2.000	50.8	0.500	12.7	N/A	N/A	0.625	15.9	2.240	56.9
KTT-508508-3-1A	3,000	1	2.000	50.8	2.000	50.8	N/A	N/A	2.150	54.6	2.130	54.0
KTT-523841-1.5-1A	1,500	1	2.060	52.3	3.310	84.1	N/A	N/A	3.500	88.9	2.290	58.2



**PVF Polyvinylfluoride labels**

Tyco PVF is a thermal transfer printable polyvinylfluoride (Tedlar®) film with a permanent acrylic adhesive, designed for wire and cable marking and other general labeling applications that require the “self-extinguishing” properties of Tedlar®. It is ideal in a variety of harsh physical and chemical environments; resists water, oil, cleaning agents and oil based solvents; and filters ultraviolet light. For guaranteed print performance and durability use with Tyco’s 3300 series ribbon.

**Features and benefits**

- Thermal transfer printable.
- Ideal for wire and cable marking.
- Self-extinguishing adhesive.
- Resistant to a variety of solvents.



<b>Adhesive</b>	Permanent acrylic
<b>Service temperature</b>	-40°C to +130°C    -40°F to +266°F
<b>Recommended printer</b>	T308S*
<b>Recommended ribbon</b>	1330-3300-10*

\*Alternative printers and ribbons are available for special applications. Contact Tyco Electronics Identification for more information.



**Part numbering system**



**Ordering information**



**Product dimensions**

Product order code*	Package quantity	Labels across	Label width (A)		Label height (B)		Horizontal repeat (C)		Vertical repeat (D)		Web width (E)	
			mm	<i>inches</i>	mm	<i>inches</i>	mm	<i>inches</i>	mm	<i>inches</i>	mm	<i>inches</i>
PVF-040040-25-9	25,000	20	4.0	<i>0.157</i>	4.0	<i>0.157</i>	4.0	<i>0.157</i>	7.2	<i>0.281</i>	86.0	<i>3.380</i>
PVF-044033-10-9	10,000	20	4.4	<i>0.170</i>	3.3	<i>0.130</i>	4.4	<i>0.170</i>	9.5	<i>0.375</i>	92.4	<i>3.636</i>
PVF-064064-25-9	25,000	12	6.4	<i>0.250</i>	6.4	<i>0.250</i>	6.4	<i>0.250</i>	9.5	<i>0.375</i>	82.2	<i>3.240</i>
PVF-080080-10-9	10,000	8	8.0	<i>0.315</i>	8.0	<i>0.315</i>	9.9	<i>0.390</i>	13.3	<i>0.525</i>	83.3	<i>3.280</i>
PVF-089047-10-9	10,000	5	8.9	<i>0.350</i>	4.7	<i>0.185</i>	11.4	<i>0.450</i>	7.9	<i>0.313</i>	60.6	<i>2.386</i>
PVF-095080-25-9	25,000	5	9.5	<i>0.375</i>	8.0	<i>0.315</i>	12.2	<i>0.480</i>	12.7	<i>0.500</i>	64.3	<i>2.531</i>
PVF-095095-10-9	10,000	7	9.5	<i>0.375</i>	9.5	<i>0.375</i>	11.1	<i>0.437</i>	12.7	<i>0.500</i>	82.1	<i>3.230</i>
PVF-114040-25-9	25,000	6	11.4	<i>0.450</i>	4.0	<i>0.157</i>	11.4	<i>0.450</i>	7.2	<i>0.281</i>	74.6	<i>2.940</i>
PVF-127032-10-9	10,000	5	12.7	<i>0.500</i>	3.2	<i>0.125</i>	19.1	<i>0.750</i>	3.2	<i>0.250</i>	94.9	<i>3.736</i>

(continued)    \*Replace -9 suffix with -4 for yellow labels

**Product dimensions (continued)**

Product order code*	Package quantity	Labels across	Label width (A)		Label height (B)		Horizontal repeat (C)		Vertical repeat (D)		Web width (E)	
			mm	<i>inches</i>	mm	<i>inches</i>	mm	<i>inches</i>	mm	<i>inches</i>	mm	<i>inches</i>
PVF-127111-10-9	10,000	5	12.7	<i>0.500</i>	11.1	<i>0.437</i>	16.8	<i>0.662</i>	14.3	<i>0.563</i>	86.0	<i>3.380</i>
PVF-127127-10-9	10,000	5	12.7	<i>0.500</i>	12.7	<i>0.500</i>	15.9	<i>0.625</i>	15.9	<i>0.625</i>	82.6	<i>3.250</i>
PVF-165051-25-9	25,000	4	16.5	<i>0.650</i>	5.1	<i>0.200</i>	17.8	<i>0.700</i>	8.3	<i>0.325</i>	75.8	<i>2.990</i>
PVF-165102-10-9	10,000	5	16.5	<i>0.650</i>	10.2	<i>0.400</i>	19.1	<i>0.750</i>	13.8	<i>0.545</i>	99.1	<i>3.900</i>
PVF-171171-10-9	10,000	5	17.1	<i>0.674</i>	17.1	<i>0.674</i>	19.7	<i>0.774</i>	20.3	<i>0.800</i>	101.8	<i>4.006</i>
PVF-178095-10-9	10,000	4	17.8	<i>0.700</i>	9.5	<i>0.375</i>	19.1	<i>0.750</i>	12.7	<i>0.500</i>	80.9	<i>3.190</i>
PVF-191064-10-9	10,000	4	19.1	<i>0.750</i>	6.4	<i>0.250</i>	21.6	<i>0.850</i>	9.5	<i>0.375</i>	89.9	<i>3.540</i>
PVF-191114-15-9	15,000	3	19.1	<i>0.750</i>	11.4	<i>0.450</i>	22.2	<i>0.875</i>	14.7	<i>0.579</i>	69.5	<i>2.736</i>
PVF-191762-5-9	5,000	3	19.1	<i>0.750</i>	76.2	<i>3.000</i>	21.6	<i>0.850</i>	88.9	<i>3.500</i>	68.2	<i>2.686</i>
PVF-203127-10-9	10,000	4	20.3	<i>0.800</i>	12.7	<i>0.500</i>	22.9	<i>0.900</i>	15.9	<i>0.625</i>	94.6	<i>3.730</i>
PVF-208086-5-9	5,000	4	20.8	<i>0.820</i>	8.6	<i>0.340</i>	24.1	<i>0.950</i>	12.7	<i>0.500</i>	101.6	<i>4.000</i>
PVF-222159-15-9	15,000	2	22.2	<i>0.875</i>	15.9	<i>0.625</i>	24.8	<i>0.975</i>	19.1	<i>0.750</i>	53.0	<i>2.086</i>
PVF-229064-10-9	10,000	3	22.9	<i>0.900</i>	6.4	<i>0.250</i>	28.6	<i>1.125</i>	9.5	<i>0.375</i>	86.0	<i>3.390</i>
PVF-250381-10-9	10,000	4	24.9	<i>0.980</i>	38.1	<i>1.500</i>	27.4	<i>1.080</i>	47.6	<i>1.875</i>	113.5	<i>4.470</i>
PVF-254045-10-9	10,000	3	25.4	<i>1.000</i>	4.6	<i>0.180</i>	31.8	<i>1.250</i>	8.5	<i>0.333</i>	95.3	<i>3.750</i>
PVF-254064-10-9	10,000	3	25.4	<i>1.000</i>	6.4	<i>0.250</i>	27.9	<i>1.100</i>	9.5	<i>0.375</i>	87.3	<i>3.436</i>
PVF-254097-10-9	10,000	3	25.4	<i>1.000</i>	9.7	<i>0.380</i>	27.9	<i>1.100</i>	12.7	<i>0.500</i>	87.4	<i>3.440</i>
PVF-254127-10-9	10,000	3	25.4	<i>1.000</i>	12.7	<i>0.500</i>	27.9	<i>1.100</i>	16.9	<i>0.666</i>	87.4	<i>3.440</i>
PVF-254254-10-9	10,000	3	25.4	<i>1.000</i>	25.4	<i>1.000</i>	27.9	<i>1.100</i>	28.6	<i>1.125</i>	87.4	<i>3.440</i>
PVF-305047-10-9	10,000	2	30.5	<i>1.200</i>	4.7	<i>0.185</i>	33.0	<i>1.300</i>	7.8	<i>0.306</i>	69.5	<i>2.736</i>
PVF-318064-10-9	10,000	1	31.8	<i>1.250</i>	6.4	<i>0.250</i>	N/A	N/A	9.5	<i>0.375</i>	37.9	<i>1.490</i>
PVF-318097-10-9	10,000	1	31.8	<i>1.250</i>	9.7	<i>0.380</i>	N/A	N/A	12.7	<i>0.500</i>	37.8	<i>1.488</i>
PVF-381020-10-9	10,000	1	38.1	<i>1.500</i>	2.0	<i>0.080</i>	N/A	N/A	10.7	<i>0.423</i>	44.1	<i>1.740</i>
PVF-381064-10-9	10,000	1	38.1	<i>1.500</i>	6.4	<i>0.250</i>	N/A	N/A	9.5	<i>0.375</i>	44.5	<i>1.750</i>
PVF-381127-5-9	5,000	2	38.1	<i>1.500</i>	12.7	<i>0.500</i>	44.2	<i>1.738</i>	15.9	<i>0.625</i>	88.2	<i>3.472</i>
PVF-381191-5-9	5,000	2	38.1	<i>1.500</i>	19.1	<i>0.750</i>	43.2	<i>1.700</i>	22.2	<i>0.875</i>	87.6	<i>3.450</i>
PVF-381381-2.5-9	2,500	2	38.1	<i>1.500</i>	38.1	<i>1.500</i>	44.5	<i>1.750</i>	40.8	<i>1.607</i>	88.9	<i>3.500</i>
PVF-381635-5-9	5,000	2	38.1	<i>1.500</i>	63.5	<i>2.500</i>	40.6	<i>1.600</i>	66.7	<i>2.625</i>	84.7	<i>3.336</i>
PVF-406254-1.5-9	1,500	2	40.6	<i>1.600</i>	25.4	<i>1.000</i>	55.9	<i>2.200</i>	38.1	<i>1.500</i>	102.9	<i>4.050</i>
PVF-445064-10-9	10,000	1	44.5	<i>1.750</i>	6.4	<i>0.250</i>	N/A	N/A	9.5	<i>0.375</i>	50.4	<i>1.986</i>
PVF-445102-5-9	5,000	1	44.5	<i>1.750</i>	10.2	<i>0.400</i>	N/A	N/A	12.7	<i>0.500</i>	50.4	<i>1.986</i>
PVF-445445-2-9	2,000	1	44.5	<i>1.750</i>	44.5	<i>1.750</i>	N/A	N/A	47.6	<i>1.875</i>	50.4	<i>1.986</i>
PVF-478175-5-9	5,000	1	47.8	<i>1.880</i>	17.5	<i>0.690</i>	N/A	N/A	24.4	<i>0.962</i>	66.0	<i>2.600</i>
PVF-508064-10-9	10,000	1	50.8	<i>2.000</i>	6.4	<i>0.250</i>	N/A	N/A	9.5	<i>0.375</i>	56.9	<i>2.240</i>
PVF-508095-5-9	5,000	1	50.8	<i>2.000</i>	9.5	<i>0.375</i>	N/A	N/A	12.7	<i>0.500</i>	57.2	<i>2.250</i>
PVF-508127-10-9	10,000	1	50.8	<i>2.000</i>	12.7	<i>0.500</i>	N/A	N/A	15.9	<i>0.625</i>	56.9	<i>2.240</i>
PVF-508254-5-9	5,000	1	50.8	<i>2.000</i>	25.4	<i>1.000</i>	N/A	N/A	28.6	<i>1.125</i>	57.2	<i>2.250</i>
PVF-508318-2.5-9	2,500	1	50.8	<i>2.000</i>	31.8	<i>1.250</i>	N/A	N/A	34.9	<i>1.375</i>	56.9	<i>2.240</i>
PVF-508508-3-9	3,000	1	50.8	<i>2.000</i>	50.8	<i>2.000</i>	N/A	N/A	54.6	<i>2.150</i>	54.0	<i>2.130</i>
PVF-523841-1.5-9	1,500	1	52.3	<i>2.060</i>	84.1	<i>3.310</i>	N/A	N/A	88.9	<i>3.500</i>	58.2	<i>2.290</i>
PVF-610419-2.5-9	2,500	1	61.0	<i>2.400</i>	41.9	<i>1.650</i>	N/A	N/A	45.5	<i>1.792</i>	67.3	<i>2.650</i>
PVF-699191-5-9	5,000	1	69.9	<i>2.750</i>	19.1	<i>0.750</i>	N/A	N/A	23.3	<i>0.917</i>	76.2	<i>3.000</i>
PVF-699254-5-9	5,000	1	69.9	<i>2.750</i>	25.4	<i>1.000</i>	N/A	N/A	28.6	<i>1.125</i>	76.2	<i>3.000</i>
PVF-762381-2.5-9	2,500	1	76.2	<i>3.000</i>	38.1	<i>1.500</i>	N/A	N/A	41.3	<i>1.625</i>	82.3	<i>3.240</i>
PVF-762508-2.5-9	2,500	1	76.2	<i>3.000</i>	50.8	<i>2.000</i>	N/A	N/A	54.0	<i>2.125</i>	82.6	<i>3.240</i>
PVF-762127-1-9	1,000	1	76.2	<i>3.000</i>	127.0	<i>5.000</i>	N/A	N/A	129.5	<i>5.100</i>	79.4	<i>3.130</i>
PVF-101508-2.5-9	2,500	1	101.6	<i>4.000</i>	50.8	<i>2.000</i>	N/A	N/A	54.6	<i>2.150</i>	104.1	<i>4.100</i>
PVF-101635-2.5-9	2,500	1	101.6	<i>4.000</i>	63.5	<i>2.500</i>	N/A	N/A	66.7	<i>2.625</i>	107.7	<i>4.240</i>
PVF-101762-1.8-9	1,800	1	101.6	<i>4.000</i>	76.2	<i>3.000</i>	N/A	N/A	79.4	<i>3.125</i>	104.1	<i>4.100</i>
PVF-101101-1.3-9	1,300	1	101.6	<i>4.000</i>	101.6	<i>4.000</i>	N/A	N/A	104.8	<i>4.125</i>	104.1	<i>4.100</i>
PVF-101165-0.85-9	850	1	101.6	<i>4.000</i>	165.1	<i>6.500</i>	N/A	N/A	168.3	<i>6.680</i>	104.9	<i>4.130</i>

\*Replace -9 suffix with -4 for yellow labels

**EP Economy paper labels**

Tyco EP is a thermal transfer printable paper with a permanent adhesive, designed for use in general purpose labeling applications requiring a low cost label material. EP has an aggressive adhesive for bonding to corrugated, films and plastic materials, and it is ideal for labeling in mild environments. The ultra-smooth finish is excellent for bar coding applications. EP remains bonded permanently to most surfaces and typically results in label or substrate tear when removal is attempted. For guaranteed print performance use with Tyco's RS series ribbon.

**Features and benefits**

- Thermal transfer printable.
- Ultra-smooth coated facstock.
- Versatile adhesive with excellent initial tack.
- Several die-cut sizes available.



<b>Adhesive</b>	Permanent rubber-based	
<b>Service temperature</b>	-54°C to +66°C	-65°F to +150°F
<b>Recommended printer</b>	T308S*	
<b>Recommended ribbon</b>	1330-0600-10*	

\*Alternative printers and ribbons are available for special applications. Contact Tyco Electronics Identification for more information.



**Part numbering system**



**Ordering information**



**Product dimensions**

Product order code	Package quantity	Labels across	Label width (A)		Label height (B)		Horizontal repeat (C)		Vertical repeat (D)		Web width (E)	
			mm	<i>inches</i>	mm	<i>inches</i>	mm	<i>inches</i>	mm	<i>inches</i>	mm	<i>inches</i>
EP-040040-25-9	25,000	20	4.0	<i>0.157</i>	4.0	<i>0.157</i>	4.0	<i>0.157</i>	7.2	<i>0.281</i>	86.0	<i>3.380</i>
EP-044033-10-9	10,000	20	4.4	<i>0.170</i>	3.3	<i>0.130</i>	4.4	<i>0.170</i>	9.5	<i>0.375</i>	92.4	<i>3.636</i>
EP-064064-25-9	25,000	12	6.4	<i>0.250</i>	6.4	<i>0.250</i>	6.4	<i>0.250</i>	9.5	<i>0.375</i>	82.2	<i>3.240</i>
EP-080080-10-9	10,000	8	8.0	<i>0.315</i>	8.0	<i>0.315</i>	9.9	<i>0.390</i>	13.3	<i>0.525</i>	83.3	<i>3.280</i>
EP-089047-10-9	10,000	5	8.9	<i>0.350</i>	4.7	<i>0.185</i>	11.4	<i>0.450</i>	7.9	<i>0.313</i>	60.6	<i>2.386</i>
EP-095080-25-9	25,000	5	9.5	<i>0.375</i>	8.0	<i>0.315</i>	12.2	<i>0.480</i>	12.7	<i>0.500</i>	64.3	<i>2.531</i>
EP-095095-10-9	10,000	7	9.5	<i>0.375</i>	9.5	<i>0.375</i>	11.1	<i>0.437</i>	12.7	<i>0.500</i>	82.1	<i>3.230</i>
EP-114040-25-9	25,000	6	11.4	<i>0.450</i>	4.0	<i>0.157</i>	11.4	<i>0.450</i>	7.2	<i>0.281</i>	74.6	<i>2.940</i>
EP-127032-10-9	10,000	5	12.7	<i>0.500</i>	3.2	<i>0.125</i>	19.1	<i>0.750</i>	3.2	<i>0.250</i>	94.9	<i>3.736</i>

(continued)

**Product dimensions (continued)**

Product order code	Package quantity	Labels across	Label width (A)		Label height (B)		Horizontal repeat (C)		Vertical repeat (D)		Web width (E)	
			mm	<i>inches</i>	mm	<i>inches</i>	mm	<i>inches</i>	mm	<i>inches</i>	mm	<i>inches</i>
EP-127111-10-9	10,000	5	12.7	<i>0.500</i>	11.1	<i>0.437</i>	16.8	<i>0.662</i>	14.3	<i>0.563</i>	86.0	<i>3.380</i>
EP-127127-10-9	10,000	5	12.7	<i>0.500</i>	12.7	<i>0.500</i>	15.9	<i>0.625</i>	15.9	<i>0.625</i>	82.6	<i>3.250</i>
EP-165051-25-9	25,000	4	16.5	<i>0.650</i>	5.1	<i>0.200</i>	17.8	<i>0.700</i>	8.3	<i>0.325</i>	75.8	<i>2.990</i>
EP-165102-10-9	10,000	5	16.5	<i>0.650</i>	10.2	<i>0.400</i>	19.1	<i>0.750</i>	13.8	<i>0.545</i>	99.1	<i>3.900</i>
EP-171171-10-9	10,000	5	17.1	<i>0.674</i>	17.1	<i>0.674</i>	19.7	<i>0.774</i>	20.3	<i>0.800</i>	101.8	<i>4.006</i>
EP-178095-10-9	10,000	4	17.8	<i>0.700</i>	9.5	<i>0.375</i>	19.1	<i>0.750</i>	12.7	<i>0.500</i>	80.9	<i>3.190</i>
EP-191064-10-9	10,000	4	19.1	<i>0.750</i>	6.4	<i>0.250</i>	21.6	<i>0.850</i>	9.5	<i>0.375</i>	89.9	<i>3.540</i>
EP-191114-15-9	15,000	3	19.1	<i>0.750</i>	11.4	<i>0.450</i>	22.2	<i>0.875</i>	14.7	<i>0.579</i>	69.5	<i>2.736</i>
EP-191762-5-9	5,000	3	19.1	<i>0.750</i>	76.2	<i>3.000</i>	21.6	<i>0.850</i>	88.9	<i>3.500</i>	68.2	<i>2.686</i>
EP-203127-10-9	10,000	4	20.3	<i>0.800</i>	12.7	<i>0.500</i>	22.9	<i>0.900</i>	15.9	<i>0.625</i>	94.6	<i>3.730</i>
EP-208086-5-9	5,000	4	20.8	<i>0.820</i>	8.6	<i>0.340</i>	24.1	<i>0.950</i>	12.7	<i>0.500</i>	101.6	<i>4.000</i>
EP-222159-15-9	15,000	2	22.2	<i>0.875</i>	15.9	<i>0.625</i>	24.8	<i>0.975</i>	19.1	<i>0.750</i>	53.0	<i>2.086</i>
EP-229064-10-9	10,000	3	22.9	<i>0.900</i>	6.4	<i>0.250</i>	28.6	<i>1.125</i>	9.5	<i>0.375</i>	86.0	<i>3.390</i>
EP-250381-10-9	10,000	4	24.9	<i>0.980</i>	38.1	<i>1.500</i>	27.4	<i>1.080</i>	47.6	<i>1.875</i>	113.5	<i>4.470</i>
EP-254045-10-9	10,000	3	25.4	<i>1.000</i>	4.6	<i>0.180</i>	31.8	<i>1.250</i>	8.5	<i>0.333</i>	95.3	<i>3.750</i>
EP-254064-10-9	10,000	3	25.4	<i>1.000</i>	6.4	<i>0.250</i>	27.9	<i>1.100</i>	9.5	<i>0.375</i>	87.3	<i>3.436</i>
EP-254097-10-9	10,000	3	25.4	<i>1.000</i>	9.7	<i>0.380</i>	27.9	<i>1.100</i>	12.7	<i>0.500</i>	87.4	<i>3.440</i>
EP-254127-10-9	10,000	3	25.4	<i>1.000</i>	12.7	<i>0.500</i>	27.9	<i>1.100</i>	16.9	<i>0.666</i>	87.4	<i>3.440</i>
EP-254254-10-9	10,000	3	25.4	<i>1.000</i>	25.4	<i>1.000</i>	27.9	<i>1.100</i>	28.6	<i>1.125</i>	87.4	<i>3.440</i>
EP-305047-10-9	10,000	2	30.5	<i>1.200</i>	4.7	<i>0.185</i>	33.0	<i>1.300</i>	7.8	<i>0.306</i>	69.5	<i>2.736</i>
EP-318064-10-9	10,000	1	31.8	<i>1.250</i>	6.4	<i>0.250</i>	N/A	N/A	9.5	<i>0.375</i>	37.9	<i>1.490</i>
EP-318097-10-9	10,000	1	31.8	<i>1.250</i>	9.7	<i>0.380</i>	N/A	N/A	12.7	<i>0.500</i>	37.8	<i>1.488</i>
EP-381020-10-9	10,000	1	38.1	<i>1.500</i>	2.0	<i>0.080</i>	N/A	N/A	10.7	<i>0.423</i>	44.1	<i>1.740</i>
EP-381064-10-9	10,000	1	38.1	<i>1.500</i>	6.4	<i>0.250</i>	N/A	N/A	9.5	<i>0.375</i>	44.5	<i>1.750</i>
EP-381127-5-9	5,000	2	38.1	<i>1.500</i>	12.7	<i>0.500</i>	44.2	<i>1.738</i>	15.9	<i>0.625</i>	88.2	<i>3.472</i>
EP-381191-5-9	5,000	2	38.1	<i>1.500</i>	19.1	<i>0.750</i>	43.2	<i>1.700</i>	22.2	<i>0.875</i>	87.6	<i>3.450</i>
EP-381381-2.5-9	2,500	2	38.1	<i>1.500</i>	38.1	<i>1.500</i>	44.5	<i>1.750</i>	40.8	<i>1.607</i>	88.9	<i>3.500</i>
EP-381635-5-9	5,000	2	38.1	<i>1.500</i>	63.5	<i>2.500</i>	40.6	<i>1.600</i>	66.7	<i>2.625</i>	84.7	<i>3.336</i>
EP-406254-1.5-9	1,500	2	40.6	<i>1.600</i>	25.4	<i>1.000</i>	55.9	<i>2.200</i>	38.1	<i>1.500</i>	102.9	<i>4.050</i>
EP-445064-10-9	10,000	1	44.5	<i>1.750</i>	6.4	<i>0.250</i>	N/A	N/A	9.5	<i>0.375</i>	50.4	<i>1.986</i>
EP-445102-5-9	5,000	1	44.5	<i>1.750</i>	10.2	<i>0.400</i>	N/A	N/A	12.7	<i>0.500</i>	50.4	<i>1.986</i>
EP-445445-2-9	2,000	1	44.5	<i>1.750</i>	44.5	<i>1.750</i>	N/A	N/A	47.6	<i>1.875</i>	50.4	<i>1.986</i>
EP-478175-5-9	5,000	1	47.8	<i>1.880</i>	17.5	<i>0.690</i>	N/A	N/A	24.4	<i>0.962</i>	66.0	<i>2.600</i>
EP-508064-10-9	10,000	1	50.8	<i>2.000</i>	6.4	<i>0.250</i>	N/A	N/A	9.5	<i>0.375</i>	56.9	<i>2.240</i>
EP-508095-5-9	5,000	1	50.8	<i>2.000</i>	9.5	<i>0.375</i>	N/A	N/A	12.7	<i>0.500</i>	57.2	<i>2.250</i>
EP-508127-10-9	10,000	1	50.8	<i>2.000</i>	12.7	<i>0.500</i>	N/A	N/A	15.9	<i>0.625</i>	56.9	<i>2.240</i>
EP-508254-5-9	5,000	1	50.8	<i>2.000</i>	25.4	<i>1.000</i>	N/A	N/A	28.6	<i>1.125</i>	57.2	<i>2.250</i>
EP-508318-2.5-9	2,500	1	50.8	<i>2.000</i>	31.8	<i>1.250</i>	N/A	N/A	34.9	<i>1.375</i>	56.9	<i>2.240</i>
EP-508508-3-9	3,000	1	50.8	<i>2.000</i>	50.8	<i>2.000</i>	N/A	N/A	54.6	<i>2.150</i>	54.0	<i>2.130</i>
EP-523841-1.5-9	1,500	1	52.3	<i>2.060</i>	84.1	<i>3.310</i>	N/A	N/A	88.9	<i>3.500</i>	58.2	<i>2.290</i>
EP-610419-2.5-9	2,500	1	61.0	<i>2.400</i>	41.9	<i>1.650</i>	N/A	N/A	45.5	<i>1.792</i>	67.3	<i>2.650</i>
EP-699191-5-9	5,000	1	69.9	<i>2.750</i>	19.1	<i>0.750</i>	N/A	N/A	23.3	<i>0.917</i>	76.2	<i>3.000</i>
EP-699254-5-9	5,000	1	69.9	<i>2.750</i>	25.4	<i>1.000</i>	N/A	N/A	28.6	<i>1.125</i>	76.2	<i>3.000</i>
EP-762381-2.5-9	2,500	1	76.2	<i>3.000</i>	38.1	<i>1.500</i>	N/A	N/A	41.3	<i>1.625</i>	82.3	<i>3.240</i>
EP-762508-2.5-9	2,500	1	76.2	<i>3.000</i>	50.8	<i>2.000</i>	N/A	N/A	54.0	<i>2.125</i>	82.6	<i>3.240</i>
EP-762127-1-9	1,000	1	76.2	<i>3.000</i>	127.0	<i>5.000</i>	N/A	N/A	129.5	<i>5.100</i>	79.4	<i>3.130</i>
EP-101508-2.5-9	2,500	1	101.6	<i>4.000</i>	50.8	<i>2.000</i>	N/A	N/A	54.6	<i>2.150</i>	104.1	<i>4.100</i>
EP-101635-2.5-9	2,500	1	101.6	<i>4.000</i>	63.5	<i>2.500</i>	N/A	N/A	66.7	<i>2.625</i>	107.7	<i>4.240</i>
EP-101762-1.8-9	1,800	1	101.6	<i>4.000</i>	76.2	<i>3.000</i>	N/A	N/A	79.4	<i>3.125</i>	104.1	<i>4.100</i>
EP-101101-1.3-9	1,300	1	101.6	<i>4.000</i>	101.6	<i>4.000</i>	N/A	N/A	104.8	<i>4.125</i>	104.1	<i>4.100</i>
EP-101165-0.85-9	850	1	101.6	<i>4.000</i>	165.1	<i>6.500</i>	N/A	N/A	168.3	<i>6.680</i>	104.9	<i>4.130</i>



Electronics

Dot Matrix

**C Vinyl cloth labels**

Tyco C is a dot matrix printable vinyl coated cloth material with a permanent acrylic adhesive that is designed for application to irregular surfaces where conformability is required. It is ideal for permanent wire marking, or it can be flagged onto wires for temporary marking. C is also ideal for electronic component identification and other general purpose labeling applications. For guaranteed print performance and durability, use with Tyco's RI Quick-Dry series ribbon.



**Features and benefits**

- Flexible, easily conforms to curved surfaces.
- Dot matrix printable.
- Several die-cut sizes available.
- Excellent abrasion resistance.
- Resistant to oil, water and several common fluids.



<b>Adhesive</b>	Permanent acrylic	
<b>Service temperature</b>	-29°C to +80°C	-20°F to +176°F
<b>Recommended printer</b>	LQ870*	
<b>Recommended ribbon</b>	1330-0037-00*	
	<i>*Alternative printers and ribbons are available for special applications. Contact Tyco Electronics Identification for more information.</i>	

**Part numbering system**

C-064064-10-9





**C Vinyl cloth labels**

Ordering information

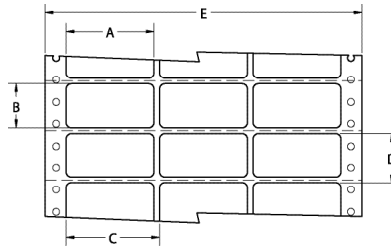

Product dimensions

Product order code	Package quantity	Labels across	Label width (A)		Label height (B)		Horizontal repeat (C)		Vertical repeat (D)		Web width (E)	
			mm	<i>inches</i>	mm	<i>inches</i>	mm	<i>inches</i>	mm	<i>inches</i>	mm	<i>inches</i>
C-064064-10-9	10,000	20	6.4	<i>0.250</i>	6.4	<i>0.250</i>	6.4	<i>0.250</i>	8.5	<i>0.333</i>	152.4	<i>6.000</i>
C-076191-10-9	10,000	16	7.6	<i>0.300</i>	19.1	<i>0.750</i>	7.6	<i>0.300</i>	25.4	<i>1.000</i>	147.3	<i>5.800</i>
C-080080-10-9	10,000	10	8.0	<i>0.315</i>	8.0	<i>0.315</i>	8.0	<i>0.315</i>	12.7	<i>0.500</i>	105.4	<i>4.150</i>
C-095095-10-9	10,000	16	9.5	<i>0.375</i>	9.5	<i>0.375</i>	12.7	<i>0.500</i>	12.7	<i>0.500</i>	226.1	<i>8.900</i>
C-115064-10-9	10,000	8	11.5	<i>0.450</i>	6.4	<i>0.250</i>	14.0	<i>0.550</i>	9.5	<i>0.375</i>	134.6	<i>5.300</i>
C-121064-10-9	10,000	8	12.1	<i>0.475</i>	6.4	<i>0.250</i>	14.6	<i>0.575</i>	8.5	<i>0.333</i>	139.7	<i>5.500</i>
C-154064-10-9	10,000	7	15.4	<i>0.600</i>	6.4	<i>0.250</i>	17.8	<i>0.700</i>	8.5	<i>0.333</i>	147.3	<i>5.800</i>
C-159079-10-9	10,000	8	15.9	<i>0.625</i>	7.9	<i>0.310</i>	19.1	<i>0.750</i>	12.7	<i>0.500</i>	174.6	<i>6.875</i>
C-165051-10-9	10,000	10	16.5	<i>0.650</i>	5.1	<i>0.200</i>	20.3	<i>0.800</i>	6.4	<i>0.250</i>	224.8	<i>8.850</i>
C-191064-10-9	10,000	9	19.1	<i>0.750</i>	6.4	<i>0.250</i>	22.9	<i>0.900</i>	8.5	<i>0.333</i>	227.3	<i>8.950</i>
C-203127-10-9	10,000	10	20.3	<i>0.800</i>	12.7	<i>0.500</i>	20.3	<i>0.800</i>	15.9	<i>0.625</i>	228.6	<i>9.000</i>
C-203365-10-9	10,000	6	20.3	<i>0.800</i>	36.5	<i>1.437</i>	22.9	<i>0.900</i>	38.1	<i>1.500</i>	160.0	<i>6.300</i>
C-215055-10-9	10,000	5	21.5	<i>0.846</i>	5.5	<i>0.217</i>	25.4	<i>1.000</i>	8.5	<i>0.333</i>	148.6	<i>5.850</i>
C-229064-10-9	10,000	8	22.9	<i>0.900</i>	6.4	<i>0.250</i>	25.4	<i>1.000</i>	8.5	<i>0.333</i>	226.1	<i>8.900</i>
C-254095-10-9	10,000	7	25.4	<i>1.000</i>	9.5	<i>0.375</i>	27.9	<i>1.100</i>	12.7	<i>0.500</i>	218.4	<i>8.600</i>
C-254127-10-9	10,000	7	25.4	<i>1.000</i>	12.7	<i>0.500</i>	27.9	<i>1.100</i>	16.9	<i>0.666</i>	218.4	<i>8.600</i>
C-293064-10-9	10,000	4	29.3	<i>1.150</i>	6.4	<i>0.250</i>	9.4	<i>0.370</i>	30.5	<i>1.200</i>	146.1	<i>5.750</i>
C-381064-10-S1-9	10,000	4*	38.1	<i>1.500</i>	6.4	<i>0.250</i>	45.7	<i>1.800</i>	8.5	<i>0.333</i>	200.7	<i>7.900</i>
C-394064-10-9	10,000	4	39.4	<i>1.550</i>	6.4	<i>0.250</i>	41.9	<i>1.650</i>	8.5	<i>0.333</i>	190.5	<i>7.500</i>
C-508095-5-9	5,000	3	50.8	<i>2.000</i>	9.5	<i>0.375</i>	53.3	<i>2.100</i>	12.7	<i>0.500</i>	182.9	<i>7.200</i>
C-533064-5-9	5,000	3	53.3	<i>2.100</i>	6.4	<i>0.250</i>	55.9	<i>2.200</i>	8.5	<i>0.333</i>	190.5	<i>7.500</i>
C-533114-5-9	5,000	3	53.3	<i>2.100</i>	11.4	<i>0.450</i>	55.9	<i>2.200</i>	14.7	<i>0.579</i>	190.5	<i>7.500</i>

\*Perforated



Electronics

Dot Matrix

**M Metalized polyester labels**

Tyco M is a dot matrix printable metalized polyester film with a permanent acrylic adhesive that is designed for rating plate applications and other applications that require a "metal look" such as nameplates, rating plates and equipment labels to detail product information and serial numbers. M is UL Listed and CSA Certified, and its print performance and durability are guaranteed when used with Tyco's RI Quick-Dry series ribbon.



**Features and benefits**

- Dot matrix printable.
- Exceptional durability and strength.
- Matte finish ink receptive coating for better contrast.
- Resistant to oil, water and several common fluids.
- UL Listed and CSA Certified.



<b>Adhesive</b>	Permanent acrylic
<b>Service temperature</b>	-53°C to +93°C    -65°F to +200°F
<b>Recommended printer</b>	LQ870*
<b>Recommended ribbon</b>	1330-0037-00*

*\*Alternative printers and ribbons are available for special applications. Contact Tyco Electronics Identification for more information.*

**Part numbering system**

M-064064-10-8A



**M Metalized polyester labels (Cont'd)**

Ordering information



Product dimensions

Product order code	Package quantity	Labels across	Label width (A)		Label height (B)		Horizontal repeat (C)		Vertical repeat (D)		Web width (E)	
			mm	<i>inches</i>	mm	<i>inches</i>	mm	<i>inches</i>	mm	<i>inches</i>	mm	<i>inches</i>
M-064064-10-8A	10,000	20	6.4	<i>0.250</i>	6.4	<i>0.250</i>	6.4	<i>0.250</i>	8.5	<i>0.333</i>	152.4	<i>6.000</i>
M-076191-10-8A	10,000	16	7.6	<i>0.300</i>	19.1	<i>0.750</i>	7.6	<i>0.300</i>	25.4	<i>1.000</i>	147.3	<i>5.800</i>
M-080080-10-8A	10,000	10	8.0	<i>0.315</i>	8.0	<i>0.315</i>	8.0	<i>0.315</i>	12.7	<i>0.500</i>	105.4	<i>4.150</i>
M-095095-10-8A	10,000	16	9.5	<i>0.375</i>	9.5	<i>0.375</i>	12.7	<i>0.500</i>	12.7	<i>0.500</i>	226.1	<i>8.900</i>
M-102070-10-8A	10,000	4	10.2	<i>0.400</i>	7.0	<i>0.275</i>	15.9	<i>0.625</i>	9.5	<i>0.375</i>	83.2	<i>3.275</i>
M-115064-10-8A	10,000	8	11.5	<i>0.450</i>	6.4	<i>0.250</i>	14.0	<i>0.550</i>	9.5	<i>0.375</i>	134.6	<i>5.300</i>
M-121064-10-8A	10,000	8	12.1	<i>0.475</i>	6.4	<i>0.250</i>	14.6	<i>0.575</i>	8.5	<i>0.333</i>	139.7	<i>5.500</i>
M-127111-10-8A	10,000	13	12.7	<i>0.500</i>	11.1	<i>0.437</i>	15.2	<i>0.600</i>	15.9	<i>0.625</i>	221.0	<i>8.700</i>
M-127191-10-8A	10,000	12	12.7	<i>0.500</i>	19.1	<i>0.750</i>	15.2	<i>0.600</i>	25.4	<i>1.000</i>	205.7	<i>8.100</i>
M-154064-10-8A	10,000	7	15.4	<i>0.600</i>	6.4	<i>0.250</i>	17.8	<i>0.700</i>	8.5	<i>0.333</i>	147.3	<i>5.800</i>
M-159079-10-8A	10,000	8	15.9	<i>0.625</i>	7.9	<i>0.310</i>	19.1	<i>0.750</i>	12.7	<i>0.500</i>	174.6	<i>6.875</i>
M-165051-10-8A	10,000	10	16.5	<i>0.650</i>	5.1	<i>0.200</i>	20.3	<i>0.800</i>	6.4	<i>0.250</i>	224.8	<i>8.850</i>
M-191064-10-8A	10,000	9	19.1	<i>0.750</i>	6.4	<i>0.250</i>	22.9	<i>0.900</i>	8.5	<i>0.333</i>	227.3	<i>8.950</i>
M-203064-10-8A	10,000	10	20.3	<i>0.800</i>	6.4	<i>0.250</i>	20.3	<i>0.800</i>	8.5	<i>0.333</i>	228.6	<i>9.000</i>
M-203127-10-8A	10,000	10	20.3	<i>0.800</i>	12.7	<i>0.500</i>	20.3	<i>0.800</i>	15.9	<i>0.625</i>	228.6	<i>9.000</i>
M-203365-10-8A	10,000	6	20.3	<i>0.800</i>	36.5	<i>1.437</i>	22.9	<i>0.900</i>	38.1	<i>1.500</i>	160.0	<i>6.300</i>
M-215055-10-8A	10,000	5	21.5	<i>0.846</i>	5.5	<i>0.217</i>	25.4	<i>1.000</i>	8.5	<i>0.333</i>	148.6	<i>5.850</i>
M-229064-10-8A	10,000	8	22.9	<i>0.900</i>	6.4	<i>0.250</i>	25.4	<i>1.000</i>	8.5	<i>0.333</i>	226.1	<i>8.900</i>
M-254095-10-8A	10,000	7	25.4	<i>1.000</i>	9.5	<i>0.375</i>	27.9	<i>1.100</i>	12.7	<i>0.500</i>	218.4	<i>8.600</i>
M-254127-10-8A	10,000	7	25.4	<i>1.000</i>	12.7	<i>0.500</i>	27.9	<i>1.100</i>	16.9	<i>0.666</i>	218.4	<i>8.600</i>
M-293064-10-8A	10,000	4	29.3	<i>1.150</i>	6.4	<i>0.250</i>	9.4	<i>0.370</i>	30.5	<i>1.200</i>	146.1	<i>5.750</i>
M-381191-10-8A	10,000	4	38.1	<i>1.500</i>	19.1	<i>0.750</i>	43.2	<i>1.700</i>	25.4	<i>1.000</i>	193.0	<i>7.600</i>
M-394064-10-8A	10,000	4	39.4	<i>1.550</i>	6.4	<i>0.250</i>	41.9	<i>1.650</i>	8.5	<i>0.333</i>	190.5	<i>7.500</i>
M-508095-5-8A	5,000	3	50.8	<i>2.000</i>	9.5	<i>0.375</i>	53.3	<i>2.100</i>	12.7	<i>0.500</i>	182.9	<i>7.200</i>
M-508254-4-8A	4,000	4	50.8	<i>2.000</i>	25.4	<i>1.075</i>	50.8	<i>2.000</i>	28.6	<i>1.125</i>	228.6	<i>9.000</i>
M-508318-3-8A	3,000	4	50.8	<i>2.000</i>	31.8	<i>1.250</i>	50.8	<i>2.000</i>	34.9	<i>1.375</i>	228.6	<i>9.000</i>
M-533064-5-8A	5,000	3	53.3	<i>2.100</i>	6.4	<i>0.250</i>	55.9	<i>2.200</i>	8.5	<i>0.333</i>	190.5	<i>7.500</i>
M-533114-5-8A	5,000	3	53.3	<i>2.100</i>	11.4	<i>0.450</i>	55.9	<i>2.200</i>	14.7	<i>0.579</i>	190.5	<i>7.500</i>
M-572286-2.5-8A	2,500	1	57.2	<i>2.250</i>	28.6	<i>1.130</i>	N/A	N/A	31.8	<i>1.250</i>	82.6	<i>3.250</i>
M-673254-3-8A	3,000	3	67.3	<i>2.650</i>	25.4	<i>1.000</i>	67.3	<i>2.650</i>	38.1	<i>1.500</i>	227.3	<i>8.950</i>
M-673349-3-8A	3,000	3	67.3	<i>2.650</i>	34.9	<i>1.375</i>	67.3	<i>2.650</i>	38.1	<i>1.500</i>	227.3	<i>8.950</i>
M-699254-2.5-8A	2,500	3	69.9	<i>2.750</i>	25.4	<i>1.000</i>	73.0	<i>2.875</i>	28.6	<i>1.125</i>	241.3	<i>9.500</i>
M-699318-2.5-8A	2,500	3	69.9	<i>2.750</i>	31.8	<i>1.250</i>	73.0	<i>2.875</i>	34.9	<i>1.375</i>	241.3	<i>9.500</i>
M-711064-5-8A	5,000	1	71.1	<i>2.800</i>	6.4	<i>0.250</i>	N/A	N/A	8.5	<i>0.333</i>	96.5	<i>3.800</i>
M-762508-1-8A	1,000	2	76.2	<i>3.000</i>	50.8	<i>2.000</i>	79.4	<i>3.125</i>	54.0	<i>2.125</i>	181.0	<i>7.130</i>
M-920254-2.5-8A	2,500	2	92.0	<i>3.620</i>	25.4	<i>1.000</i>	94.6	<i>3.725</i>	28.6	<i>1.125</i>	212.1	<i>8.350</i>
M-920381-2.5-8A	2,500	2	92.0	<i>3.620</i>	38.1	<i>1.500</i>	95.3	<i>3.750</i>	41.3	<i>1.625</i>	212.8	<i>8.380</i>
M-165101-1-8A	1,000	1	165.1	<i>6.500</i>	101.6	<i>4.000</i>	N/A	N/A	108.0	<i>4.250</i>	190.5	<i>7.500</i>



Electronics

Dot Matrix

**K Kapton® labels**

Tyco K is a dot matrix printable, 2 mil thick tan polyimide (Kapton®) with a permanent acrylic adhesive that is ideal for high temperature labeling requirements such as printed circuit boards. It is suitable for direct wave (bottom side) and IR reflow (top side) PCB applications, and is designed to withstand the fluxes, cleaning solvents and molten solder encountered in the manufacture of printed circuit boards. With a flash exposure service temperature of +538°C (+1000°F), K is suitable for the harshest high temperature applications. For guaranteed print performance and durability, use with Tyco's RI Quick-Dry series ribbon.



**Features and benefits**

- Dot matrix printable.
- Matte finish for better print contrast.
- Product approved for aerospace/defense applications.
- Exceptional durability and tear resistance.
- High temperature permanent acrylic adhesive.
- Superior solvent and UV resistance.
- Low outgassing.



<b>Adhesive</b>	Permanent acrylic
<b>Service temperature*</b>	-40°C to +260°C    -40°F to +500°F *Flash exposure to +538°C (+1000°F)
<b>Recommended printer</b>	LQ870**
<b>Recommended ribbon</b>	1330-0037-00**

\*\*Alternative printers and ribbons are available for special applications. Contact Tyco Electronics Identification for more information.

**Part numbering system**

K-064064-10-1A



Ordering information



Product dimensions

Product order code	Package quantity	Labels across	Label width (A)		Label height (B)		Horizontal repeat (C)		Vertical repeat (D)		Web width (E)	
			mm	<i>inches</i>	mm	<i>inches</i>	mm	<i>inches</i>	mm	<i>inches</i>	mm	<i>inches</i>
K-064064-10-1A	10,000	20	6.4	<i>0.250</i>	6.4	<i>0.250</i>	6.4	<i>0.250</i>	8.5	<i>0.333</i>	152.4	<i>6.000</i>
K-076191-10-1A	10,000	16	7.6	<i>0.300</i>	19.1	<i>0.750</i>	7.6	<i>0.300</i>	25.4	<i>1.000</i>	147.3	<i>5.800</i>
K-080080-10-1A	10,000	10	8.0	<i>0.315</i>	8.0	<i>0.315</i>	8.0	<i>0.315</i>	12.7	<i>0.500</i>	105.4	<i>4.150</i>
K-095095-10-1A	10,000	16	9.5	<i>0.375</i>	9.5	<i>0.375</i>	12.7	<i>0.500</i>	12.7	<i>0.500</i>	226.1	<i>8.900</i>
K-115064-10-1A	10,000	8	11.5	<i>0.450</i>	6.4	<i>0.250</i>	14.0	<i>0.550</i>	9.5	<i>0.375</i>	134.6	<i>5.300</i>
K-121064-10-1A	10,000	8	12.1	<i>0.475</i>	6.4	<i>0.250</i>	14.6	<i>0.575</i>	8.5	<i>0.333</i>	139.7	<i>5.500</i>
K-154064-10-1A	10,000	7	15.4	<i>0.600</i>	6.4	<i>0.250</i>	17.8	<i>0.700</i>	8.5	<i>0.333</i>	147.3	<i>5.800</i>
K-159079-10-1A	10,000	8	15.9	<i>0.625</i>	7.9	<i>0.310</i>	19.1	<i>0.750</i>	12.7	<i>0.500</i>	174.6	<i>6.875</i>
K-165051-10-1A	10,000	10	16.5	<i>0.650</i>	5.1	<i>0.200</i>	20.3	<i>0.800</i>	6.4	<i>0.250</i>	224.8	<i>8.850</i>
K-191064-10-1A	10,000	9	19.1	<i>0.750</i>	6.4	<i>0.250</i>	22.9	<i>0.900</i>	8.5	<i>0.333</i>	227.3	<i>8.950</i>
K-203127-10-1A	10,000	10	20.3	<i>0.800</i>	12.7	<i>0.500</i>	20.3	<i>0.800</i>	15.9	<i>0.625</i>	228.6	<i>9.000</i>
K-203365-10-1A	10,000	6	20.3	<i>0.800</i>	36.5	<i>1.437</i>	22.9	<i>0.900</i>	38.1	<i>1.500</i>	160.0	<i>6.300</i>
K-215055-10-1A	10,000	5	21.5	<i>0.846</i>	5.5	<i>0.217</i>	25.4	<i>1.000</i>	8.5	<i>0.333</i>	148.6	<i>5.850</i>
K-229064-10-1A	10,000	8	22.9	<i>0.900</i>	6.4	<i>0.250</i>	25.4	<i>1.000</i>	8.5	<i>0.333</i>	226.1	<i>8.900</i>
K-254095-10-1A	10,000	7	25.4	<i>1.000</i>	9.5	<i>0.375</i>	27.9	<i>1.100</i>	12.7	<i>0.500</i>	218.4	<i>8.600</i>
K-254127-10-1A	10,000	7	25.4	<i>1.000</i>	12.7	<i>0.500</i>	27.9	<i>1.100</i>	16.9	<i>0.666</i>	218.4	<i>8.600</i>
K-293064-10-1A	10,000	4	29.3	<i>1.150</i>	6.4	<i>0.250</i>	9.4	<i>0.370</i>	30.5	<i>1.200</i>	146.1	<i>5.750</i>
K-508095-5-1A	5,000	3	50.8	<i>2.000</i>	9.5	<i>0.375</i>	53.3	<i>2.100</i>	12.7	<i>0.500</i>	182.9	<i>7.200</i>
K-533064-5-1A	5,000	3	53.3	<i>2.100</i>	6.4	<i>0.250</i>	55.9	<i>2.200</i>	8.5	<i>0.333</i>	190.5	<i>7.500</i>



Electronics

Dot Matrix

**E White polyester labels**

Tyco E is a dot matrix printable white polyester film with a permanent acrylic adhesive that is ideal for PCB and component labeling, as well as general purpose labeling applications that require a high durability white label. It is resistant to a variety of solvents while maintaining print quality. E is UL Listed and CSA Certified, and its print performance and durability are guaranteed when used with Tyco's RI Quick-Dry series ribbon.



**Features and benefits**

- Dot matrix printable.
- Cost-efficient for general purpose, low volume applications.
- Exceptional durability and strength.
- Resistant to oil, water and several common fluids.
- UL Listed and CSA Certified.



<b>Adhesive</b>	Permanent acrylic
<b>Service temperature</b>	-53°C to +93°C    -65°F to +200°F
<b>Recommended printer</b>	LQ870*
<b>Recommended ribbon</b>	1330-0037-00*

\*Alternative printers and ribbons are available for special applications. Contact Tyco Electronics Identification for more information.

**Part numbering system**

E-064064-10-9



- Color
- Pack size
- Label height (mm)
- Label width (mm)
- Product family

**E White polyester labels (Cont'd)**

Ordering information



Product dimensions

Product order code	Package quantity	Labels across	Label width (A) mm <i>inches</i>	Label height (B) mm <i>inches</i>	Horizontal repeat (C) mm <i>inches</i>	Vertical repeat (D) mm <i>inches</i>	Web width (E) mm <i>inches</i>
E-064064-10-9	10,000	20	6.4 <i>0.250</i>	6.4 <i>0.250</i>	6.4 <i>0.250</i>	8.5 <i>0.333</i>	152.4 <i>6.000</i>
E-076191-10-9	10,000	16	7.6 <i>0.300</i>	19.1 <i>0.750</i>	7.6 <i>0.300</i>	25.4 <i>1.000</i>	147.3 <i>5.800</i>
E-080080-10-9	10,000	10	8.0 <i>0.315</i>	8.0 <i>0.315</i>	8.0 <i>0.315</i>	12.7 <i>0.500</i>	105.4 <i>4.150</i>
E-095095-10-9	10,000	16	9.5 <i>0.375</i>	9.5 <i>0.375</i>	12.7 <i>0.500</i>	12.7 <i>0.500</i>	226.1 <i>8.900</i>
E-102070-10-9	10,000	4	10.2 <i>0.400</i>	7.0 <i>0.275</i>	15.9 <i>0.625</i>	9.5 <i>0.375</i>	83.2 <i>3.275</i>
E-115064-10-9	10,000	8	11.5 <i>0.450</i>	6.4 <i>0.250</i>	14.0 <i>0.550</i>	9.5 <i>0.375</i>	134.6 <i>5.300</i>
E-121064-10-9	10,000	8	12.1 <i>0.475</i>	6.4 <i>0.250</i>	14.6 <i>0.575</i>	8.5 <i>0.333</i>	139.7 <i>5.500</i>
E-127111-10-9	10,000	13	12.7 <i>0.500</i>	11.1 <i>0.437</i>	15.2 <i>0.600</i>	15.9 <i>0.625</i>	221 <i>8.700</i>
E-127191-10-9	10,000	12	12.7 <i>0.500</i>	19.1 <i>0.750</i>	15.2 <i>0.600</i>	25.4 <i>1.000</i>	205.7 <i>8.100</i>
E-154064-10-9	10,000	7	15.4 <i>0.600</i>	6.4 <i>0.250</i>	17.8 <i>0.700</i>	8.5 <i>0.333</i>	147.3 <i>5.800</i>
E-159079-10-9	10,000	8	15.9 <i>0.625</i>	7.9 <i>0.310</i>	19.1 <i>0.750</i>	12.7 <i>0.500</i>	174.6 <i>6.875</i>
E-165051-10-9	10,000	10	16.5 <i>0.650</i>	5.1 <i>0.200</i>	20.3 <i>0.800</i>	6.4 <i>0.250</i>	224.8 <i>8.850</i>
E-191064-10-9	10,000	9	19.1 <i>0.750</i>	6.4 <i>0.250</i>	22.9 <i>0.900</i>	8.5 <i>0.333</i>	227.3 <i>8.950</i>
E-203064-10-9	10,000	10	20.3 <i>0.800</i>	6.4 <i>0.250</i>	20.3 <i>0.800</i>	8.5 <i>0.333</i>	228.6 <i>9.000</i>
E-203127-10-9	10,000	10	20.3 <i>0.800</i>	12.7 <i>0.500</i>	20.3 <i>0.800</i>	15.9 <i>0.625</i>	228.6 <i>9.000</i>
E-203365-10-9	10,000	6	20.3 <i>0.800</i>	36.5 <i>1.437</i>	22.9 <i>0.900</i>	38.1 <i>1.500</i>	160.0 <i>6.300</i>
E-215055-10-9	10,000	5	21.5 <i>0.846</i>	5.5 <i>0.217</i>	25.4 <i>1.000</i>	8.5 <i>0.333</i>	148.6 <i>5.850</i>
E-229064-10-9	10,000	8	22.9 <i>0.900</i>	6.4 <i>0.250</i>	25.4 <i>1.000</i>	8.5 <i>0.333</i>	226.1 <i>8.900</i>
E-254095-10-9	10,000	7	25.4 <i>1.000</i>	9.5 <i>0.375</i>	27.9 <i>1.100</i>	12.7 <i>0.500</i>	218.4 <i>8.600</i>
E-254127-10-9	10,000	7	25.4 <i>1.000</i>	12.7 <i>0.500</i>	27.9 <i>1.100</i>	16.9 <i>0.666</i>	218.4 <i>8.600</i>
E-293064-10-9	10,000	4	29.3 <i>1.150</i>	6.4 <i>0.250</i>	9.4 <i>0.370</i>	30.5 <i>1.200</i>	146.1 <i>5.750</i>
E-381191-10-9	10,000	4	38.1 <i>1.500</i>	19.1 <i>0.750</i>	43.2 <i>1.700</i>	25.4 <i>1.000</i>	193.0 <i>7.600</i>
E-394064-10-9	10,000	4	39.4 <i>1.550</i>	6.4 <i>0.250</i>	41.9 <i>1.650</i>	8.5 <i>0.333</i>	190.5 <i>7.500</i>
E-508095-5-9	5,000	3	50.8 <i>2.000</i>	9.5 <i>0.375</i>	53.3 <i>2.100</i>	12.7 <i>0.500</i>	182.9 <i>7.200</i>
E-508254-4-9	4,000	4	50.8 <i>2.000</i>	25.4 <i>1.000</i>	50.8 <i>2.000</i>	28.6 <i>1.125</i>	228.6 <i>9.000</i>
E-508318-3-9	3,000	4	50.8 <i>2.000</i>	31.8 <i>1.250</i>	50.8 <i>2.000</i>	34.9 <i>1.375</i>	228.6 <i>9.000</i>
E-533064-5-9	5,000	3	53.3 <i>2.100</i>	6.4 <i>0.250</i>	55.9 <i>2.200</i>	8.5 <i>0.333</i>	190.5 <i>7.500</i>
E-533114-5-9	5,000	3	53.3 <i>2.100</i>	11.4 <i>0.450</i>	55.9 <i>2.200</i>	14.7 <i>0.579</i>	190.5 <i>7.500</i>
E-572286-2-5-9	2,500	1	57.2 <i>2.250</i>	28.6 <i>1.125</i>	N/A N/A	31.8 <i>1.250</i>	82.6 <i>3.250</i>
E-673254-3-9	3,000	3	67.3 <i>2.650</i>	25.4 <i>1.000</i>	67.3 <i>2.650</i>	38.1 <i>1.500</i>	227.3 <i>8.950</i>
E-673349-3-9	3,000	3	67.3 <i>2.650</i>	34.9 <i>1.375</i>	67.3 <i>2.650</i>	38.1 <i>1.500</i>	227.3 <i>8.950</i>
E-699254-2-5-9	2,500	3	69.9 <i>2.750</i>	25.4 <i>1.000</i>	73.0 <i>2.875</i>	28.6 <i>1.125</i>	241.3 <i>9.500</i>
E-699318-2-5-9	2,500	3	69.9 <i>2.750</i>	31.8 <i>1.250</i>	73.0 <i>2.875</i>	34.9 <i>1.375</i>	241.3 <i>9.500</i>
E-711064-5-9	5,000	1	71.1 <i>2.800</i>	6.4 <i>0.250</i>	N/A N/A	8.5 <i>0.333</i>	96.5 <i>3.800</i>
E-762508-1-9	1,000	2	76.2 <i>3.000</i>	50.8 <i>2.000</i>	79.4 <i>3.125</i>	54.0 <i>2.125</i>	181.0 <i>7.130</i>
E-920254-2-5-9	2,500	2	92.0 <i>3.620</i>	25.4 <i>1.000</i>	94.6 <i>3.725</i>	28.6 <i>1.125</i>	212.1 <i>8.350</i>
E-920381-2-5-9	2,500	2	92.0 <i>3.620</i>	38.1 <i>1.500</i>	95.3 <i>3.750</i>	41.3 <i>1.625</i>	212.8 <i>8.380</i>
E-165101-1-9	1,000	1	165.1 <i>6.500</i>	101.6 <i>4.000</i>	N/A N/A	108.0 <i>4.250</i>	190.5 <i>7.500</i>

**LE/LM/LEB2 Polyester Labels**

**LE**

Tyco LE is a white polyester film with a permanent acrylic adhesive and a special top-coat designed specifically for use with laser and ink jet printers. It is ideal for bar coding, PCB and component labeling, and general labeling applications requiring a white high durability label. LE offers high print resolution as well as good solvent and smudge resistance.

**LM**

Tyco LM is a metalized polyester film with a permanent acrylic adhesive and a special top-coat designed specifically for use with laser and ink jet printers. It is ideal for rating plate applications and other applications that require a "metal look" such as nameplates and equipment labels to detail product information and serial numbers.

Note: On large label formats, some curl may occur on printing due to duration of time in the laser printer.

**LEB2**

LEB2, our A4 size symmetrically-designed laser and ink jet labels, guarantee a proper feeding in the paper tray. The label sheet can be used in both directions and is also usable for the stack function of your printer. The sheets can be used several times if partial label amounts need to be printed. Special surface coatings guarantee an extremely high aging-resistance of the printing image.

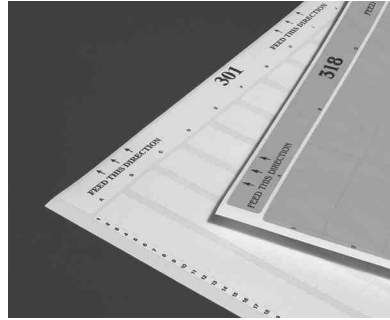

**Features and benefits**

- Laser printable.
- Exceptional durability and tear strength.
- Suitable for low volume applications.
- Excellent for bar code applications.
- Good resistance to common fluids and water.
- LM metalized appearance is ideal for rating plate applications.
- LEB2 features symmetrical design – can be printed on from both top sides.



<b>Adhesive</b>	Permanent acrylic
<b>Service temperature</b>	-40°C to +150°C    -40°F to +302°F

**Ordering information**





**Ordering information (continued)**

**LE**

Product order code	Package quantity	Labels across	Labels per sheet	Label width (A)		Label height (B)		Horizontal repeat (C)		Vertical repeat (D)	
				mm	inches	mm	inches	mm	inches	mm	inches
314-LE	4,000	16	400	9.5	0.375	9.5	0.375	12.7	0.500	9.5	0.375
301-LE	4,800	10	480	16.5	0.650	5.1	0.200	20.3	0.800	5.1	0.200
303-LE	3,040	8	304	20.3	0.800	6.4	0.250	25.4	1.000	6.4	0.250
304-LE	1,520	8	152	20.3	0.800	12.7	0.500	25.4	1.000	12.7	0.500
309-LE	2,660	7	266	25.4	1.000	6.4	0.250	27.9	1.100	6.4	0.250
305-LE	1,750	7	175	25.4	1.000	9.5	0.375	27.9	1.100	9.5	0.375
307-LE	1,330	7	133	25.4	1.000	12.7	0.500	27.9	1.100	12.7	0.500
310-LE	1,900	5	190	38.1	1.500	6.4	0.250	40.6	1.600	6.4	0.250
308-LE	600	5	60	38.1	1.500	19.1	0.750	40.6	1.600	19.1	0.750
318-LE	400	4	40	50.8	2.000	25.4	1.000	50.8	2.000	25.4	1.000
319-LE	100	2	10	76.2	3.000	50.8	2.000	88.9	3.500	50.8	2.000
325-LE	10	1	1	215.9	8.500	279.4	11.000	N/A	N/A	N/A	N/A

**LM**

Product order code	Package quantity	Labels across	Labels per sheet	Label width (A)		Label height (B)		Horizontal repeat (C)		Vertical repeat (D)	
				mm	inches	mm	inches	mm	inches	mm	inches
314-LM	4,000	16	400	9.5	0.375	9.5	0.375	12.7	0.500	9.5	0.375
301-LM	4,800	10	480	16.5	0.650	5.1	0.200	20.3	0.800	5.1	0.200
303-LM	3,040	8	304	20.3	0.800	6.4	0.250	25.4	1.000	6.4	0.250
304-LM	1,520	8	152	20.3	0.800	12.7	0.500	25.4	1.000	12.7	0.500
309-LM	2,660	7	266	25.4	1.000	6.4	0.250	27.9	1.100	6.4	0.250
305-LM	1,750	7	175	25.4	1.000	9.5	0.375	27.9	1.100	9.5	0.375
307-LM	1,330	7	133	25.4	1.000	12.7	0.500	27.9	1.100	12.7	0.500
310-LM	1,900	5	190	38.1	1.500	6.4	0.250	40.6	1.600	6.4	0.250
308-LM	600	5	60	38.1	1.500	19.1	0.750	40.6	1.600	19.1	0.750
318-LM	400	4	40	50.8	2.000	25.4	1.000	50.8	2.000	25.4	1.000
319-LM	100	2	10	76.2	3.000	50.8	2.000	88.9	3.500	50.8	2.000
325-LM	10	1	1	215.9	8.500	279.4	11.000	N/A	N/A	N/A	N/A

**LEB2**

Product order code	Labels per sheet	Label height		Label width		Labels per column	Labels per row
		mm	inches	mm	inches		
LEB2-0615P <color>	480	6.0	0.236	15.0	0.590	48	10
LEB2-0818P <color>	324	8.0	0.315	18.0	0.709	36	9
LEB2-0820P <color>	288	8.0	0.315	20.0	0.787	36	8
LEB2-0825P <color>	252	8.0	0.315	25.0	0.984	36	7
LEB2-0916P <color>	320	9.0	0.354	16.0	0.630	32	10
LEB2-0920P <color>	256	9.0	0.354	20.0	0.787	32	8
LEB2-1318P <color>	198	13.0	0.512	18.0	0.709	22	9
LEB2-1325P <color>	154	13.0	0.512	25.0	0.984	22	7

**Sheet sizes**

LE, LM	8.5" x 11"
LEB2	A4

**Options (LEB2 only)**

Colors	Yellow	White	Silver
Code	G	W	S

### PRINTERS

T200 Series Printers .....	107
T300 Series Printers .....	108
T400 Series Printers .....	109
T6 12M-DS Printer .....	110
AM6310 Printer .....	111
LQ870 Printer .....	112
LMS-9000 Laser Marking System .....	113

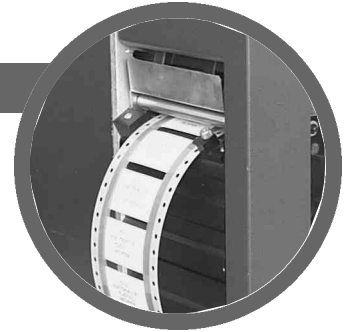

### RIBBONS

Thermal Transfer .....	114
Dot Matrix .....	120



### SOFTWARE

WinTotal .....	122
PrintEasy .....	124

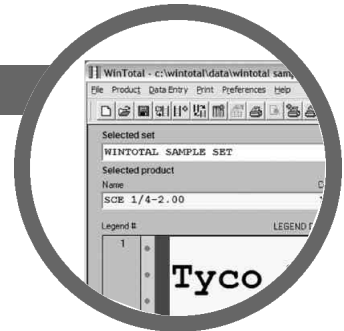

### APPLICATION SYSTEMS

Hot Air Gun .....	126
-------------------	-----



**T200 Series Portable thermal transfer printers**

The T200 Series of printers are portable/desktop thermal transfer printers with a 4.1" print head offering an economical option for low volume customers who want to take advantage of thermal transfer printing technology. Their small, light weight design makes them ideal for applications requiring portability or in environments with multiple workstations where space is limited.

The T208M has a 200 dpi print head; the T2 12M has a 300 dpi print head for crisp, high quality text, bar codes and graphic images. Both printers are designed for use with Tyco's range of TMS heat shrinkable wire marker sleeves and limited thermal transfer printable pressure sensitive label products.



**Printer specifications**

Print head width	104 mm (4.09")
Print head resolution	T208M: 8 dpmm (203 dpi) T2 12M: 12 dpmm (305 dpi)
Print speed (maximum)	51 mm per second (2 inches per second)
Media sensor	Transmissive – fixed
Memory	T208M: 256 KB SRAM and 512 KB flash T2 12M: 512 KB SRAM and 1 MB flash
Communication interface	Parallel (centronics) and serial (RS232)
Printer dimensions	200 mm W x 247 mm D x 171 mm H (7.9" W x 9.75" D x 6.75" H)
Printer weight	1.81 kg (4 lbs)

**Media specifications**

Maximum print width	104 mm (4.09")
Maximum media width	118 mm (4.65")
Minimum media width	28 mm (1.12")
Maximum media roll diameter	127 mm (5.0")
Media core diameter	25 mm (1.0")
Ribbon wind	Ink side out

**Product order code**

T208M-PRINTER
T208M-C-PRINTER
T2 12M-PRINTER
T2 12M-C-PRINTER

**Description**

Tyco T208M thermal printer – standard
Tyco T208M thermal printer – cutter option
Tyco T2 12M thermal printer – standard
Tyco T2 12M thermal printer – cutter option

**tyco****Electronics**

Printers

**T300 Series High performance, cost effective thermal transfer printers**

Tyco's T300 Series of printers are high performance, yet cost effective thermal transfer printers with a 4.1" print head. The rugged and durable all metal construction makes them suitable for demanding industrial and commercial environments. The enhanced memory and 32 bit processor provide fast data processing and print speeds. Optional accessories are available for added convenience and efficiency.

The T308S and T308S-N have a 200 dpi print head for use with the Tyco range of thermal transfer printable pressure sensitive label products. The T308S-N provides network capability for real time connectivity with the printer. With such connectivity, print jobs can be modified from any location over the Internet via Web-based tools. The T308S-N printer is also capable of sending alerts via e-mail enabled wired or wireless devices.

The 300 dpi print head on the T312S and T312M produces crisp, high quality text, bar codes and graphic images. The T312S is for use with Tyco thermal transfer printable pressure sensitive label products. The T312M is designed for use with Tyco TMS and H.S.I. wire marker sleeves, as well as thermal transfer printable pressure sensitive label products.

**Printer specifications**

Print head width	104 mm (4.09")
Print head resolution	T308S: 8 dpmm (203 dpi) T312M/T312S: 12 dpmm (305 dpi)
Print speed (maximum)	203 mm per second (8 inches per second)
Media sensor	Transmissive – adjustable
Memory	3 MB DRAM and 750 KB flash T308S-N: Additional 8 MB flash memory in PCMCIA socket
Communication interface	Bi-directional parallel port and RS232C/422/485 serial port
Printer dimensions	283 mm W x 495 mm D x 394 mm H (11.2" W x 19.5" D x 15.5" H)
Printer weight	25 kg (55 lbs)

**Media specifications**

Maximum print width	104 mm (4.09")
Maximum media width	115 mm (4.52")
Minimum media width	20 mm (0.79")
Maximum media roll diameter	203 mm (8.0")
Media core diameter	76 mm (3.0")
Ribbon wind	Ink side out

**Product order code**

Product order code	Description
T308S-PRINTER	Tyco T308S thermal printer – standard
T308S-C-PRINTER	Tyco T308S thermal printer – cutter option
T308S-R-PRINTER	Tyco T308S thermal printer – internal rewind option
T308M-PRINTER	Tyco T308M thermal printer – standard
T308S-N-PRINTER	Tyco T308S thermal printer – network capabilities
T312S-PRINTER	Tyco T312S thermal printer – standard
T312S-C-PRINTER	Tyco T312S thermal printer – cutter option
T312S-R-PRINTER	Tyco T312S thermal printer – internal rewind option
T312M-PRINTER	Tyco T312M thermal printer – standard
T312M-R-PRINTER	Tyco T312M thermal printer – internal rewind option

**T400 Series High performance and high speed thermal transfer printers**

The T408M is a high performance, high speed thermal transfer printer with a 5" 203 dpi print head. The rugged and durable all metal construction makes the T408M suitable for demanding industrial and commercial environments.

The enhanced memory and dual 32-bit processor provide extremely fast data processing and print speeds. The T408M is the best option for high volume output and up to 24 hour duty cycles. It is ideal for use with the full range of Tyco TMS and H.S.I. wire marker sleeves and thermal transfer printable pressure sensitive label products. The T408M has a multilingual back-lit LCD display and dual media sensors. Optional accessories are available for added convenience and efficiency.



**Printer specifications**

Print head width	128 mm (5.04")*
Print head resolution	8 dpmm (203 dpi)*
Print speed (maximum)	305 mm per second (12 inches per second)
Media sensor	Transmissive and reflective – adjustable
Memory	16 MB SDRAM and 4 MB flash
Communication interface	Bi-directional parallel port and RS232C/422/485 serial port
Printer dimensions	283 mm W x 495 mm D x 394 mm H (11.2" W x 19.5" D x 15.5" H)
Printer weight	25 kg (55 lbs)

**Media specifications**

Maximum print width	128 mm (5.04")
Maximum media width	140 mm (5.51")
Minimum media width	40 mm (1.57")
Maximum media roll diameter	203 mm (8.0")
Media core diameter	76 mm (3.0")
Ribbon wind	Ink side out

**Product order code**

T408M-PRINTER	Tyco T408M thermal printer – standard
T408M-R-PRINTER	Tyco T408M thermal printer – internal rewind option

**Description**

T400 Series printers are available in wider and higher resolution print heads for specialty identification applications. Please contact your local Tyco Electronics representative for such product configuration requirements.

**T612M-DS Double sided thermal transfer printer**

Specifically designed by Tyco, the T6 12M-DS printer answers a common need in heat-shrinkable wire and cable identification markers: single-pass printing onto both the front and back side of the markers simultaneously. Specifically developed and modified by Tyco for this application, the T6 12M-DS is a high duty cycle, industrially robust thermal transfer printer. It will print onto the complete range of TMS System Six heat-shrinkable markers in all sizes from  $\frac{3}{32}$ " (2.4 mm) to  $2\frac{1}{4}$ " (57.2 mm). The data printed onto the two sides of each marker can be identical or different, same side up or flipped.

**Printer specifications**

Print head width	128 mm (5.04")
Print head resolution	12 dpmm (304 dpi)
Print speed (maximum)	50 to 128 mm per second (2 [recommended] to 5 inches per second)
Media sensor	Transmissive and gap
Memory	12MB DRAM and 1 MB flash
Communication interface	Parallel (centronics) and serial (RS232/422)
Printer dimensions	559 mm W x 432 mm D x 508 mm H (22" W x 17" D x 20" H)
Printer weight	38 kg (84 lbs)

**Media specifications**

Maximum print width	112mm (4.4")
Maximum media width	117 mm (4.625")
Maximum media roll diameter	254 mm (10.0")
Media core diameter	26 mm (3.0")
Ribbon wind	Ink side out

**Product order code**

T612M-DS-PRINTER

**Description**

Tyco T6 12M-DS thermal printer – standard

**AM6310 Heavy duty dot matrix printer**

Specifically designed by Tyco, the AM6310 is a heavy duty industrial dot matrix printer with a high impact 24-pin print head. Automatic media thickness detection and a high impact print head make the AM6310 the best industrial printer available for heavy gauge wire marker and tag materials, and the 24-pin print head produces high quality text printing with fast print speeds. It is ideal for use with the full range of Tyco TMS and H.S.I. wire marker sleeves and dot matrix printable pressure sensitive label and tag products.



**Printer specifications**

Print head	24-pin high-impact dot matrix
Print speed	Max. high-speed draft: 600 cps at 12 cpi Letter quality: 160 cps at 12 cpi
Print direction	Bi-directional, logic seeking
Control panel	LCD, 12 keys, select-dial and quick access setup menu
Feed mechanism	Tractor (single or dual)
Memory	2 MB flash
Input buffer	80 KB
Communication interface	Parallel port (centronics 36-pin) and serial port (RS232/DB25)
Printer dimensions	483 mm W x 427 mm D x 208 mm H 19.0" W x 16.0" D x 8.2" H
Printer weight	18.1 kg (40 lbs)

**Media specifications**

Maximum print width	279 mm (11.0")
Maximum media width	305 mm (12.0")
Minimum media width	25 mm (1.0")

**Product order code**

- AM6310-110V
- AM6310-230V
- AM6310D-110V
- AM6310D-230V

**Description**

- Tyco AM6310 dot matrix printer – standard 110 V
- Tyco AM6310 dot matrix printer – standard 230 V
- Tyco AM6310 dot matrix printer – dual tractor 110 V
- Tyco AM6310 dot matrix printer – dual tractor 230 V

**tyco****Electronics**

Printers

**LQ870 Light duty dot matrix printer**

The LQ870 is a light duty, cost effective dot matrix printer with a 24-pin print head that produces high quality text printing with fast print speeds. The dual tractor feed mechanisms provide stability and reduce waste when printing Tyco wire marker sleeves and label products. The LQ870 is ideal for use with the Tyco range of TMS heat shrinkable wire marker sleeves and dot matrix printable pressure sensitive label products.

**Printer specifications**

Print head	24-pin impact dot matrix
Print speed	Max. high-speed draft: 330 cps at 12 cpi Letter quality: 92 cps at 12 cpi
Feed mechanism	Dual tractor
Input buffer	8 KB
Printer language	ESC/P2
Communication interface	Parallel port
Printer dimensions	457 mm W x 371 mm D x 173 mm H 18.0" W x 14.6" D x 6.8" H
Printer weight	8.9 kg (19.6 lbs)

**Media specifications**

Maximum print width	203 mm (8.0")
Maximum media width	254 mm (10.0")
Minimum media width	51 mm (2.0")

**Product order code****Description**

TMS-743-EP-LQ870-PRNT-KT	Tyco LQ870 dot matrix printer – standard 110 V
TMS-SIX-PROMO-PRINTER	Tyco LQ870 dot matrix printer – standard 240 V



**LMS-9000 Laser marker**

The LMS-9000 laser marker is a low maintenance laser marking system designed for high volume users. It is a highly automated system including cutting to length, postmark rewinding and double sided, one step sleeve marking.

Integrated with WinTotal marker sleeve/label marking software, it is designed for Tyco wire identification sleeves and selected labels.

**Features and benefits**

- Simultaneous double-sided laser marking option for marker sleeves saves considerable time and eliminates any margin for error.
- Optional handling system designed to handle several Tyco products.
- Laser marking and cutting for kitting in one integrated step eliminates post print cutting and kitting.
- Virtually no product wastage during marking, thanks to a state of the art product recognition and jogging system.
- Optional scoring and marking feature for label products.
- Modular design for easy placement and re-installation.
- Fully integrated software and hardware.
- On screen diagnostics.
- Meets all relevant US and European laser equipment standards.
- Laser parameters pre-set and software controlled.



<b>Product order code</b>	<b>Description</b>
LMS-9000	Tyco LMS-9000 laser – standard <i>*Please contact your local Tyco representative for product configuration per your application.</i>

**tyco**

Electronics

## Ribbons

**Thermal transfer ribbons****RJS-4RPSCE**

Tyco RJS-4RPSCE is a high durability black resin thermal transfer ribbon tested and approved for use on Tyco TMS-SCE and RPS wire marker sleeve products. For guaranteed print performance and durability use with Tyco recommended compatible printers.

**General specifications**

Ribbon width	114 mm (4.5 inches)
Ribbon length	300 meters (984 feet)
Ink	Resin
Standard color	Black
Ribbon wind direction	Ink side out
Compatible printers	T312M, T408M, T612M-DS
Compatible materials	TMS-SCE, RPS

*\* Available in additional sizes and colors by custom quotation*

**Ordering information**

Product order code	TMS-RJS-RIBBON-4RPSCE
Description	Tyco 4RPSCE thermal transfer ribbon for T312M, T408M and T612M-DS printers

**101-4RPSCE**

Tyco 101-4RPSCE is a high durability black resin thermal transfer ribbon tested and approved for use on Tyco TMS-SCE and RPS wire marker sleeve products. For guaranteed print performance and durability use with Tyco recommended compatible printers.

**General specifications**

Ribbon width	110 mm (4.33 inches)
Ribbon length	91 meters (300 feet)
Ink	Resin
Standard color	Black
Ribbon wind direction	Ink side out
Compatible printers	T208M, T212M
Compatible materials	TMS-SCE, RPS, EP

**Ordering information**

Product order code	TMS-101-RIBBON-4RPSCE
Description	Tyco 4RPSCE thermal transfer ribbon for T208M and T212M printers

**RJS-4HT**

Tyco RJS-4HT is a high temperature black resin thermal transfer ribbon tested and approved for use on Tyco HT-SCE high temperature wire marker sleeve products. For guaranteed print performance and durability use with Tyco recommended compatible printers.

**General specifications**

Ribbon width	114 mm (4.5 inches)
Ribbon length	300 meters (984 feet)
Ink	Resin
Standard color	Black
Ribbon wind direction	Ink side out
Compatible printers	T312M, T408M, T612M-DS
Compatible materials	HT-SCE, HTCM-SCE (T312M only)

**Ordering information**

Product order code	TMS-RJS-RIBBON-4HT
Description	Tyco 4HT thermal transfer ribbon for T312M, T408M and T612M-DS printers

**101-4HT**

Tyco 101-4HT is a high temperature black resin thermal transfer ribbon tested and approved for use on Tyco HT-SCE high temperature wire marker sleeve products. For guaranteed print performance and durability use with Tyco recommended compatible printers.

Ribbons

**Thermal transfer ribbons (Cont'd)**

**General specifications**

Ribbon width	114 mm (4.5 inches)
Ribbon length	100 meters (328 feet)
Ink	Resin
Standard color	Black
Ribbon wind direction	Ink side out
Compatible printers	T208M, T212M
Compatible materials	HT-SCE

**Ordering information**

Product order code	TMS-101-RIBBON-4HT
Description	Tyco 4HT thermal transfer ribbon for T208M and T212M printers

**RJS-4ZH**

Tyco RJS-4ZH is a high durability black resin thermal transfer ribbon tested and approved for use on Tyco ZH-SCE zero halogen wire marker sleeve products. For guaranteed print performance and durability use with Tyco recommended compatible printers.

**General specifications**

Ribbon width	110 mm (4.33 inches)
Ribbon length	300 meters (984 feet)
Ink	Resin
Standard color	Black
Ribbon wind direction	Ink side out
Compatible printers	T312M, T408M, T612M-DS
Compatible materials	ZH-SCE

**Ordering information**

Product order code	TMS-RJS-RIBBON-4ZH
Description	Tyco 4ZH thermal transfer ribbon for T312M, T408M and T612M-DS printers

**T200-4ZH**

Tyco 101-4ZH is a high durability black resin thermal transfer ribbon tested and approved for use on Tyco ZH-SCE zero halogen wire marker sleeve products. For guaranteed print performance and durability use with Tyco recommended compatible printers.

**General specifications**

Ribbon width	110 mm (4.33 inches)
Ribbon length	91 meters (300 feet)
Ink	Resin
Standard color	Black
Ribbon wind direction	Ink side out
Compatible printers	T208M, T212M
Compatible materials	ZH-SCE

**Ordering information**

Product order code	T200-RIBBON-4ZH
Description	Tyco 4ZH thermal transfer ribbon for T208M and T212M printers

**1910**

Tyco 1910 is a high durability high contrast resin/wax thermal transfer ribbon tested and approved for use on the HLX-zero halogen cable marker tape and the HXTM-FB rail tags. For guaranteed print performance use with Tyco recommended printers.

**General specifications**

Ribbon width	110 mm (4.33 inches)
Ribbon length	300 meters (984 feet)
Ink	Resin/wax
Standard color	Black
Ribbon wind direction	Ink side out
Compatible printers	T312M, T408M
Compatible materials	HLX, HXTM-FB

**Ordering information**

Product order code	1910-RIBBON-4T300
Description	Tyco 1910 thermal transfer ribbon for T312M and T408M printers

**tyco**

Electronics

## Ribbons

**Thermal transfer ribbons (Cont'd)****1950**

Tyco 1950 is a high durability black resin/wax thermal transfer ribbon tested and approved for use on Tyco thermal transfer printable H.S.I. wire marker sleeves and HL cable marker products. See right for compatible materials. For guaranteed print performance and durability use with Tyco recommended compatible printers.

**General specifications**

Ribbon width	110 mm (4.33 inches)
Ribbon length	300 meters (984 feet)
Ink	Resin/wax
Standard color	Black
Ribbon wind direction	Ink side out
Compatible printers	T312M, T612M-DS
Compatible materials	D-SCE, HC, HL, HLX, HS, HX

**Ordering information**

Product order code	1950-RIBBON-4T300
Description	Tyco 1950 thermal transfer ribbon for T312M and T612M-DS printers

**3300**

Tyco 3300 is a high durability black resin thermal transfer ribbon tested and approved for use on Tyco thermal transfer printable pressure sensitive labels. See right for compatible materials. For guaranteed print performance and durability use with Tyco recommended compatible printers.

**General specifications**

Ribbon width*	110 mm (4.33 inches)
Ribbon length*	300 meters (984 feet)
Ink	Resin
Standard color*	Black
Ribbon wind direction	Ink side out
Compatible printers	T308S, T312S, T312M, T408M
Compatible materials	CP, HM, HPK, HW, MP, MV, NC, PVF, SB, TN, TTP, TTVF, WP, WV

\*Available in additional sizes and colors by custom quotation

**Ordering information**

Product order code	1330-3300-10
Description	Tyco 3300 thermal transfer ribbon for all T300 and T400 printers

**3300-101TT**

Tyco 3300-101TT is a high durability black resin thermal transfer ribbon tested and approved for use on Tyco thermal transfer printable pressure sensitive labels. See right for compatible materials. For guaranteed print performance and durability use with Tyco recommended compatible printers.

**General specifications**

Ribbon width*	110 mm (4.33 inches)
Ribbon length*	91 meters (300 feet)
Ink	Resin
Standard color*	Black
Ribbon wind direction	Ink side out
Compatible printers	T208M, T212M
Compatible materials	CP, HM, HPK, HW, MP, MV, NC, PVF, SB, TN, TTP, WP, WV

\*Available in additional sizes and colors by custom quotation

**Ordering information**

Product order code	1330-3300-101TT
Description	Tyco 3300 thermal transfer ribbon for T208M and T212M printers

### RHD

Tyco RHD is a high durability black resin thermal transfer ribbon tested and approved for use on Tyco thermal transfer printable pressure sensitive labels. See right for compatible materials. For guaranteed print performance and durability use with Tyco recommended compatible printers.

## Ribbons

### Thermal transfer ribbons (Cont'd)

#### General specifications

Ribbon width*	110 mm (4.33 inches)
Ribbon length*	300 meters (984 feet)
Ink	Resin
Standard color*	Black
Ribbon wind direction	Ink side out
Compatible printers	T308S, T312S, T312M, T408M
Compatible materials	CP, HM, HPK, HW, MP, MV, NC, PVF, TN, TTP, WP

\* Available in additional sizes and colors by custom quotation

#### Ordering information

Product order code	1330-0607-10
Description	Tyco RHD thermal transfer ribbon for all T300 and T400 printers

### RHT

Tyco RHT is a high temperature black resin thermal transfer ribbon tested and approved for use on Tyco thermal transfer printable Kapton® labels. See right for compatible materials. For guaranteed print performance and durability use with Tyco recommended compatible printers.

#### General specifications

Ribbon width*	110 mm (4.33 inches)
Ribbon length*	300 meters (984 feet)
Ink	Resin
Standard color*	Black
Ribbon wind direction	Ink side out
Compatible printers	T308S, T312S, T312M, T408M
Compatible materials	T1K, T2K, TAK, TSK, T2Y

\* Available in additional sizes and colors by custom quotation

#### Ordering information

Product order code	1330-0619-10
Description	Tyco RHT thermal transfer ribbon for all T300 and T400 printers

### RS

Tyco RS is a high quality black wax thermal transfer ribbon tested and approved for use on Tyco thermal transfer printable paper labels. See right for compatible material. For guaranteed print performance and durability use with Tyco recommended compatible printers.

#### General specifications

Ribbon width*	110 mm (4.33 inches)
Ribbon length*	300 meters (984 feet)
Ink	Wax
Standard color*	Black
Ribbon wind direction	Ink side out
Compatible printers	T308S, T312S, T312M, T408M
Compatible materials	EP

\* Available in additional sizes and colors by custom quotation

#### Ordering information

Product order code	1330-0600-10
Description	Tyco RS thermal transfer ribbon for all T300 and T400 printers

### T300-WH

White resin based ribbons are available to print on Tyco Electronics TMS-SCE wire marker sleeve products. For print performance and durability use with Tyco Electronics recommended compatible printers.

#### General specifications

Ribbon width*	110 mm (4.33 inches)
Ribbon length*	300 meters (984 feet)
Ink	Resin
Standard color*	White
Ribbon wind direction	Ink side out
Compatible printers	T308M, T312M
Compatible materials	TMS-SCE, HM, MP, MV, TTP

#### Ordering information

Product order code	T300-RIBBON-WH
Description	Tyco thermal transfer white ribbon for all T308M, T312M and T408M printers

**tyco***Electronics*

## Ribbons

**Thermal transfer ribbons (Cont'd)****T200-WH**

White resin based ribbons are available to print on Tyco Electronics TMS-SCE wire marker sleeve products. For print performance and durability use with Tyco Electronics recommended compatible printers.

**General specifications**

Ribbon width*	110 mm (4.33 inches)
Ribbon length*	70 meters (230 feet)
Ink	Resin
Standard color*	White
Ribbon wind direction	Ink side out
Compatible printers	T208M, T212M
Compatible materials	TMS-SCE, HM, MP, MV, TTP

**Ordering information**

Product order code	TMS-101-RIBBON-WH-SCE
Description	Tyco thermal transfer white ribbon for T200 printers

**T300-WH-4HT**

White resin based ribbons are available to print on Tyco Electronics HT-SCE wire marker sleeve products. For print performance and durability use with Tyco Electronics recommended compatible printers.

**General specifications**

Ribbon width*	114 mm (4.49 inches)
Ribbon length*	300 meters (984 feet)
Ink	Resin
Standard color*	White
Ribbon wind direction	Ink side out
Compatible printers	T308M, T312M, T408M
Compatible materials	HT-SCE

**Ordering information**

Product order code	T300-RIBBON-WH-4HT
Description	Tyco thermal transfer white ribbon for all T308M, T312M and T408M printers

**T200-WH-4HT**

White resin based ribbons are available to print on Tyco Electronics HT-SCE wire marker sleeve products. For print performance and durability use with Tyco Electronics recommended compatible printers.

**General specifications**

Ribbon width*	110 mm (4.33 inches)
Ribbon length*	91 meters (298 feet)
Ink	Resin
Standard color*	White
Ribbon wind direction	Ink side out
Compatible printers	T208M, T212M
Compatible materials	HT-SCE

**Ordering information**

Product order code	T200-RIBBON-WH-4HT
Description	Tyco thermal transfer white ribbon for T200 printers

**Thermal transfer ribbons (Cont'd)**

**RHCA**

RHCA resin based ribbons are specifically designed to print on polyester or metalized polyester Tyco Electronics label products. For print performance and durability use with Tyco Electronics recommended compatible printers. It is not suitable to print on paper or self-laminating products.

**General specifications**

Ribbon width*	110 mm (4.33 inches)
Ribbon length*	91 meters (300 feet)
Ink	Resin
Standard color*	Red, Blue and Green (see ordering information below)
Ribbon wind direction	Ink side out
Compatible printers	T308S, T308M, T312S, T312M and T408M
Compatible materials	HM, HPK, MP, MV, PVF, WP, WV

**Ordering information**

Product order codes	1330-0620-10 (Red)	1330-0621-10 (Blue)	1330-0622-10 (Green)
Description	Tyco thermal transfer color ribbon for all T300 and T400 printers		

**RHCB**

RHCB wax-resin based ribbons are specifically designed to print on paper and self-laminating Tyco Electronics label products. For print performance and durability use with Tyco Electronics recommended compatible printers.

**General specifications**

Ribbon width*	110 mm (4.33 inches)
Ribbon length*	300 meters (9840 feet)
Ink	Wax-Resin
Standard color*	Red, Blue and Green (see ordering information below)
Ribbon wind direction	Ink side out
Compatible printers	T308S, T308M, T312S, T312M and T408M
Compatible materials	EP, SB

**Ordering information**

Product order codes	1330-0630-10 (Red)	1330-0631-10 (Blue)	1330-0632-10 (Green)
Description	Tyco thermal transfer color ribbon for all T300 and T400 printers		

**tyco***Electronics*

## Ribbons

**Dot matrix ribbons****RIBBON A**

Tyco RIBBONA is a permanent black ink dot matrix ribbon tested and approved for use on Tyco TMS-SCE wire marker sleeves and RMK-6 products on the LQ870 printer. See right for compatible materials.

**General specifications**

Ink	Standard
Standard color	Black
Compatible printer	LQ870
Compatible materials	CM-SCE, D-SCE, RMK-6, RPS, TMS-SCE

**Ordering information**

Product order code	TMS-SYSTEM-SIX-RIBBON-A
Description	Tyco dot matrix Ribbon A for LQ870 printer

**RIBBON D**

Tyco RIBBOND is a high performance, permanent black ink dot matrix ribbon tested and approved for use on Tyco TMS-SCE wire marker sleeve products on the LQ870 printer. See right for compatible materials.

**General specifications**

Ink	High performance
Standard color	Black
Compatible printer	LQ870
Compatible materials	CM-SCE, D-SCE, RPS, TMS-SCE

**Ordering information**

Product order code	TMS-SYSTEM-SIX-RIBBON-D
Description	Tyco dot matrix Ribbon D for LQ870 printer

**QUICK-DRY LQ870**

Tyco QUICK-DRYLQ870 is a quick drying indelible black ink dot matrix ribbon tested and approved for use on Tyco dot matrix printable pressure sensitive labels on the LQ870 printer. See right for compatible materials.

**General specifications**

Ink	RI Quick-Dry
Standard color	Black
Compatible printer	LQ870
Compatible materials	C, DMVF, E, HLTM, K, M, NMX, PV, TW

**Ordering information**

Product order code	1330-0037-00
Description	Tyco Quick-Dry dot matrix ribbon for LQ870 printer



**Dot matrix ribbons****STANDARD AM6310**

Tyco STANDARD AM6310 is a permanent black ink dot matrix ribbon tested and approved for use on Tyco wire marker sleeves and cable marker products on the AM6310 printer. See right for compatible materials.

**General specifications**

Ink	Standard
Standard color	Black
Compatible printer	AM6310
Compatible materials	CM-SCE, D-SCE, HC, HL, HLTM-FB, HM, HS, RMK-6, RPS, TMS-SCE

**Ordering information**

Product order code	1892BK04-RIBBON
Description	Tyco standard dot matrix ribbon for AM6310 printer

**HIGH-PERF AM6310**

Tyco HIGH-PERF AM6310 is a high performance, permanent black ink dot matrix ribbon tested and approved for use on Tyco wire marker sleeves and cable marker products on the AM6310 printer. See right for compatible materials.

**General specifications**

Ink	High performance
Standard color	Black
Compatible printer	AM6310
Compatible materials	CM-SCE, D-SCE, HC, HL, HLTM-FB, HL, HM, HS, HX, RMK-6, TMS-SCE

**Ordering information**

Product order code	1892BK03-HIGH-PERF-RIBBON
Description	Tyco high performance dot matrix ribbon for AM6310 printer

**QUICK-DRY AM6310**

Tyco QUICK-DRY AM6310 is a quick drying indelible black ink dot matrix ribbon tested and approved for use on Tyco dot matrix printable pressure sensitive labels on the AM6310 printer. See right for compatible materials.

**General specifications**

Ink	RI Quick-Dry
Standard color	Black
Compatible printer	AM6310
Compatible materials	C, DMVF, E, HLTM, HPC, HPTM, K, M, NMX, PV, TW

**Ordering information**

Product order code	1892BK01
Description	Tyco Quick-Dry dot matrix ribbon for AM6310 printer

**WinTotal Wire marker and label printing software**

WinTotal software is a powerful 32-bit label/marker design package that makes wire marker printing simple in an industrial environment. Running in the familiar Windows environment, the package is pre-loaded with all the Tyco wire identification products to facilitate marker design. The software features a highly graphical user interface to simplify operator training and minimize errors. The Windows environment gives access to a huge array of font options, including non-English fonts such as Chinese, Japanese and Hebrew (when used with appropriate operating systems or add-on software), and also allows simple importing and manipulation of graphics and logos. Bar code printing is available.

WinTotal software supports all common wire identification needs, including:

- Manual printing
- Automatic set printing from spreadsheets, databases or other CAD systems (including Tyco's HamWare™ harness design software package)
- Incremental alpha and numeric fields
- Double-sided marker printing
- Automatic or manual routing or multiple printers
- Paper output option
- Wraparound marker production
- User-defined products
- Programmable buttons for repeated data insertion

The software can be password protected at different levels to prevent unauthorized use, and can be run on networked computers so that the design function can be separated from printing. The display can be set to several different languages, and a full on-screen Help function is incorporated.

Running behind the simple WinTotal user interface is a powerful label-making package, so the software can be used to design and print general labeling applications such as rating plates and shipping labels.

**Features and benefits**

- Powerful wire marker design and print software.
- Familiar Windows user environment.
- Pre-loaded with Tyco identification products.
- Powerful import and export functions: reads wire lists from spreadsheets, databases and text files from CAD systems.
- Printer multi-tasking.
- Multiple on-screen languages.



**WinTotal Wire marker and label printing software (Cont'd)**

**Label design**

- WYSIWYG label design and display.
- Align text left, right, justified or center.
- Built-in printer font support.
- Windows True Type fonts.
- Lines, boxes and graphic images.
- Resize, rotate and stretch text, graphics and bar codes.
- Thumbnail preview of saved labels.

**Printing**

- Set and batch printing capabilities.
- Multiple application port printing (MAPP).
- Double sided marker printing.
- Local or network printer support.
- Number of identical or serialized copies selectable from database.

**Serialization**

- Increment or decrement by any interval.
- Numeric, alphanumeric and custom base serialization.

**Database options**

- Microsoft ODBC support, including: Access, Excel and dBase.
- ASCII text files.
- AutoCad importing.

**Data management**

- Visual Basic scripting for custom data processing.
- Shareable data fields.
- Multiple products within one set or batch.

**Minimum recommended computer configuration**

Computer	IBM-compatible PC
Processor	Intel Pentium® processor, 400 MHz minimum
RAM	64 MB minimum (128 MB for Windows NT and 2000)
Operating system	Windows 95, 98, ME or NT
Disk space required	15 MB minimum

**Other technical information**

Barcode types	Codabar, code 39, code 93, code 128, EAN-13, EAN-8, UPC-E, Interleaved 2/5, ITF (DUN 14)
Company logo or graphics	Can be imported in BMP, PCX, MSP, WMF, JPG, JIF, GIF formats
Text and graphics	Can be rotated, moved or resized

**Ordering information**

Ordering description	Product description
TMS-WINTOTAL-SWARE	Tyco Wire Marker Printing Software – Windows, 32 bit

**tyco****Electronics**

Software

**PrintEasy Label printing software**

Tyco PrintEasy is a powerful yet easy to use Windows based label design and printing software. With PrintEasy you can quickly and easily combine bar codes, text and graphics into professional quality labels. Carefully organized menus and pop-up dialogs display all your options in plain, easy to understand words. The true WYSIWYG display allows you to create and view your labels with precision, giving you total control over your labels' appearance before printing. PrintEasy is ideal for use with the Tyco range of thermal transfer printable pressure sensitive label products. PrintEasy is pre-loaded with all of Tyco's standard thermal transfer label templates, which allows you to simply select the Tyco part number you want to print and you are ready to go!

**Features & benefits****Support**

- Free technical support.
- OS Support: Windows 95, 98, ME, NT, 2000, XP.
- International language support.

**Label design**

- True WYSIWYG label design and display.
- Built-in printer font support.
- Windows True Type fonts.
- Reverse (white on black) text printing.
- Align text left, right, justified or center.
- Unlimited Undo/Redo command.
- Lines, boxes and graphic images.
- Import graphics in BMP, JPG, TIF, PCX, DCX, DIB, EPS and others.
- Resize, rotate and stretch objects.
- Thumbnail preview of saved labels.
- Metric and US measurement systems.

**Bar codes**

- Numerous 1D and 2D symbologies.
- Unlimited width and height.
- Sequentially numbered bar codes.
- Place characters above or below bar codes or do not print.
- Option to display Start/Stop characters.

**Printing**

- Printer-based bar codes and serial numbers.
- Speed optimization using repetitive data control.
- Local or network printer support.
- Performance-enhancing printer controlled serialization.
- Number of identical or serialized copies selectable from data-base.

**PrintEasy Label printing software** (Cont'd)**Serialization**

- Increment or decrement by any interval.
- Separate Rollover/Rollunder and Value Reset options.
- Preserve or expand field length when rolling over.
- Numeric, alphanumeric and custom base serialization.

**Database options**

- Microsoft ODBC support, including: Access, Btrieve, dBase, Excel, Oracle, Paradox, Clipper, FoxPro, Interbase and more.
- ASCII text files.
- SAP (mySAP.com and R/3).
- Versatile multiple-table data access.
- Import variable graphics from databases.
- Data query wizard.
- Individual record-picking at print time.

**Data management**

- Visual Basic scripting for custom data processing.
- User-definable minimum and maximum field lengths.
- Customizable data-entry filters and error checking.
- Multi-data source selection per label object.
- Easy entry of special and unprintable control characters.
- Shareable data fields.
- Customizable message box handling.

**Integration**

- Command line interface option.
- Pre-loadable into "background" to avoid start-up delays.
- Dynamically selectable label formats and data sources.
- Error logging.

**Ordering information**

Ordering description	Product description
BT32-PRO	Tyco BT Label Printing Software – Windows, 32-bit Pro Version, full thermal transfer support
TTS 03/N05	Tyco Enhanced Label Printing Software – Network Version

- PrintEasy – Pro Tyco label printing software - Windows, 32-bit, Professional Version  
 PrintEasy – Suite Tyco label printing software - Windows, 32-bit, Suite Version  
 PrintEasy – Net05 Tyco labelprinting software - Windows, 32-bit, 5-user Network Version

**tyco****Electronics**

Application Systems

**Hot Air Gun**

The Tyco Hot Air Gun is an electronic heating tool with adjustable heat settings from +49°C to +593°C (+120°F to +1100°F), and automatic temperature control for precise temperature output. It is ideal for use with the Tyco range of TMS and H.S.I. heat shrinkable wire marker sleeves. This HotAirGun is lightweight in design with easy, quiet operation. The ceramic encapsulated heating element provides exceptional durability and long life.

Optional accessories are available for added convenience and efficiency.

**Specifications**

120 V power requirement	120 V, 60 Hz, 12.5 A
230 V power requirement	230 V, 50 Hz, 8.7 A
Rated heater element power	1500 W
Weight	850 g (1.9 lb)
Cord length	2.4 m (8 ft)
Typical temperature output	+49°C to +593°C    +120°F to +1100°F

**Optional accessories and replacement parts**

HL1802E-BENCH-STD	Bench stand, clip-on.
HL1802E-074616	Reflector nozzle, for small diameter sleeves/tubing
HL1802E-070519	Reflector nozzle, for large diameter sleeves/tubing
HL1802E-070618	Reduction nozzle (9 mm), for pinpoint air-flow control

**Ordering description    Product description**

HL1802E-KIT-120V	Hot air gun kit, 120 V power/reflector accessory (small)
HL1802E-KIT-230V	Hot air gun kit, 230 V power /reflector accessory (small)







Electronics

PRE-PRINT SERVICES

Pre-Print Services .....129



PERMARK®

Permark® .....130



RAIL—SIGNAL PRODUCTS

HPTM Fabric .....132  
HPKTM Polypropylene .....134  
HLTM-FB/HXTM-FB Polyolefin .....136



APPLICATION SYSTEMS

TP Tape .....138





**Preprinted bar code labels**



Since 1986 we've met the diverse needs of commercial, industrial, governmental and institutional customers by providing innovative solutions to their unique bar code label requirements. Solutions include custom sizes, colors, graphics, laminations, special adhesives, die-cuts and original creative designs.

**Quality materials**

Tyco Electronics Identification buys master rolls of label stock and converts it to meet the needs of our customers. Our purchasing power, combined with our converting capabilities, allows us to provide the highest quality materials at great prices.

**Sequential number tracking**

If your application requires sequential numbering, Tyco will keep an automated log of sequence numbers printed for each order. Even if you have an assortment of labels, multiple locations, or use subcontractors to produce your product, we will insure that there are no duplicate numbers printed — guaranteed!

**Production proofs**

For every new label job, Tyco will provide a paper copy/electronic proof of your label prior to running the job. This allows you to review and approve the size, layout and graphics on the label prior to a full production run.

**20 step quality check**

Tyco enforces more than 20 quality checks during the manufacturing and quality assurance processes: these quality checks include many automated tests with state of the art equipment. We test every roll of labels for readability, accuracy and scan rates and we will not ship any labels that do not pass our quality assurance tests.

For more information, contact a Tyco customer service representative at:

**US** 1-800-430-7226  
**Europe** +44(0) 1495 244 000

**High Temperature Harsh Environment Circuit Board**

**Pallet/Carton**

**Product ID**

**Security**

**Asset Tag**

**Vertical Rack**

**Signs & Magnetic Labels Also Available**

Tyco Permark 316 stainless steel markers are recommended for marking in hostile environments. Using state-of-the-art technology and no inks, the marking process produces a permanent, deep surface mark with a darkened character in high contrast to the background. Permark® markers are produced to individual customer requirements on a fast turn-around basis with the flexible and easy-to-use Permark software that allows electronic or manual data entry. Completed markers are supplied in customer defined kits for ease of installation. We recommend installation with 316 stainless steel cable ties.

**Features and benefits**

- Pre-marked to customer requirements.
- Customer-defined kits for ease of installation.
- Excellent character legibility.
- One-piece, 316 stainless steel construction.
- Variety of fixing methods.
- Mark will endure the lifetime of a Permark S/S marker.
- Excellent resistance to weather extremes and high levels of UV light.
- Resistant to corrosive marine and industrial atmospheres.
- Excellent resistance to a variety of hydrocarbons, organic chemicals, acids, alkalis and inorganic salts. For resistance to a specific chemical, contact your local Tyco representative.



**Temperature rating**

Operating temperature range    -80°C to +500°C    -112°F to +932°F

**Printer information**

Pre-printed per customer requirements.

**Part numbering system**

PM 0 7507-1-4-5



**Available sizes and formats**

Ordering description	Product description	Size (L x H)		Printable area (L x H)	
		mm	inches	mm	inches
PM095 12-<# text lines><font height><# characters>	Pre-marked 316 S/S marker	95 x 12	3.74 x 0.47	55 x 10	2.16 x 0.40

**Options**

Fonts	Various available
Lines per marker	One, two or three (Determined by selected font height. Minimum 1 mm / 0.04" spacing between lines.)
Saddle fixings	13 mm L x 2.4 mm H (0.51" L x 0.09" H)
Hole fixings	7 mm (0.28")
Standard colors	Metallic

Font heights	Characters per line	
	Standard	Condensed
2.5 mm (0.10")	30	N/A
3.0 mm (0.12")	25	N/A
4.0 mm (0.16")	20	30
5.0 mm (0.20")	15	25
6.0 mm (0.24")	15	25
8.0 mm (0.31")	10	20
10.0 mm (0.40")	10	15

**Available sizes and formats**

Ordering description	Product description	Size (L x H)		Printable area (L x H)	
		mm	inches	mm	inches
PM07507-1-<font height><# characters>	Pre-marked 316 S/S marker	75 x 7	2.95 x 0.28	50 x 5	1.6 x 0.20

**Options**

Fonts	Various available
Lines per marker	One only
Saddle fixings	9.5 mm L x 2.4 mm H (0.37" L x 0.09" H)
Hole fixings	None
Standard colors	Metallic

Font heights	Characters per line	
	Standard	Condensed
4.0 mm (0.16")	15	25
5.0 mm (0.20")	10	20

**HPTM Adhesive rail terminal tags for dot matrix printing**

Tyco HPTM is a specially formulated heavy gauge fabric material with a high tack permanent acrylic adhesive, designed for applications in control panel backboards for rail signal circuit identification.

The standard 1.0" hole pitch design meets AAR terminal post specifications and makes installation fast and convenient.

HPTM adheres to most smooth surfaces including bare and painted metal, as well as painted plywood used for rail signal terminal boards. It is resistant to common fluids, lubricants and solvents.

For guaranteed print performance and durability, use with Tyco's RI Quick-Dry series ribbon.

**Features and benefits**

- Specially formulated fabric material with exceptional tear strength.
- Dot matrix printable.
- Performance exceeds military specifications.
- High-performance acrylic adhesive.

**Temperature rating**

Operating temperature range	-40°C to +80°C	-40°F to +176°F
Minimum application temperature	+10°C	+50°F

**Specifications/approvals**

Military	SAE AS81531 4.6.2 MIL-STD-202F method 215J
Industry	AAR Terminal Post

**Printer information**

Tyco printer	AM6310 (dot matrix)
Tyco ribbon	1892BK04 (dot matrix) 1892BK03 (dot matrix – high performance)

**Part numbering system**

**Ordering information**



**Available sizes and formats**

Ordering description	Hole position	(A) Tag width		(B) Tag height		(C) Vertical repeat		(D) Web width		(E) Hole diameter	
		mm	<i>inches</i>	mm	<i>inches</i>	mm	<i>inches</i>	mm	<i>inches</i>	mm	<i>inches</i>
HPTM1CL-312	Left	38.10	<i>1.500</i>	25.40	<i>1.000</i>	25.40	<i>1.000</i>	76.20	<i>3.000</i>	7.90	<i>0.312</i>
HPTM1CR-312	Right	38.10	<i>1.500</i>	25.40	<i>1.000</i>	25.40	<i>1.000</i>	76.20	<i>3.000</i>	7.90	<i>0.312</i>
HPTM1CL-438	Left	38.10	<i>1.500</i>	25.40	<i>1.000</i>	25.40	<i>1.000</i>	76.20	<i>3.000</i>	11.10	<i>0.438</i>
HPTM1CR-438	Right	38.10	<i>1.500</i>	25.40	<i>1.000</i>	25.40	<i>1.000</i>	76.20	<i>3.000</i>	11.10	<i>0.438</i>
HPTM1CL-500	Left	38.10	<i>1.500</i>	25.40	<i>1.000</i>	25.40	<i>1.000</i>	76.20	<i>3.000</i>	12.70	<i>0.500</i>
HPTM1CR-500	Right	38.10	<i>1.500</i>	25.40	<i>1.000</i>	25.40	<i>1.000</i>	76.20	<i>3.000</i>	12.70	<i>0.500</i>

**Options**

Package sizes	Standard	1000 piece pack
Colors	Standard	White

**HPKTM Adhesive-backed polypropylene tags for thermal transfer printing**

Tyco HPKTM is a semi-rigid polypropylene film with a permanent acrylic adhesive that is designed for application to control panel backboards for rail signal circuit identification. The standard 1.0" hole pitch design meets AAR terminal post specifications and makes installation fast and convenient. HPKTM adheres to most smooth surfaces including bare and painted metal, as well as painted plywood used for rail signal terminal boards. It is resistant to common fluids, lubricants and solvents. For guaranteed print performance and durability, use with Tyco's RHD series ribbon.

**Features and benefits**

- Self-adhesive backing for quick and easy fixing.
- Thermal transfer printable.
- Recommended for indoor use.
- Resistant to common fluids, lubricants and solvents.



**Temperature rating**

Operating temperature range      -29°C to +80°C      -24°F to +176°F

**Specifications/approvals**

Industry      AAR Terminal Post

**Printer information**

Tyco printer      T308S\* (thermal transfer)  
 Tyco ribbon      1330-0607-10\* (thermal transfer)

*\*Alternative printers and ribbons are available for special applications. Contact Tyco Electronics Identification for more information.*

**Part numbering system**

HPKTM 1C L - 312



Ordering information



Available sizes and formats

Ordering description	Hole position	(A) Tag width		(B) Tag height		(C) Vertical repeat		(D) Web width		(E) Hole diameter	
		mm	<i>inches</i>	mm	<i>inches</i>	mm	<i>inches</i>	mm	<i>inches</i>	mm	<i>inches</i>
HPKTM1CL-312	Left	38.10	<i>1.500</i>	25.40	<i>1.000</i>	25.40	<i>1.000</i>	76.20	<i>3.000</i>	7.90	<i>0.312</i>
HPKTM1CR-312	Right	38.10	<i>1.500</i>	25.40	<i>1.000</i>	25.40	<i>1.000</i>	76.20	<i>3.000</i>	7.90	<i>0.312</i>
HPKTM1CL-438	Left	38.10	<i>1.500</i>	25.40	<i>1.000</i>	25.40	<i>1.000</i>	76.20	<i>3.000</i>	11.10	<i>0.438</i>
HPKTM1CR-438	Right	38.10	<i>1.500</i>	25.40	<i>1.000</i>	25.40	<i>1.000</i>	76.20	<i>3.000</i>	11.10	<i>0.438</i>
HPKTM1CL-500	Left	38.10	<i>1.500</i>	25.40	<i>1.000</i>	25.40	<i>1.000</i>	76.20	<i>3.000</i>	12.70	<i>0.500</i>
HPKTM1CR-500	Right	38.10	<i>1.500</i>	25.40	<i>1.000</i>	25.40	<i>1.000</i>	76.20	<i>3.000</i>	12.70	<i>0.500</i>

Additional sizes and formats available by custom quotation.

Options

Package size	1,000 piece pack	
Colors	Standard	White

**HLTM-FB / HXTM-FB Non-adhesive-backed polyolefin tags for thermal or dot matrix printing**

Tyco HLTM-FB/HXTM-FB is a semi-rigid, heavy gauge crosslinked polyolefin material without an adhesive backing, designed for use in a variety of applications including terminal post and terminal board signal circuit identification. The heavy gauge thickness is ideal for applications requiring exceptional durability. Mark permanence exceeds military requirements. They are resistant to common fluids, lubricants, solvents and abrasion. For guaranteed print performance and durability, use with Tyco approved printers and ribbons.

**Features and benefits**

- Specially formulated polyolefin material.
- Flame retarded.
- Resistant to common fluids, lubricants and solvents.
- Dot matrix (HLTM-FB) or thermal transfer (HXTM-FB) printable.
- Print performance exceeds military standards.

**Temperature rating**

Operating temperature range		
HLTM-FB	-55°C to +135°C	-67°F to +275°F
HXTM-FB	-30°C to +105°C	-22°F to +221°F

**Specifications/approvals**

Military	SAE AS81531 4.6.2
	MIL-STD-202F Method 215J

**Printer information**

Tyco printer	HLTM-FB	AM6310* (dot matrix)
	HXTM-FB	T312M (thermal transfer)
Tyco ribbon	HLTM-FB	1892BK04* (dot matrix)
	HXTM-FB	1910-RIBBON-4T300 (thermal transfer)

*\*Alternative printers and ribbons are available for special applications. Contact Tyco Electronics Identification for more information.*

**Part numbering system****HLTM1FBWE-312**

Hole diameter

Color

Product family



**Ordering information**

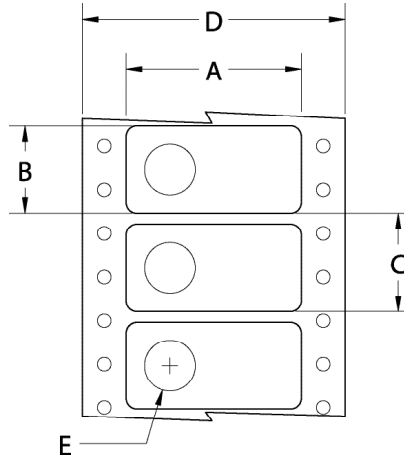

**Available sizes and formats**

Ordering description	Hole position	(A) Tag width		(B) Tag height		(C) Vertical repeat		(D) Web width		(E) Hole diameter	
		mm	<i>inches</i>	mm	<i>inches</i>	mm	<i>inches</i>	mm	<i>inches</i>	mm	<i>inches</i>
H<format>TM1FB<color>-312	Left*	38.10	<i>1.500</i>	22.20	<i>0.875</i>	25.40	<i>1.000</i>	127.00	<i>5.000</i>	7.90	<i>0.312</i>
H<format>TM1FB<color>-438	Left*	38.10	<i>1.500</i>	22.90	<i>0.900</i>	25.40	<i>1.000</i>	127.00	<i>5.000</i>	11.00	<i>0.438</i>
H<format>TM1FB<color>-500	Left*	38.10	<i>1.500</i>	22.20	<i>0.875</i>	25.40	<i>1.000</i>	127.00	<i>5.000</i>	12.70	<i>0.500</i>
H<format>TM1FB<color>-625**	Left*	38.10	<i>1.500</i>	25.40	<i>1.000</i>	50.80	<i>2.000</i>	127.00	<i>5.000</i>	15.90	<i>0.625</i>

\* Hole position is versatile (left or right) on HLTM-FB series tags.  
 Additional sizes and formats available by custom quotation.

**Options**

Package sizes	Standard	550 piece pack	**300 piece pack (HLTM1FB625/HXTM1FB625)
Colors	Standard	White	Yellow
	Code	WE	YW
Format	L	For dot matrix printable	
	X	For thermal transfer printable	

Ordering example: HLTM1FBWE-312

**TP Tape High Performance color-coded cost saving system for tube identification**

The system is designed for use as a thermal transfer printable, self-laminating identification for the various types of tubes in the aerospace, defense and marine industry. Made from polyester with a permanent acrylic adhesive, this cost saving system allows you to print on a unique range of pre color-coded labels on demand and eliminates the use and maintenance of paints, stencils, hot-stamps and etching tools. The system even does the job in a fraction of the time compared to similar technologies.

**Features and benefits**

- Continuous operating temperature of -40°C to +163°C (-40°F to +325°F).
- Resists exposure to water, oil, conventional cleaning agents, oil-based solvents and other fluids commonly associated with commercial and military aircraft.
- Color coded to meet MIL-STD-595B requirements.
- Meets MIL-STD-1247 standards for hydraulic lines, fuel lines, oxygen lines, inerting fluid lines, etc.
- Performance tested to RW 2068, a punishing standard for aggressive fluid and temperature resistance in military and commercial aircraft.
- Available in die-cut or continuous formats to cover all ranges of tube diameters.
- Die-cut version available in white or yellow printable area.
- Continuous version available in white\* or clear printable area.

*\*To be used only with TP-CLEAR-CONT over-laminating product*



**Temperature rating**

Operating temperature range    -40°C to +163°C    -40°F to +325°F

**Specifications/approvals**

Tyco	RW 2068
Military	MIL-T-9906C (except initial peel)
	MIL-STD-595B
	MIL-STD-1247
	MIL-STD-101B

**Printer information**

Tyco printer	T308S* (thermal transfer)
Tyco ribbon	1330-0617-10 (thermal transfer)

*\*Alternative printers and ribbons are available for special applications. Contact Tyco Electronics Identification for more information.*

**Part numbering system**

**TP3 - PNEU - 1.250**

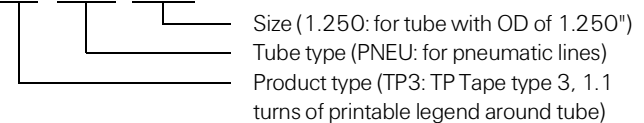

#### Ordering information



#### Available sizes and formats

Order description	Printer type	Label width		Fits tube diameter		Labels per pack
		mm	inches	mm	inches	
TP<format>(XXXX)-0.188	Thermal	63.50	2.500	4.77	0.188	2500
TP<format>(XXXX)-0.250	Thermal	63.50	2.500	6.35	0.250	2000
TP<format>(XXXX)-0.312	Thermal	63.50	2.500	7.92	0.312	2000
TP<format>(XXXX)-0.375	Thermal	63.50	2.500	9.52	0.375	1500
TP<format>(XXXX)-0.500	Thermal	63.50	2.500	12.70	0.500	1500
TP<format>(XXXX)-0.625	Thermal	63.50	2.500	15.88	0.625	1000
TP<format>(XXXX)-0.750	Thermal	63.50	2.500	19.05	0.750	1000
TP<format>(XXXX)-0.875	Thermal	63.50	2.500	22.21	0.875	750
TP<format>(XXXX)-1.000	Thermal	63.50	2.500	25.40	1.000	750
TP<format>(XXXX)-1.125	Thermal	63.50	2.500	28.58	1.125	500
TP<format>(XXXX)-1.250	Thermal	63.50	2.500	31.75	1.250	500
TP<format>(XXXX)-1.375	Thermal	63.50	2.500	34.93	1.375	500
TP<format>(XXXX)-1.500	Thermal	63.50	2.500	38.10	1.500	500
TP<format>(XXXX)-1.625	Thermal	63.50	2.500	41.28	1.625	400
TP<format>(XXXX)-1.750	Thermal	63.50	2.500	44.45	1.750	400
TP<format>(XXXX)-CONT	Thermal	63.50	2.500	50.80+	2.000+	100 ft continuous

#### Options

Format	None	Standard TP Tape
2	For a slit at 2 inches from the left edge (total width 2" /instead of 2.5")	
3	For 1.1 turns of color-coded label around the pipe instead of 1.5 turns	
4	For white printable area instead of yellow	
WE	For white/slit product for European markets, use order description:TP-WE(XXXX)ST-(size)	

#### Identification code (XXXX)

AIRCON	Air conditioning	HYDRO	Hydraulic	PYRO	Pyrotechnic
BATACT	Battery activator	INAIR	Instrument air	RAIN	Rain repellent
COMGAS	Compressed gas	INERT	Inert fluid	RCAT	Rocket catalyst
COOL	Coolant	LUBE	Lubrication	RFUEL	Rocket fuel
DEICE	Deicing fluid	MC	Miscellaneous	ROXI	Rocket oxidizer
ELECT	Electrical conduit	MONO	Mono propellant	SOLV	Solvent
FIRE	Fire protection	OXYGEN	Breathing oxygen	VAC	Vacuum
FUEL	Fuel	PNEU	Pneumatic	WATER	Water injection



**TP Tape (Cont'd) Tube line self-laminating labels for thermal transfer printing**

Colors	Brown	Red	Orange	Yellow	Green
Code	10076	11136	12197	13655	14187

Colors conform to Federal Standard FED-STD-595B

Continuous format TP Tape is supplied with respective legends imprinted, as shown below. Die cut formats are not printed. For example, TP3AIRCON-CONT will have AIR CONDITION printed on each label. TP3AIRCON-O.625 will not.



**TP Tape (Cont'd) Tube line self-laminating labels for thermal transfer printing**

Colors	Blue	Grey	Black	White	Pink	Light Green
Code	15102	16473	17038	17925	21668	24664

Colors conform to Federal Standard FED-STD-595B

Continuous format TP Tape is supplied with respective legends imprinted, as shown below. Die cut formats are not printed. For example, TP3AIRCON-CONT will have AIR CONDITION printed on each label. TP3AIRCON-0.625 will not.



### Printer/material/ribbon compatibility cross reference

Printer	Compatible materials	Standard ribbon
T312M	TMS-SCE	TMS-RJS-RIBBON-4RPSCE
	RPS	TMS-RJS-RIBBON-4RPSCE
	HT-SCE	TMS-RJS-RIBBON-4HT
	ZH-SCE	TMS-RJS-RIBBON-4ZH
	D-SCE	1950-RIBBON-4T300
	HS/HC	1950-RIBBON-4T300
	HX	1950-RIBBON-4T300
	HL	TMS-RJS-RIBBON-4RPSCE
	HLX	1910-RIBBON-4T300
	HXTM-FB	1910-RIBBON-4T300
	HPK	1330-0607-10
	HPKTM	1330-0607-10
	HLTM	1330-0607-10
	TP tape	1330-3300-10
	Polyvinyl fluoride (Tedlar®) (TTVF)	1330-3300-10
	Decals (TTP)	1330-3300-10
	Self-lams (SB/PVF)	1330-3300-10
	Polyimide (Kapton®) (T1K/T2K/TSK)	1330-0619-10
	Nylon cloth (NC)	1330-0607-10
	Polyesters (WP/MP/CP/HW/HM/MV)	1330-0607-10
	Destructible polyethylene (TN)	1330-0607-10
White vinyl (WV)	1330-3300-10	
Paper (EP)	1330-0600-10	
T308S or T312S	Self-lams (SB/PVF)	1330-3300-10
	Polyesters (WP/MP/CP/HW/HM/MV)	1330-0607-10
	Polyimide (Kapton®) (T1K/T2K/TSK)	1330-0619-10
	Polyvinyl fluoride (Tedlar®) (TTVF)	1330-3300-10
	TP tape	1330-3300-10
	HPK	1330-0607-10
	HPKTM	1330-0607-10
	HLTM	1330-0607-10
	Decals (TTP)	1330-3300-10
	Nylon cloth (NC)	1330-0607-10
	Destructible polyethylene (TN)	1330-0607-10
White vinyl (WV)	1330-3300-10	
Paper (EP)	1330-0600-10	
T208M or T212M	TMS-SCE	TMS-101-RIBBON-4RPSCE
	RPS	TMS-101-RIBBON-4RPSCE
	HT-SCE	TMS-101-RIBBON-4HT
	ZH-SCE	T200-RIBBON-4ZH
	D-SCE	TMS-101-RIBBON-4DSCE
	HPK	1330-3300-101TT
	Polyvinyl fluoride (Tedlar®) (TTVF)	1330-3300-101TT
	Decals (TTP)	1330-3300-101TT
	Self-lams (SB/PVF)	1330-3300-101TT
	Nylon cloth (NC)	1330-3300-101TT
	Polyesters (WP/MP/CP/HW/HM/MV)	1330-3300-101TT
	Destructible polyethylene (TN)	1330-3300-101TT
	White vinyl (WV)	1330-3300-101TT
T408M	TMS-SCE	TMS-RJS-RIBBON-4RPSCE
	RPS	TMS-RJS-RIBBON-4RPSCE
	HT-SCE	TMS-RJS-RIBBON-4HT
	ZH-SCE	TMS-RJS-RIBBON-4ZH
	D-SCE	TMS-RJS-RIBBON-4DSCE
	HL	TMS-RJS-RIBBON-4RPSCE
	HLX	1910-RIBBON-4T300

**Printer/material/ribbon compatibility cross reference (Cont'd)**

Printer	Compatible materials	Standard ribbon
T408M (Continued)	HXTM-FB	1910-RIBBON-4T300
	Self-lams (SB/PVF)	1330-3300-10
	Polyesters (WP/MP/CP/HW/HM/MV)	1330-0607-10
	Polyimide (Kapton®) (T1K/T2K/TSK)	1330-0619-10
	Polyvinyl fluoride (Tedlar®) (TTVF)	1330-3300-10
	TP tape	1330-3300-10
	HPK	1330-0607-10
	HPKTM	1330-0607-10
	HLTM	1330-0607-10
	Decals (TTP)	1330-3300-10
	Nylon cloth (NC)	1330-0607-10
	Destructible polyethylene (TN)	1330-0607-10
	White vinyl (WV)	1330-3300-10
	Paper (EP)	1330-0600-10
AM 63 10	TMS-SCE	1892BK04-RIBBON
	RPS	1892BK04-RIBBON
	D-SCE	1892BK04-RIBBON
	CM-SCE	1892BK04-RIBBON
	HS/HC	1892BK04-RIBBON
	HX	1892BK03-HIGH-PERF-RIBBON
	HL	1892BK04-RIBBON
	HM	1892BK04-RIBBON
	NMX	1892BK01
	RMK-6	1892BK04-RIBBON
	HPC	1892BK01
	HLTM	1892BK01
	HPTM	1892BK01
	HLTM-FB	1892BK04-RIBBON
	Polyvinyl fluoride (Tedlar®) (DMVF)	1892BK01
	Self-lams (TW/PV)	1892BK01
	Polyimide (Kapton®) (K)	1892BK01
Vinyl cloth (CW)	1892BK01	
Polyesters (E/M)	1892BK01	
LO870	TMS-SCE	TMS-SYSTEM-SIX-RIBBON-A
	RPS	TMS-SYSTEM-SIX-RIBBON-A
	D-SCE	TMS-SYSTEM-SIX-RIBBON-A
	CM-SCE	TMS-SYSTEM-SIX-RIBBON-A
	NMX	1330-0037-00
	RMK-6	TMS-SYSTEM-SIX-RIBBON-A
	Polyvinyl fluoride (Tedlar®) (DMVF)	1330-0037-00
	Self-lams (TW/PV)	1330-0037-00
	Polyimide (Kapton®) (K)	1330-0037-00
	Vinyl cloth (CW)	1300-0037-00
	Polyesters (E/M)	1330-0037-00
	T612M-DS	TMS-SCE
RPS		TMS-RJS-RIBBON-4RPSCE
ZH-SCE		TMS-RJS-RIBBON-4ZH
HT-SCE		TMS-RJS-RIBBON-4HT
D-SCE		TMS-RJS-RIBBON-4DSCE

**Master materials specification cross reference**

Label ID products

Tyco material	Material	Color	Temperature range		Print technology	Recommended application
			°C	°F		
C	Vinyl cloth	White	-29°C to +80°C	-20°F to +176°F	Dot matrix	Vinyl coated cloth tape with an aggressive adhesive system. For general use in permanent and removable applications. High material strength facilitates easy, clean removal of tape and adhesive. Easy to write on. Excellent resistance to oil, water and humidity. Less than 0.05% UV transmissibility. Clean adhesive removal within one year.
M	Polyester	Silver	-53°C to +93°C	-65°F to +200°F	Dot matrix	Ideal for rating plate applications, graphic symbol identifiers and users who desire a metalized programmable device label. The matte ink receptive coating and Tyco ribbon provide high integrity marking in a variety of environments. Allows less than 0.01% UV transmissibility. UL Listed and CSA Certified.
K	Polyimide (Kapton®)	Tan	-40°C to +260°C	-40°F to +500°F	Dot matrix	Ideal for label requirements on circuit boards. Suitable for direct wave (bottom side) and IR reflow (top side) applications. Polyimide film with unique pressure sensitive adhesive designed to withstand the various fluxes, cleaning solvents and molten solder encountered in the manufacture of printed circuit boards. Flash exposure up to 1000°F.
E	Polyester	White	-53°C to +93°C	-65°F to +200°F	Dot matrix	Ideal for applications requiring exposure to vapor degreaser. The matte ink receptive coating and Tyco ribbon provide high integrity marking in a variety of environments. Allows less than 0.01% UV transmissibility. UL Listed and CSA Certified.
TW	Vinyl	Clear	-54°C to +82°C	-65°F to +180°F	Thermal transfer	An excellent marker for cable, flat ribbon cable, machine tools, tubing or underground wiring. Durable vinyl film with good conformability. Designed to withstand exposure to oil, solvents and water. Supplied with a white print-on or write-on surface for on-the-job marking.
WP	Polyester	White	-40°C to +150°C	-40°F to +302°F	Thermal transfer	Ideal for applications requiring a white high-durability label. Gloss white top-coat offers excellent contrast ratios for barcodes.
CP	Polyester	Clear	-40°C to +150°C	-40°F to +302°F	Call Tyco	Ideal for applications requiring a clear lamination or as a clear label.
HW	Polyester	White	-40°C to +150°C	-40°F to +302°F	Thermal transfer	Ideal for applications that require a high-tack adhesive. White label is excellent for bar code applications. Adhesive is designed to bond to the most demanding surface, including textured and contoured surfaces.
HM	Polyester	Silver	-40°C to +150°C	-40°F to +302°F	Thermal transfer	Ideal for rating plate applications and programmable device labels that require a high-tack adhesive. Adhesive is designed to bond to the most demanding surfaces, including textured and contoured surfaces. UL Listed and CSA Certified.
MP	Polyester	Silver	-40°C to +150°C	-40°F to +302°F	Thermal transfer	Ideal for rating plate applications and users who desire a metalized programmable device label.
MV	Polyester	Silver	-40°C to +150°C	-40°F to +302°F	Thermal transfer	Ideal for rating plate applications and users who desire a label with a silver look and tamper evident feature. Removal after 24 hours results in label fracturing with "VOID" pattern remaining.
TN	Polyethylene	White	-40°C to +80°C	-40°F to +176°F	Thermal transfer	Ideal for applications that require serial numbers, calibration information or other tamper proof identifications. Fractures upon removal after 72 hours.

continued



### Master materials specification cross reference (Cont'd)

Label IDproducts (continued)

Tyco material	Material	Color	Temperature range		Print technology	Recommended application
			°C	°F		
WV	Vinyl	White	-60°C to +95°C	-76°F to +203°F	Thermal transfer	Vinyl film with good conformability to round and flexible surfaces. Excellent for flat ribbon cables that are subjected to repeat bending. Designed to withstand exposure to oil, solvents and water.
NC	Cloth	White	-40°C to +140°C	-40°F to +284°F	Thermal transfer	Excellent for irregular surfaces where conformability is desired. Label will conform to round or flexible surfaces, such as tubing, wiring or cables.
T1K	Polyimide (Kapton®)	White	-40°C to +260°C	-40°F to +500°F	Thermal transfer	Ideal for label requirements on circuit boards. Suitable for direct wave (bottom side) and IR reflow (top side) applications. Designed to withstand the various fluxes, cleaning solvents and molten solder encountered in the manufacture of printed circuit boards. Excellent for bar code applications.
T2K	Polyimide (Kapton®)	White	-40°C to +260°C	-40°F to +500°F	Thermal transfer	Ideal for label requirements on circuit boards. Suitable for direct wave (bottom side) and IR reflow (top side) applications. Designed to withstand the various fluxes, cleaning solvents and molten solder encountered in the manufacture of printed circuit boards. Excellent for auto apply applications.
TSK	Polyimide (Kapton®)	White	-40°C to +260°C	-40°F to +500°F	Thermal transfer	Designed for applications where static charge is critical, such as printed circuit boards and related electronic components. Ideal for high temperature labeling requirements and suitable for direct wave (bottom side) and IR reflow (top side) PCB applications. Withstands the fluxes, cleaning solvents and molten solder encountered in the manufacture of PCBs. Provides excellent contrast for bar code applications.
TAK	Polyimide (Kapton®)	Amber	-40°C to +260°C	-40°F to +500°F	Thermal transfer	Ideal for high temperature labeling requirements such as printed circuit boards. Suitable for direct wave (bottom side) and IR reflow (top side) PCB applications. Designed to withstand the fluxes, cleaning solvents and molten solder encountered in the manufacture of PCBs.
T2Y	Modified polyimide	White	-40°C to +232°C	-40°F to +450°F	Thermal transfer	Ideal for applications requiring a high durability white label that will withstand the temperatures and solvents encountered in printed circuit soldering. Designed as an economic alternative to Tyco's T1K material. Suitable for IR reflow (top side) applications.
KTT	Polyimide (Kapton®)	Tan	-40°C to +260°C	-40°F to +500°F	Thermal transfer	Ideal for high temperature labeling requirements such as printed circuit boards. Suitable for direct wave (bottom side) and IR reflow (top side) PCB applications. Designed to withstand the fluxes, cleaning solvents and molten solder encountered in the manufacture of PCBs.
PVF	Polyvinyl fluoride	White/Yellow	-40°C to +130°C	-40°F to +266°F	Thermal transfer	Excellent for wire and cable marking and other general labeling applications that require the "self-extinguishing" properties of Tedlar®. Ideal for use in a variety of harsh physical and chemical environments. Resists water, oil, cleaning agents and oil based solvents, and filters ultra-violet light.
SB	Vinyl	Clear	-40°C to +80°C	-40°F to +176°F	Thermal transfer	An excellent marker for cable, flat ribbon cable, machine tools, tubing or underground wiring. Durable vinyl film with good conformability. Designed to withstand exposure to oil, solvents and water. Supplied with a white print-on or write-on surface for on-the-job marking.
EP	Paper	White	-54°C to +66°C	-65°F to +200°F	Thermal transfer	Ideal for permanent marking in milder environments when economy is required. The white smooth finish is excellent for bar coding applications. Excellent adhesion to most styrenes, polypropylenes, polyethelenes and paper. Adhesion to corrugation often results in the label or substrate tear when removal is attempted.

**Master materials specification cross reference (Cont'd)**

Tyco material	Material	Color	Temperature range		Print technology	Recommended application
			°C	°F		
LE	Polyester	White	-40°C to +150°C	-40°F to +302°F	Laser	Ideal for general purpose and component labeling. Highly durable image. Ideal for applications requiring a bar code. Top coat designed for use in laser printers.
LM	Polyester	Silver	-40°C to +150°C	-40°F to +302°F	Laser	Excellent for component labeling requiring low UV transmissibility. Metal appearance ideal for rating plate applications. Top coat designed for use in laser printers.

Wire, harness and pipe ID

Tyco material	Material	Color	Temperature range		Recommended application
			°C	°F	
CM-SCE	Radiation cross-linked polyolefin		-55°C to +135°C	-67°F to +275°F	A military grade tag ideal for use in aerospace, defense and commercial applications for large diameter cable bundles or harnesses that go beyond the range of heat-shrink identification sleeves. The product has superior mark permanence and can be attached to the wire bundles using cable ties. The product complements the TMS-SCE and RPS product ranges.
D-SCE	Radiation cross-linked polyolefin		-55°C to +135°C	-67°F to +275°F	A military grade product with superior resistance to several fluids, fuels, cleaning agents and chemicals. The product is ideal for use in harsh-environment applications like rail and mass transit, aerospace, defense and industrial plants for permanent identification of wire and cables. The product covers a broad range of wire diameters for ease of use.
HL	Radiation cross-linked polyolefin		-55°C to +135°C	-67°F to +275°F	A performance grade polyolefin cable tag that comes in various widths and lengths to incorporate several sizes and lines of text and is ideal for use in rail and mass transit and industrial applications. The product complements the HS range of heat-shrink identification sleeves and fills the sizes where a heat-shrink sleeve would be difficult to use.
HS	Radiation cross-linked polyolefin		-55°C to +135°C	-67°F to +275°F	A military grade heat-shrink identification product that comes in several different sleeve lengths and expanded diameters to fit a wide range of wire and cables that require variable text to fit a marker from 0.5in in length to a marker that is 6in in length. The product is ideal for use in the rail and mass transit and industrial applications where endurance to harsh environment and a variety of chemicals is a necessity.
HLTM	Proprint		-54°C to +71°C	-65°F to +160°F	A semi-rigid, heavy gauge Proprint without an adhesive backing. Designed for staple application to plywood control panel backboards for rail signal circuit identification. The standard 1.0" hole pitch design meets AAR terminal post specifications and makes installation fast and convenient. Resistant to common fluids, lubricants and solvents.
HLTM-FB	Polyolefin		-55°C to +135°C	-67°F to +275°F	A semi-rigid, heavy gauge crosslinked polyolefin material without an adhesive backing. Designed for use in a variety of applications including terminal post and terminal board signal circuit identification. The heavy gauge thickness is ideal for applications requiring exceptional durability. Mark permanence exceeds military requirements. Resistant to common fluids, lubricants, solvents and abrasion.
HLX	Radiation cross-linked zero-halogen polyolefin		-30°C to +105°C	-22°F to +221°F	A semi-rigid, heavy gauge specially formulated fabric material with a high tack permanent acrylic adhesive that is designed to permanently identify control panel components and racks, as well as general labeling applications that require a high performance, heavy gauge material. It has excellent abrasion resistance and adheres to most smooth surfaces including bare and painted metal.
HPC	Tyvek®		-54°C to +71°C	-65°F to +160°F	A semi-rigid, heavy gauge Tyvek® designed to permanently identify control panel components and racks, as well as general labeling applications that require a high performance heavy gauge material. Excellent abrasion resistance. Adheres to most smooth surfaces including bare and painted metal.
HPK	Polypropylene		-29°C to +80°C	-24°F to +176°F	A semi-rigid, heavy gauge polypropylene film designed to permanently identify control panel components and racks, as well as general labeling applications that require a high performance heavy gauge material. Excellent abrasion resistance. Adheres to most smooth surfaces including bare and painted metal.
HPKTM	Polypropylene		-29°C to +80°C	-24°F to +176°F	A semi-rigid polypropylene film designed for application to control panel backboards for rail signal circuit identification. The standard 1.0" hole pitch design meets AAR terminal post specifications and makes installation fast and convenient. Adheres to most smooth surfaces including bare and painted metal, as well as painted plywood used for rail signal terminal boards. Resistant to common fluids, lubricants and solvents.
HPTM	Tyvek®		-40°C to +80°C	-40°F to +176°F	A semi-rigid, heavy gauge Tyvek® designed for application in control panel backboards for rail signal circuit identification. The standard 1.0" hole pitch design meets AAR terminal post specifications and makes installation fast and convenient. Adheres to most smooth surfaces including bare and painted metal, as well as painted plywood used for rail signal terminal boards. Resistant to common fluids, lubricants and solvents.

continued

**Master materials specification cross reference (Cont'd)**

Wire, harness and pipe ID (continued)

Tyco material	Material	Temperature range		Recommended application
		°C	°F	
HT-SCE	Radiation cross-linked fluoropolymer	-55°C to +225°C	-67°F to +437°F	A high-temperature resistant permanent identification sleeve system specifically designed for applications requiring exposure to prolonged temperatures and elevated continuous operating temperatures. The product has exceptional resistance to several fluids, solvents, oils and fuels and it's specifically designed low out-gassing properties make it ideal for use around living beings. The product meets several Military specifications and is recommended by NASA as a low-outgassing permanent identification sleeve system. Typical applications include outer space, aerospace and defense.
HTCM-SCE	Radiation cross-linked fluoropolymer	-55°C to +225°C	-67°F to +437°F	A high temperature, low-outgassing tie-on cable tag that complements the HT-SCE identification sleeve product range. Suitable for wire bundles, cables and harnesses that go beyond the size range for the HT-SCE sleeves or require side entry identification, pre or post-termination. The product can be attached using high-temperature resistant cable ties. Recommended on NASA's low-outgassing material list, the product is ideally suited for outer space, aerospace and defense applications.
HX	Radiation cross-linked zero-halogen polyolefin	-30°C to +105°C	-22°F to +221°F	Used to identify wires and cables where low fire hazard properties are critical, the zero halogen material coupled with low smoke and toxic fume emissions make this product ideal for use in enclosed spaces such as mass transit, marine and Industrial installations. The product has exceptional mark permanence to common fluids, solvents and chemicals.
NBC-SCE	Radiation cross-linked fluoropolymer	-55°C to +225°C	-67°F to +437°F	A specially formulated permanent identification sleeve system specifically designed for use in environments exposed to nuclear, biological and chemical agents. The system when used with the appropriate adhesive and oversleeve meets the requirements of an inert system (contact Tyco for details) to identify wire, cables and harnesses. The product has exceptional resistance to several fluids, solvents and fuels. Typical industrial applications include defense harnesses, aerospace, chemical and pharmaceutical plants and infrastructure. The low out-gassing properties make the product exceptionally well-suited for areas that have close contact with humans.
NMX	Polyaramid (Nomex®)	-40°C to +135°C	-40°F to +275°F	A flame retarded polyaramid specially formulated for use in identification of cables and wire bundles as a side entry tag. The tags are attached to the substrate using cable ties. The product is ideal for aerospace and other industries where resistance to harsh environments and weight savings are critical. Available in dot-matrix printable format, the product has exceptional resistance to cleaning fluids, fuels and chemicals commonly associated with the aerospace industry.
RMK	Epoxy coated polyester	-40°C to +105°C	-40°F to +221°F	A specially formulated computer printable label stock designed for applications requiring a permanent mark. When printed using recommended printers and cured using a heat-gun, the unique epoxy on the surface locks the image in place, permanently. Multiple color printing can be done on the label stock at one time. The product provides the benefits of silk-screening, reverse printed membranes and laser engraved signs and switches without the inflexibility associated with these technologies. Typical applications include rating plates, engraved plastic switches and permanent color coding of wires and panels.
RMK-6	Epoxy coated polyester	-40°C to +105°C	-40°F to +221°F	A specially formulated product for use in the harshest of conditions. Available as die-cut labels, the product is inkjet or dot-matrix printable and when cured with a heat gun post printing, the product has a mark that is indelible. Combined with low fire hazard properties, the product is ideal for use where post-burn exposure to living beings is a real risk. Typical applications include rating plates in electronics and components and pipe and cable wrap around marking where permanent mark is desired.
RPS	Radiation cross-linked polyolefin	-30°C to +105°C	-22°F to +221°F	Suitable for applications where permanent identification of wires, cables and harnesses is required and a mil grade material or color coding other than white and yellow is not a necessity. 3:1 shrink ratio, quick-shrink properties and pre-kitted format along with thermal printable characteristics make this product ideal for high-volume applications that are heat-sensitive and withstand harsh environments.
TMS-CCUV	Radiation cross-linked fluoropolymer	-55°C to +150°C	-67°F to +302°F	A transparent heat-shrinkable sleeve that complements the entire heat-shrink and cable tag range of Tyco Identification products. Used in combination with any of the sleeve and tag materials, the product provides exceptional UV and weathering resistance where needed and protects the print from being degraded. The product also works with the NBC-SCE material and used along with an NBC adhesive, conforms to the requirements of an NBC system. The product is available in several different sizes and sleeve lengths. Typical industrial applications include chemical plants, healthcare industry, outer space and nuclear plants. The product is also ideal for NBC harnesses in the defense industry.

continued

## Master materials specification cross reference (Cont'd)

Wire, harness and pipe ID (continued)

Tyco material	Material	Temperature range		Recommended application
		°C	°F	
TMS-SCE	Radiation cross-linked polyolefin	-55°C to +135°C	-67°F to +275°F	A heat-shrink identification product that comes in 2:1 and 3:1 shrink ratios and a large range of diameters to fulfill most of the wire and cable identification needs that demand a permanent marker. The product meets and exceeds the performance requirements of the Mil-23053/5 class 1 and 3 and is suitable for a wide range of industry – from aerospace, defense, rail and mass transit to industrial and electronics sectors. The light weight of the product translates into significant savings for the aerospace industry. The product has quick-shrink properties that make it well-suited for applications that are heat-sensitive. The product also comes in all colors to facilitate color coding while identifying.
TP	Polyester	-40°C to +163°C	-40°F to +375°F	Suitable for tube and pipe labels in the aerospace/defense industry. Several sizes and standard pre-coded patterns for the various types of fluid/air/gas lines eliminate several steps and complex inventories. Flexible material and ultra-aggressive adhesive conform to curved surfaces with ease.
TTP	Polyester	-40°C to +150°C	-40°F to +302°F	The product is an excellent alternative to expensive and in-flexible silk-screen printing. Available in several colors and widths, it is ideal for use as decals requiring excellent resistance to fluids and abrasion and where color printing with variable text is required. Applications include aerospace, defense, rail and mass transit and industrial plants. The product meets print performance requirements of Mil-M-81531.
VF	Polyvinyl fluoride (Tedlar®)	-40°C to +130°C	-40°F to +266°F	A label product ideal for use in color coding and identification of wires, wire bundles and cables. The product can also be used in panels and boards. The product has exceptional resistance to burn and has superior UV stability. Available as continuous and die-cut, the product comes in all standard resistor color codes and meets the requirements of several Military and industry standards for wrapping tapes and labels.
ZH-SCE	Radiation cross-linked zero-halogen polyolefin	-30°C to 105°C	-22°F to +221°F	A halogen-free product suitable for applications where low-smoke upon combustion is a necessity. The product has superior resistance to common fluids and solvents and is ideal for use in rail and mass transit and industrial applications that involve close contact with humans. The product is available for a wide range of wire and cable diameters and shrinks to half the expanded diameter.

### Industry Icon Key



AEROSPACE



AUTOMOTIVE



CIRCUIT BOARDS



COMPONENTS



ELECTRONICS



GENERAL PURPOSE



INDUSTRIAL



MARINE



MEDICAL



MILITARY



RAIL



SPACE



TELECOM

### Part number index

Part number	Page	Part number	Page	Part number	Page	Part number	Page	Part number	Page	Part number	Page
0580	59	A-PV10	51	CP-208086-5-X	68	D-SCE-1K-38-50	23	EP-040040-25-9	94	HL104	137
0581	59	A-TW10	49	CP-222159-15-X	68	D-SCE-1K-4.8-50	23	EP-044033-10-9	94	HL104	137
0615	59	AM6310-230V	111	CP-229064-10-X	68	D-SCE-1K-6.4-50	23	EP-064064-25-9	94	HL104	137
0616	59	AM6310D-110V	111	CP-250381-10-X	68	D-SCE-1K-9.5-50	23	EP-080080-10-9	94	HL104	137
0617	59	AM6310D-230V	111	CP-254045-10-X	68	D1-PV1	51	EP-089047-10-9	94	HL104	137
0618	59	AM6310-110V	111	CP-254064-10-X	68	D1-TW1	49	EP-095080-25-9	94	HL104	137
0620	59	C-064064-10-9	97	CP-254097-10-X	68	D3-PV1	51	EP-095095-10-9	94	HL104	137
0622	59	C-076191-10-9	97	CP-254127-10-X	68	D3-TW1	49	EP-101101-1.3-9	94	HL104	137
0624	59	C-080080-10-9	97	CP-254254-10-9	68	DMVF050	180	EP-101165-0.85-9	94	HL104	137
12510000	59	C-095095-10-9	97	CP-305047-10-X	68	DMVF075	100	EP-101508-2.5-9	94	HL104	137
12520000	59	C-115064-10-9	97	CP-318064-10-X	68	DMVF100	100	EP-101635-2.5-9	94	HL104	137
12530000	59	C-121064-10-9	97	CP-318097-10-X	68	DMVF1029	2.5	EP-101762-1.8-9	94	HL104	137
12540000	59	C-154064-10-9	97	CP-381020-10-X	68	DMVF1079	1	EP-114040-25-9	94	HL104	137
12550000	59	C-159079-10-9	97	CP-381064-10-X	68	DMVF150	100	EP-127032-10-9	94	HL104	137
12560000	59	C-165051-10-9	97	CP-381127-5-X	68	DMVF1529	2.5	EP-127111-10-9	94	HL104	137
1330-0037-00	120	C-191064-10-9	97	CP-381191-5-X	68	DMVF1679	1	EP-127127-10-9	94	HL104	137
1330-0600-10	116	C-203127-10-9	97	CP-381381-2.5-X	68	DMVF200	100	EP-165051-25-9	94	HL104	137
1330-0607-10	115	C-203365-10-9	97	CP-381635-5-X	68	DMVF300	100	EP-165102-10-9	94	HL104	137
1330-0620-10	115	C-215055-10-9	97	CP-406254-1.5-X	68	DMVF3015	1	EP-171171-10-9	94	HL104	137
1330-0621-10	115	C-229064-10-9	97	CP-445064-10-X	68	DMVF3509	2.5	EP-178095-10-9	94	HL104	137
1330-0622-10	115	C-254095-10-9	97	CP-445102-5-X	68	DMVF400	100	EP-191064-10-9	94	HL104	137
1330-0630-10	115	C-254127-10-9	97	CP-445445-2-X	68	DMVF6004	2.5	EP-191114-15-9	94	HL104	137
1330-0631-10	115	C-293064-10-9	97	CP-478175-5-X	68	E-064064-10-9	103	EP-191762-5-9	94	HL104	137
1330-0632-10	115	C-381064-10-S1-9	97	CP-508064-10-X	68	E-076191-10-9	103	EP-203127-10-9	94	HL104	137
1330-3300-10	116	C-394064-10-9	97	CP-508095-5-X	68	E-080080-10-9	103	EP-208086-5-9	94	HL104	137
1330-3300-101TT	117	C-508095-5-9	97	CP-508127-10-X	68	E-095095-10-9	103	EP-222159-15-9	94	HL104	137
1361	56	C-533064-5-9	97	CP-508254-5-X	68	E-102070-10-9	103	EP-229064-10-9	94	HL104	137
11320000	57	C-533114-5-9	97	CP-508318-2.5-X	68	E-115064-10-9	103	EP-250381-10-9	94	HL104	137
11310000	57	C1-PV2.5	51	CP-508508-3-X	68	E-121064-10-9	103	EP-254045-10-9	94	HL104	137
11300000	57	C1-TW2.5	49	CP-523841-1.5-X	68	E-127111-10-9	103	EP-254064-10-9	94	HL104	137
11330000	57	CM-SCE-1/2-4H	7	CP-610419-2.5-X	68	E-127191-10-9	103	EP-254097-10-9	94	HL104	137
1892BK01	121	CM-SCE-1/2-6H	7	CP-699191-5-X	68	E-154064-10-9	103	EP-254127-10-9	94	HL104	137
1892BK03-RIBBON	121	CM-SCE-1/4-4H	7	CP-699254-5-X	68	E-159079-10-9	103	EP-254254-10-9	94	HL104	137
1892BK04-RIBBON	121	CM-SCE-TP-1/4-4H	7	CP-762127-1-X	68	E-165051-10-9	103	EP-305047-10-9	94	HL104	137
1910-RIBBON-4T300	118	CM-SCE-TP-1/2-4H	7	CP-762381-2.5-X	68	E-165101-1-9	103	EP-318064-10-9	94	HL104	137
1950-RIBBON-4T300	119	CM-SCE-TP-1/2-6H	7	CP-762508-2.5-X	68	E-191064-10-9	103	EP-318097-10-9	94	HL104	137
301-LE	105	CP-040040-25-X	68	CR-100-LSR	53	E-203064-10-9	103	EP-381020-10-9	94	HL104	137
301-LM	105	CP-044033-10-X	68	CR-101-LSR	53	E-203127-10-9	103	EP-381064-10-9	94	HL104	137
303-LE	105	CP-064064-25-X	68	CR-105-LSR	53	E-203365-10-9	103	EP-381127-5-9	94	HL104	137
303-LM	105	CP-080080-10-X	68	CR-106-LSR	53	E-215055-10-9	103	EP-381191-5-9	94	HL104	137
304-LE	105	CP-089047-10-X	68	CR-107-LSR	53	E-229064-10-9	103	EP-381381-2.5-9	94	HL104	137
304-LM	105	CP-095080-25-X	68	CR-108-LSR	53	E-254095-10-9	103	EP-381635-5-9	94	HL104	137
305-LE	105	CP-095095-10-X	68	CR-110-LSR	53	E-254127-10-9	103	EP-406254-1.5-9	94	HL104	137
305-LM	105	CP-101101-1.3-X	68	CWM-SL-#	63	E-293064-10-9	103	EP-445064-10-9	94	HL104	137
307-LE	105	CP-101165-0.85-x	68	CWM-SL-letter	63	E-381191-10-9	103	EP-445102-5-9	94	HL104	137
307-LM	105	CP-101508-2.5-X	68	CWM-SL-color	63	E-394064-10-9	103	EP-445445-2-9	94	HL104	137
308-LE	105	CP-101635-2.5-X	68	CWM-SL-legend	63	E-508095-5-9	103	EP-478175-5-9	94	HL104	137
308-LM	105	CP-101762-1.8-X	68	CWM-SQ-1-33	63	E-508254-4-9	103	EP-508064-10-9	94	HL104	137
309-LE	105	CP-114040-25-X	68	CWM-SQ-34-66	63	E-508318-3-9	103	EP-508095-5-9	94	HL104	137
309-LM	105	CP-127032-10-X	68	CWM-SQ-67-99	63	E-533064-5-9	103	EP-508127-10-9	94	HL104	137
310-LE	105	CP-127111-10-X	68	CWM-SQ-A-Z	63	E-533114-5-9	103	EP-508254-5-9	94	HL104	137
310-LM	105	CP-127127-10-X	68	CWM-SQ-AA-ZZ	63	E-572286-2.5-9	103	EP-508318-2.5-9	94	HL104	137
314-LE	105	CP-165051-25-X	68	CWM-SQ-a-z	63	E-673254-3-9	103	EP-508508-3-9	94	HL104	137
314-LM	105	CP-165102-10-X	68	CWM-SQ-1-6	63	E-673349-3-9	103	EP-523841-1.5-9	94	HL104	137
318-LE	105	CP-171171-10-X	68	CWM-SQ-1-18	63	E-699254-2.5-9	103	EP-610419-2.5-9	94	HL104	137
318-LM	105	CP-178095-10-X	68	D-SCE-1K-12-50	23	E-699318-2.5-9	103	EP-699191-5-9	94	HL104	137
319-LE	105	CP-191064-10-X	68	D-SCE-1K-18-50	23	E-711064-5-9	103	EP-699254-5-9	94	HL104	137
319-LM	105	CP-191114-15-X	68	D-SCE-1K-2.4-50	23	E-762508-1-9	103	EP-762127-1-9	94	HL104	137
325-LE	105	CP-191762-5-X	68	D-SCE-1K-25-50	23	E-920254-2.5-9	103	EP-762381-2.5-9	94	HL104	137
325-LM	105	CP-203127-10-X	68	D-SCE-1K-3.2-50	23	E-920381-2.5-9	103	EP-762508-2.5-9	94	HL104	137

### Part number index (Cont'd)

Part number	Page	Part number	Page	Part number	Page	Part number	Page	Part number	Page	Part number	Page
HM-101635-2.5-8A	72	HPKTM1CL-312	34	HW-208086-5-9	70	K-254095-10-1A	101	M-159079-10-8A	99	MP-254254-10-8A	74
HM-101762-1.8-8A	72	HPKTM1CL-438	134	HW-222159-15-9	70	K-254127-10-1A	101	M-165051-10-8A	99	MP-305047-10-8A	74
HM-114040-25-8A	72	HPKTM1CL-500	134	HW-229064-10-9	70	K-293064-10-1A	101	M-165101-1-8A	99	MP-318064-10-8A	74
HM-127032-10-8A	72	HPKTM1CR-312	134	HW-250381-10-9	70	K-508095-5-1A	101	M-191064-10-8A	99	MP-318097-10-8A	74
HM-127111-10-8A	72	HPKTM1CR-438	134	HW-254045-10-9	70	K-533064-5-1A	101	M-203064-10-8A	99	MP-381020-10-8A	74
HM-127127-10-8A	72	HPKTM1CR-500	134	HW-254064-10-9	70	KTT-044033-10-1A	90	M-203127-10-8A	99	MP-381064-10-8A	74
HM-165051-25-8A	72	HPTM1CL-312	132	HW-254097-10-9	70	KTT-064064-25-1A	90	M-203365-10-8A	99	MP-381127-5-8A	74
HM-165102-10-8A	72	HPTM1CL-438	132	HW-254127-10-9	70	KTT-076191-10-1A	90	M-215055-10-8A	99	MP-381191-5-8A	74
HM-171171-10-8A	72	HPTM1CL-500	132	HW-254254-10-9	70	KTT-080080-10-1A	90	M-229064-10-8A	99	MP-381381-2.5-8A	74
HM-178095-10-8A	72	HPTM1CR-312	132	HW-305047-10-9	70	KTT-095080-25-1A	90	M-254095-10-8A	99	MP-381635-5-8A	74
HM-191064-10-8A	72	HPTM1CR-438	132	HW-318064-10-9	70	KTT-095095-10-1A	90	M-254127-10-8A	99	MP-406254-1.5-8A	74
HM-191114-15-8A	72	HPTM1CR-500	132	HW-318097-10-9	70	KTT-127032-10-1A	90	M-293064-10-8A	99	MP-445064-10-8A	74
HM-191762-5-8A	72	HS024-<color...pack size>	9	HW-381020-10-9	70	KTT-127111-10-1A	90	M-381191-10-8A	99	MP-445102-5-8A	74
HM-203127-10-8A	72	HS032-<color...pack size>	9	HW-381064-10-9	70	KTT-127127-10-1A	90	M-394064-10-8A	99	MP-445445-2-8A	74
HM-208086-5-8A	72	HS048-<color...pack size>	9	HW-381127-5-9	70	KTT-165051-25-1A	90	M-508095-5-8A	99	MP-478175-5-8A	74
HM-222159-15-8A	72	HS064-<color...pack size>	9	HW-381191-5-9	70	KTT-171171-10-1A	90	M-508254-4-8A	99	MP-508064-10-8A	74
HM-229064-10-8A	72	HS095-<color...pack size>	9	HW-381381-2.5-9	70	KTT-178095-10-1A	90	M-508318-3-8A	99	MP-508095-5-8A	74
HM-250381-10-8A	72	HS127-<color...pack size>	9	HW-381635-5-9	70	KTT-191064-10-1A	90	M-533064-5-8A	99	MP-508127-10-8A	74
HM-254045-10-8A	72	HS190-<color...pack size>	9	HW-406254-1.5-9	70	KTT-191762-5-1A	90	M-533114-5-8A	99	MP-508254-5-8A	74
HM-254064-10-8A	72	HS254-<color...pack size>	9	HW-445064-10-9	70	KTT-229064-10-1A	90	M-572286-2.5-8A	99	MP-508318-2.5-8A	74
HM-254097-10-8A	72	HS381-<color...pack size>	9	HW-445102-5-9	70	KTT-250381-10-1A	90	M-673254-3-8A	99	MP-508508-3-8A	74
HM-254127-10-8A	72	HT-SCE-1K-1/2-2.0-<c...>	13	HW-445445-2-9	70	KTT-254045-10-1A	90	M-673349-3-8A	99	MP-523841-1.5-8A	74
HM-254254-10-8A	72	HT-SCE-1K-1-2.0-<color>	13	HW-478175-5-9	70	KTT-254064-10-1A	90	M-699254-2.5-8A	99	MP-610419-2.5-8A	74
HM-305047-10-8A	72	HT-SCE-1K-3/8-2.0-<color>	13	HW-508064-10-9	70	KTT-254097-10-1A	90	M-699318-2.5-8A	99	MP-699191-5-8A	74
HM-318064-10-8A	72	HT-SCE-1K-1/2-2.0-<color>	13	HW-508095-5-9	70	KTT-254127-10-1A	90	M-711064-5-8A	99	MP-699254-5-8A	74
HM-318097-10-8A	72	HT-SCE-1K-3/8-2.0-<color>	13	HW-508127-10-9	70	KTT-254254-10-1A	90	M-762508-1-8A	99	MP-762127-1-8A	74
HM-381020-10-8A	72	HT-SCE-1K-3/16-2.0-<color>	13	HW-508254-5-9	70	KTT-305047-10-1A	90	M-920254-2.5-8A	99	MP-762381-2.5-8A	74
HM-381064-10-8A	72	HT-SCE-1K-3/8-2.0-<color>	13	HW-508318-2.5-9	70	KTT-318064-10-1A	90	M-920381-2.5-8A	99	MP-762508-2.5-8A	74
HM-381127-5-8A	72	HT-SCE-1K-1/2-2.0-<color>	13	HW-508508-3-9	70	KTT-381020-10-1A	90	MP-040040-25-8A	74	MV-040040-25-8A	76
HM-381191-5-8A	72	HT-SCE-1K-3/8-2.0-<color>	13	HW-523841-1.5-9	70	KTT-381064-10-1A	90	MP-044033-10-8A	74	MP-044033-10-8A	76
HM-381381-2.5-8A	72	HTCM-SCE-1/4-4H-<color>	15	HW-610419-2.5-9	70	KTT-381127-5-1A	90	MP-064064-25-8A	74	MV-064064-25-8A	76
HM-381635-5-8A	72	HTCM-SCE-1/2-6H-<color>	15	HW-699191-5-9	70	KTT-381381-2.5-1A	90	MP-080080-10-8A	74	MV-080080-10-8A	76
HM-406254-1.5-8A	72	HTCM-SCE-3/4-4H-<color>	15	HW-699254-5-9	70	KTT-381635-5-1A	90	MP-089047-10-8A	74	MV-089047-10-8A	76
HM-445064-10-8A	72	HTCM-SCE-TP-1/4-4H-<c...>	15	HW-762127-1-9	70	KTT-445064-10-1A	90	MP-095080-25-8A	74	MV-095080-25-8A	76
HM-445102-5-8A	72	HTCM-SCE-TP-1/2-4H-<c...>	15	HW-762381-2.5-9	70	KTT-445102-5-1A	90	MP-095095-10-8A	74	MV-095095-10-8A	76
HM-445445-2-8A	72	HTCM-SCE-TP-1/2-6H-<c...>	15	HW-762508-2.5-9	70	KTT-445445-2-1A	90	MP-101101-1-3-8A	74	MP-101101-1-3-8A	76
HM-478175-5-8A	72	HW-040040-25-9	70	HX-032-<color...pack size>	18	KTT-508064-10-1A	90	MP-101165-0.85-8A	74	MV-101165-0.85-8A	76
HM-508064-10-8A	72	HW-044033-10-9	70	HX-048-<color...pack size>	18	KTT-508095-5-1A	90	MP-101508-2.5-8A	74	MV-101508-2.5-8A	76
HM-508095-5-8A	72	HW-064064-25-9	70	HX-064-<color...pack size>	18	KTT-508127-10-1A	90	MP-101635-2.5-8A	74	MV-101635-2.5-8A	76
HM-508127-10-8A	72	HW-080080-10-9	70	HX-095-<color...pack size>	18	KTT-508508-3-1A	90	MP-101762-1.8-8A	74	MV-101762-1.8-8A	76
HM-508254-5-8A	72	HW-089047-10-9	70	HX-127-<color...pack size>	18	KTT-523841-1.5-1A	90	MP-114040-25-8A	74	MV-114040-25-8A	76
HM-508318-2.5-8A	72	HW-095080-25-9	70	HX-190-<color...pack size>	18	LEB2-0615P	105	MP-127032-10-8A	74	MP-127032-10-8A	76
HM-508508-3-8A	72	HW-095095-10-9	70	HX-254-<color...pack size>	18	LEB2-0818P	105	MP-127111-10-8A	74	MV-127111-10-8A	76
HM-523841-1.5-8A	72	HW-101101-1.3-9	70	HX-381-<color...size>	18	LEB2-0820P	105	MP-127127-10-8A	74	MV-127127-10-8A	76
HM-610419-2.5-8A	72	HW-101165-0.85-9	70	J-PV10	51	LEB2-0825P	105	MP-165051-25-8A	74	MV-165051-25-8A	76
HM-699191-5-8A	72	HW-101508-2.5-9	70	J-TW10	49	LEB2-0916P	105	MP-165102-10-8A	74	MV-165102-10-8A	76
HM-699254-5-8A	72	HW-101635-2.5-9	70	K-064064-10-1A	101	LEB2-0920P	105	MP-171171-10-8A	74	MV-171171-10-8A	76
HM-762127-1-8A	72	HW-101762-1.8-9	70	K-076191-10-1A	101	LEB2-1318P	105	MP-178095-10-8A	74	MV-178095-10-8A	76
HM-762381-2.5-8A	72	HW-114040-25-9	70	K-080080-10-1A	101	LEB2-1325P	105	MP-191064-10-8A	74	MV-191064-10-8A	76
HM-762508-2.5-8A	72	HW-127032-10-9	70	K-095095-10-1A	101	LMS-9000	113	MP-191114-15-8A	74	MV-191114-15-8A	76
HPC02WE1050	43	HW-127111-10-9	70	K-115064-10-1A	101	M-064064-10-8A	99	MP-191762-5-8A	74	MV-191762-5-8A	76
HPC04WE1050	43	HW-127127-10-9	70	K-121064-10-1A	101	M-076191-10-8A	99	MP-203127-10-8A	74	MV-203127-10-8A	76
HPC06WE1050	43	HW-165051-25-9	70	K-154064-10-1A	101	M-080080-10-8A	99	MP-208086-5-8A	74	MV-208086-5-8A	76
HPC08WE1050	43	HW-165102-10-9	70	K-159079-10-1A	101	M-095095-10-8A	99	MP-222159-15-8A	74	MV-222159-15-8A	76
HPC10WE1050	43	HW-171171-10-9	70	K-165051-10-1A	101	M-102070-10-8A	99	MP-229064-10-8A	74	MV-229064-10-8A	76
HPK02WE1050	41	HW-178095-10-9	70	K-191064-10-1A	101	M-115064-10-8A	99	MP-250381-10-8A	74	MV-250381-10-8A	76
HPK04WE1050	41	HW-191064-10-9	70	K-203127-10-1A	101	M-121064-10-8A	99	MP-254045-10-8A	74	MV-254045-10-8A	76
HPK06WE1050	41	HW-191114-15-9	70	K-203365-10-1A	101	M-127111-10-8A	99	MP-254064-10-8A	74	MV-254064-10-8A	76
HPK08WE1050	41	HW-191762-5-9	70	K-215055-10-1A	101	M-127191-10-8A	99	MP-254097-10-8A	74	MV-254097-10-8A	76
HPK10WE1050	41	HW-203127-10-9	70	K-229064-10-1A	101	M-154064-10-8A	99	MP-254127-10-8A	74	MV-254127-10-8A	76

### Part number index (Cont'd)

Part number	Page	Part number	Page	Part number	Page	Part number	Page	Part number	Page	Part number	Page
MV-254254-10-8A	76	NC-381064-10-S1-9	82	PVF-254254-10-9	92	RMK-50x13-A4	37	T-TW2.5	49	T2K-254127-10-9	86
MV-305047-10-8A	76	NC-381127-5-9	82	PVF-305047-10-9	92	RMK-50x25-A4	37	T1K-044033-10-9	84	T2K-254254-10-9	86
MV-318064-10-8A	76	NC-381381-2.5-9	82	PVF-318064-10-9	92	RMK-50x100-A4	37	T1K-064064-25-9	84	T2K-305047-10-9	86
MV-318097-10-8A	76	NC-381635-5-9	82	PVF-318097-10-9	92	RMK-75-150-A4	37	T1K-076191-10-9	84	T2K-318064-10-9	86
MV-381020-10-8A	76	NC-445064-10-9	82	PVF-381020-10-9	92	RMK-87x13-A4	37	T1K-080080-10-9	84	T2K-381020-10-9	86
MV-381064-10-8A	76	NC-445102-5-9	82	PVF-381064-10-9	92	RMK-87x25-A4	37	T1K-095080-25-9	84	T2K-381064-10-9	86
MV-381127-5-8A	76	NC-445445-2-9	82	PVF-381127-5-9	92	RMK-150x150-A4	37	T1K-095095-10-9	84	T2K-381127-5-9	86
MV-381191-5-8A	76	NC-508064-10-9	82	PVF-381191-5-9	92	RMK-170x13-A4	37	T1K-127032-10-9	84	T2K-381381-2.5-9	86
MV-381381-2.5-8A	76	NC-508095-5-9	82	PVF-381381-2.5-9	92	RMK-170x25-A4	37	T1K-127111-10-9	84	T2K-381635-5-9	86
MV-381635-5-8A	76	NC-508127-10-9	82	PVF-381635-5-9	92	RMK-190x30-A4	37	T1K-127127-10-9	84	T2K-445064-10-9	86
MV-406254-1.5-8A	76	NC-508508-3-9	82	PVF-406254-1.5-9	92	RMK-200x13-A4	37	T1K-165051-25-9	84	T2K-445102-5-9	86
MV-445064-10-8A	76	NC-523841-1.5-9	82	PVF-445064-10-9	92	RMK-250x13-A4	37	T1K-171171-10-9	84	T2K-445445-2-9	86
MV-445102-5-8A	76	NMX25625<color>2.5	25	PVF-445102-5-9	92	RMK-250x25-A4	37	T1K-178095-10-9	84	T2K-508064-10-9	86
MV-445445-2-8A	76	NPVF050XX-100	33	PVF-445445-2-9	92	RMK-9x25.A4	37	T1K-191064-10-9	84	T2K-508095-5-9	86
MV-478175-5-8A	76	NPVF150CL-100	33	PVF-478175-5-9	92	RMK-UNCUT-44	37	T1K-191762-5-9	84	T2K-508127-10-9	86
MV-508064-10-8A	76	NPVF200CL-100	33	PVF-508064-10-9	92	RMK6-12.7	34	T1K-229064-10-9	84	T2K-508508-3-9	86
MV-508095-5-8A	76	NPVF300CL-100	33	PVF-508095-5-9	92	RMK6-17.0	34	T1K-250381-10-9	84	T2K-523841-1.5-9	86
MV-508127-10-8A	76	NPVF400CL-100	33	PVF-508127-10-9	92	RMK6-25.4	34	T1K-254045-10-9	84	T2K-523841-3-9	86
MV-508254-5-8A	76	O-PV10	51	PVF-508254-5-9	92	RMK6-4.2	34	T1K-254064-10-9	84	T2Y-064064-25-9	89
MV-508318-2.5-8A	76	O-TW10	49	PVF-508318-2.5-9	92	RMK6-55.0	34	T1K-254097-10-9	84	T2Y-076191-10-9	89
MV-508508-3-8A	76	P-PV5	51	PVF-508508-3-9	92	RMK6-8.5	34	T1K-254127-10-9	84	T2Y-080080-10-9	89
MV-523841-1.5-8A	76	P-TW5	49	PVF-523841-1.5-9	92	RMK6-WM	34	T1K-254254-10-9	84	T2Y-095080-25-9	89
MV-610419-2.5-8A	76	PM07507-1-<font>	131	PVF-610419-2.5-9	92	RPS-1K-1-400/2.0<color>	26	T1K-305047-10-9	84	T2Y-095095-10-9	89
MV-699191-5-8A	76	PM09512-<lines>	131	PVF-699191-5-9	92	RPS-1K-10-2/2.0<color>	26	T1K-318064-10-9	84	T2Y-127032-10-9	89
MV-699254-5-8A	76	Pre-Print	129	PVF-699254-5-9	92	RPS-1K-16-10/2.0<color>	26	T1K-381020-10-9	84	T2Y-127111-10-9	89
MV-762127-1-8A	76	PRINT-EASY-PRO	125	PVF-762127-1-9	92	RPS-1K-18-12/2.0<color>	26	T1K-381064-10-9	84	T2Y-127127-10-9	89
MV-762381-2.5-8A	76	PRINT-EASY-SUITE	125	PVF-762381-2.5-9	92	RPS-1K-22-18/2.0<color>	26	T1K-381127-5-9	84	T2Y-165051-25-9	89
MV-762508-2.5-8A	76	PRINT-EASY-NET05	125	PVF-762508-2.5-9	92	RPS-1K-400-1000/2.0<c...>	26	T1K-381381-2.5-9	84	T2Y-171171-10-9	89
N-PV10	51	PVF-040040-25-9	92	PVF050100WE10	46	RPS-1K-6-250/2.0<color>	26	T1K-381635-5-9	84	T2Y-178095-10-9	89
N-TW10	49	PVF-044033-10-9	92	PVF050143WE10	46	RPS-1K-8-4/2.0<color>	26	T1K-445064-10-9	84	T2Y-191064-10-9	89
NBC-SCE-1K-1½-2.0<c...>	28	PVF-064064-25-9	92	PVF080150WE10	46	S-PV2.5	51	T1K-445102-5-9	84	T2Y-191762-5-9	89
NBC-SCE-1K-1-2.0<c...>	28	PVF-080080-10-9	92	PVF100143WE5	46	S-TW2.5	49	T1K-445445-2-9	84	T2Y-229064-10-9	89
NBC-SCE-1K-½-2.0<c...>	28	PVF-089047-10-9	92	PVF100225WE5	46	SB050100WE10	44	T1K-508064-10-9	84	T2Y-250381-10-9	89
NBC-SCE-1K-¼-2.0<c...>	28	PVF-095080-25-9	92	PVF100375WE2.5	46	SB050143WE10	44	T1K-508095-5-9	84	T2Y-254045-10-9	89
NBC-SCE-1K-¼-2.0<c...>	28	PVF-095095-10-9	92	PVF100594WE1	46	SB075094WE10	44	T1K-508127-10-9	84	T2Y-254064-10-9	89
NBC-SCE-1K-¼-2.0<c...>	28	PVF-101101-1.3-9	92	PVF100743WE1	46	SB080150WE10	44	T1K-508508-3-9	84	T2Y-254097-10-9	89
NC-044033-10-9	82	PVF-101165-0.85-9	92	PVF190319WE2.5	46	SB100143WE5	44	T1K-523841-1.5-9	84	T2Y-254127-10-9	89
NC-064064-25-9	82	PVF-101508-2.5-9	92	PVF190594WE1	46	SB100225WE5	44	T208M-PRINTER	107	T2Y-254254-10-9	89
NC-076191-10-9	82	PVF-101635-2.5-9	92	PVF200143WE2.5	46	SB100375WE2.5	44	T208M-C-PRINTER	107	T2Y-305047-10-9	89
NC-080080-10-9	82	PVF-101762-1.8-9	92	PVF200225WE2.5	46	SB100594WE1	44	T212M-PRINTER	107	T2Y-318064-10-9	89
NC-095080-25-9	82	PVF-114040-25-9	92	PVF200375WE2.5	46	SB100743WE1	44	T212M-C-PRINTER	107	T2Y-381020-10-9	89
NC-095095-10-9	82	PVF-127032-10-9	92	PVF200743WE1	46	SB190319WE2.5	44	T2K-044033-10-9	86	T2Y-381064-10-9	89
NC-127032-10-9	82	PVF-127111-10-9	92	Q-PV10	51	SB190594WE1	44	T2K-064064-25-9	86	T2Y-381127-5-9	89
NC-127111-10-9	82	PVF-127127-10-9	92	Q-TW10	49	SB200143WE2.5	44	T2K-076191-10-9	86	T2Y-381381-2.5-9	89
NC-127127-10-9	82	PVF-165051-25-9	92	R-PV5	51	SB200225WE2.5	44	T2K-080080-10-9	86	T2Y-381635-5-9	89
NC-165051-25-9	82	PVF-165102-10-9	92	R-TW5	49	SB200375WE2.5	44	T2K-095080-25-9	86	T2Y-445064-10-9	89
NC-178095-10-9	82	PVF-171171-10-9	92	RMK-10x19-A4	37	SB200743WE1	44	T2K-095095-10-9	86	T2Y-445102-5-9	89
NC-191064-10-9	82	PVF-178095-10-9	92	RMK-11x40-A4	37	SBH100375WE2.5	44	T2K-127032-10-9	86	T2Y-445445-2-9	89
NC-191762-5-9	82	PVF-191064-10-9	92	RMK-18x20-A4	37	STD01	61	T2K-127111-10-9	86	T2Y-508064-10-9	89
NC-229064-10-9	82	PVF-191114-15-9	92	RMK-18x25-A4	37	STD02	61	T2K-127127-10-9	86	T2Y-508095-5-9	89
NC-250381-10-9	82	PVF-191762-5-9	92	RMK-18x35-A4	37	STD03	61	T2K-165051-25-9	86	T2Y-508127-10-9	89
NC-254045-10-9	82	PVF-203127-10-9	92	RMK-18x50-A4	37	STD06	61	T2K-171171-10-9	86	T2Y-508508-3-9	89
NC-254064-10-9	82	PVF-208086-5-9	92	RMK-25x30-A4	37	STD08	61	T2K-178095-10-9	86	T2Y-523841-1.5-9	89
NC-254097-10-9	82	PVF-222159-15-9	92	RMK-25x35-A4	37	STD12	61	T2K-191064-10-9	86	T200-RIBBON-WH-4HT	115
NC-254127-10-9	82	PVF-229064-10-9	92	RMK-25x100-A4	37	STD15	61	T2K-191762-5-9	86	T200-RIBBON-4ZH	119
NC-254254-10-9	82	PVF-250381-10-9	92	RMK-25x50-A4	37	STD15	61	T2K-229064-10-9	86	T300-RIBBON-WH	114
NC-305047-10-9	82	PVF-254045-10-9	92	RMK-25x75-A4	37	STD17	61	T2K-250381-10-9	86	T300-RIBBON-WH-4HT	114
NC-318064-10-9	82	PVF-254064-10-9	92	RMK-28x40-A4	37	STD21	61	T2K-254045-10-9	86	T308S-PRINTER	108
NC-381020-10-9	82	PVF-254097-10-9	92	RMK-30x13-A4	37	STD24	61	T2K-254064-10-9	86	T308S-N-PRINTER	108
NC-381064-10-9	82	PVF-254127-10-9	92	RMK-35x75-A4	37	T-PV2.5	51	T2K-254097-10-9	86	T308S-C-PRINTER	108

**Part number index (Cont'd)**

Part number	Page	Part number	Page	Part number	Page	Part number	Page	Part number	Page	Part number	Page
T308S-R-PRINTER	108	TMS-CCUV-SLEEVE-3-...	30	TN-254045-10-9	78	TSK-191064-10-9	88	WP-114040-25-9	66	WW-127032-10-9	80
T312M-PRINTER	108	TMS-CCUV-SLEEVE-4-...	30	TN-254064-10-9	78	TSK-191762-5-9	88	WP-127032-10-9	66	WW-127111-10-9	80
T312M-R-PRINTER	108	TMS-CCUV-SLEEVE-5-...	30	TN-254097-10-9	78	TSK-229064-10-9	88	WP-127111-10-9	66	WW-127127-10-9	80
T312S-PRINTER	108	TMS-CCUV-SLEEVE-6-...	30	TN-254127-10-9	78	TSK-250381-10-9	88	WP-127127-10-9	66	WW-165051-25-9	80
T312S-C-PRINTER	108	TMS-CCUV-SLEEVE-7-...	30	TN-254254-10-9	78	TSK-254045-10-9	88	WP-165051-25-9	66	WW-165102-10-9	80
T312S-R-PRINTER	108	TMS-CCUV-SLEEVE-8-...	30	TN-305047-10-9	78	TSK-254064-10-9	88	WP-165102-10-9	66	WW-171171-10-9	80
T408M-PRINTER	109	TMS-CCUV-SLEEVE-9-...	30	TN-318064-10-9	78	TSK-254097-10-9	88	WP-171171-10-9	66	WW-178095-10-9	80
T408M-R-PRINTER	109	TMS-101-RIB...-WH-SCE	118	TN-318097-10-9	78	TSK-254127-10-9	88	WP-178095-10-9	66	WW-191064-10-9	80
T612M-DS-PRINTER	110	TMS-RJS-RIBBON-4HT	117	TN-381020-10-9	78	TSK-254254-10-9	88	WP-191064-10-9	66	WW-191114-15-9	80
TAK-044033-10-3A	87	TMS-RJS-R...-4RPSCE	117	TN-381064-10-9	78	TSK-305047-10-9	88	WP-191114-15-9	66	WW-191762-5-9	80
TAK-064064-25-3A	87	TMS-RJS-RIBBON-4ZH	118	TN-381127-5-9	78	TSK-318064-10-9	88	WP-191762-5-9	66	WW-203127-10-9	80
TAK-076191-10-3A	87	TMS-SCE-1K-1½-2.0-<c...>	4	TN-381191-5-9	78	TSK-381020-10-9	88	WP-203127-10-9	66	WW-208086-5-9	80
TAK-080080-10-3A	87	TMS-SCE-1K-1-2.0-<c...>	4	TN-381381-2.5-9	78	TSK-381064-10-9	88	WP-208086-5-9	66	WW-222159-15-9	80
TAK-095080-25-3A	87	TMS-SCE-1K-½-2.0-<c...>	4	TN-381635-5-9	78	TSK-381127-5-9	88	WP-222159-15-9	66	WW-229064-10-9	80
TAK-095095-10-3A	87	TMS-SCE-1K-¾-2.0-<c...>	4	TN-406254-1.5-9	78	TSK-381381-2.5-9	88	WP-229064-10-9	66	WW-250381-10-9	80
TAK-127032-10-3A	87	TMS-SCE-1K-¾-2.0-<c...>	4	TN-445064-10-9	78	TSK-381635-5-9	88	WP-250381-10-9	66	WW-254045-10-9	80
TAK-127111-10-3A	87	TMS-SCE-1K-2½-2.0-<c...>	4	TN-445102-5-9	78	TSK-445064-10-9	88	WP-254045-10-9	66	WW-254064-10-9	80
TAK-127127-10-3A	87	TMS-SCE-1K-2-2.0-<c...>	4	TN-445445-2-9	78	TSK-445102-5-9	88	WP-254064-10-9	66	WW-254097-10-9	80
TAK-165051-25-3A	87	TMS-SCE-1K-¾-2.0-<c...>	4	TN-478175-5-9	78	TSK-445445-2-9	88	WP-254097-10-9	66	WW-254127-10-9	80
TAK-171171-10-3A	87	TMS-SCE-1K-¾-2.0-<c...>	4	TN-508064-10-9	78	TSK-508064-10-9	88	WP-254127-10-9	66	WW-254254-10-9	80
TAK-178095-10-3A	87	TMS-SCE-1K-¾-2.0-<c...>	4	TN-508095-5-9	78	TSK-508095-5-9	88	WP-254254-10-9	66	WW-305047-10-9	80
TAK-191064-10-3A	87	TMS-SCE-1K-¾-2.0-<c...>	4	TN-508127-10-9	78	TSK-508127-10-9	88	WP-305047-10-9	66	WW-318064-10-9	80
TAK-191762-5-3A	87	TMS-SCE-2X-1K-½-2.0-<c...>	4	TN-508254-5-9	78	TSK-508508-3-9	88	WP-318064-10-9	66	WW-318097-10-9	80
TAK-229064-10-3A	87	TMS-SCE-2X-1K-¾-2.0-<c...>	4	TN-508318-2.5-9	78	TSK-523841-1.5-9	88	WP-318097-10-9	66	WW-381020-10-9	80
TAK-250381-10-3A	87	TMS-SCE-2X-1K-¾-2.0-<c...>	4	TN-508508-3-9	78	TTP200<color>-10	38	WP-381020-10-9	66	WW-381064-10-9	80
TAK-254045-10-3A	87	TMS-SCE-2X-1K-¾-2.0-<c...>	4	TN-523841-1.5-9	78	TTP300<color>-10	38	WP-381064-10-9	66	WW-381127-5-9	80
TAK-254064-10-3A	87	TMS-SCE-2X-1K-¾-2.0-<c...>	4	TN-610419-2.5-9	78	TTP400<color>-10	38	WP-381127-5-9	66	WW-381191-5-9	80
TAK-254097-10-3A	87	TMS-SCE-2X-1K-¾-2.0-<c...>	4	TN-699191-5-9	78	TTP600<color>-10	38	WP-381191-5-9	66	WW-381381-2.5-9	80
TAK-254127-10-3A	87	TMS-SCE-2X-1K-¾-2.0-<c...>	4	TN-699254-5-9	78	TTVF050<color>-180	32	WP-381381-2.5-9	66	WW-445064-10-9	80
TAK-254254-10-3A	87	TMS-SIX-PRXM-PR1...	112	TN-762127-1-9	78	TTVF075<color>-100	32	WP-381635-5-9	66	WW-445102-5-9	80
TAK-305047-10-3A	87	TMS-SYSTEM-SIX-R...	120	TN-762381-2.5-9	78	TTVF100<color>-100	32	P-406254-1.5-9	66	WW-445445-2-9	80
TAK-318064-10-3A	87	TMS-WINTOTAL-SW...	122	TN-762508-2.5-9	78	TTVF1029<color>-2.5	32	WP-445064-10-9	66	WW-478175-5-9	80
TAK-381020-10-3A	87	TN-040040-25-9	78	TP<f...>(XXXX)-0.188	138	TTVF1079<color>-1	32	WP-445102-5-9	66	WW-508064-10-9	80
TAK-381064-10-3A	87	TN-044033-10-9	78	TP<f...>(XXXX)-0.250	138	TTVF150<color>-100	32	WP-445445-2-9	66	WW-508095-5-9	80
TAK-381127-5-3A	87	TN-064064-25-9	78	TP<f...>(XXXX)-0.312	138	TTVF1529<color>-2.5	32	WP-478175-5-9	66	WW-508127-10-9	80
TAK-381381-2.5-3A	87	TN-080080-10-9	78	TP<f...>(XXXX)-0.375	138	TTVF1679<color>-1	32	WP-508064-10-9	66	WW-508254-5-9	80
TAK-381635-5-3A	87	TN-089047-10-9	78	TP<f...>(XXXX)-0.500	138	TTVF200<color>-100	32	WP-508095-5-9	66	WW-508318-2.5-9	80
TAK-445064-10-3A	87	TN-095080-25-9	78	TP<f...>(XXXX)-0.625	138	TTVF300<color>-100	32	WP-508127-10-9	66	WW-508508-3-9	80
TAK-445102-5-3A	87	TN-095095-10-9	78	TP<f...>(XXXX)-0.750	138	TTVF3015<color>-1	32	WP-508254-5-9	66	WW-523841-1.5-9	80
TAK-445445-2-3A	87	TN-101101-1.3-9	78	TP<f...>(XXXX)-0.875	138	TTVF3509<color>-2.5	32	WP-508318-2.5-9	66	WW-610419-2.5-9	80
TAK-508064-10-3A	87	TN-101165-0.85-9	78	TP<f...>(XXXX)-1.000	138	TTVF400<color>-100	32	WP-508508-3-9	66	WW-699191-5-9	80
TAK-508095-5-3A	87	TN-101508-2.5-9	78	TP<f...>(XXXX)-1.125	138	TTVF6004<color>-2.5	32	WP-523841-1.5-9	66	WW-699254-5-9	80
TAK-508127-10-3A	87	TN-101635-2.5-9	78	TP<f...>(XXXX)-1.250	138	U-PV2.5	51	WP-610419-2.5-9	66	WW-762127-1-9	80
TAK-508508-3-3A	87	TN-101762-1.8-9	78	TP<f...>(XXXX)-1.375	138	U-TW2.5	49	WP-699191-5-9	66	WW-762381-2.5-9	80
TAK-523841-1.5-3A	87	TN-114040-25-9	78	TP<f...>(XXXX)-1.500	138	W1-PV1	51	WP-699254-5-9	66	WW-762508-2.5-9	80
TMS-101-RIBBON-4HT	118	TN-127032-10-9	78	TP<f...>(XXXX)-1.625	138	W1-TW1	49	WP-762127-1-9	66	ZH-SCE-1K-1½-2.0-<c...>	16
TMS-101-R...-4RPSCE	117	TN-127111-10-9	78	TP<f...>(XXXX)-1.750	138	W2-PV1	51	WP-762381-2.5-9	66	ZH-SCE-1K-1-2.0-<color>	16
TMS-101-RIBBON-4ZH	118	TN-127127-10-9	78	TP<f...>(XXXX)-CONT	138	W2-TW1	49	WP-762508-2.5-9	66	WP-762508-2.5-9	66
TMS-743-EP-LQ870-P...	110	TN-165051-25-9	78	TSK-044033-10-9	88	WP-040040-25-9	66	WW-040040-25-9	80	ZH-SCE-1K-¾-2.0-<color>	16
TMS-CCUV-SLEEVE-1-...	30	TN-165102-10-9	78	TSK-064064-25-9	88	WP-044033-10-9	66	WW-044033-10-9	80	ZH-SCE-1K-¾-2.0-<color>	16
TMS-CCUV-SLEEVE-10-...	30	TN-171171-10-9	78	TSK-076191-10-9	88	WP-064064-25-9	66	WW-080080-10-9	80	ZH-SCE-1K-¾-2.0-<color>	16
TMS-CCUV-SLEEVE-15	30	TN-178095-10-9	78	TSK-080080-10-9	88	WP-080080-10-9	66	WW-089047-10-9	80	ZH-SCE-1K-¾-2.0-<color>	16
TMS-CCUV-SLEEVE-16	30	TN-191064-10-9	78	TSK-095080-25-9	88	WP-089047-10-9	66	WW-095080-25-9	80	ZH-SCE-1K-¾-2.0-<color>	16
TMS-CCUV-SLEEVE-17	30	TN-191114-15-9	78	TSK-095095-10-9	88	WP-095080-25-9	66	WW-095095-10-9	80	ZH-SCE-1K-¾-2.0-<color>	16
TMS-CCUV-SLEEVE-18	30	TN-191762-5-9	78	TSK-127032-10-9	88	WP-095095-10-9	66	WW-101101-1.3-9	80		
TMS-CCUV-SLEEVE-19	30	TN-203127-10-9	78	TSK-127111-10-9	88	WP-101101-1.3-9	66	WW-101165-0.85-9	80		
TMS-CCUV-SLEEVE-2-...	30	TN-208086-5-9	78	TSK-127127-10-9	88	WP-101165-0.85-9	66	WW-101508-2.5-9	80		
TMS-CCUV-SLEEVE-20	30	TN-222159-15-9	78	TSK-165051-25-9	88	WP-101508-2.5-9	66	WW-101635-2.5-9	80		
TMS-CCUV-SLEEVE-21	30	TN-229064-10-9	78	TSK-171171-10-9	88	WP-101635-2.5-9	66	WW-101762-1.8-9	80		
TMS-CCUV-SLEEVE-22	30	TN-250381-10-9	78	TSK-178095-10-9	88	WP-101762-1.8-9	66	WW-114040-25-9	80		





Компания «ЭлектроПласт» предлагает заключение долгосрочных отношений при поставках импортных электронных компонентов на взаимовыгодных условиях!

Наши преимущества:

- Оперативные поставки широкого спектра электронных компонентов отечественного и импортного производства напрямую от производителей и с крупнейших мировых складов;
- Поставка более 17-ти миллионов наименований электронных компонентов;
- Поставка сложных, дефицитных, либо снятых с производства позиций;
- Оперативные сроки поставки под заказ (от 5 рабочих дней);
- Экспресс доставка в любую точку России;
- Техническая поддержка проекта, помощь в подборе аналогов, поставка прототипов;
- Система менеджмента качества сертифицирована по Международному стандарту ISO 9001;
- Лицензия ФСБ на осуществление работ с использованием сведений, составляющих государственную тайну;
- Поставка специализированных компонентов (Xilinx, Altera, Analog Devices, Intersil, Interpoint, Microsemi, Aeroflex, Peregrine, Syfer, Eurofarad, Texas Instrument, Miteq, Cobham, E2V, MA-COM, Hittite, Mini-Circuits, General Dynamics и др.);

Помимо этого, одним из направлений компании «ЭлектроПласт» является направление «Источники питания». Мы предлагаем Вам помощь Конструкторского отдела:

- Подбор оптимального решения, техническое обоснование при выборе компонента;
- Подбор аналогов;
- Консультации по применению компонента;
- Поставка образцов и прототипов;
- Техническая поддержка проекта;
- Защита от снятия компонента с производства.



#### Как с нами связаться

**Телефон:** 8 (812) 309 58 32 (многоканальный)

**Факс:** 8 (812) 320-02-42

**Электронная почта:** [org@eplast1.ru](mailto:org@eplast1.ru)

**Адрес:** 198099, г. Санкт-Петербург, ул. Калинина, дом 2, корпус 4, литера А.