



C2M1000170J

Silicon Carbide Power MOSFET
C2M™ MOSFET Technology
 N-Channel Enhancement Mode

V_{DS}	1700 V
$I_D @ 25^\circ\text{C}$	5.3 A
$R_{DS(on)}$	1.0 Ω

Features

- High blocking voltage with low $R_{DS(on)}$
- Easy to parallel and simple to drive
- Low parasitic inductance
- Separate driver source pin
- Ultra-low drain-gate capacitance
- Halogen Free, RoHS compliant

Benefits

- Higher system efficiency
- Smooth switching waveforms
- Reduced cooling requirements
- Increased system reliability

Applications

- Auxiliary power supplies
- Switch Mode Power Supplies
- High-voltage capacitive loads

Package

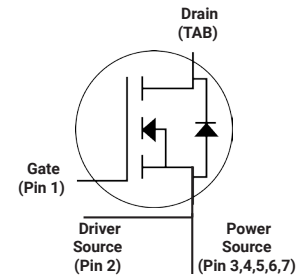

Part Number	Package
C2M1000170J	7L D2PAK

Maximum Ratings ($T_C = 25^\circ\text{C}$ unless otherwise specified)

Symbol	Parameter	Value	Unit	Test Conditions	Note
V_{DSmax}	Drain - Source Voltage	1700	V	$V_{GS} = 0\text{ V}, I_D = 100\ \mu\text{A}$	
V_{GSmax}	Gate - Source Voltage	-10/+25	V	Absolute maximum values	
V_{GSop}	Gate - Source Voltage	-5/+20	V	Recommended operational values	
I_D	Continuous Drain Current	5.3	A	$V_{GS} = 20\text{ V}, T_C = 25^\circ\text{C}$	Fig. 19
		3.6		$V_{GS} = 20\text{ V}, T_C = 100^\circ\text{C}$	
$I_{D(pulse)}$	Pulsed Drain Current	6.0	A	Pulse width t_p limited by T_{jmax}	Fig. 22
P_D	Power Dissipation	78	W	$T_C = 25^\circ\text{C}, T_J = 150^\circ\text{C}$	Fig. 20
T_J, T_{stg}	Operating Junction and Storage Temperature	-55 to +150	$^\circ\text{C}$		
T_L	Solder Temperature	260	$^\circ\text{C}$	1.6mm (0.063") from case for 10s	

Electrical Characteristics ($T_C = 25^\circ\text{C}$ unless otherwise specified)

Symbol	Parameter	Min.	Typ.	Max.	Unit	Test Conditions	Note
$V_{(BR)DSS}$	Drain-Source Breakdown Voltage	1700			V	$V_{GS} = 0\text{ V}, I_D = 100\ \mu\text{A}$	
$V_{GS(th)}$	Gate Threshold Voltage	2.0	2.6	4	V	$V_{DS} = V_{GS}, I_D = 0.5\ \text{mA}$	Fig. 11
			2.1		V	$V_{DS} = V_{GS}, I_D = 0.5\ \text{mA}, T_J = 150^\circ\text{C}$	
I_{DSS}	Zero Gate Voltage Drain Current		1	100	μA	$V_{DS} = 1.7\ \text{kV}, V_{GS} = 0\ \text{V}$	
I_{GSS}	Gate-Source Leakage Current			250	nA	$V_{GS} = 20\ \text{V}, V_{DS} = 0\ \text{V}$	
$R_{DS(on)}$	Drain-Source On-State Resistance		1.0	1.4	Ω	$V_{GS} = 20\ \text{V}, I_D = 2\ \text{A}$	Fig. 4,5,6
			2.0			$V_{GS} = 20\ \text{V}, I_D = 2\ \text{A}, T_J = 150^\circ\text{C}$	
g_{fs}	Transconductance		0.82		S	$V_{DS} = 20\ \text{V}, I_{DS} = 2\ \text{A}$	Fig. 7
			0.81			$V_{DS} = 20\ \text{V}, I_{DS} = 2\ \text{A}, T_J = 150^\circ\text{C}$	
C_{iss}	Input Capacitance		200		pF	$V_{GS} = 0\ \text{V}$ $V_{DS} = 1000\ \text{V}$ $f = 1\ \text{MHz}$	Fig. 17,18
C_{oss}	Output Capacitance		12				
C_{riss}	Reverse Transfer Capacitance		1.3				
E_{oss}	C_{oss} Stored Energy		7		μJ	$V_{AC} = 25\ \text{mV}$	Fig. 16
E_{ON}	Turn-On Switching Energy		31		μJ	$V_{DS} = 1.2\ \text{kV}, V_{GS} = -5/20\ \text{V}$ $I_D = 2\ \text{A}, R_{G(ext)} = 2.5\ \Omega,$ $L = 1368\ \mu\text{H}, T_J = 150^\circ\text{C}$	Fig. 26
E_{OFF}	Turn Off Switching Energy		10				
$t_{d(on)}$	Turn-On Delay Time		4		ns	$V_{DD} = 1.2\ \text{kV}, V_{GS} = -5/20\ \text{V}$ $I_D = 2\ \text{A}, R_{G(ext)} = 2.5\ \Omega, R_L = 600\ \Omega$ Timing relative to V_{DS} Per IEC60747-8-4 pg 83	Fig. 27
t_r	Rise Time		4.8				
$t_{d(off)}$	Turn-Off Delay Time		10.8				
t_f	Fall Time		40.4				
$R_{G(int)}$	Internal Gate Resistance		24.8		Ω	$f = 1\ \text{MHz}, V_{AC} = 25\ \text{mV}$	
Q_{gs}	Gate to Source Charge		4.7		nC	$V_{DS} = 1.2\ \text{kV}, V_{GS} = -5/20\ \text{V}$ $I_D = 2\ \text{A}$ Per IEC60747-8-4 pg 21	Fig. 12
Q_{gd}	Gate to Drain Charge		5.4				
Q_g	Total Gate Charge		13				

Reverse Diode Characteristics

Symbol	Parameter	Typ.	Max.	Unit	Test Conditions	Note
V_{SD}	Diode Forward Voltage	3.8		V	$V_{GS} = -5\ \text{V}, I_{SD} = 1\ \text{A}, T_J = 25^\circ\text{C}$	Fig. 8, 9, 10
		3.3		V	$V_{GS} = -5\ \text{V}, I_{SD} = 1\ \text{A}, T_J = 150^\circ\text{C}$	
I_S	Continuous Diode Forward Current		4	A	$T_C = 25^\circ\text{C}$	Note 1
t_{rr}	Reverse Recovery Time	20		ns	$V_{GS} = -5\ \text{V}, I_{SD} = 2\ \text{A}, T_J = 25^\circ\text{C}$ $V_R = 1.2\ \text{kV}$ $dif/dt = 1200\ \text{A}/\mu\text{s}$	Note 1
Q_{rr}	Reverse Recovery Charge	24		nC		
I_{rrm}	Peak Reverse Recovery Current	6.5		A		

Note (1): When using SiC Body Diode the maximum recommended $V_{GS} = -5\text{V}$

Thermal Characteristics

Symbol	Parameter	Typ.	Max.	Unit	Test Conditions	Note
$R_{\theta JC}$	Thermal Resistance from Junction to Case	1.5	1.6	$^\circ\text{C}/\text{W}$		Fig. 21
$R_{\theta JA}$	Thermal Resistance from Junction to Ambient		40			

Typical Performance

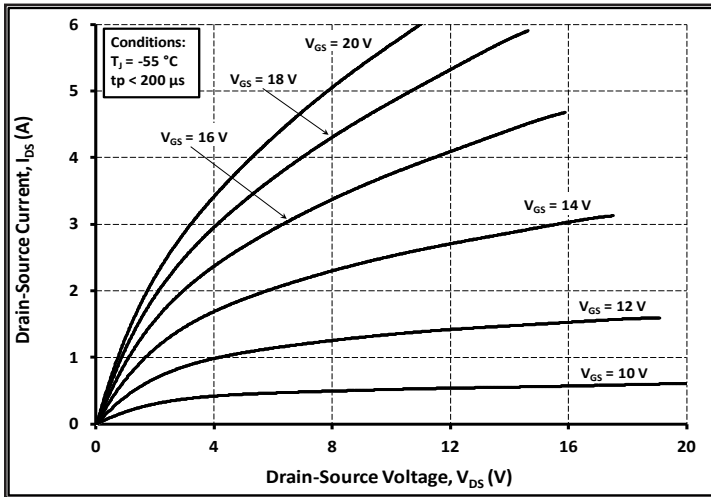

Figure 1. Output Characteristics $T_J = -55\text{ }^\circ\text{C}$

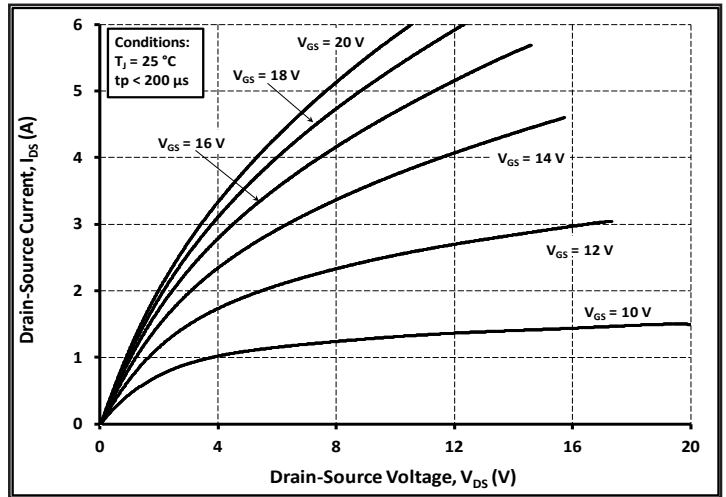

Figure 2. Output Characteristics $T_J = 25\text{ }^\circ\text{C}$

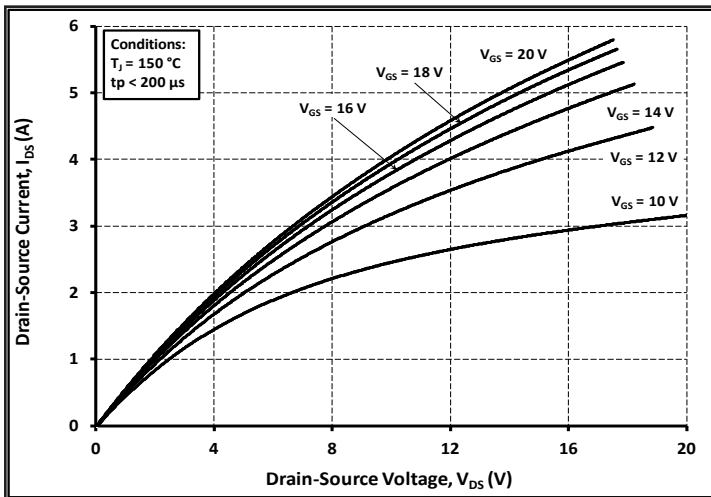

Figure 3. Output Characteristics $T_J = 150\text{ }^\circ\text{C}$

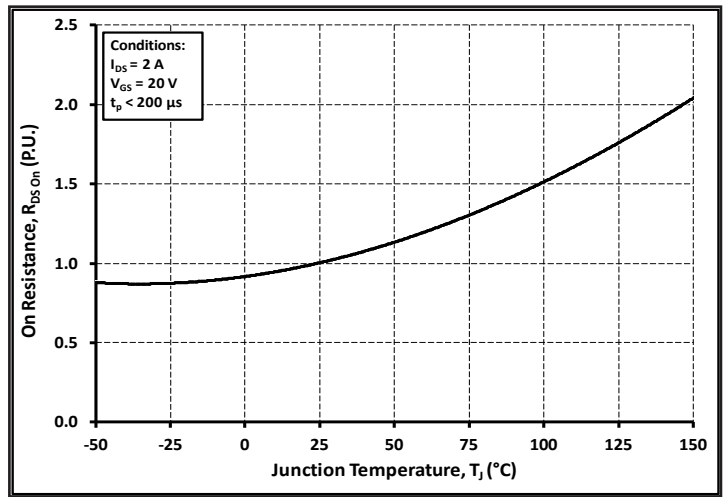

Figure 4. Normalized On-Resistance vs. Temperature

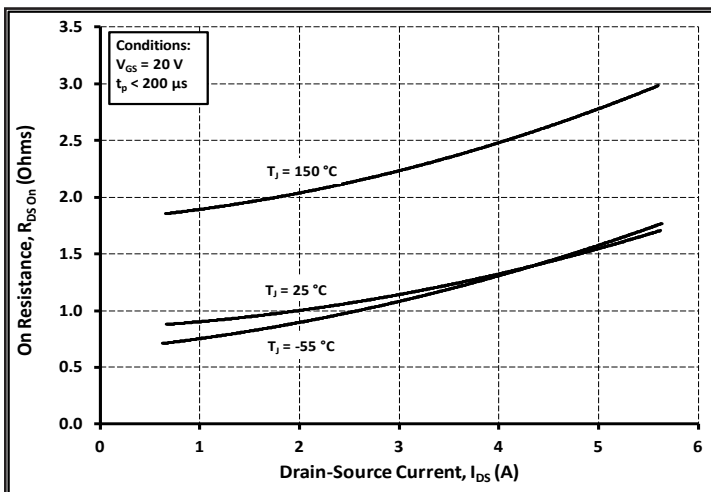

Figure 5. On-Resistance vs. Drain Current For Various Temperatures

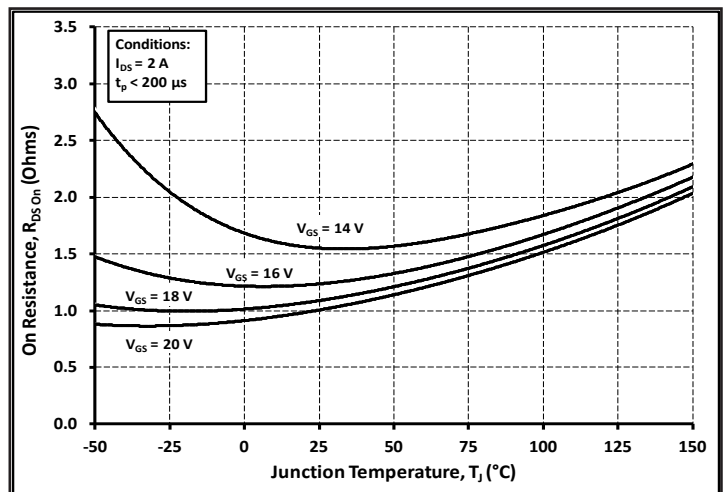

Figure 6. On-Resistance vs. Temperature For Various Gate Voltage

Typical Performance

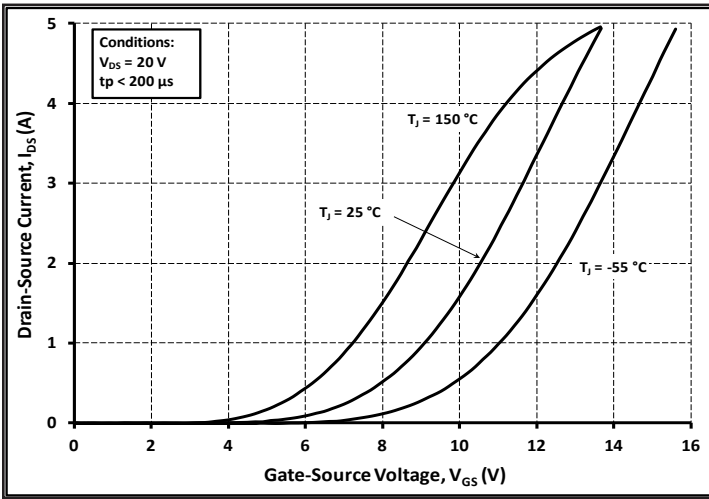

Figure 7. Transfer Characteristic for Various Junction Temperatures

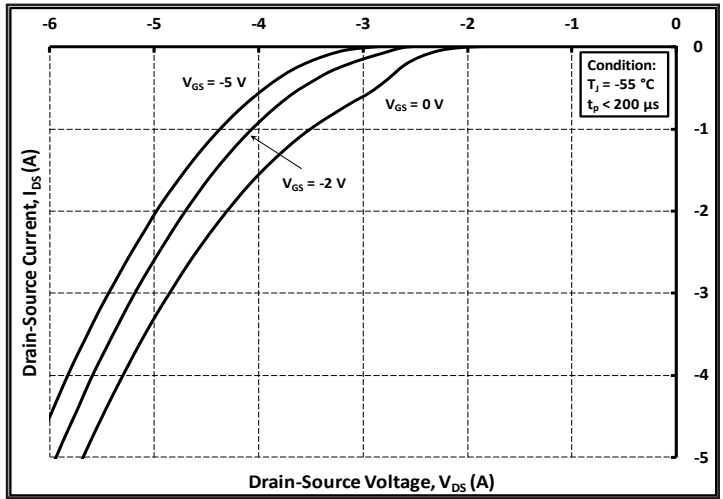

Figure 8. Body Diode Characteristic at -55 °C

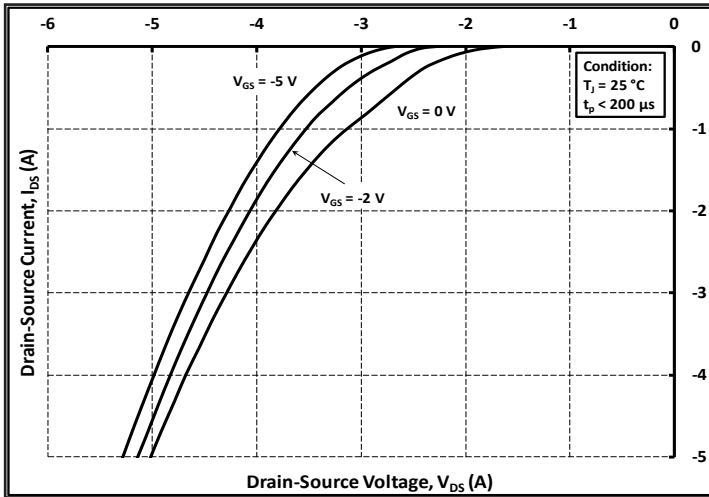

Figure 9. Body Diode Characteristic at 25 °C

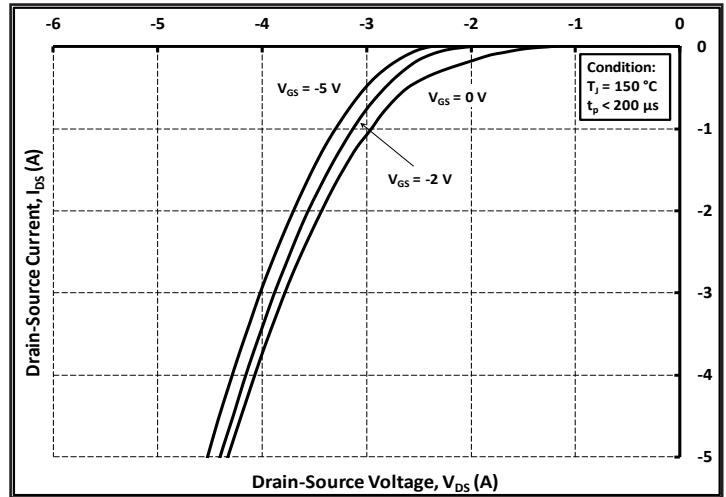

Figure 10. Body Diode Characteristic at 150 °C

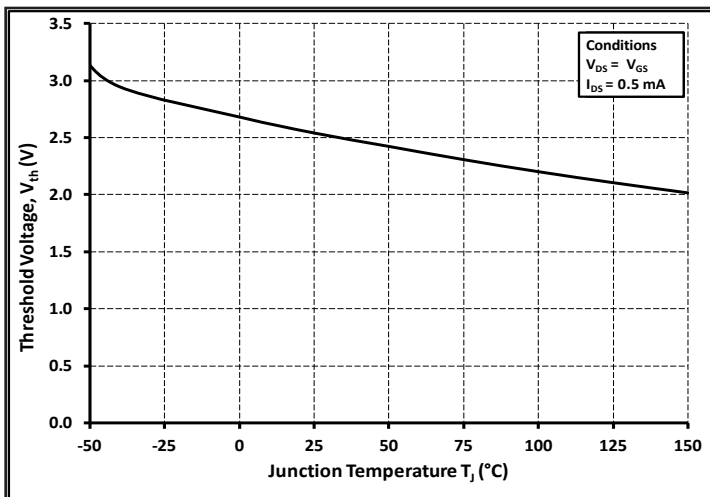

Figure 11. Threshold Voltage vs. Temperature

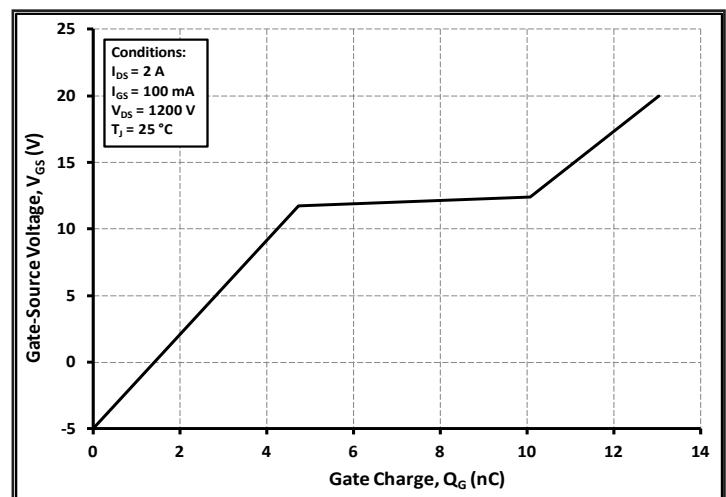

Figure 12. Gate Charge Characteristics

Typical Performance

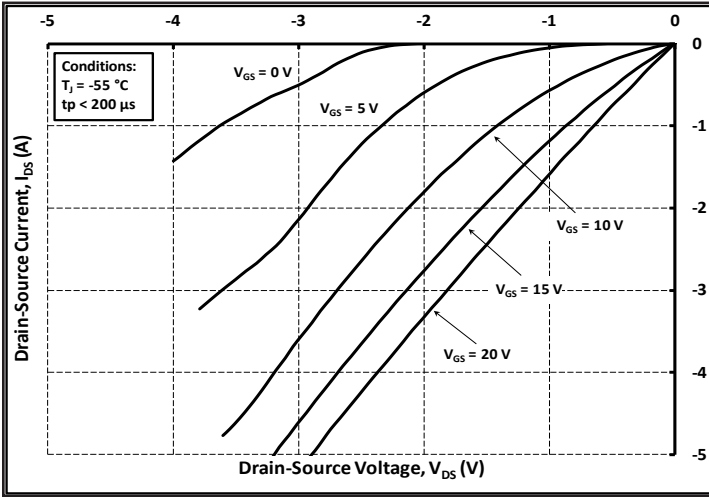

Figure 13. 3rd Quadrant Characteristic at -55 °C

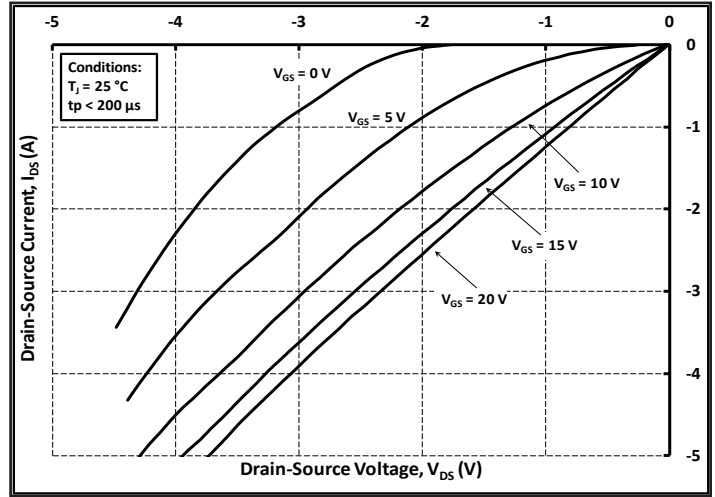

Figure 14. 3rd Quadrant Characteristic at 25 °C

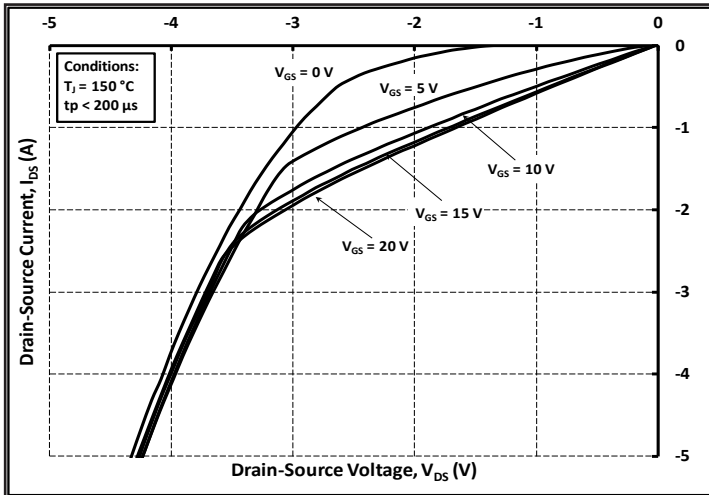

Figure 15. 3rd Quadrant Characteristic at 150 °C

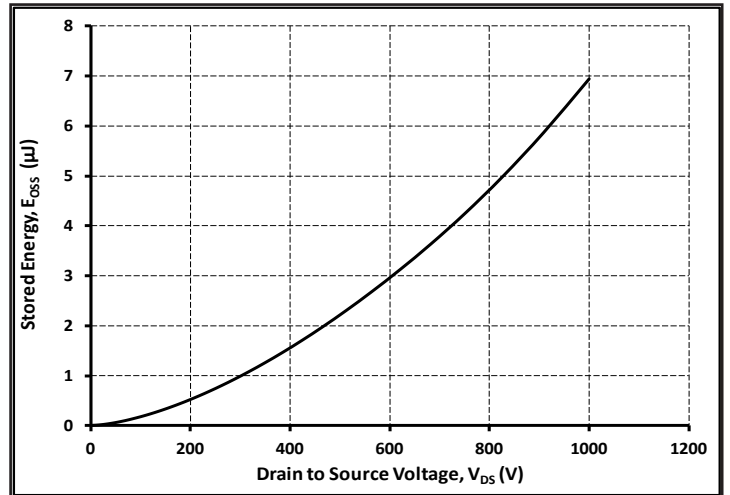

Figure 16. Output Capacitor Stored Energy

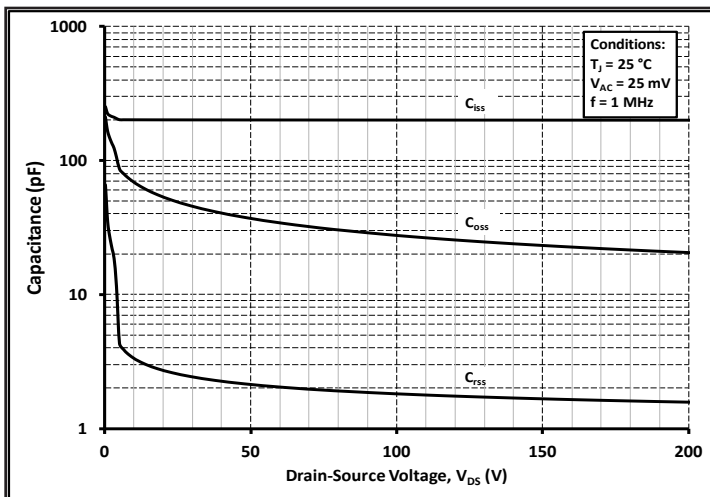

Figure 17. Capacitances vs. Drain-Source Voltage (0-200 V)

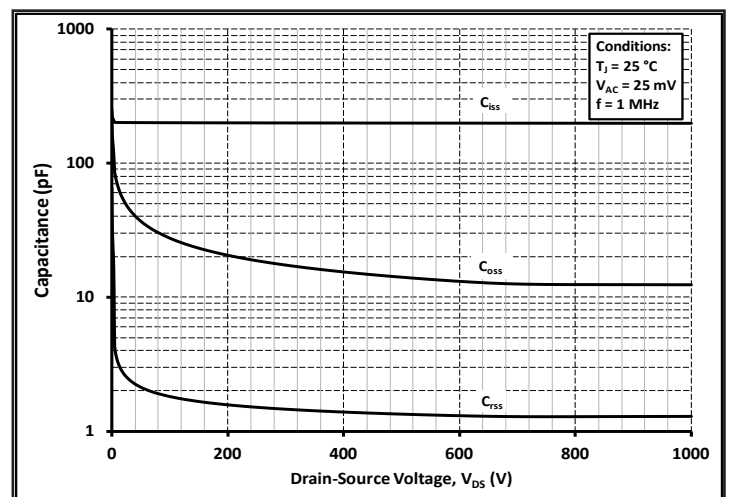

Figure 18. Capacitances vs. Drain-Source Voltage (0-1000 V)

Typical Performance

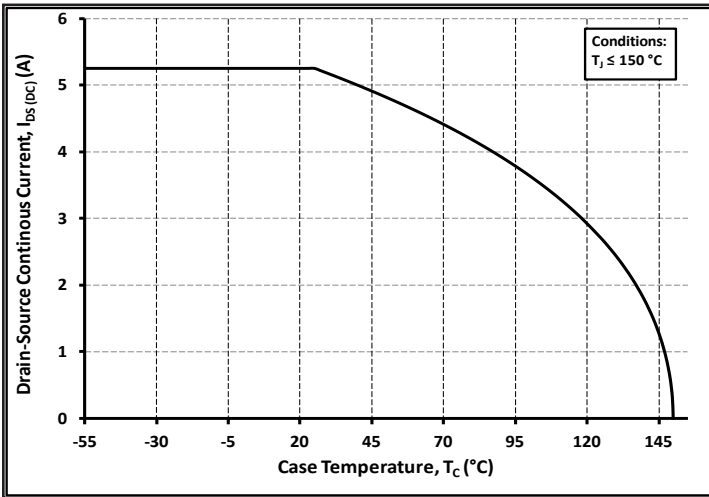

Figure 19. Continuous Drain Current Derating vs. Case Temperature

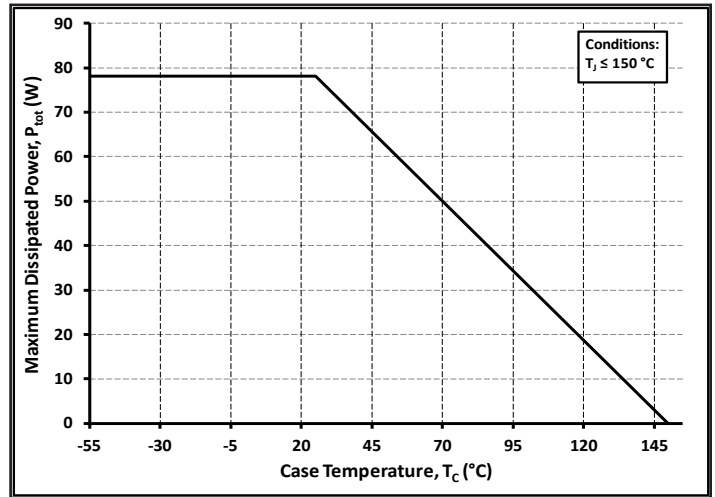

Figure 20. Maximum Power Dissipation Derating vs. Case Temperature

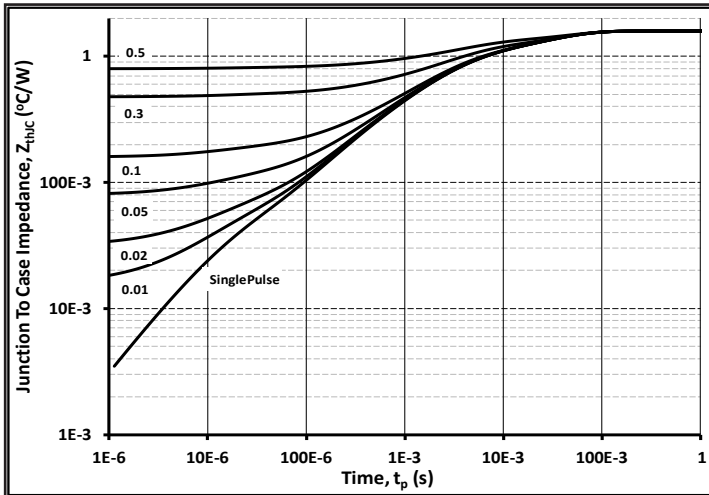

Figure 21. Transient Thermal Impedance (Junction - Case)

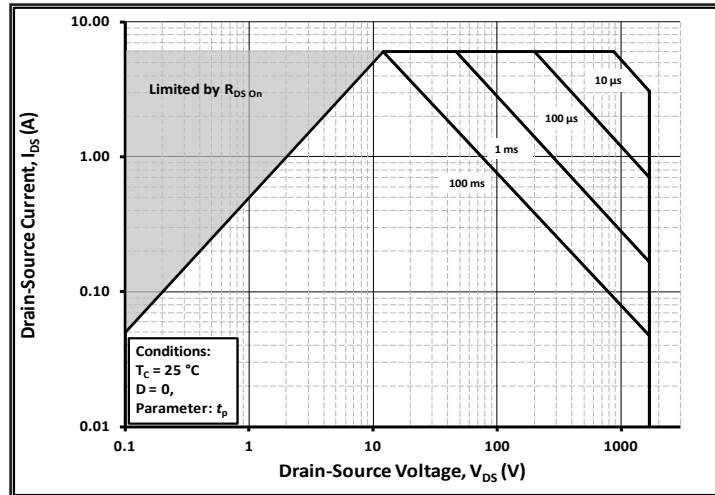

Figure 22. Safe Operating Area

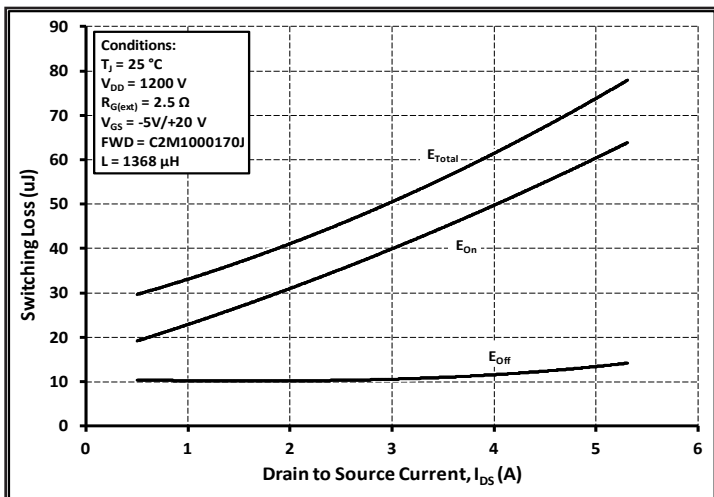

Figure 23. Clamped Inductive Switching Energy vs. Drain Current ($V_{DD} = 1200 \text{ V}$)

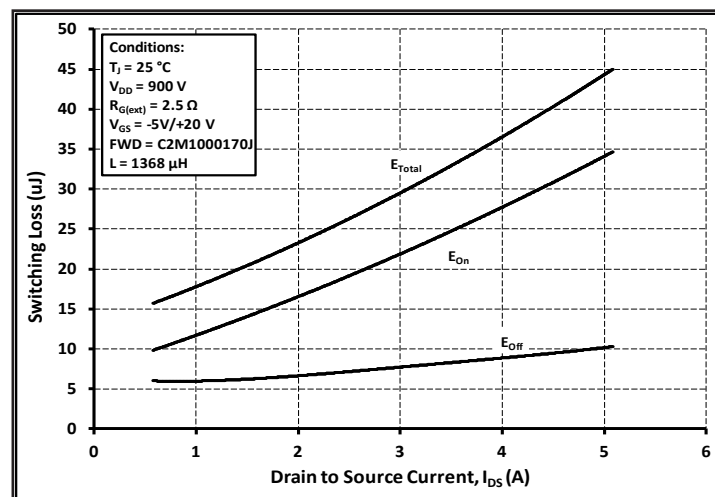

Figure 24. Clamped Inductive Switching Energy vs. Drain Current ($V_{DD} = 900 \text{ V}$)

Typical Performance

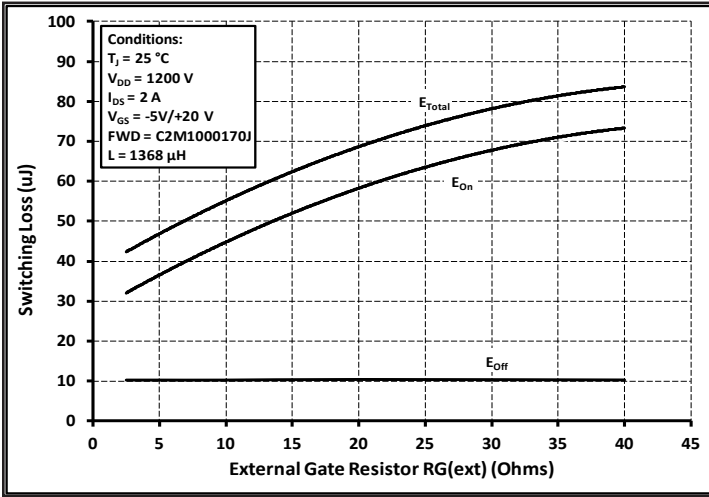

Figure 25. Clamped Inductive Switching Energy vs. $R_{G(ext)}$

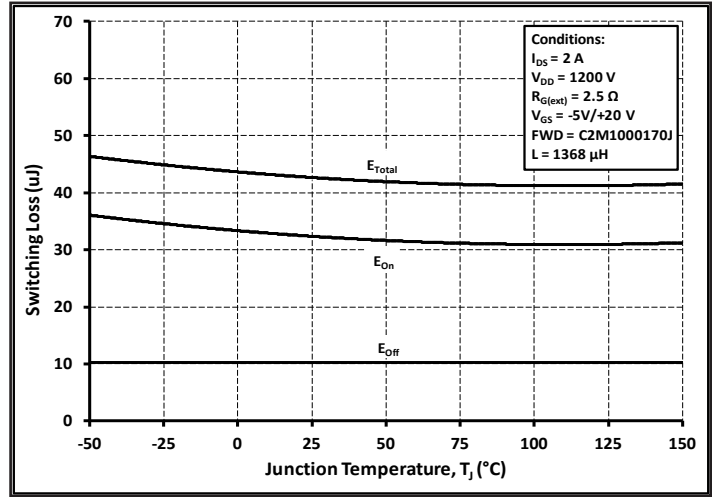

Figure 26. Clamped Inductive Switching Energy vs. Temperature

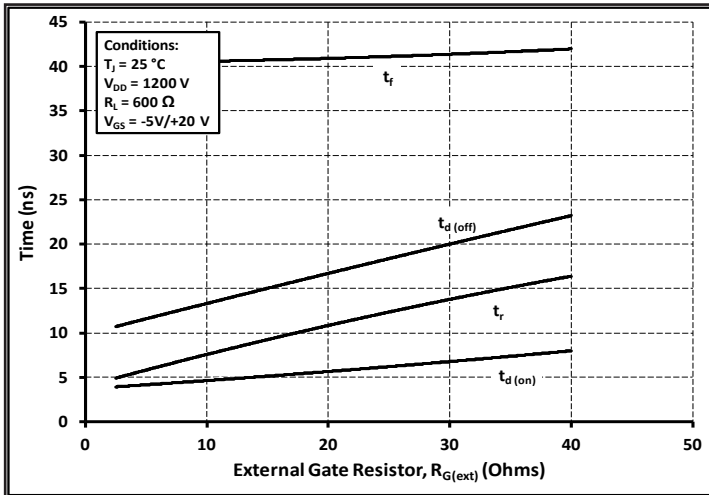

Figure 27. Switching Times vs. $R_{G(ext)}$

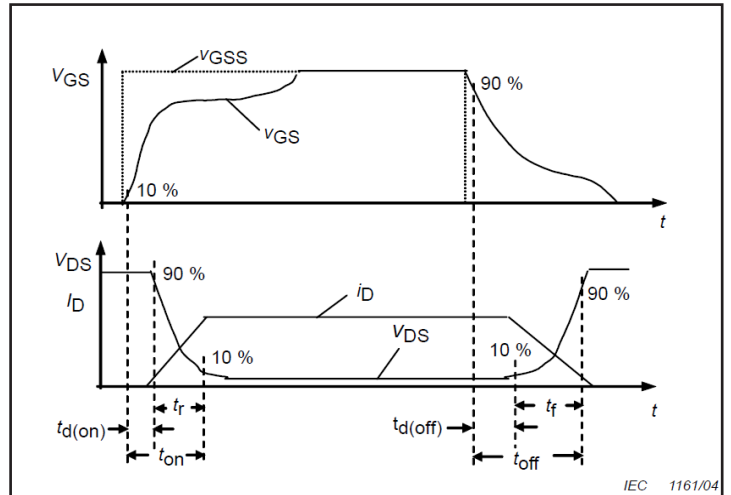

Figure 28. Switching Times Definition

Test Circuit Schematic

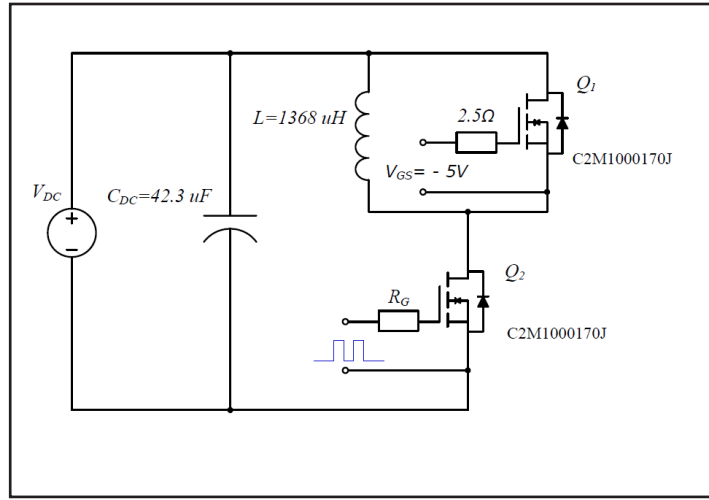

Figure 29. Clamped Inductive Switching Waveform Test Circuit

ESD Ratings

ESD Test	Total Devices Sampled	Resulting Classification
ESD-HBM	All Devices Passed 4000V	3A (>4000V)
ESD-MM	All Devices Passed 200V	A (>200V)
ESD-CDM	All Devices Passed 1000V	IV (>1000V)

Package Dimensions

Package 7L D2PAK

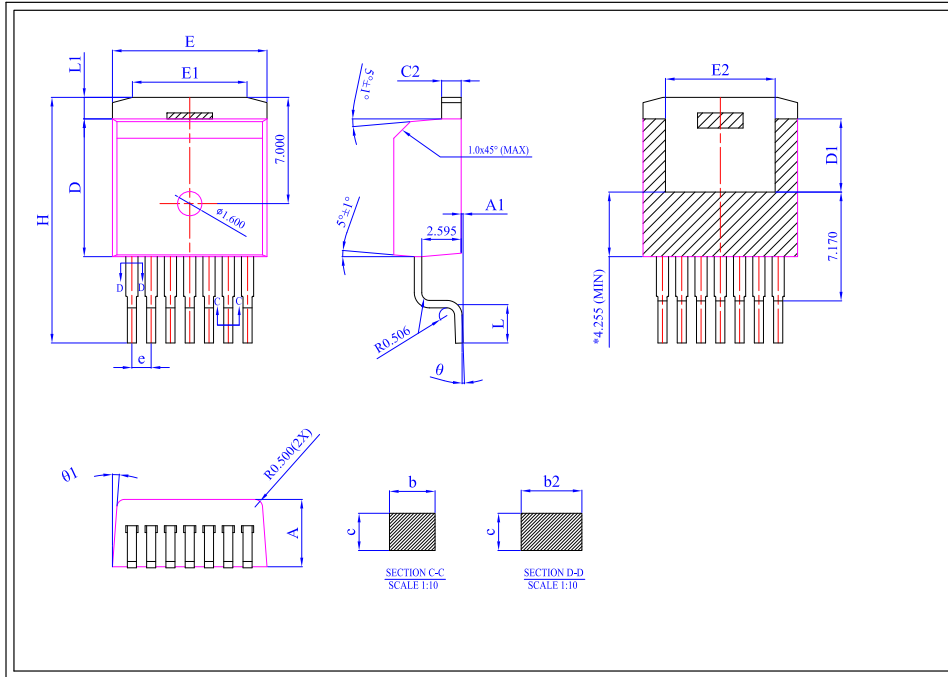

Dim	All Dimensions in Millimeters		
	Min	typ	Max
A	4.300	4.435	4.570
A1	0.00	0.125	0.25
b	0.500	0.600	0.700
b2	0.600	0.800	1.000
c	0.330	0.490	0.650
C2	1.170	1.285	1.400
D	9.025	9.075	9.125
D1	4.700	4.800	4.900
E	10.130	10.180	10.230
E1	6.500	7.550	8.600
E2	6.778	7.223	7.665
e	1.27		
H	15.043	16.178	17.313
L	2.324	2.512	2.700
L1	0.968	1.418	1.868
∅	0°	4°	8°
∅1	4.5°	5°	5.5°

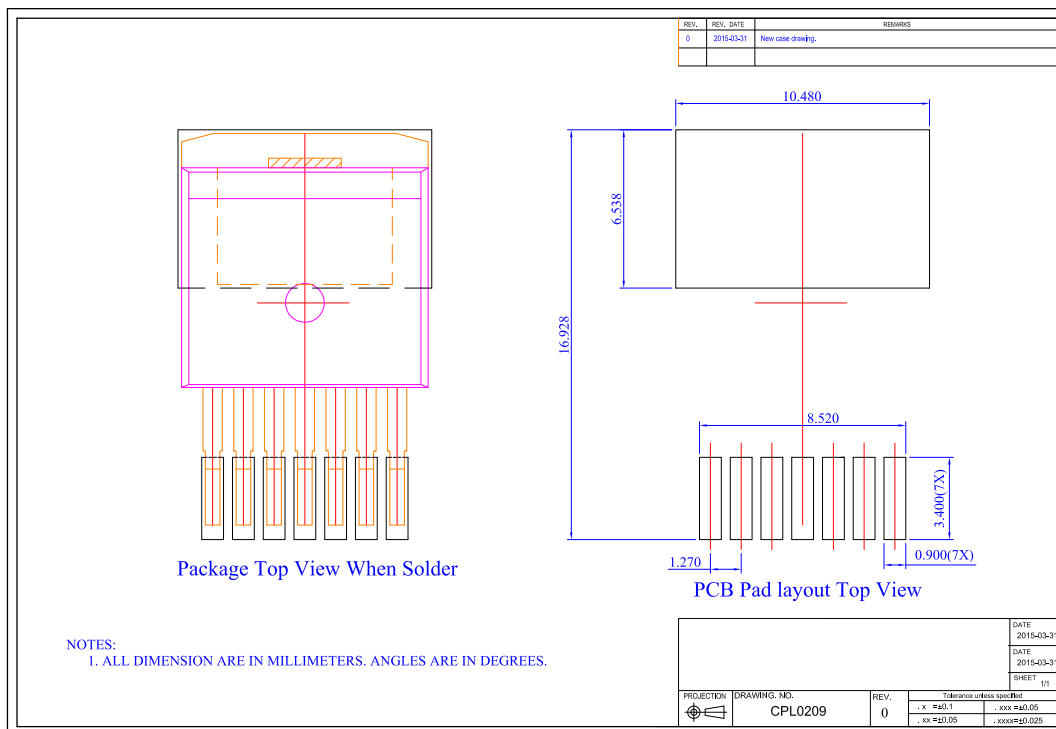

REV.	REV. DATE	REMARKS
0	2015-03-31	New case drawing.

PROJECTION	DRAWING. NO.	REV.	DATE
	CPL0209	0	2015-03-31

TOLERANCE UNLESS SPECIFIED	SHEET
.X = ±0.1	1/1
.XX = ±0.05	

Notes

- **RoHS Compliance**
The levels of RoHS restricted materials in this product are below the maximum concentration values (also referred to as the threshold limits) permitted for such substances, or are used in an exempted application, in accordance with EU Directive 2011/65/EC (RoHS2), as implemented January 2, 2013. RoHS Declarations for this product can be obtained from your Cree representative or from the Product Documentation sections of www.cree.com.
- **REACH Compliance**
REACH substances of high concern (SVHCs) information is available for this product. Since the European Chemical Agency (ECHA) has published notice of their intent to frequently revise the SVHC listing for the foreseeable future, please contact a Cree representative to insure you get the most up-to-date REACH SVHC Declaration. REACH banned substance information (REACH Article 67) is also available upon request.
- This product has not been designed or tested for use in, and is not intended for use in, applications implanted into the human body nor in applications in which failure of the product could lead to death, personal injury or property damage, including but not limited to equipment used in the operation of nuclear facilities, life-support machines, cardiac defibrillators or similar emergency medical equipment, aircraft navigation or communication or control systems, air traffic control systems.

Related Links

- **C2M PSPICE Models:** <http://wolfspeed.com/power/tools-and-support>
- **SiC MOSFET Isolated Gate Driver reference design:** <http://wolfspeed.com/power/tools-and-support>
- **SiC MOSFET Evaluation Board:** <http://wolfspeed.com/power/tools-and-support>
- **60W Auxiliary power supply reference design:** <http://wolfspeed.com/power/tools-and-support>



Компания «ЭлектроПласт» предлагает заключение долгосрочных отношений при поставках импортных электронных компонентов на взаимовыгодных условиях!

Наши преимущества:

- Оперативные поставки широкого спектра электронных компонентов отечественного и импортного производства напрямую от производителей и с крупнейших мировых складов;
- Поставка более 17-ти миллионов наименований электронных компонентов;
- Поставка сложных, дефицитных, либо снятых с производства позиций;
- Оперативные сроки поставки под заказ (от 5 рабочих дней);
- Экспресс доставка в любую точку России;
- Техническая поддержка проекта, помощь в подборе аналогов, поставка прототипов;
- Система менеджмента качества сертифицирована по Международному стандарту ISO 9001;
- Лицензия ФСБ на осуществление работ с использованием сведений, составляющих государственную тайну;
- Поставка специализированных компонентов (Xilinx, Altera, Analog Devices, Intersil, Interpoint, Microsemi, Aeroflex, Peregrine, Syfer, Eurofarad, Texas Instrument, Miteq, Cobham, E2V, MA-COM, Hittite, Mini-Circuits, General Dynamics и др.);

Помимо этого, одним из направлений компании «ЭлектроПласт» является направление «Источники питания». Мы предлагаем Вам помощь Конструкторского отдела:

- Подбор оптимального решения, техническое обоснование при выборе компонента;
- Подбор аналогов;
- Консультации по применению компонента;
- Поставка образцов и прототипов;
- Техническая поддержка проекта;
- Защита от снятия компонента с производства.



Как с нами связаться

Телефон: 8 (812) 309 58 32 (многоканальный)

Факс: 8 (812) 320-02-42

Электронная почта: org@eplast1.ru

Адрес: 198099, г. Санкт-Петербург, ул. Калинина, дом 2, корпус 4, литера А.