

TDTP4000W066B: 4kW Bridgeless Totem-pole PFC Evaluation Board

Overview

This user guide describes the TDTP4000W066B_0v1 4kW bridgeless totem-pole power factor correction (PFC) evaluation board. Very high efficiency single-phase AC-DC conversion is achieved with the TP65H035WS, a diode-free Gallium Nitride (GaN) FET bridge with low reverse-recovery charge. Using GaN FETs in the fast-switching leg of the circuit and low-resistance MOSFETs in the slow-switching leg of the circuit results in improved performance and efficiency. For more information and complete design files, please visit transphormusa.com/tp4kit. The TDTP4000W066B_0v1-KIT is for evaluation purposes only.

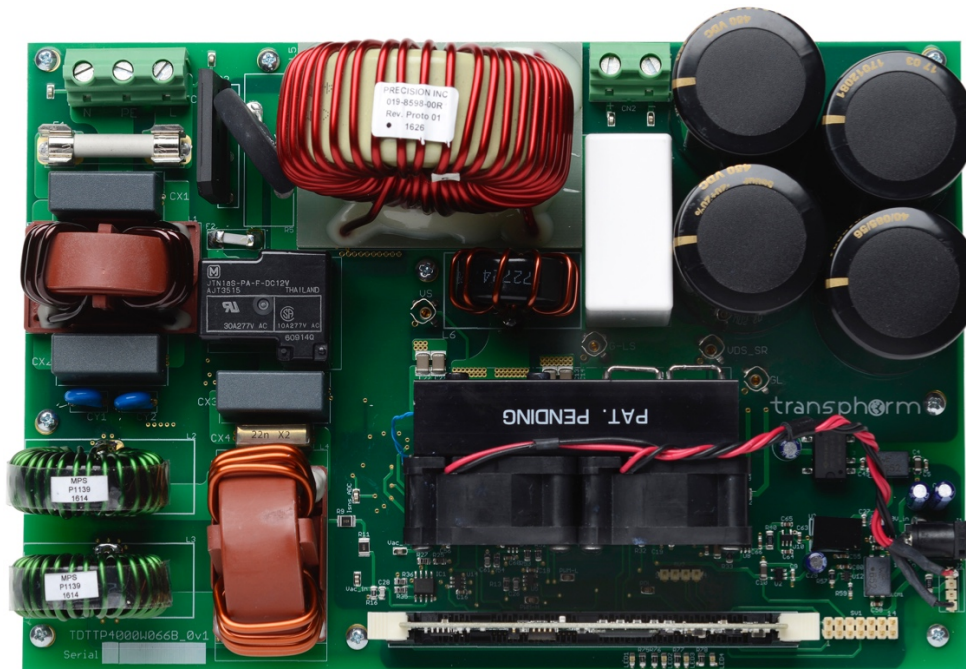

Figure 1. TDTP4000W066B_0v1 4kW totem-pole PFC evaluation board

Warning



This evaluation board is intended to demonstrate GaN FET technology and is for demonstration purposes only and no guarantees are made for standards compliance.

There are areas of this evaluation board that have exposed access to hazardous high voltage levels. Exercise caution to avoid contact with those voltages. Also note that the evaluation board may retain high voltage temporarily after input power has been removed. Exercise caution when handling.

When testing converters on an evaluation board, ensure adequate cooling. Apply cooling air with a fan blowing across the converter or across a heatsink attached to the converter. Monitor the converter temperature to ensure it does not exceed the maximum rated per the datasheet specification.

TDTP4000W066B User Guide

TDTP4000W066B input/output specifications

- Input voltage: 85V_{AC} to 265V_{AC}, 47Hz to 63Hz
- Input current: 18Arms; 2000W at 115V_{AC}, 4000W at 230V_{AC})
- 10% overload short time: 19.8Arms; 2200W at 115V_{AC}, 4400W at 230V_{AC})
- Ambient temperature: <50°C
- Output voltage: 387V_{DC} ± 5V_{DC}
- PWM frequency: 66kHz
- Auxiliary supply: 12V_{DC} for bias voltage
- Power dissipation in the GaN FET: Limited by the maximum junction temperature; refer to the [TP65H035WS](#) datasheet

Figure 2 shows the input and output connections. To reduce EMI noise, adding a ferrite core at both the input and output is recommended.

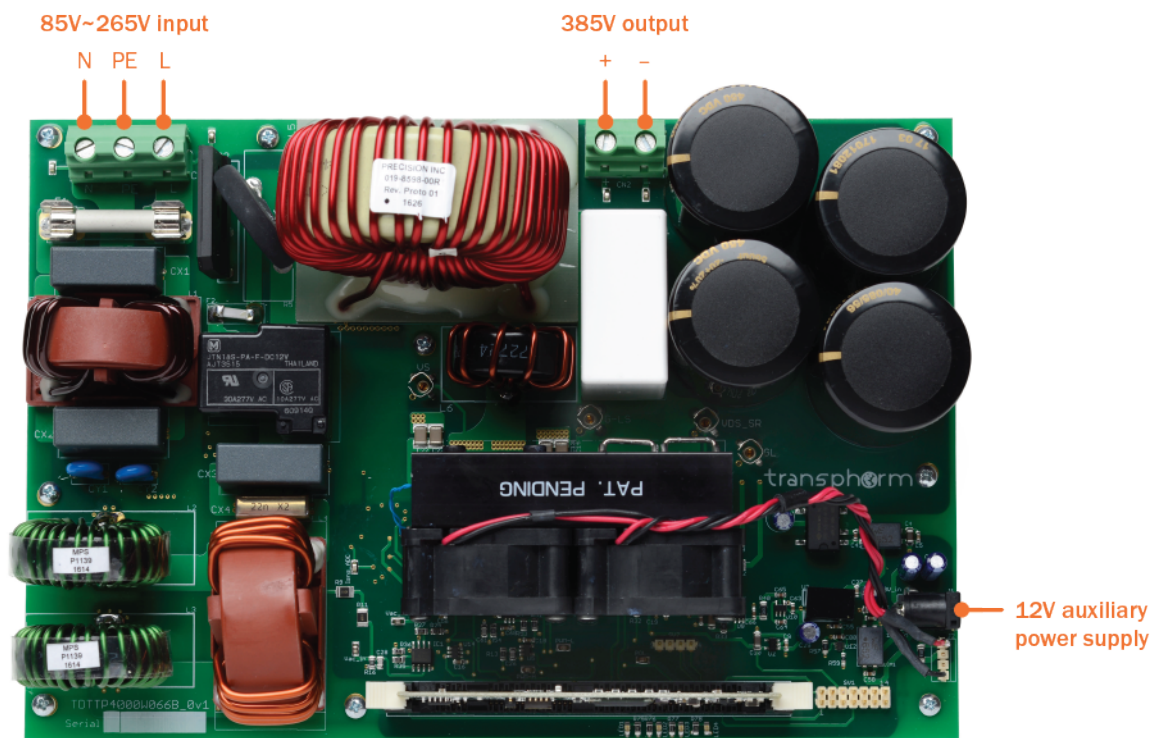

Figure 2. Input and output cable connections

Circuit description

The bridgeless totem-pole PFC topology is shown in Figure 3. Two GaN FETs and two low-resistance silicon (Si) MOSFETs are used to eliminate diode drops and improve efficiency. Further information and discussion on the performance and the characteristics of the bridgeless PFC circuit is provided in [1].

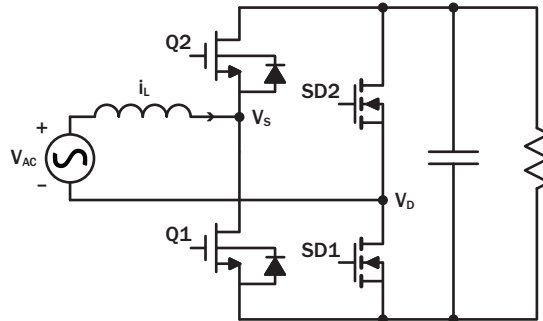

Figure 3. Bridgeless totem-pole PFC boost converter based on low-resistance MOSFETs for line rectification

Figure 4(a) is a simplified schematic of a totem-pole PFC in continuous conduction mode (CCM) mode, focused on minimizing conduction losses. It comprises two fast-switching GaN FETs (Q1 and Q2) operating at a high pulse-width-modulation (PWM) frequency and two very low-resistance MOSFETs (S1 and S2) operating at a much slower line frequency (50Hz/60Hz). The primary current path includes one fast switch and one slow switch only, with no diode drop. The function of S1 and S2 is that of a synchronized rectifier as illustrated in Figures 4(b) and 4(c). During the positive AC cycle, S1 is on and S2 is off, forcing the AC neutral line tied to the negative terminal to the DC output. The opposite applies for the negative cycle.

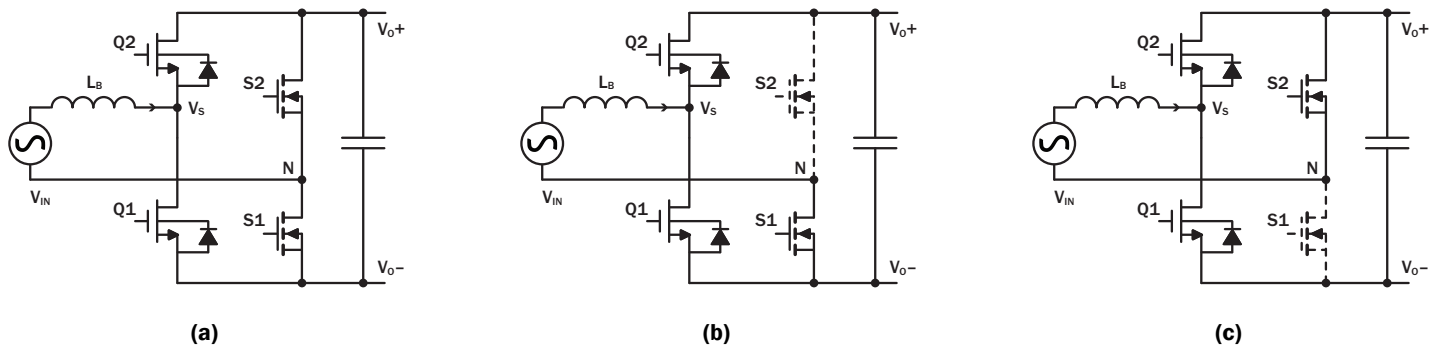

Figure 4. Totem-pole PFC with GaN FETs (a) simplified schematic, (b) during positive AC cycle and (c) during negative AC cycle

In either AC polarity, the two GaN FETs form a synchronized boost converter with one transistor acting as a master switch to allow energy intake by the boost inductor (L_B), and another transistor as a slave switch to release energy to the DC output. The roles of the two GaN devices interchange when the polarity of the AC input changes; therefore, each transistor must be able to perform both master and slave functions. To avoid shoot-through a dead time is built in between two switching events, during which both transistors are momentarily off. To allow CCM operation, the body diode of the slave transistor must function as a flyback diode for the inductor current to flow during dead time. The diode current; however, must quickly reduce to zero and transition to the reverse blocking state once the master switch turns on.

This is the critical process for a totem-pole PFC which, with the high Q_{rr} of the body diode of high-voltage Si MOSFETs, results in abnormal spikes, instability, and associated high switching losses. The low Q_{rr} of the GaN switches allows designers to overcome this barrier.

TDTTP4000W066B User Guide

As seen in Figure 5, inductive tests at 430V bus show healthy voltage waveforms up to inductor current exceeding 35A using either a high-side (Figure 5(a)) or low-side (Figure 5(b)) GaN transistor as a master switch. With a design goal of 4.4kW output power in CCM mode at 230V_{AC} input, the required inductor current is 20A. This test confirms a successful totem-pole power block with enough current overhead.

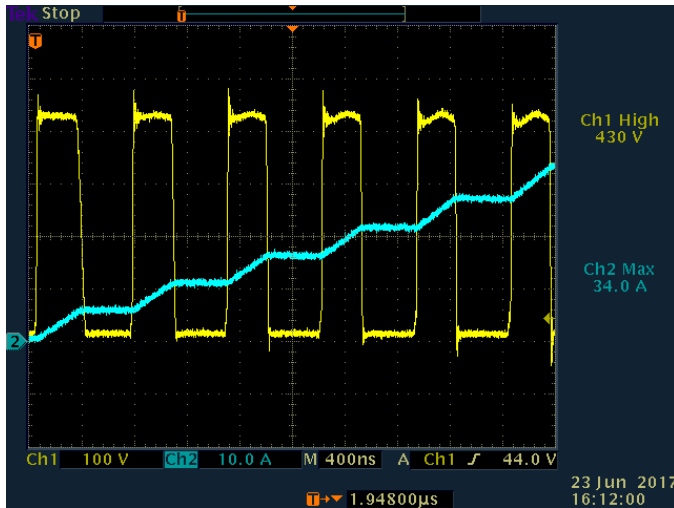

(a) High side

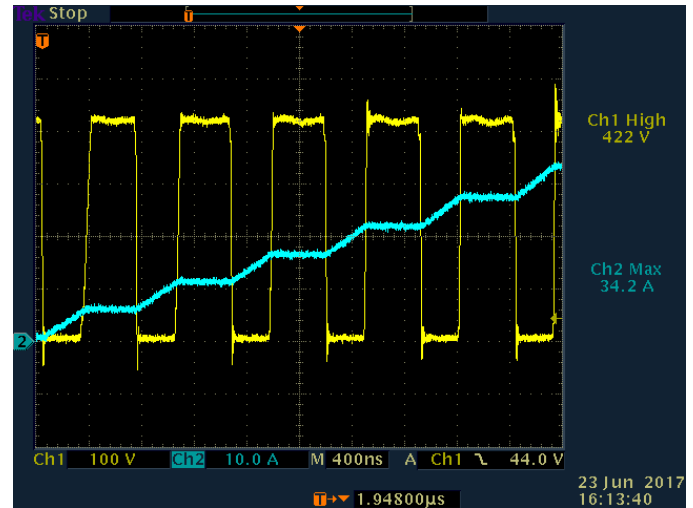

(b) Low side

Figure 5. Waveforms of two hard-switched GaN FETs when setting (a) high-side as a master and (b) low-side as a master

One issue inherent in the bridgeless totem-pole PFC is the operation mode transition at AC voltage zero-crossing. For instance, when the circuit operation mode changes from positive half-line to negative half-line at the zero-crossing, the duty ratio of the high-side GaN switch changes abruptly from almost 100% to 0% and the duty ratio of low-side GaN switch changes from 0% to 100%. Due to the slow reverse recovery of diodes (or body diode of a MOSFET), the voltage V_D cannot jump from ground to V_{DC} instantly; a current spike will be induced. To avoid the problem, a soft-start at every zero-crossing is implemented to gently reverse duty ratio (a soft-start time of a few switching cycles is enough). The TDTTP4000W066B evaluation board is designed to run in CCM and the larger inductance alleviates the current spike issue at zero-crossing.

Dead time control

The required form of the gate-drive signals is shown in Figure 5. The times marked A are the dead times when neither transistor is driven on. The dead time must be greater than zero to avoid shoot-through currents. The Si8230 gate drive chip ensures a minimum dead time based on the value of resistor R24, connected to the DT input. The dead time in ns is equal to the resistance in $k\Omega \times 10$, so the default value of 12k corresponds to 120ns. This will add to any dead time already present in the input signals. The on-board pulse generator circuit; for example, creates dead times of about 60ns (see Figure 6). The resulting dead time at the gate pins of Q1 and Q2 is about 120ns. Either shorting or removing R7 will reduce the dead time to 60ns.

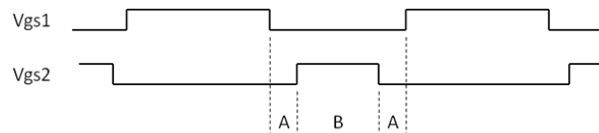

Figure 6. Non-overlapping gate pulses

TDTP4000W066B User Guide

While a typical Si MOSFET has a maximum dV/dt rating of 50V/ns, the TP65H035WS GaN FET will switch at dV/dt of 100V/ns or higher to achieve the lowest possible switching loss. At this level of operation, even the layout becomes a significant contributor to performance. As shown in Figure 8, the recommended layout keeps a minimum gate drive loop and keeps the traces between the switching nodes very short—with the shortest practical return trace to the power bus and ground. The power ground plane provides a large cross-sectional area to achieve an even ground potential throughout the circuit. The layout carefully separates the power ground and the IC (small signal) ground, only joining them at the source pin of the FET to avoid any possible ground loop.

Note that the Transphorm GaN FETs in TO-247 packages have pinout configuration of G-S-D, instead of the traditional G-D-S of a MOSFET. The G-S-D configuration is designed with thorough consideration to minimize the gate source driving loop, reducing parasitic inductance and to separate the driving loop (gate source) and power loop (drain source) to minimize noise. All PCB layers of the TDTP4000W066B_0V1 design are shown Figure 8(a-c) and available in the [design files](#).

Design details

A detailed circuit schematic is shown in Figures 7 and 8, the PCB layers in Figure 9, and the parts list in Table 1 (also included in the [design files](#)).

TDTP400W066B User Guide

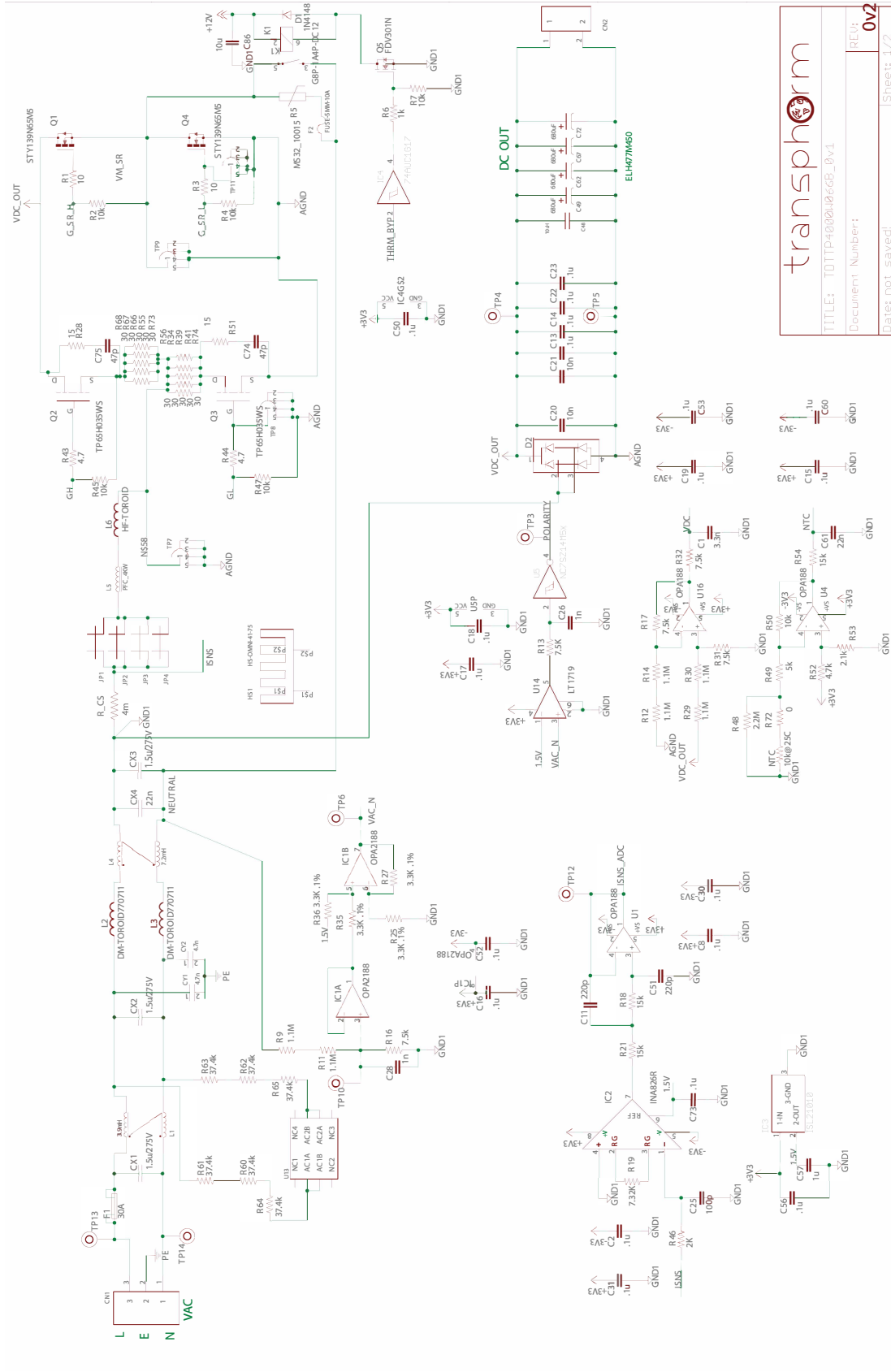

Figure 7. Detailed circuit schematic (1 of 2)



TITLE: TDTP400W066B_0v1
 Document Number:
 Date: not saved.

REV: **0v2**
 Sheet: 1/2

TDTTP4000W066B User Guide

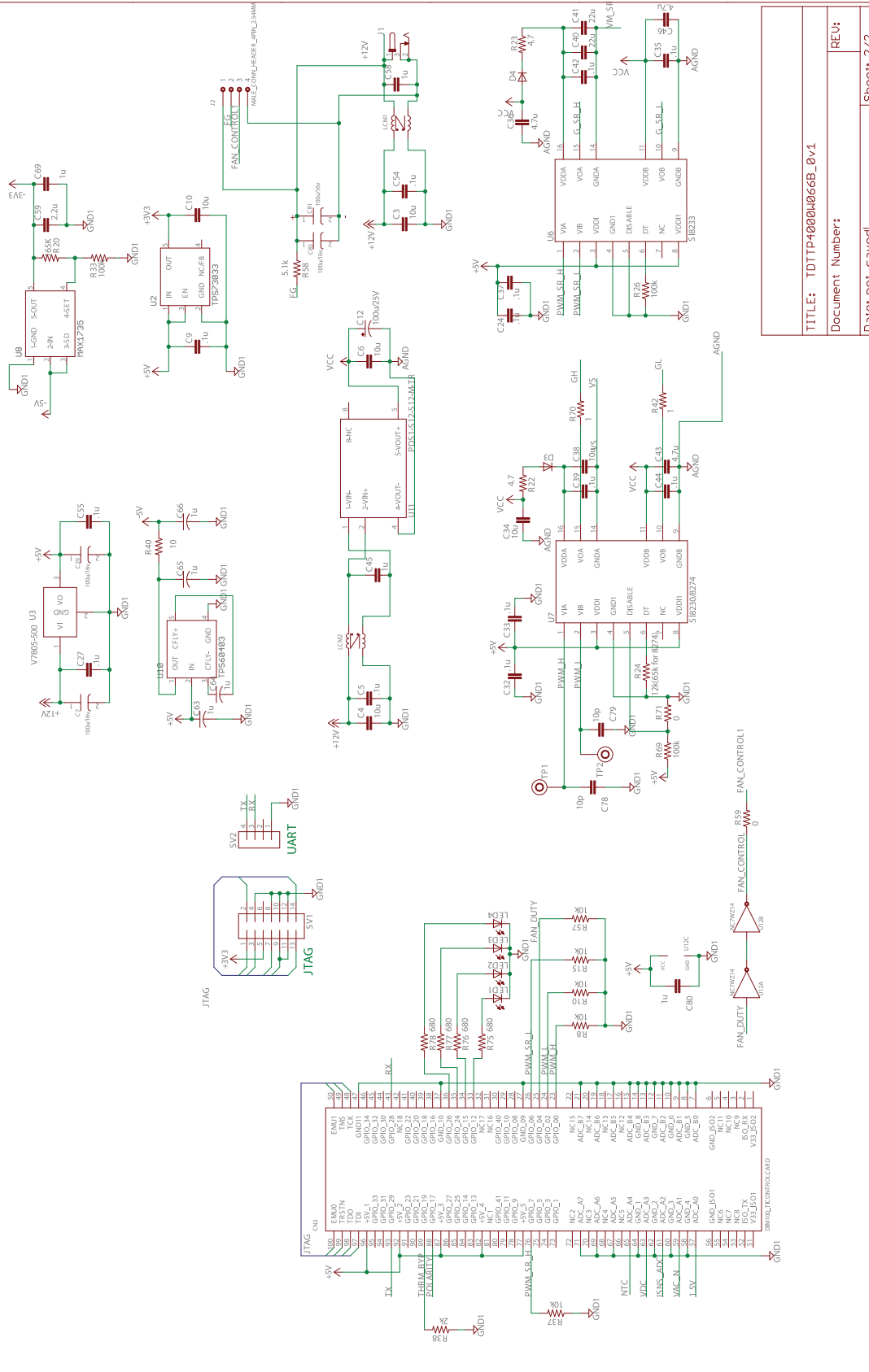

| |
|---------------------------|
| TITLE: TDTTP4000W066B_0v1 |
| Document Number: |
| Date: not saved! |
| Sheet: 2/2 |

Figure 8. Detailed circuit schematic (2 of 2)

TDTP4000W066B User Guide

Table 1. TDTP4000W066B evaluation board bill of materials (BOM)

| Designator | Qty | Value | Descriptor/Package | Manufacturer Part Number | Manufacturer |
|--|-----|---------------------|--------------------|--------------------------|--------------------|
| D3, D4 | 2 | | DO-214AC, SMA | ES1J | Micro Commercial |
| D2 | 1 | | 4-SIP, GBJ | GBJ2506-BP | Micro Commercial |
| LED1, LED2, LED3, LED4 | 4 | | 0805 (2012 metric) | SML-211UTT86 | ROHM Semiconductor |
| SV2 | 1 | | MA04-1 | 961104-6404-AR | 3M |
| SV1 | 1 | | MA07-2 | 67996-114HLF | FCI |
| J1 | 1 | | | PJ-002AH | CUI |
| TP7, TP8, TP9, TP11 | 4 | | Probe connector | 131-4353-00 | Tektronix |
| TP1, TP2, TP3, TP4, TP5, TP6, TP10, TP12, TP13, TP14 | 10 | | | 5015 | Keystone |
| C2, C5, C8, C9, C15, C16, C17, C18, C19, C24, C27, C30, C31, C32, C33, C35, C37, C39, C42, C44, C50, C52, C53, C54, C55, C56, C60, C73 | 28 | 0.1μF | C0603 | C0603C104J3RACTU | Kemet |
| C13, C14, C22, C23 | 4 | 0.1μF | C1812 | C1812V104KDRACTU | Kemet |
| R59, R71 | 2 | 0 | R0603 | RCS06030000Z0EA | Vishay |
| R72 | 1 | 0 | R0805 | RC0805JR-070RL | Yageo |
| R42, R70 | 2 | 1Ω | R0805 | RMCF0805FT1R00 | Stackpole |
| R9, R11, R12, R14, R29, R30 | 6 | 1.1MΩ | R1210 | KTR25JZPF1104 | ROHM Semiconductor |
| CX1, CX2, CX3 | 3 | 1.5μF/275V | Radial | 155MKP275KG | Illinois Capacitor |
| R1, R3 | 2 | 10Ω | R0805 | ERJ-6GEYJ100V | Panasonic |
| R40 | 1 | 10Ω | R1206 | ERJ-6ENF10ROV | Panasonic |
| R26, R33 | 2 | 100kΩ | R0805 | RJ-6ENF1003V | Panasonic |
| C25 | 1 | 100pF | C0603 | 06035A101FAT2A | AVX Corporation |
| C7, C29, C81, C85 | 4 | 100μF/16V | Radial, Can | UKL1C101KPDANA | Nichicon |
| C12 | 1 | 100μF/25V | Radial, Can | ESK107M025AC3AA | Kemet |
| R2, R4, R7, R8, R10, R15, R37, R45, R47, R50, R57 | 11 | 10kΩ | R0805 | ERJ-6ENF1002V | Panasonic |
| NTC | 1 | 10kΩ @25 °C | Ring Lug | B57703M103G40 | EPCOS (TDK) |
| C20, C21 | 2 | 10nF | C1206 | SMK316B7103KF-T | Taiyo Yuden |
| C78, C79 | 2 | 10pF | C0603 | C0603C100K3GACTU | Kemet |
| C86 | 1 | 10μF | C0805 | GRM21BR61E106KA73L | Murata |
| C3, C4, C6, C10, C34, C38 | 6 | 10μF | C1206 | 12063D106KAT2A | AVX |
| C48 | 1 | 10μH | Radial - 4 Leads | C4ATGBW5100A3FJ | Kemet |
| R24 | 1 | 12kΩ (65k for 8274) | R0805 | RC0805FR-0712KL | Yageo |
| R28, R51 | 2 | 15Ω | R1210 | RMCF1210FT15R0 | Stackpole |
| R18, R21, R54 | 3 | 15kΩ | R0805 | 05FR-0715KL | Yageo |
| R20 | 1 | 165kΩ | R0805 | ERJ-6ENF1653V | Panasonic |
| D1 | 1 | | SOD-123 | 1N4148W-E3-18 | Vishay |
| R6 | 1 | 1kΩ | R0805 | ERJ-6ENF1001V | Panasonic |
| C26, C28 | 2 | 1nF | C0805 | CC0805KRX7R9BB102 | Yageo |
| C45, C57, C58, C69, C80, C63, C64, C65, C66 | 9 | 1μF | C0603 | TMK107B7105KA-T | Taiyo Yuden |
| R53 | 1 | 2.1kΩ | R0805 | RC0805FR-072K1L | Yageo |
| R48 | 1 | 2.2MΩ | R0805 | RMCF0805JT2M20 | Stackpole |
| C59 | 1 | 2.2μF | C1206 | CL31B225KAHNNNE | Samsung Electro |
| C11, C51 | 2 | 220pF | C0805 | CC0805KRX7R9BB221 | Yageo |
| C61 | 1 | 22nF | C0805 | C2012C0G1V223J060AC | TDK |
| CX4 | 1 | 22nF | ECQ-U2A224ML | PME271M522MR30 | Kemet |
| C40, C41 | 2 | 22μF | C1206 | CL31X226KAHN3NE | Samsung Electro |

TDTP4000W066B User Guide

| Designator | Qty | Value | Descriptor/Package | Manufacturer Part Number | Manufacturer |
|--|-----|------------|----------------------------------|--------------------------|-------------------------------|
| R38, R46 | 1 | 2kΩ | R0805 | ERJ-6ENF2001V | Panasonic |
| CN2 | 1 | | 2PIN_9.53MM | 20020705-M021B01LF | FCI |
| R25, R27, R35, R36 | 4 | 3.3kΩ 0.1% | R0805 | ERA-6AEB332V | Panasonic |
| C1 | 1 | 3.3nF | C0805 | C0805C332K5RACTU | Kemet |
| L1 | 1 | 3.9mH | CMC_42X27MM_SM | T60405-R6128-X225 | Vacuumschmelze |
| R34, R39, R41, R55, R56, R66, R67, R68, R73, R74 | 10 | 30Ω | R0805 | BLM21SN300SH1D | Murata |
| F1 | 1 | 30A | SH32 | 01020078H | Littelfuse |
| R60, R61, R62, R63, R64, R65 | 6 | 37.4kΩ | R1206 | RC1206FR-0737K4L | Yageo |
| CN1 | 1 | | 3PIN 9.53MM | 20020316-H031B01LF | FCI |
| R43, R44 | 2 | 4.7Ω | R0805 | RNCP0805FTD4R70 | Stackpole |
| R22, R23 | 2 | 4.7Ω | R1206 | CRM1206-JW-4R7ELF | Bourns |
| R52 | 1 | 4.7kΩ | R0805 | RC0805FR-074K7L | Yageo |
| CY1, CY2 | 2 | 4.7nF | VY2_CAP_SAFETY | B32021A3472M | EPCOS (TDK) |
| C36, C43, C46 | 3 | 4.7μF | C1206 | CL31B475KBHNNNE | Samsung Electro |
| C74, C75 | 2 | 47pF | C1206 | CC1206JKNPOZBN470 | Yageo |
| R_CS | 1 | 4mΩ | Wide 2827 | CSSH2728FT4L00 | Stackpole |
| R58 | 1 | 5.1kΩ | R1206 | RC1206FR-075K1L | Yageo |
| R49 | 1 | 5kΩ | R0805 | RC0805FR-075K1L | Yageo |
| R75, R76, R77, R78 | 4 | 680Ω | R0805 | RC0805FR-07680RL | Yageo |
| C49, C62, C67, C72 | 4 | 560μF | ELE_CAP_D35MM_P10 | ALC10A561DF450 | Kemet |
| L4 | 1 | 7.2mH | CMC_42X27MM | T60405-R6128-X230 | Vacuumschmelze |
| R19 | 1 | 7.32kΩ | R0805 | RC0805FR-077K32L | Yageo |
| R13 | 1 | 7.5kΩ | R0805 | ERJ-6ENF7501V | Panasonic |
| R16, R17, R31, R32 | 4 | 7.5kΩ | R0805 | RN73C2A7K5BTDF | Panasonic |
| IC4 | 1 | | SOT-23-5 | SN74LVC1G17DBVR | Texas Instruments |
| LCM1, LCM2 | 2 | | CMC_WURTH_744229 | 744229 | Wurth |
| CN3 | 1 | | DIM100 | 5390213-1 | TE Connectivity |
| L2, L3 | 2 | | DM-77071B | CWS-1SN-12606 | CWS |
| Q5 | 1 | | SOT-23 | FDV301N | Fairchild/ON Semiconductor |
| F2 | 1 | 10A | SMM-FUSE | 65800003109 | Littelfuse |
| K1 | 1 | | G8P-1A4P | JTN1AS-PA-F-DC12V | Panasonic Electric Works |
| L6 | 1 | | DM-77894-AWG11 | CWS-1SN-12554 | CWS |
| HS1 | 1 | | HS-OMNI-41-75 | OMNI-UNI-41-75 | Wakefield-Vette |
| IC2 | 1 | | S08 | INA826AID | Texas Instruments |
| IC3 | 1 | | SOT-23-3 | ISL21010CFH315Z-TK | Intersil |
| JP1, JP2, JP3, JP4 | 4 | | JUMPER-S1621-46R | S1621-46R | Harwin Inc |
| U14 | 1 | | TSOT-23 | LT1719CS6#TRMPBF | Linear Technology |
| J2 | 1 | | MALE_CONN_HEADER_4PIN_2.54MM | 961104-6404-AR | 3M |
| U8 | 1 | | SOT-23-5 | MAX1735EUK50+T | Maxim Integrated |
| R5 | 1 | | MS35_10018 | MS32 10015-B | Ametherm |
| U5 | 1 | | SOT-23-5 | NC7SZ14M5X | Fairchild/ON Semiconductor |
| U12 | 1 | | SC70 | NC7WZ14P6X | Fairchild/ON Semiconductor |
| U13 | 1 | | SOIC-8 | NCP4810DR2G | ON Semiconductor |
| U1, U4, U16 | 3 | | SOT-23-5 | OPA188AIDBVT | Texas Instruments |
| IC1 | 1 | | S08 | OPA2188AIDR | Texas Instruments |
| U11 | 1 | | 8-SMD Module, 5 Leads, Gull Wing | PDS1-S12-S12-M-TR | CUI |
| L5 | 1 | | PFC_4KW | 019-8598-00R | Precision |
| U7 | 1 | | SOIC16N | SI8230BB-D-IS1 | Silicon Labs |
| U6 | 1 | | SOIC16N | SI8233BB-D-IS1 | Silicon Labs |
| Q1, Q4 | 2 | | TO-247AD-V | STY139N65M5 | STMicroelectronics |
| Q2, Q3 | 2 | | TO-247 | TP65H035WS | Transphorm |

TDTP4000W066B User Guide

| Designator | Qty | Value | Descriptor/Package | Manufacturer Part Number | Manufacturer |
|------------|-----|-------|-------------------------------------|--------------------------|-------------------|
| U10 | 1 | | SOT-23-5 | TPS60403DBVR | Texas Instruments |
| U2 | 1 | | SOT-23-5 | TPS73033DBVR | Texas Instruments |
| U3 | 1 | | 3-SIP Module | V7805-500 | CUI |
| | 1 | | Control Card | TMS320F28335 | Texas Instruments |
| | 9 | | Standoff (nylon 1/2) | 1902C | Keystone |
| | 9 | | Machine Screw (ss 1/2) | 9902 | Keystone |
| | 2 | | Thermal Pad for Q2, Q3 | 4169G | Avid Thermollogy |
| | 2 | | 6/32 Screws for FETs to HS (Q2, Q3) | | |

For TDTP4000W066B evaluation board, the PFC circuit has been implemented on a 4-layer PCB. The GaN FET half-bridge is built with Transphorm's TP65H035WS (35mΩ) GaN FET. The slow Si switches are STY139N65M5 (17mΩ) superjunction MOSFETs. The inductor is made of a High Flux core with an inductance of 480μH and a DC resistance of 25mΩ and designed to operate at 66kHz. A simple 0.5A rated high/low side driver IC (Si8230) with 0/12V as on/off states directly drives each GaN FET. A 150MHz DSP (TMS320F28335) handles the control algorithm. The voltage and current loop controls are similar to a conventional boost PFC converter. The feedback signals are DC output voltage (V_o), AC input potentials (V_{ACP} and V_{ACN}) and inductor current (I_L). The input voltage polarity and RMS value are determined from V_{ACP} and V_{ACN} . The outer voltage loop output multiplied by $|V_{AC}|$ gives a sinusoidal current reference. The current loop gives the proper duty ratio for the boost circuit. The polarity determines how PWM signal is distributed to drive Q1 and Q2. A soft-start sequence with a duty ratio ramp is employed for a short period at each AC zero-crossing for better stability.

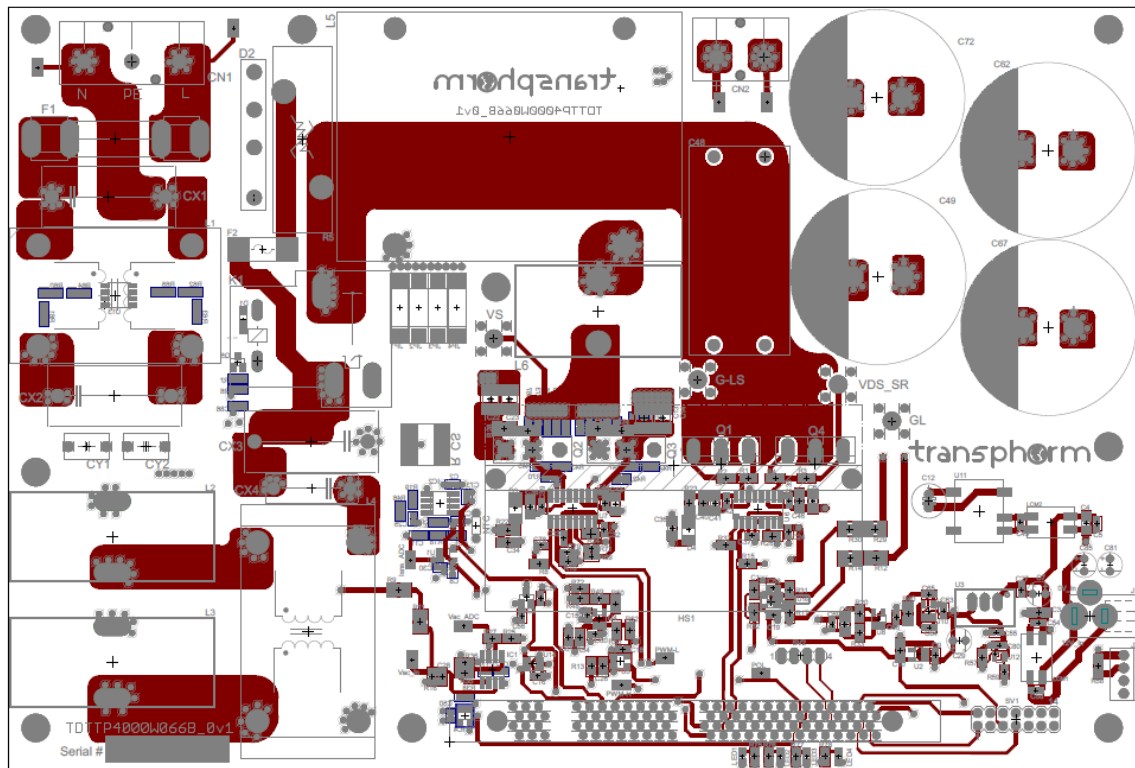

(a) PCB top layer

TDTTP4000W066B User Guide

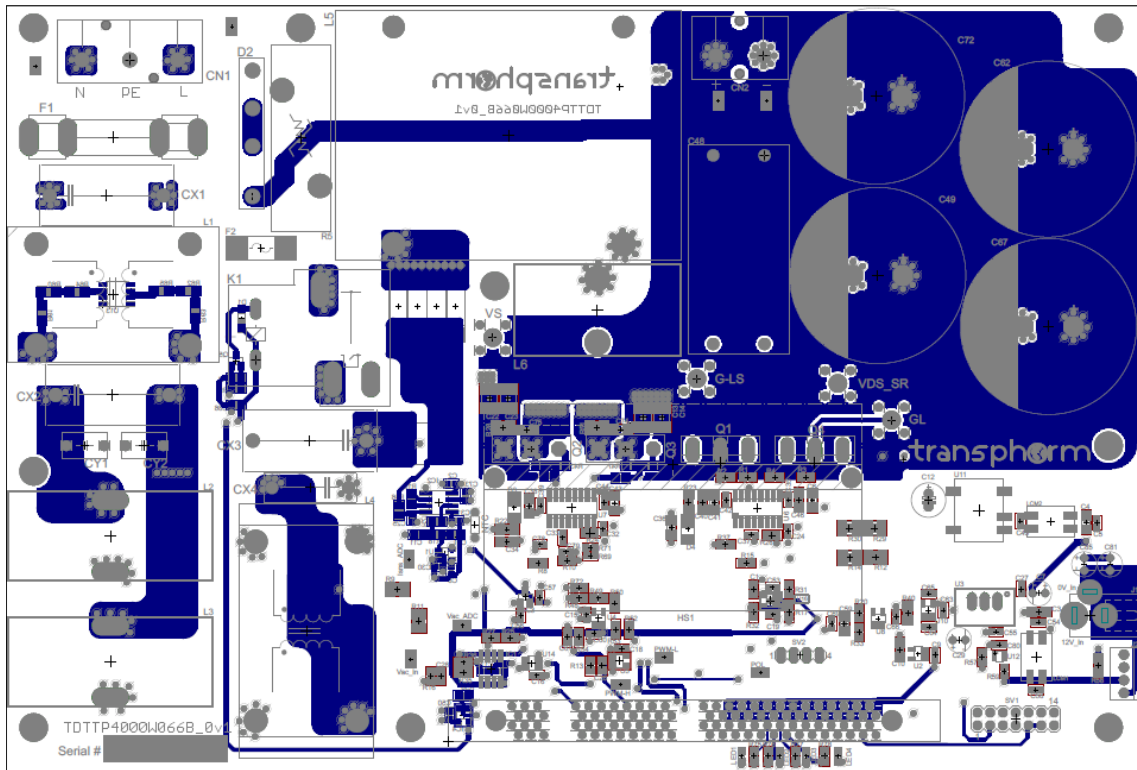

(b) PCB bottom layer

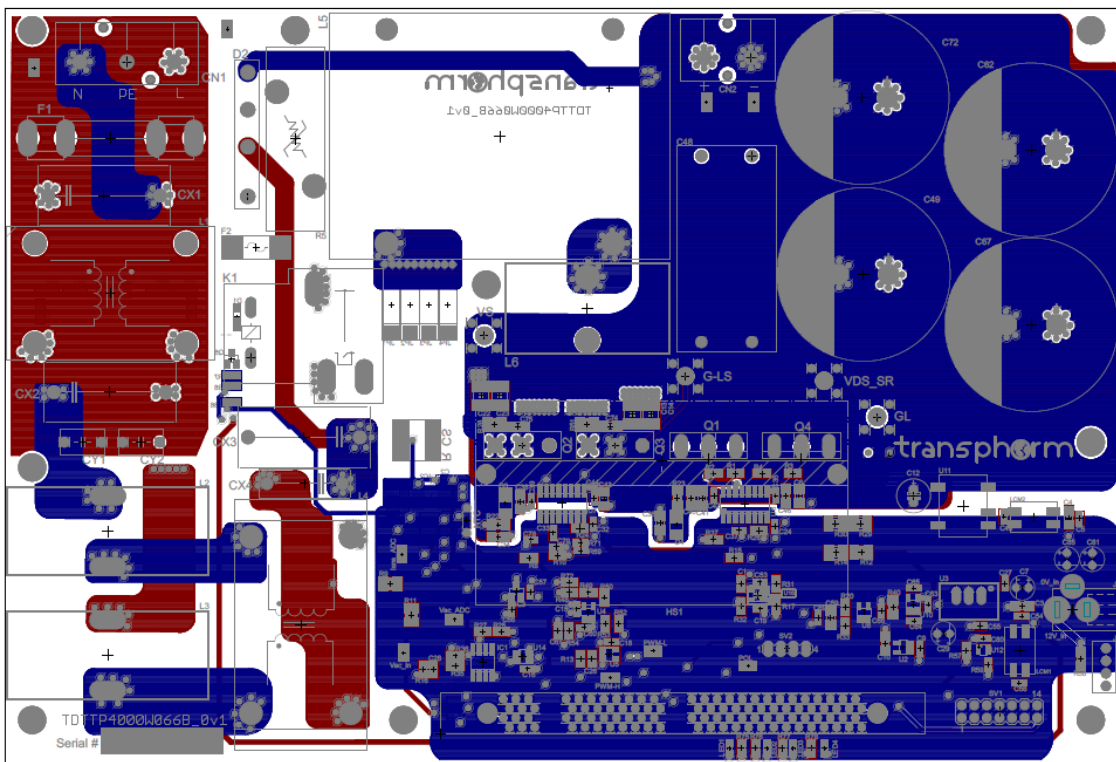

(c) PCB inner layer 2 (ground plane) + inner layer 3 (power plane)

Figure 9. PCB layers

TDTP4000W066B User Guide

Using the board

The TDTP4000W066B board can be used for evaluating Transphorm GaN FETs in a bridgeless totem-pole PFC circuit and is building block but not a complete circuit.

Powering on the board

1. Insert the control card and verify LED1 is on
2. Connect an electronic/resistive load to the corresponding marking (CN2). The requirements for the resistive load are
 - At 115V_{AC} input: 0W and $\leq 2200W$
 - At 230V_{AC} input: 0W and $\leq 4400W$
3. Connect the 12V_{DC} auxiliary supply (included) to the evaluation board
4. Verify that both fans attached to the heatsink are running
5. With high-voltage power off, connect the high-voltage AC power input to the corresponding marking (CN1) on the PCB; N and L (PE: potential ground)
6. Turn on the AC power input (85V_{AC} to 265V_{AC}, 50kHz to 60kHz); minimum power load for turn-on sequence is 350W
7. Monitor CN2 output voltage with V_{DC} meter to verify that 385V \pm 5V is generated
8. Electronic/resistive load can be increased while AC supply is on and board is functional

Powering off the board

1. Switch off the high-voltage AC power input
2. Power off DC bias

Operational waveforms

Figure 10 shows the converter start-up procedure: DC input current (CH1), DC bus voltage waveform (CH2), and voltage waveform of the fast leg switching node (CH3). For the start up, there are three phases to charge the DC bus to a reference voltage.

1. In the beginning the relay K1 is open and DC bus capacitors are charged by input voltage through NTC and diode bridge
2. When the V_{DC} is over 100V, K1 is closed to bypass the NTC and the V_{DC} increases to the peak of the input voltage
3. After 100ms, the leg of the GaN FET is engaged in voltage closed-loop control and the DC bus voltage reference slowly increases to the rated voltage 385V

The NTC and diode bridge are applied in this circuit to avoid high inrush current flow through the GaN FETs.

TDTTP4000W066B User Guide

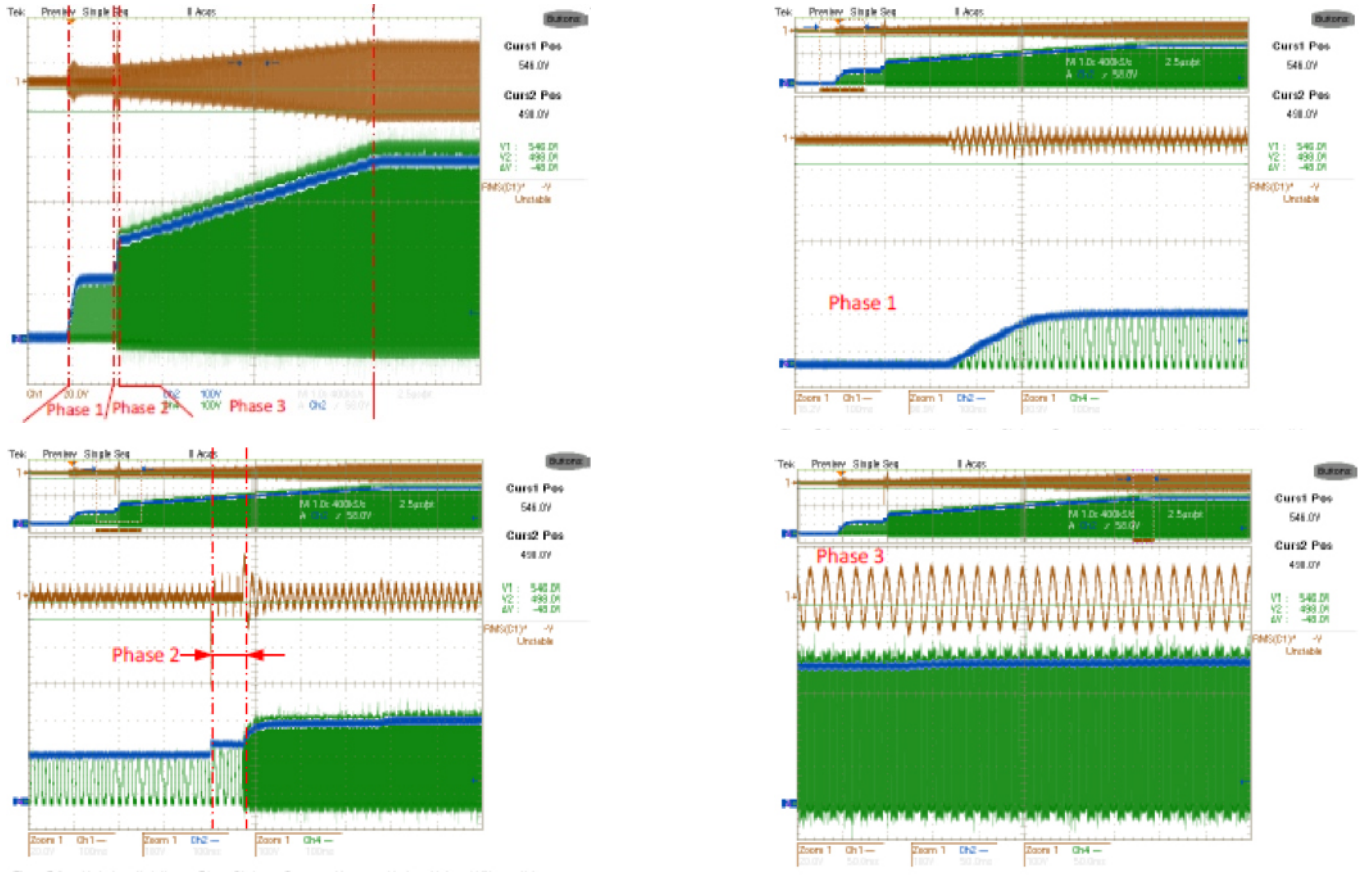

Figure 10. Start-up of the bridgeless totem-pole PFC with 1.2kW load
CH1: i_N , CH2: V_o , CH3: V_{ds}

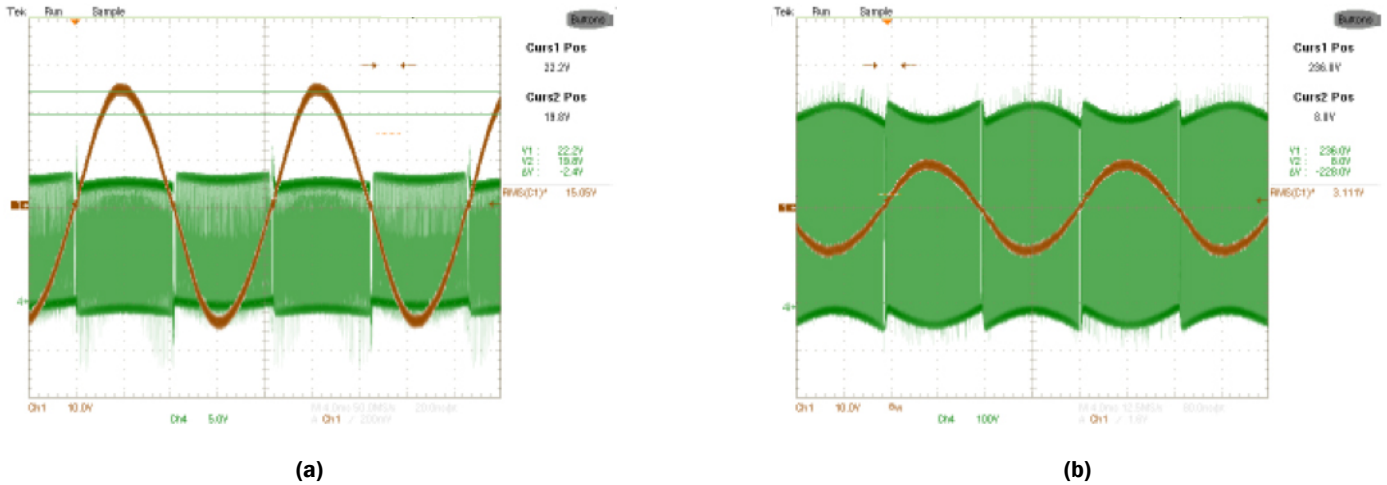
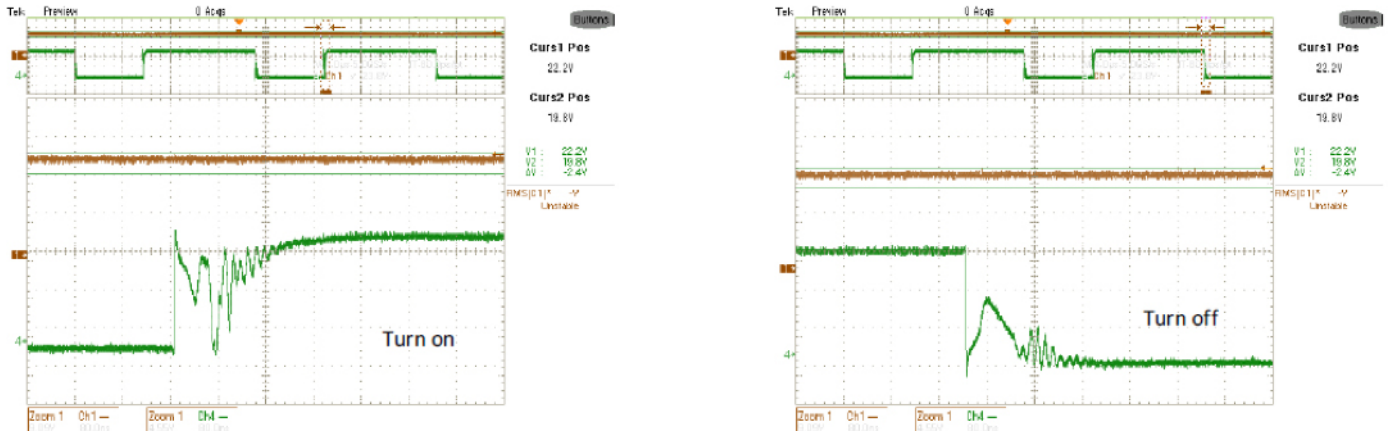

Figure 11. Active switch version of the bridgeless totem-pole PFC at low line, 3.5kW at high line
(a) CH1: $i_N=10A/div$, CH4: V_{ds} of Q2=5V/div and (b) V_{ds} of Q2=100V/div

TDTP4000W066B User Guide

Figure 12 shows the turn-on and turn-off V_{GS} at $I_L=23A$. There is no voltage overshoot at turn-on and the turn-off voltage bump is caused by the R_G . A detailed description of the driver can be found in application note [AN0004: Designing Hard-switched Bridges with GaN](#).



**Figure 12. Waveforms of V_{GS} of Q2 at $I_L=23A$
CH1: $I_L=10A/div$ and CH4: V_{GS} of Q2= $5V/div$**

Figure 13 shows the V_{DS} of Q2 at 3.5kW and a voltage spike of 56V at $I_L=20A$. In this circuit, the RC snubber and R_G help reduce voltage spikes.

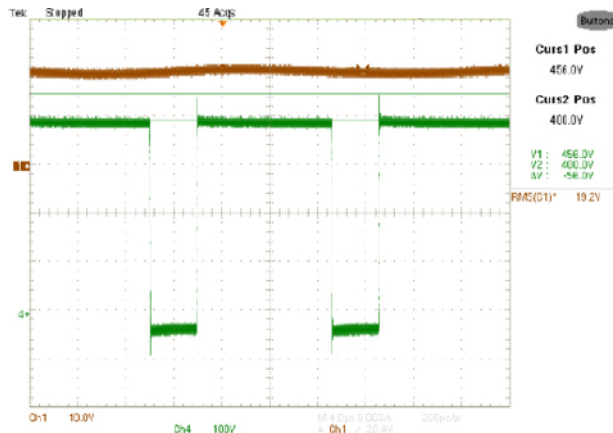

**Figure 13. Waveforms of V_{DS} of Q2 at $I_L=20A$
CH1: $I_L=10A/div$ and CH4: $V_{DS}=100V/div$**

TDTTP4000W066B User Guide

Figure 14 shows the transition between two half-cycles. In Figure 13(a) the AC line enters the negative half and soft-start gradually increases voltage V_D from 0V to 385V, and in Figure 13(b), V_D decreases from 385V to 0V.

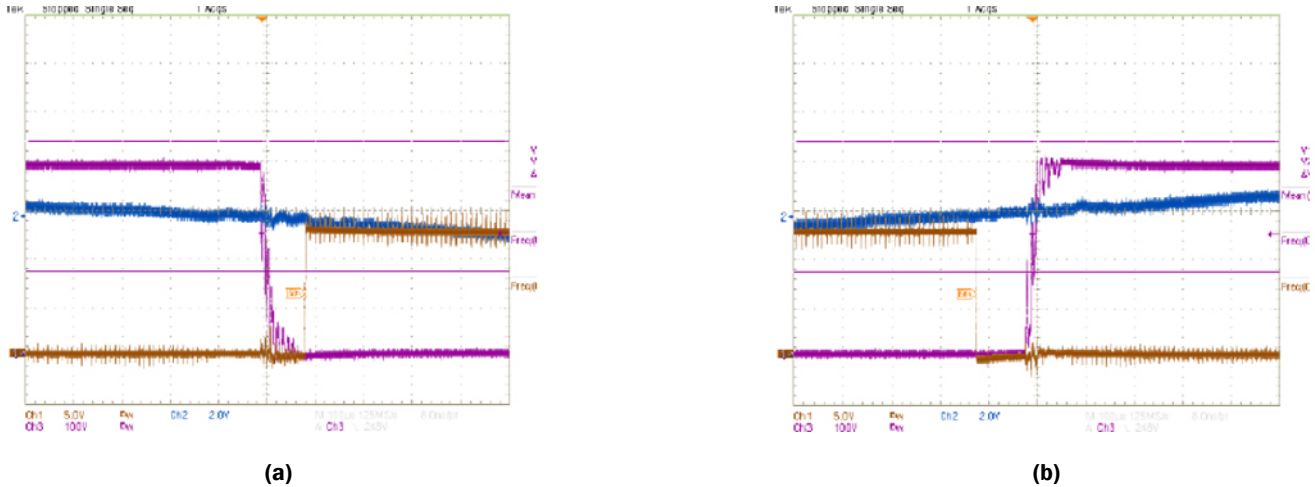

Figure 14. Zero-crossing transitional waveforms (a) from negative to positive half-cycle and (b) from positive to negative half-cycle
CH1: PW< gate signal for S_{D2}, CH2: I_L and CH3: V_D

Probing

As shown in Figure 15, on the evaluation board there are four probing sockets for measuring V_{GS} and V_{DS} of low side GaN FET and MOSFET. By removing the jumpers and using a short wire to clamp the current probe, the PFC inductor can also be measured.

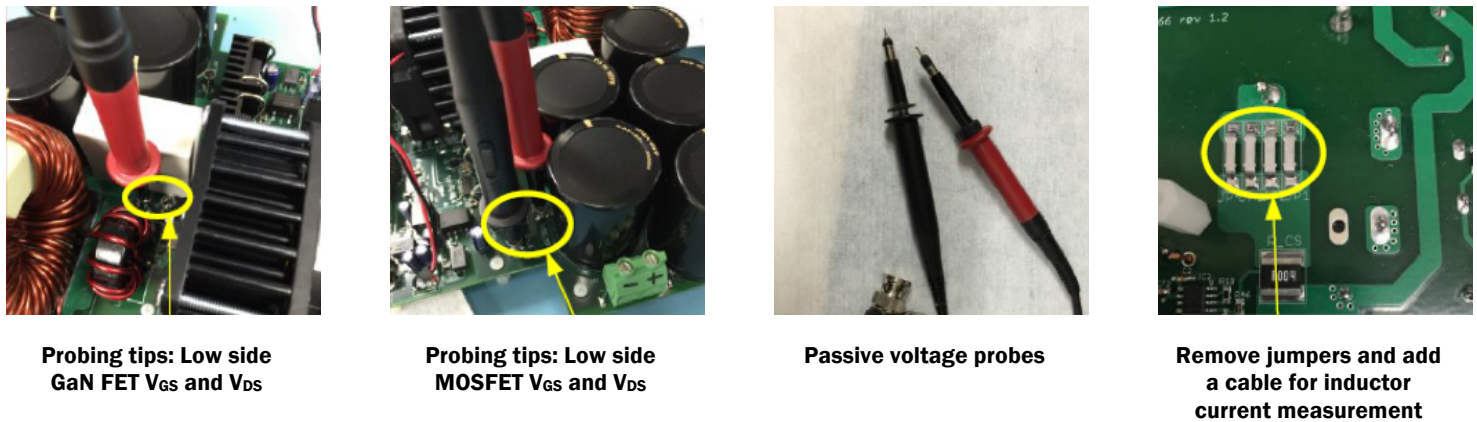

Figure 7. V_{GS} and V_{DS} of low side GaN FET and MOSFET measurement socket tips and current measuring position

Efficiency sweep and EMI

For the efficiency measurement, the input/output voltage and current will be measured for the input/output power calculation with a power analyzer. Efficiency has been measured at 120V_{AC} or 230V_{AC} input and 400V_{DC} output using the WT1800 precision power analyzer from Yokogawa. The efficiency and power loss results for the TDTTP4000W066B are shown in Figure 16. The extremely high efficiency of 99% at 230V_{AC} input, and >98% at 115V AC input is the highest among PFC designs with similar PWM frequency, enabling customers to reach peak system efficiency that meets or exceeds the 80 PLUS standard.

TDTP4000W066B User Guide

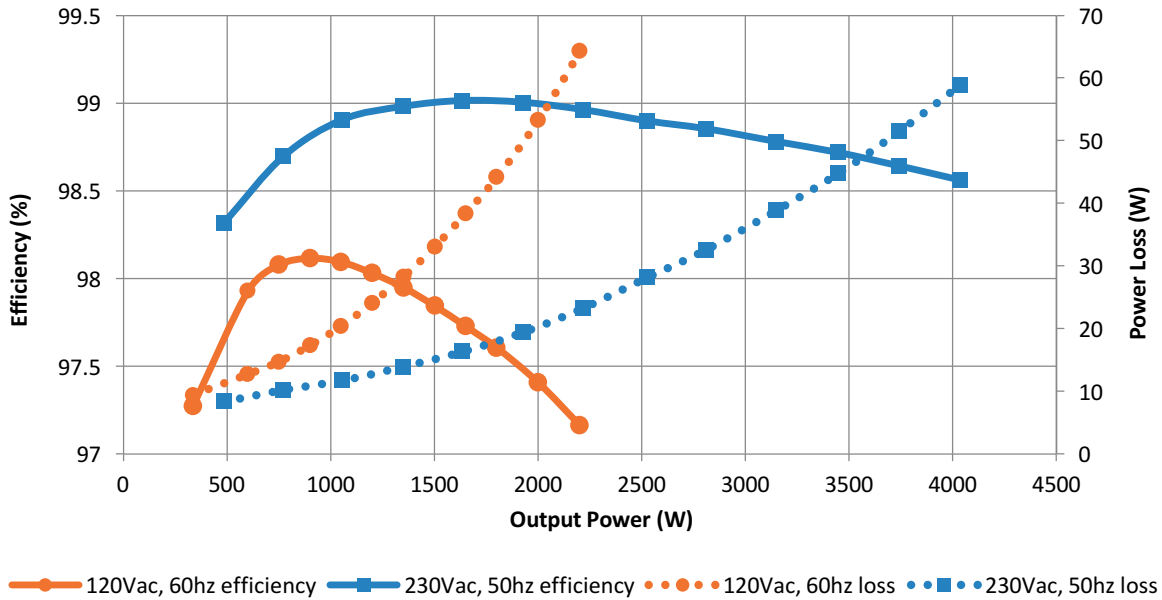

Figure 8. TDTP4000W066B efficiency results

Conducted emissions have also been measured for this board using an LIN-115A LISN by Com-Power. The results compared to EN55022A limits are shown in Figure 17. **Note that the EMI test was done by using the lab-use power supply for an auxiliary 12V source. Do not use wall AC-DC adaptor for EMI test.**

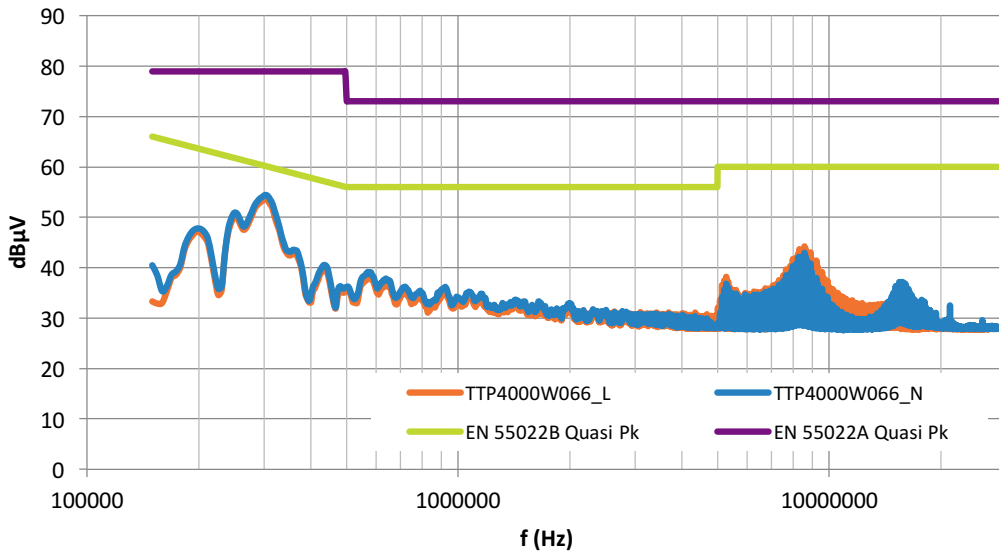

Figure 9. Conducted emissions @ 115V, 1150W

TDTP4000W066B User Guide

The THDi is measured using the WT1800 power analyzer at the condition of input THDv 3.8%, and as shown in Figure 18, it meets the standard of IEC61000-3-12.

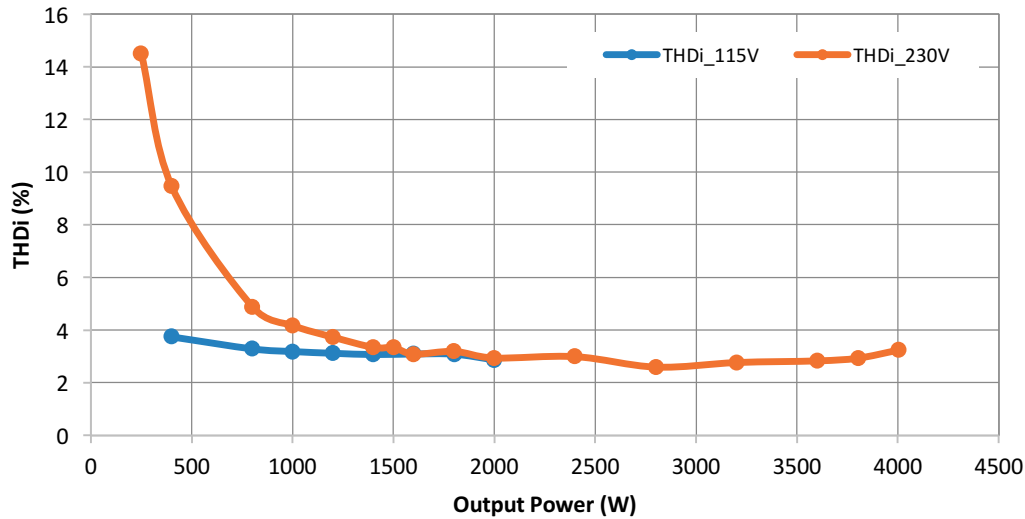

Figure 10. THDi measurements meet IEC61000-3-12 (>16A)

Maximum load limit

The TDTP4000W066B evaluation board can run overload in a short time. The rated input current for $230V_{AC}$ input is 18A and the 10% overload current can be 19.8A. The input over-current protection (OCP) will be triggered when the current is over 21A.

Warnings

The TDTP4000W066B is for evaluation purposes only and is not intended to be a finished product and does not include all protection features found in commercial power supplies. Additional warnings to keep in mind:

1. An isolated AC source should be used as input. An isolated lab bench-grade power supply or the included AUX DC supply should also be used for the 12V DC power supply. Float the oscilloscope by using an isolated oscilloscope or by disabling the PE (Protective Earth) pin in the power plug. Float the current probe power supply (if any) by disabling the PE pin in the power plug.
2. Use a resistive load only. The totem-pole PFC kit can work at zero load with burst mode and the output voltage will be swinging between 375V and 385V during burst mode.
3. The evaluation board is not fully-tested at large load steps. **DO NOT** apply a very large step in the load (>2000W) when it is running.
4. **DO NOT** manually probe the waveforms when the board is running. Set up probing before powering up the demo board.
5. The auxiliary V_{DC} supply must be 12V. The evaluation board will not work under 10V or over 15V V_{DC} , for example.
6. **DO NOT** touch any part of the evaluation board when it is running.
7. When plugging the control cards into the socket, make sure the control cards are fully pushed down with a clicking sound.
8. If the evaluation circuit goes into protection mode it will work as a diode bridge by shutting down all PWM functions. Recycle the bias power supply to reset the DSP and exit protection mode.
9. **DO NOT** use a passive probe to measure control circuit signals and power circuit signals at the same time. GND1 and AGND are not the same ground.
10. To get clean V_{GS} of the low side GaN FET, it is not recommended to measure the V_{DS} at the same time.
11. It is not recommended to use a passive voltage probe for V_{DS} and V_{GS} measurements while simultaneously using a differential voltage probe for V_{IN} measurements, unless the differential probe has very good dv/dt immunity.

References

- [1] Z. Liang, U. Mishra and Y. Wu, "True Bridge-less Totem-pole PFC based on GaN FETs," in *PCIM*, Europe, pp. 1017-1022, May 2013.



Компания «ЭлектроПласт» предлагает заключение долгосрочных отношений при поставках импортных электронных компонентов на взаимовыгодных условиях!

Наши преимущества:

- Оперативные поставки широкого спектра электронных компонентов отечественного и импортного производства напрямую от производителей и с крупнейших мировых складов;
- Поставка более 17-ти миллионов наименований электронных компонентов;
- Поставка сложных, дефицитных, либо снятых с производства позиций;
- Оперативные сроки поставки под заказ (от 5 рабочих дней);
- Экспресс доставка в любую точку России;
- Техническая поддержка проекта, помощь в подборе аналогов, поставка прототипов;
- Система менеджмента качества сертифицирована по Международному стандарту ISO 9001;
- Лицензия ФСБ на осуществление работ с использованием сведений, составляющих государственную тайну;
- Поставка специализированных компонентов (Xilinx, Altera, Analog Devices, Intersil, Interpoint, Microsemi, Aeroflex, Peregrine, Syfer, Eurofarad, Texas Instrument, Miteq, Cobham, E2V, MA-COM, Hittite, Mini-Circuits, General Dynamics и др.);

Помимо этого, одним из направлений компании «ЭлектроПласт» является направление «Источники питания». Мы предлагаем Вам помощь Конструкторского отдела:

- Подбор оптимального решения, техническое обоснование при выборе компонента;
- Подбор аналогов;
- Консультации по применению компонента;
- Поставка образцов и прототипов;
- Техническая поддержка проекта;
- Защита от снятия компонента с производства.



Как с нами связаться

Телефон: 8 (812) 309 58 32 (многоканальный)

Факс: 8 (812) 320-02-42

Электронная почта: org@eplast1.ru

Адрес: 198099, г. Санкт-Петербург, ул. Калинина, дом 2, корпус 4, литера А.