

CMOS 4-BIT SINGLE CHIP MICROCOMPUTER
S5U1C63000P Manual
(S1C63 Family Peripheral Circuit Board)

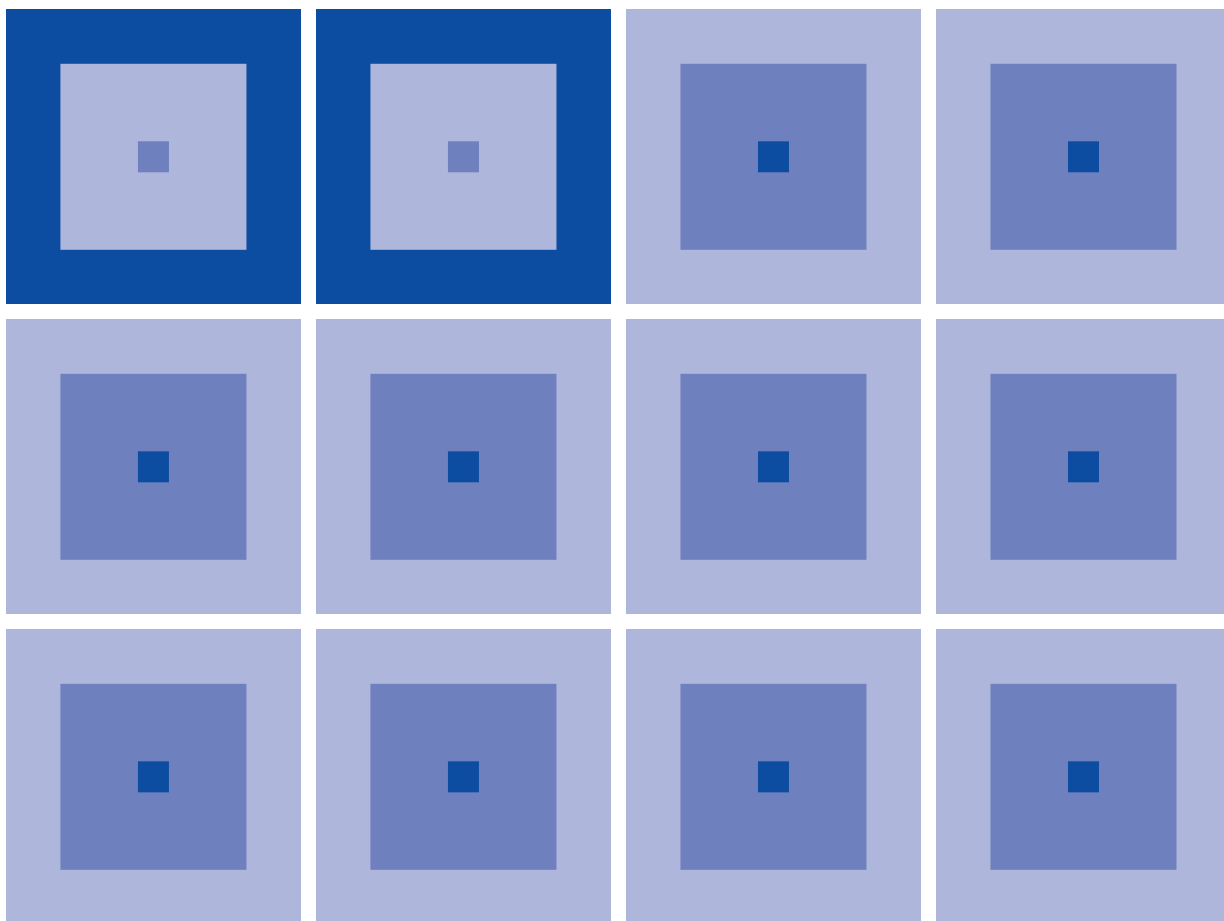

NOTICE

No part of this material may be reproduced or duplicated in any form or by any means without the written permission of Seiko Epson. Seiko Epson reserves the right to make changes to this material without notice. Seiko Epson does not assume any liability of any kind arising out of any inaccuracies contained in this material or due to its application or use in any product or circuit and, further, there is no representation that this material is applicable to products requiring high level reliability, such as medical products. Moreover, no license to any intellectual property rights is granted by implication or otherwise, and there is no representation or warranty that anything made in accordance with this material will be free from any patent or copyright infringement of a third party. This material or portions thereof may contain technology or the subject relating to strategic products under the control of the Foreign Exchange and Foreign Trade Law of Japan and may require an export license from the Ministry of International Trade and Industry or other approval from another government agency.

MS-DOS, Windows, Windows 95, Windows 98 and Windows NT are registered trademarks of Microsoft Corporation, U.S.A.
PC-DOS, PC/AT, PS/2, VGA, EGA and IBM are registered trademarks of International Business Machines Corporation, U.S.A.
NEC PC-9800 Series and NEC are registered trademarks of NEC Corporation.
All other product names mentioned herein are trademarks and/or registered trademarks of their respective owners.

New configuration of product number

Starting April 1, 2001, the configuration of product number descriptions will be changed as listed below. To order from April 1, 2001 please use these product numbers. For further information, please contact Epson sales representative.

Devices

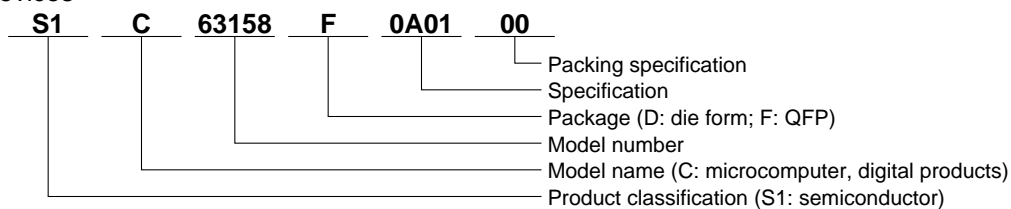

Development tools

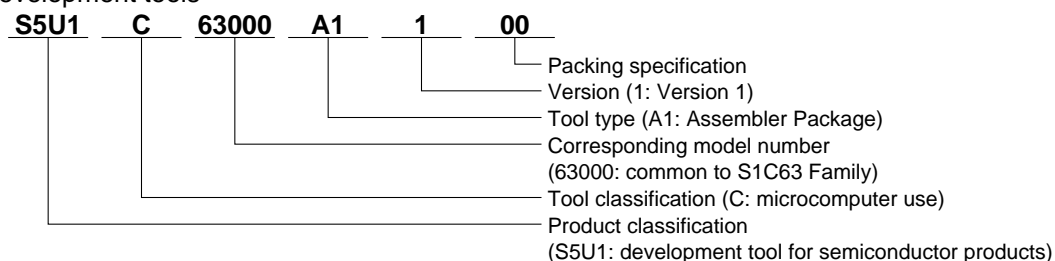

S5U1C63000P Manual (S1C63 Family Peripheral Circuit Board)

This manual describes how to use the S1C63 Family Peripheral Circuit Board (S5U1C63000P). This circuit board is used to provide emulation functions when it is installed in the ICE (S5U1C63000H1/S5U1C63000H2), a debugging tool for the 4-bit Single Chip Microcomputer S1C63 Family. This manual describes only the common specifications of the S1C63 Family Peripheral Circuit Board (S5U1C63000P), so refer to the S5U1C63000P Manual (Peripheral Circuit Board for S1C63xxx) for the model dependent specifications. For details on ICE functions and how to operate the debugger, refer to the separately prepared manuals.

Contents

CHAPTER 1	<i>INTRODUCTION</i>	<i>1</i>
1.1	<i>Outline of S5U1C63000P</i>	<i>1</i>
1.2	<i>Components of S5U1C63000P</i>	<i>1</i>
1.3	<i>External View of S5U1C63000P</i>	<i>1</i>
CHAPTER 2	<i>SETTING UP THE S5U1C63000P</i>	<i>2</i>
2.1	<i>Installing the S5U1C63000P in the ICE (S5U1C63000H1/S5U1C63000H2)</i>	<i>2</i>
2.2	<i>Downloading Cricuit Data 1 – when new ICE (S5U1C63000H2) is used</i>	<i>3</i>
2.3	<i>Downloading Cricuit Data 2 – when previous ICE (S5U1C63000H1) is used</i>	<i>3</i>
CHAPTER 3	<i>PRODUCT SPECIFICATIONS</i>	<i>4</i>

CHAPTER 1 INTRODUCTION

1.1 Outline of S5U1C63000P

The S5U1C63000P provides on a board all the peripheral circuits of S1C63 Family microcomputers other than the core CPU. By installing this board in the ICE (S5U1C63000H1/S5U1C63000H2) you can use it to emulate each model in the S1C63 Family. This board contains a programmable gate array (FPGA) and supports each model by downloading the circuit data from the host PC to the FPGA via the ICE.

1.2 Components of S5U1C63000P

After unpacking your S5U1C63000P package, check to see that all of the following components are included.

- (1) S5U1C63000P main unit 1 board
- (2) I/O cable (80-pin/40-pin × 2 flat type) 1 pair
- (3) I/O cable (100-pin/50-pin × 2 flat type) 1 pair
- (4) Connector for connecting to target system (40-pin) 2 pieces
- (5) Connector for connecting to target system (50-pin) 2 pieces
- (6) Warranty card 1 card
- (7) User registration card 1 card
- (8) Precautions on Using the S5U1C63000P Peripheral Circuit Board 1 sheet
- (9) S5U1C63000P Manual (S1C63 Family Peripheral Circuit Board) 1 copy

1.3 External View of S5U1C63000P

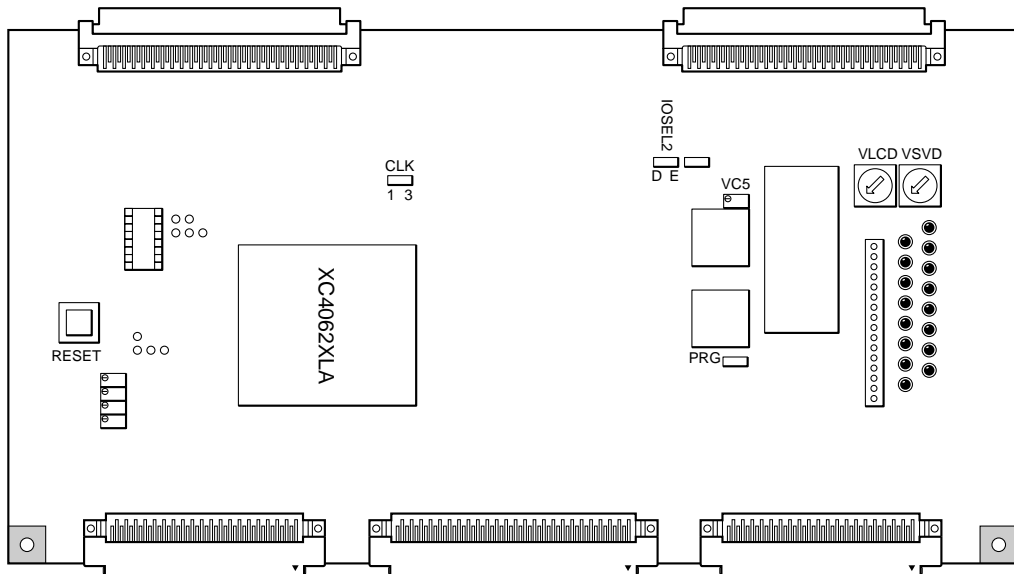

Fig. 1.3.1 External view of S5U1C63000P

CHAPTER 2 SETTING UP THE S5U1C63000P

2.1 Installing the S5U1C63000P in the ICE (S5U1C63000H1/S5U1C63000H2)

- (1) Unfasten the screws located on the left and right sides of the front panel of the ICE (S5U1C63000H1/S5U1C63000H2) by turning them counterclockwise, then remove the front panel.
- (2) Insert the S5U1C63000P board into the ICE along its uppermost guide rails until the tip of the board touches the back of the ICE. If some other board is mounted on the uppermost guide rails, remove that board by using the jig supplied with the ICE before you insert the S5U1C63000P board (see Figure 2.1.3).
- (3) Once the S5U1C63000P board has been inserted almost fully into the ICE, secure it in position by using the jig supplied with the ICE (see Figure 2.1.2).
- (4) When the above is done, replace the front panel.

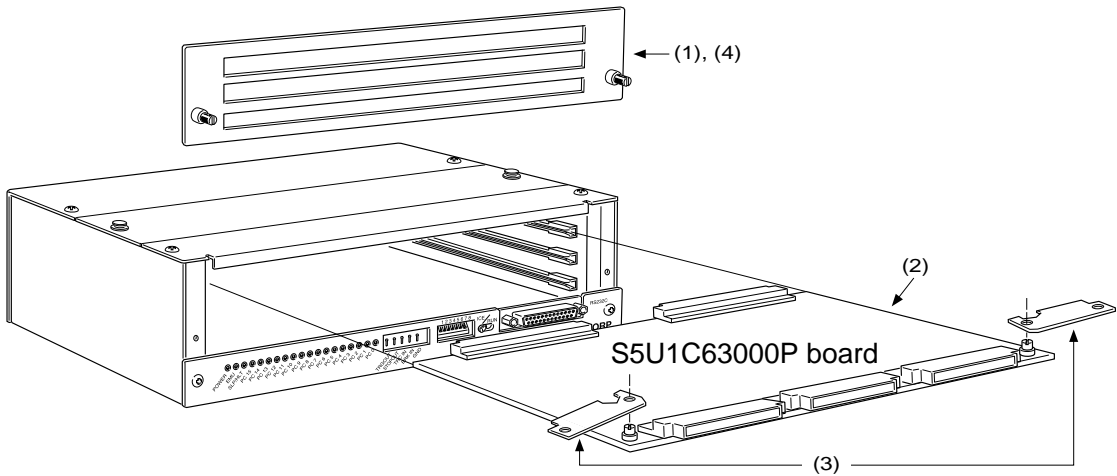

Fig. 2.1.1 Installing the S5U1C63000P board in the ICE (S5U1C63000H1/S5U1C63000H2)

• Installing the S5U1C63000P board

Set the jig included with the ICE into position as shown in Figure 2.1.2. Using this jig as a lever, push it toward the inside of the board evenly on the left and right sides. After confirming that the S5U1C63000P board has been firmly fitted into the internal slot of the ICE, remove the jig.

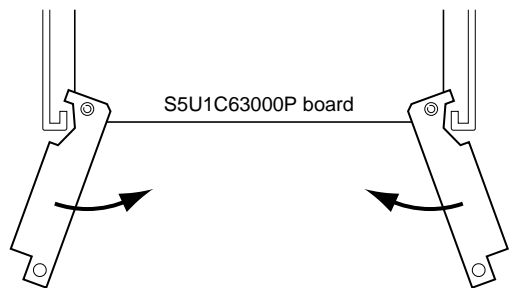

Fig. 2.1.2

Installing the S5U1C63000P board

• Dismounting the S5U1C63000P board

Set the jig included with the ICE into position as shown in Figure 2.1.3. Using this jig as a lever, push it toward the outside of the board evenly on the left and right sides. After confirming that the S5U1C63000P board has been dismantled from the backboard connector, pull the S5U1C63000P board out of the ICE.

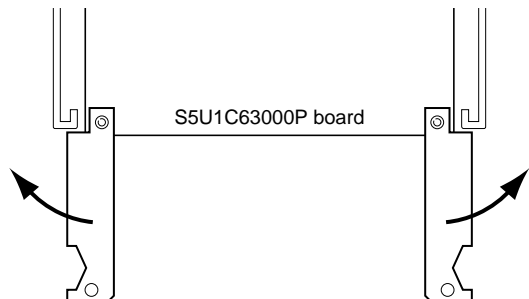

Fig. 2.1.3

Dismounting the S5U1C63000P board

2.2 Downloading Circuit Data 1 – when new ICE (S5U1C63000H2) is used

This board (S5U1C63000P) comes with the FPGA that contains factory inspection data, therefore the circuit data for the model to be used should be downloaded. The following explains the downloading procedure.

- 1) Remove the ICE top cover and then set the DIP switch "IOSEL2" on this board to the "E" position.
- 2) Connect the ICE to the host PC. Then turn the host PC and ICE on.
- 3) Invoke the debugger included in the assembler package (ver. 5 or later). For how to use the ICE and debugger, refer to the manuals supplied with the ICE and assembler package.
- 4) Download the circuit data file (.mot) corresponding to the model by entering the following commands in the command window.

```
>XFER                                (erase all)
>XFWR <file name>                    (download the specified file)*
>XFCP <file name>                    (compare the specified file and downloaded data)
```

* The downloading takes about 15 minutes.

- 5) Terminate the debugger and then turn the ICE off.
- 6) Set the DIP switch "IOSEL2" on this board to the "D" position.
- 7) Turn the ICE on and invoke the debugger again. Debugging can be started here.

2.3 Downloading Circuit Data 2 – when previous ICE (S5U1C63000H1) is used

The standard ICE (S5U1C63000H1, previous model) did not support the circuit data download function for this board. To use the download function, update the ICE firmware according to the following procedure.

- 1) Set the baud rate of the ICE to 9600 bps. Refer to the manual supplied with the ICE for setting the DIP switch.
- 2) Connect the ICE to the host PC and then start up the host PC in DOS. When Windows is running, restart in DOS mode.

Note: Do not use the DOS prompt of Windows.

- 3) Turn the ICE on.
- 4) Configure the RS232C parameters for the host PC as follows:

```
C:\>MODE COM1:9600,n,8,1,p (9600 bps, 8-bit data, 1 stop bit, no parity)
```

- 5) Copy the following files included in the assembler package (ver. 5 or later) to a directory on the hard disk.
- ```
tm63.exe, ice63.com, i63com.o, i63par
```
- 6) Move to the directory in Step 5, run the TM63. TM63 enters command ready status after invocation, enter a command as follows:

```
C:\>tm63 xat
TM63 start on IBM PC
TM63 start V01.01
>dlf ice63.com i63com.o i63par 0b
...
>q
```

- 7) Enter "q" to terminate TM63 after the prompt mark is displayed.
- 8) The ICE firmware is now updated. Turn the ICE off and then download the circuit data by the procedure described in Section 2.2.

# CHAPTER 3 *PRODUCT SPECIFICATIONS*

The specifications of the S5U1C63000P are listed below.

## **S5U1C63000P**

Dimension: 254 mm (wide) × 144.8 mm (depth) × 13 mm (height) (including screws)  
 Weight: Approx. 300 g  
 Power supply: DC 5 V ± 5%, less than 1 A (supplied from ICE main unit)

### **I/O connection cable (80-pin)**

S5U1C63000P connector: KEL8830E-080-170L  
 Cable connector (80-pin): KEL8822E-080-171  
 Cable connector (40-pin): 3M7940-6500SC 1 pair  
 Cable: 40-pin flat cable 1 pair  
 Interface: CMOS interface (3.3 V)  
 Length: Approx. 40 cm

### **I/O connection cable (100-pin)**

S5U1C63000P connector: KEL8830E-100-170L  
 Cable connector (100-pin): KEL8822E-100-171  
 Cable connector (50-pin): 3M7950-6500SC 1 pair  
 Cable: 50-pin flat cable 1 pair  
 Interface: CMOS interface (3.3 V)  
 Length: Approx. 40 cm

### **Accessories**

40-pin connector for connecting to target system:  
 3M3432-6002LCSC × 2  
 50-pin connector for connecting to target system:  
 3M3433-6002LCSC × 2

# EPSON International Sales Operations

---

## AMERICA

---

### EPSON ELECTRONICS AMERICA, INC.

#### - HEADQUARTERS -

150 River Oaks Parkway  
San Jose, CA 95134, U.S.A.  
Phone: +1-408-922-0200 Fax: +1-408-922-0238

#### - SALES OFFICES -

##### West

1960 E. Grand Avenue  
El Segundo, CA 90245, U.S.A.  
Phone: +1-310-955-5300 Fax: +1-310-955-5400

##### Central

101 Virginia Street, Suite 290  
Crystal Lake, IL 60014, U.S.A.  
Phone: +1-815-455-7630 Fax: +1-815-455-7633

##### Northeast

301 Edgewater Place, Suite 120  
Wakefield, MA 01880, U.S.A.  
Phone: +1-781-246-3600 Fax: +1-781-246-5443

##### Southeast

3010 Royal Blvd. South, Suite 170  
Alpharetta, GA 30005, U.S.A.  
Phone: +1-877-EEA-0020 Fax: +1-770-777-2637

## EUROPE

---

### EPSON EUROPE ELECTRONICS GmbH

#### - HEADQUARTERS -

Riesstrasse 15  
80992 Munich, GERMANY  
Phone: +49-(0)89-14005-0 Fax: +49-(0)89-14005-110

#### SALES OFFICE

Altstadtstrasse 176  
51379 Leverkusen, GERMANY  
Phone: +49-(0)2171-5045-0 Fax: +49-(0)2171-5045-10

#### UK BRANCH OFFICE

Unit 2.4, Doncastle House, Doncastle Road  
Bracknell, Berkshire RG12 8PE, ENGLAND  
Phone: +44-(0)1344-381700 Fax: +44-(0)1344-381701

#### FRENCH BRANCH OFFICE

1 Avenue de l'Atlantique, LP 915 Les Conquerants  
Z.A. de Courtaboeuf 2, F-91976 Les Ulis Cedex, FRANCE  
Phone: +33-(0)1-64862350 Fax: +33-(0)1-64862355

#### BARCELONA BRANCH OFFICE

##### Barcelona Design Center

Edificio Testa, Avda. Alcalde Barrils num. 64-68  
E-08190 Sant Cugat del Vallès, SPAIN  
Phone: +34-93-544-2490 Fax: +34-93-544-2491

## ASIA

---

### EPSON (CHINA) CO., LTD.

23F, Beijing Silver Tower 2# North RD DongSanHuan  
ChaoYang District, Beijing, CHINA  
Phone: 64106655 Fax: 64107319

#### SHANGHAI BRANCH

4F, Bldg., 27, No. 69, Gui Jing Road  
Caohejing, Shanghai, CHINA  
Phone: 21-6485-5552 Fax: 21-6485-0775

### EPSON HONG KONG LTD.

20/F., Harbour Centre, 25 Harbour Road  
Wanchai, Hong Kong  
Phone: +852-2585-4600 Fax: +852-2827-4346  
Telex: 65542 EPSCO HX

### EPSON TAIWAN TECHNOLOGY & TRADING LTD.

10F, No. 287, Nanking East Road, Sec. 3  
Taipei  
Phone: 02-2717-7360 Fax: 02-2712-9164  
Telex: 24444 EPSONTB

#### HSINCHU OFFICE

13F-3, No. 295, Kuang-Fu Road, Sec. 2  
HsinChu 300  
Phone: 03-573-9900 Fax: 03-573-9169

### EPSON SINGAPORE PTE., LTD.

No. 1 Temasek Avenue, #36-00  
Millenia Tower, SINGAPORE 039192  
Phone: +65-337-7911 Fax: +65-334-2716

### SEIKO EPSON CORPORATION KOREA OFFICE

50F, KLI 63 Bldg., 60 Yoido-dong  
Youngdeungpo-Ku, Seoul, 150-763, KOREA  
Phone: 02-784-6027 Fax: 02-767-3677

### SEIKO EPSON CORPORATION

#### ELECTRONIC DEVICES MARKETING DIVISION

##### Electronic Device Marketing Department

##### IC Marketing & Engineering Group

421-8, Hino, Hino-shi, Tokyo 191-8501, JAPAN  
Phone: +81-(0)42-587-5816 Fax: +81-(0)42-587-5624

##### ED International Marketing Department Europe & U.S.A.

421-8, Hino, Hino-shi, Tokyo 191-8501, JAPAN  
Phone: +81-(0)42-587-5812 Fax: +81-(0)42-587-5564

##### ED International Marketing Department Asia

421-8, Hino, Hino-shi, Tokyo 191-8501, JAPAN  
Phone: +81-(0)42-587-5814 Fax: +81-(0)42-587-5110

**S5U1C63000P** Manual  
(S1C63 Family Peripheral Circuit Board)

**SEIKO EPSON CORPORATION**  
ELECTRONIC DEVICES MARKETING DIVISION

■ EPSON Electronic Devices Website

<http://www.epson.co.jp/device/>

# Mouser Electronics

Authorized Distributor

Click to View Pricing, Inventory, Delivery & Lifecycle Information:

Epson:

[S5U1C63000P6100](#)



Компания «ЭлектроПласт» предлагает заключение долгосрочных отношений при поставках импортных электронных компонентов на взаимовыгодных условиях!

Наши преимущества:

- Оперативные поставки широкого спектра электронных компонентов отечественного и импортного производства напрямую от производителей и с крупнейших мировых складов;
- Поставка более 17-ти миллионов наименований электронных компонентов;
- Поставка сложных, дефицитных, либо снятых с производства позиций;
- Оперативные сроки поставки под заказ (от 5 рабочих дней);
- Экспресс доставка в любую точку России;
- Техническая поддержка проекта, помощь в подборе аналогов, поставка прототипов;
- Система менеджмента качества сертифицирована по Международному стандарту ISO 9001;
- Лицензия ФСБ на осуществление работ с использованием сведений, составляющих государственную тайну;
- Поставка специализированных компонентов (Xilinx, Altera, Analog Devices, Intersil, Interpoint, Microsemi, Aeroflex, Peregrine, Syfer, Eurofarad, Texas Instrument, Miteq, Cobham, E2V, MA-COM, Hittite, Mini-Circuits, General Dynamics и др.);

Помимо этого, одним из направлений компании «ЭлектроПласт» является направление «Источники питания». Мы предлагаем Вам помощь Конструкторского отдела:

- Подбор оптимального решения, техническое обоснование при выборе компонента;
- Подбор аналогов;
- Консультации по применению компонента;
- Поставка образцов и прототипов;
- Техническая поддержка проекта;
- Защита от снятия компонента с производства.



#### Как с нами связаться

**Телефон:** 8 (812) 309 58 32 (многоканальный)

**Факс:** 8 (812) 320-02-42

**Электронная почта:** [org@eplast1.ru](mailto:org@eplast1.ru)

**Адрес:** 198099, г. Санкт-Петербург, ул. Калинина, дом 2, корпус 4, литера А.