



### Typical Applications

The HMC709LC5 is ideal for:

- Point-to-Point and Point-to-Multi-Point Radio
- Military Radar, EW & ELINT
- Ku Band VSAT Upconverters
- Sensors
- Test & Measurement Equipment

### Features

- High Conversion Gain: 13 dB
- Sideband Rejection: -20 dB
- LO to RF Isolation: 10 dB
- Output IP3: +26 dBm
- RoHS Compliant 5x5 mm Ceramic SMT Package

### Functional Diagram

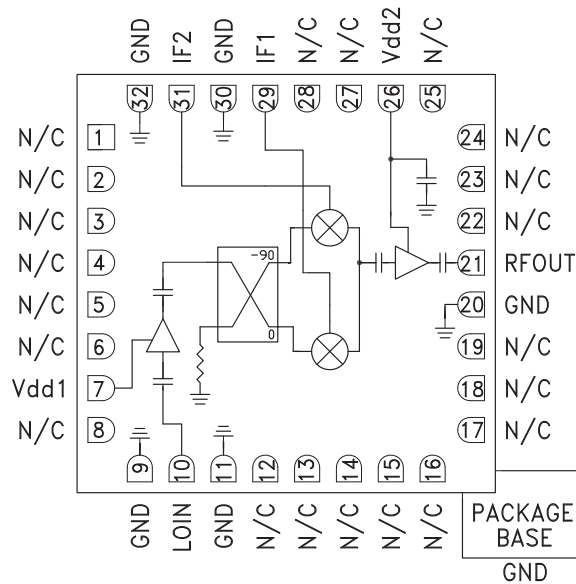

### General Description

The HMC709LC5 is a compact GaAs MMIC I/Q upconverter in a leadless RoHS compliant SMT package. This device provides a small signal conversion gain of 13 dB with -20 dB of sideband rejection. The HMC709LC5 utilizes a driver amplifier preceded by an I/Q mixer which is driven by an LO buffer amplifier. IF1 and IF2 mixer inputs are provided and an external 90° hybrid is needed to select the required sideband. The I/Q mixer topology reduces the need for filtering of the unwanted sideband. The HMC709LC5 is a much smaller alternative to hybrid style single sideband upconverter assemblies and it eliminates the need for wire bonding by allowing the use of surface mount manufacturing techniques.

### Electrical Specifications,

$T_A = +25^\circ C$ ,  $IF = 1000 MHz$ ,  $LO = +6 dBm$ ,  $Vdd1, 2 = +5V$  [1]

Parameter	Min.	Typ.	Max.	Units
Frequency Range, RF		11 - 17		GHz
Frequency Range, LO		10 - 18		GHz
Frequency Range, IF		DC - 3.75		GHz
Conversion Gain	10	13		dB
Sideband Rejection	-12	-20		dB
1 dB Compression (Output)		20.5		dBm
LO to RF Isolation		10		dB
LO to IF Isolation [2]		15		dB
IP3 (Output)		26		dBm
Supply Current Idd1	68	105	115	mA
Supply Current Idd2	80	127	150	mA

[1] Unless otherwise noted all measurements performed with high side LO, IF= 1000 MHz and external 90° IF hybrid.

[2] Data taken without external IF Hybrid

#### Data Taken as SSB Upconverter with External IF Hybrid

**Conversion Gain vs. Temperature**

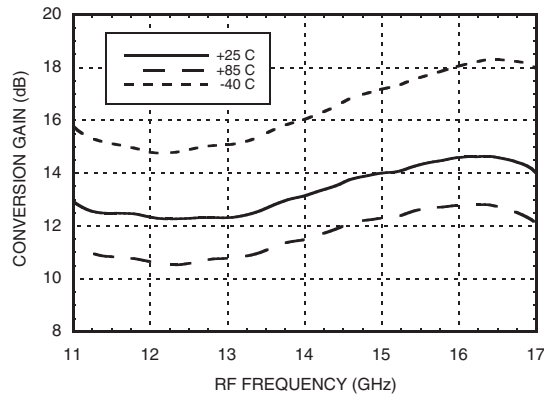

**Conversion Gain vs. LO Drive**

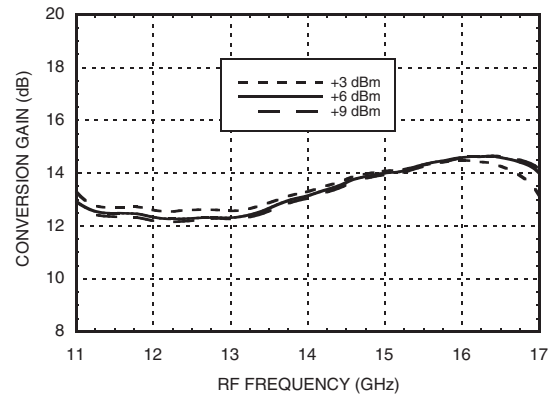

**Conversion Gain vs. IF Frequency**

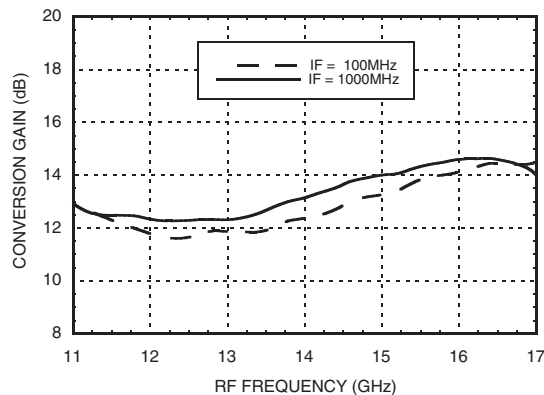

**Side Band Rejection**

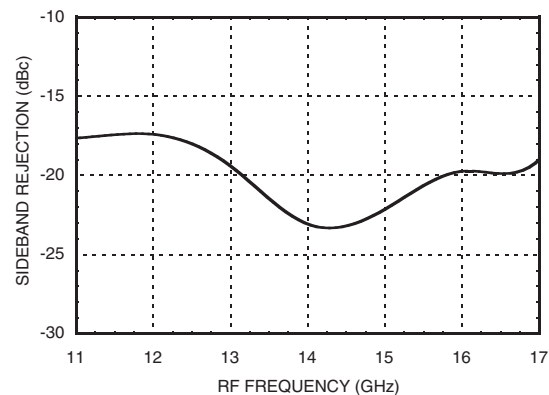

**RF, LO Return Loss [1]**

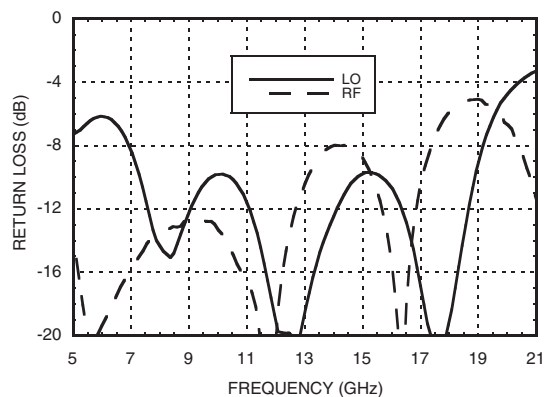

**IF Return Loss [1]**

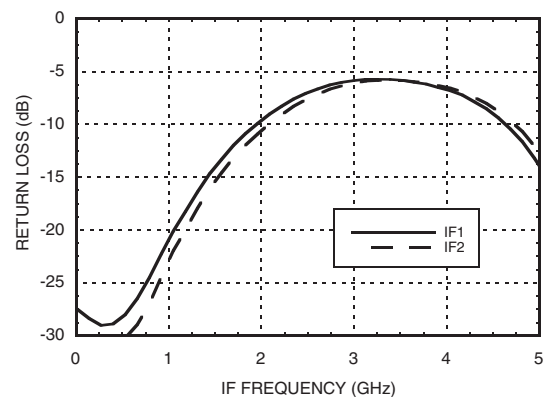

[1] Data taken without external IF hybrid



Data Taken as SSB Upconverter with External IF Hybrid

### Output P1dB vs. Temperature

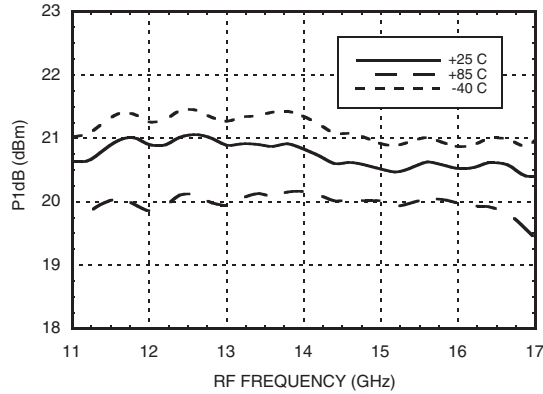

### Isolations <sup>[1]</sup>

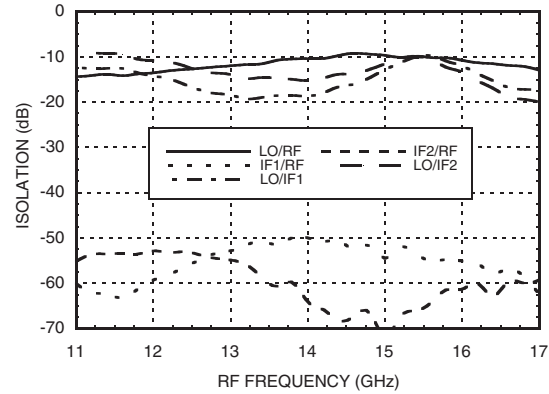

### Output IP3 vs. Temperature <sup>[2]</sup>

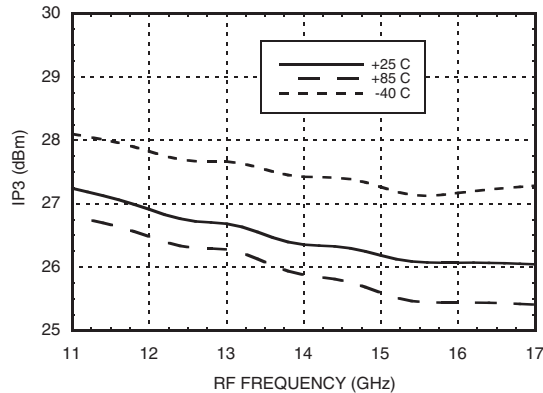

### Output IP3 vs. LO Drive <sup>[2]</sup>

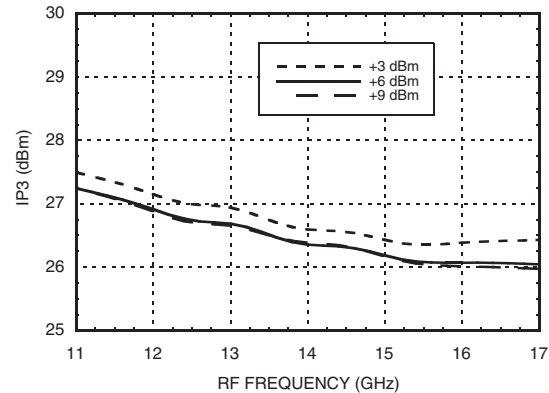

### MxN Spurious Outputs <sup>[1]</sup>

mIF	nLO				
	0	1	2	3	4
0	xx	6	37	46	xx
1	62	0	45	65	xx
2	39	47	50	72	xx
3	74	50	73	77	xx
4	68	91	76	94	xx

IF = 1 GHz @ -8 dBm  
LO = 14 GHz @ 6 dBm  
Data taken without IF hybrid  
All values in dBc below RF power level (-1IF + 1LO)

### Harmonics of LO

LO Freq. (GHz)	nLO Spur @ IF Port			
	1	2	3	4
12	16	23	58	xx
13	15	31	50	xx
14	13	50	51	xx
15	10	37	xx	xx
16	10	44	xx	xx
17	11	54	xx	xx
18	14	68	xx	xx
19	16	51	xx	xx

[1] Data taken without external IF hybrid  
[2] Two tone input power = -8 dBm, 1 MHz spacing

### Absolute Maximum Ratings

Drain Bias Voltage (Vdd1, 2)	5.5V
IF Input Power (IF1, IF2)	20 dBm
LO Drive (LO IN)	20 dBm
Channel Temperature	175°C
Continuous P <sub>diss</sub> (T = 85°C) (derate 18.3 mW/°C above 85°C)	1.65 mW
Thermal Resistance (channel to ground paddle)	54.6 °C/W
Storage Temperature	-65 to +150 °C
Operating Temperature	-55 to +85 °C



ELECTROSTATIC SENSITIVE DEVICE  
OBSERVE HANDLING PRECAUTIONS

8

### Outline Drawing

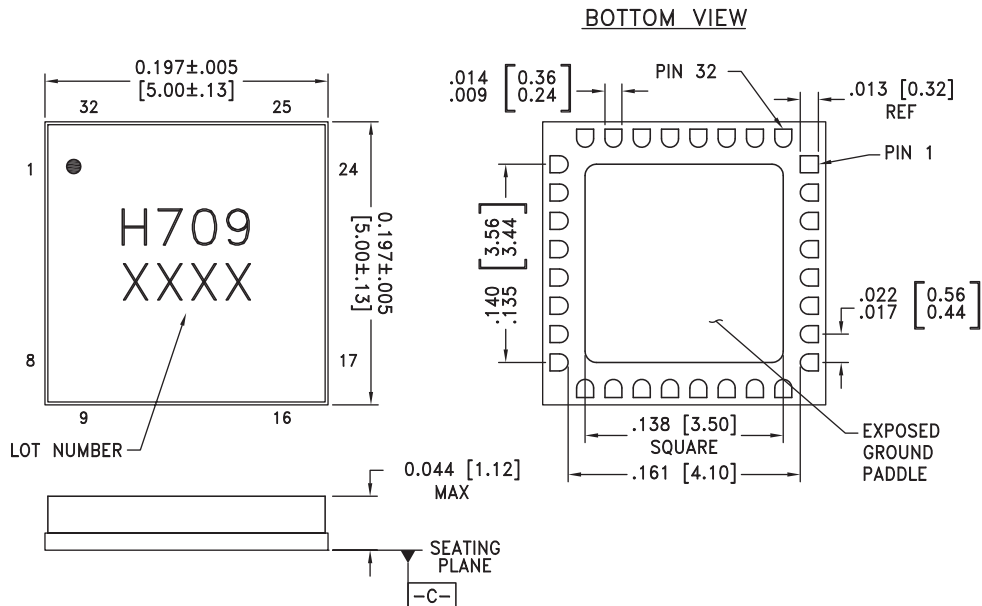

NOTES:

1. PACKAGE BODY MATERIAL: ALUMINA
2. LEAD AND GROUND PADDLE PLATING: 30 - 80 MICROINCHES GOLD OVER 50 MICROINCHES MINIMUM NICKLE
3. DIMENSIONS ARE IN INCHES [MILLIMETERS]
4. LEAD SPACING TOLERANCE IS NON-CUMULATIVE
5. PACKAGE WARP SHALL NOT EXCEED 0.05mm DATUM
6. ALL GROUND LEADS AND GROUND PADDLE MUST BE SOLDERED TO PCB RF GROUND

### Pin Descriptions

Pin Number	Function	Description	Interface Schematic
1 - 6, 8, 12 - 19, 22 - 25, 27, 28	N/C	No Connection required. These pins may be connected to RF/DC ground without affecting performance.	
7	Vdd1	Power supply voltage for LO Amplifier. See application circuit for required external components.	
9, 11, 20, 30, 32	GND	Package bottom must be connected to RF/DC ground.	
10	LOIN	This pin is AC coupled and matched to 50 ohms.	
21	RFOUT	This pin is AC coupled and matched to 50 ohms.	
26	Vdd2	Power supply voltage for RF amplifier. See application circuit for required external components.	
29	IF1	Differential IF input pins. For applications not requiring operation to DC, an off chip DC blocking capacitor should be used. For operation to DC this pin must not source/sink more than 3mA of current or part non-function and possible part failure will result.	
31	IF2		

### Application Circuit

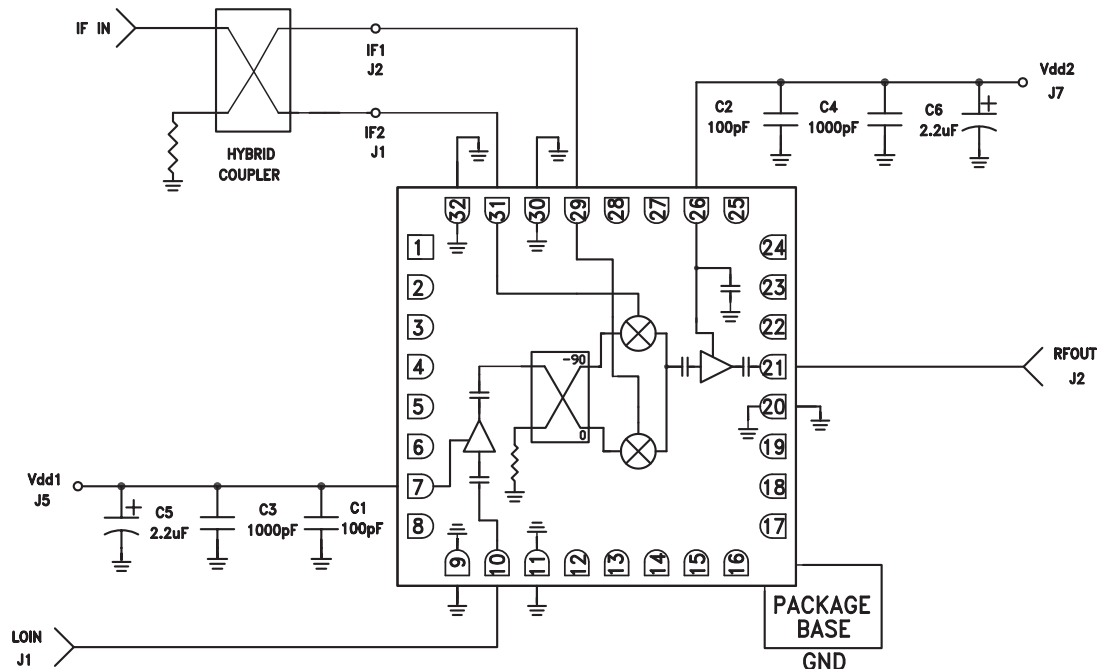

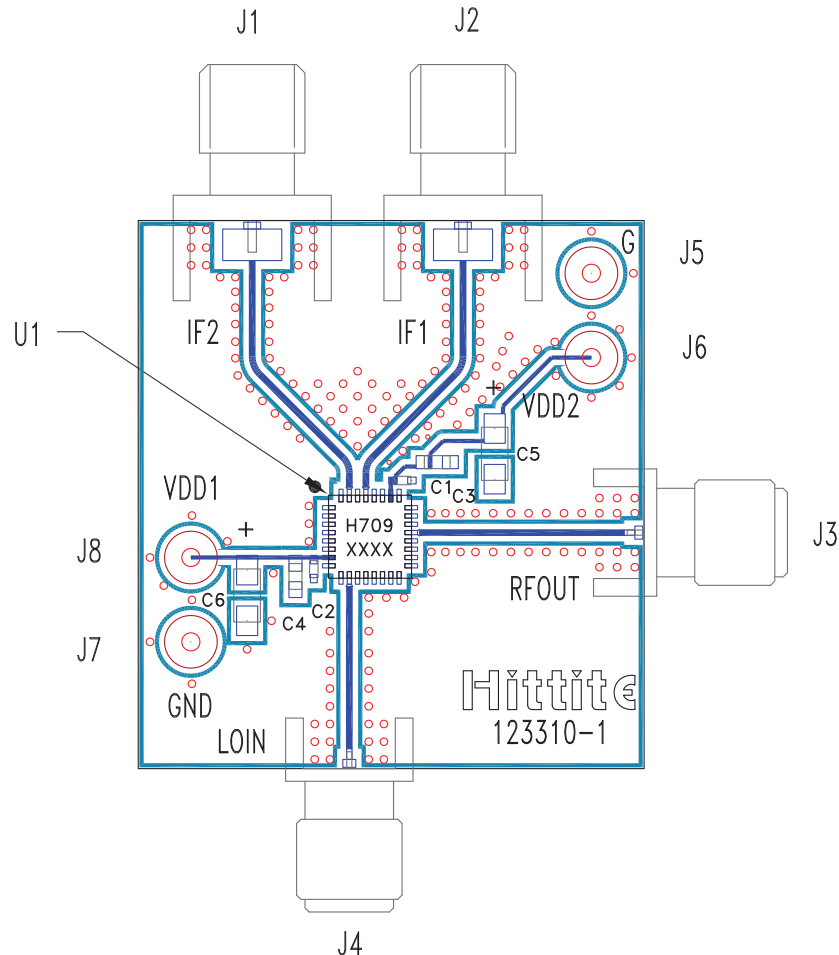
**Evaluation PCB**

**List of Materials for Evaluation PCB 120408 [1]**

Item	Description
J1, J2	PCB Mount SMA Connector
J3, J4	PCB Mount SMA SRI Connector
J5 - J8	DC Pin
C1, C2	100 pF Capacitor, 0402 Pkg.
C3, C4	1000 pF Capacitor, 0603 Pkg.
C5, C6	2.2 $\mu$ F Tantalum Capacitor Case A
U1	HMC709LC5 Upconverter
PCB [2]	123310 Evaluation Board

[1] Reference this number when ordering complete evaluation PCB

[2] Circuit Board Material: Rogers 4350 or Arlon 25 FR, FR4

The circuit board used in the final application should use RF circuit design techniques. Signal lines should have 50 ohm impedance while the package ground leads and exposed paddle should be connected directly to the ground plane similar to that shown. A sufficient number of via holes should be used to connect the top and bottom ground planes. The evaluation circuit board shown is available from Hittite upon request.



Компания «ЭлектроПласт» предлагает заключение долгосрочных отношений при поставках импортных электронных компонентов на взаимовыгодных условиях!

Наши преимущества:

- Оперативные поставки широкого спектра электронных компонентов отечественного и импортного производства напрямую от производителей и с крупнейших мировых складов;
- Поставка более 17-ти миллионов наименований электронных компонентов;
- Поставка сложных, дефицитных, либо снятых с производства позиций;
- Оперативные сроки поставки под заказ (от 5 рабочих дней);
- Экспресс доставка в любую точку России;
- Техническая поддержка проекта, помощь в подборе аналогов, поставка прототипов;
- Система менеджмента качества сертифицирована по Международному стандарту ISO 9001;
- Лицензия ФСБ на осуществление работ с использованием сведений, составляющих государственную тайну;
- Поставка специализированных компонентов (Xilinx, Altera, Analog Devices, Intersil, Interpoint, Microsemi, Aeroflex, Peregrine, Syfer, Eurofarad, Texas Instrument, Miteq, Cobham, E2V, MA-COM, Hittite, Mini-Circuits, General Dynamics и др.);

Помимо этого, одним из направлений компании «ЭлектроПласт» является направление «Источники питания». Мы предлагаем Вам помощь Конструкторского отдела:

- Подбор оптимального решения, техническое обоснование при выборе компонента;
- Подбор аналогов;
- Консультации по применению компонента;
- Поставка образцов и прототипов;
- Техническая поддержка проекта;
- Защита от снятия компонента с производства.



#### Как с нами связаться

**Телефон:** 8 (812) 309 58 32 (многоканальный)

**Факс:** 8 (812) 320-02-42

**Электронная почта:** [org@eplast1.ru](mailto:org@eplast1.ru)

**Адрес:** 198099, г. Санкт-Петербург, ул. Калинина, дом 2, корпус 4, литера А.