Low Power/Fast MODE alternative 200mA LDO REGULATOR

NO.EA-279-160324

OUTLINE

The RP202x Series consist of CMOS-based voltage regulator ICs with high output voltage accuracy, low dropout voltage and low supply current. These ICs perform with the chip enable function and realize a standby mode with ultra low supply current. To prevent the destruction by over current, the current limit circuit is included. The RP202 Series have 3-mode. One is standby mode with CE pin. The other two are the fast response mode (Fast Mode) and the low power mode, and switch over automatically according to the load current of the LDO. Supply current of IC itself at light load is automatically reduced. The output voltage is maintained between Fast Mode and ECO Mode.

The RP202x consists of a voltage reference unit, an error amplifier, a resistor net for voltage setting, and a current limit circuit.

Since the packages for these ICs are SOT-23-5, SC-88A, and DFN(PLP)1010-4, high density mounting of the ICs on boards is possible.

FEATURES

- Input Voltage Range 1.4V to 5.25V
- Output Voltage Range 0.8V to 4.0V (0.1V steps)
(For other voltages, please refer to MARK INFORMATIONS.)
- Supply Current ($I_{OUT}=0mA$) Typ. 2.5 μA
- Supply Current ($I_{OUT}=10mA$) Typ. 50 μA
- Supply Current (Standby Mode) Typ. 0.1 μA
- Dropout Voltage Typ. 0.20V ($I_{OUT}=200mA$, $V_{OUT}=2.8V$)
- Ripple Rejection..... Typ. 70dB ($f=1kHz$, $V_{OUT}=2.8V$, $I_{OUT}=30mA$)
- Line Regulation..... Typ. 0.02%/V ($I_{OUT}=10mA$)
- Packages DFN(PLP)1010-4, SC-88A, SOT-23-5
- Built-in Foldback Protection Circuit..... Typ. 60mA (Current at short mode)
- Built-in Constant Slope Circuit (Soft-start Function)
- Ceramic capacitors are recommended to be used with this IC0.47 μF or more

APPLICATIONS

- Power source for portable communication equipment.
- Power source for electrical appliances such as cameras, VCRs and camcorders.
- Power source for battery-powered equipment.

BLOCK DIAGRAMS

RP202xxxxB

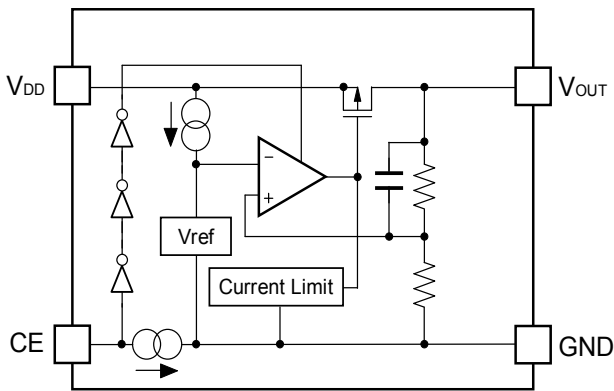

RP202xxxxD

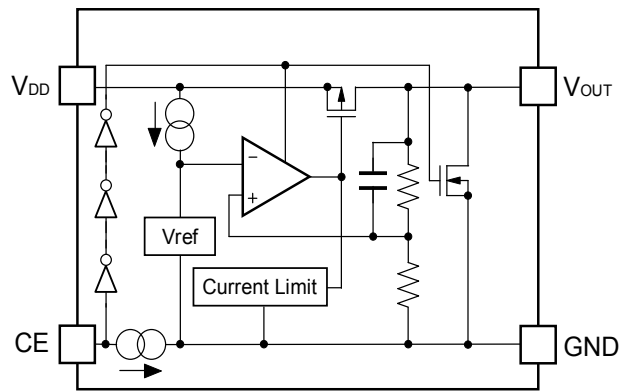

SELECTION GUIDE

The output voltage, auto discharge function, and package, for the ICs can be selected at the user's request.

Product Name	Package	Quantity per Reel	Pb Free	Halogen Free
RP202Kxx1*-TR	DFN(PLP)1010-4	10,000pcs	Yes	Yes
RP202Qxx2*-TR-FE	SC-88A	3,000pcs	Yes	Yes
RP202Nxx1*-TR-FE	SOT-23-5	3,000pcs	Yes	Yes

xx: The output voltage can be designated in the range from 0.8V(08) to 4.0V(40) in 0.1V steps.

* : The auto discharge function at off state are options as follows.
 (B) without auto discharge function at off state
 (D) with auto discharge function at off state

Auto-discharge function quickly lowers the output voltage to 0V, when the chip enable signal is switched from the active mode to the standby mode, by releasing the electrical charge accumulated in the external capacitor.

PIN CONFIGURATIONS

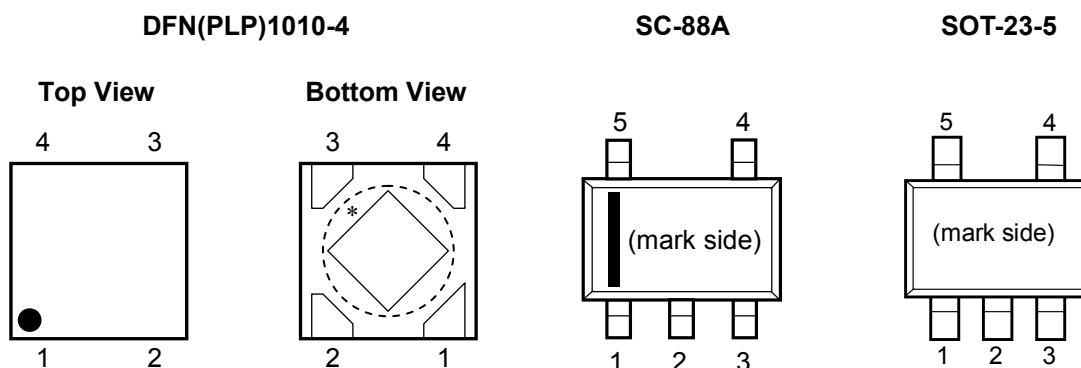

PIN DESCRIPTIONS

DFN(PLP)1010-4

Pin No	Symbol	Pin Description
1	V_{OUT}	Output Pin
2	GND	Ground Pin
3	CE	Chip Enable Pin ("H" Active)
4	V_{DD}	Input Pin

* Tab is GND level. (They are connected to the reverse side of this IC.) The tab is better to be connected to the GND, but leaving it open is also acceptable.

SC-88A

Pin No	Symbol	Pin Description
1	CE	Chip Enable Pin ("H" Active)
2	NC	No Connection
3	GND	Ground Pin
4	V_{OUT}	Output Pin
5	V_{DD}	Input Pin

SOT-23-5

Pin No	Symbol	Pin Description
1	V_{DD}	Input Pin
2	GND	Ground Pin
3	CE	Chip Enable Pin ("H" Active)
4	NC	No Connection
5	V_{OUT}	Output Pin

ABSOLUTE MAXIMUM RATINGS

Symbol	Item	Rating	Unit
V_{IN}	Input Voltage	6.0	V
V_{CE}	Input Voltage (CE Pin)	-0.3 to 6.0	V
V_{OUT}	Output Voltage	-0.3 to $V_{IN} + 0.3$	V
I_{OUT}	Output Current	220	mA
P_D	Power Dissipation (DFN(PLP)1010-4) (Standard Test Land Pattern) *	400	mW
	Power Dissipation (SC-88A) (Standard Test Land Pattern) *	380	
	Power Dissipation (SOT-23-5) (Standard Test Land Pattern) *	420	
T_a	Operating Temperature Range	-40 to 85	°C
T_{stg}	Storage Temperature Range	-55 to 125	°C

*) For Power Dissipation, please refer to PACKAGE INFORMATION.

ABSOLUTE MAXIMUM RATINGS

Electronic and mechanical stress momentarily exceeded absolute maximum ratings may cause the permanent damages and may degrade the life time and safety for both device and system using the device in the field. The functional operation at or over these absolute maximum ratings is not assured.

RECOMMENDED OPERATING CONDITIONS (ELECTRICAL CHARACTERISTICS)

All of electronic equipment should be designed that the mounted semiconductor devices operate within the recommended operating conditions. The semiconductor devices cannot operate normally over the recommended operating conditions, even if when they are used over such conditions by momentary electronic noise or surge. And the semiconductor devices may receive serious damage when they continue to operate over the recommended operating conditions.

ELECTRICAL CHARACTERISTICS

V_{IN} =Set $V_{OUT}+1V$, $I_{OUT}=1mA$, $C_{IN}=C_{OUT}=0.47\mu F$, unless otherwise noted.

The specification in is checked and guaranteed by design engineering at $-40^{\circ}C \leq T_a \leq 85^{\circ}C$. (Ta=25°C)

Symbol	Item	Conditions	Min.	Typ.	Max.	Unit	
V_{OUT}	Output Voltage	$I_{OUT}=5mA$ (Fast Mode) $T_a=25^{\circ}C$	$V_{OUT} > 2.0V$	$\times 0.99$		$\times 1.01$	V
			$V_{OUT} \leq 2.0V$	-20mV		20mV	
		$I_{OUT}=5mA$ (Fast Mode) $-40^{\circ}C \leq T_a \leq 85^{\circ}C$	$V_{OUT} > 2.0V$	×0.965		×1.025	
			$V_{OUT} \leq 2.0V$	-70mV		50mV	
I_{OUT}	Output Current		200			mA	
$\frac{\Delta V_{OUT}}{\Delta I_{OUT}}$	Load Regulation	$1mA \leq I_{OUT} \leq 10mA$	$V_{OUT} > 2.0V$	-1.0		1.0	%
			$V_{OUT} \leq 2.0V$	-20		20	mV
		$10mA \leq I_{OUT} \leq 200mA$		-20	10	30	mV
V_{DIF}	Dropout Voltage	Refer to the "Dropout Voltage"					
I_{SS1}	Supply Current ($I_{OUT}=0mA$)*1	$I_{OUT}=0mA$		2.5	5.0	μA	
I_{SS2}	Supply Current ($I_{OUT}=10mA$)	$I_{OUT}=10mA$		50		μA	
Istandby	Standby Current	$V_{CE}=GND$		0.1	1.0	μA	
I_{OUTH}	Fast Mode switch-over current	I_{OUT} = Light load to Heavy load			8.0	mA	
I_{OUTL}	Low Power Mode switch-over current	I_{OUT} = Heavy load to Light load	1.0	2.0		mA	
$\frac{\Delta V_{OUT}}{\Delta V_{IN}}$	Line Regulation	$V_{OUT}+0.5V \leq V_{IN} \leq 5V$ $1.4V \leq V_{IN}$	$I_{OUT}=1mA$ (Low Power Mode)			±0.50	%V
			$I_{OUT}=10mA$ (Fast Mode)		± 0.02	±0.10	
RR	Ripple Rejection	$f=1kHz$ Ripple 0.2Vp-p $V_{IN}=V_{OUT}+1.0V$, $I_{OUT}=30mA$	$V_{OUT} \leq 1.8V$		75		dB
			$1.8 < V_{OUT} \leq 2.8V$		70		
			$2.8 < V_{OUT} \leq 3.3V$		65		
			$3.3 < V_{OUT}$		60		
V_{IN}	Input Voltage		1.4		5.25	V	
$\frac{\Delta V_{OUT}}{\Delta T_a}$	Output Voltage Temperature Coefficient	$-40^{\circ}C \leq T_a \leq 85^{\circ}C$		± 100		ppm/ $^{\circ}C$	
I_{SC}	Short Current Limit	$V_{OUT}=0V$		60		mA	
I_{CEPD}	CE Pull-down Constant Current			0.3	0.6	μA	
V_{CEH}	CE Input Voltage "H"		1.0			V	
V_{CEL}	CE Input Voltage "L"				0.4	V	
R_{LOW}	Low Output Nch Tr. ON Resistance (of D version)	$V_{IN} = 4.0V$ $V_{CE} = 0V$		60		Ω	

All of units are tested and specified under load conditions such that $T_j \approx T_a = 25^{\circ}C$ except for Ripple Rejection, Output Voltage Temperature Coefficient.

*1) The value of supply current is excluding the Pull-down constant current of CE Pin.

RP202

NO.EA-279-160324

Dropout Voltage

Ta=25°C

Output Voltage V _{OUT} (V)	Dropout Voltage V _{DIF} (V)		
	Condition	Typ.	Max.
0.8 ≤ V _{OUT} < 0.9	I _{OUT} =200mA	0.60	0.79
0.9 ≤ V _{OUT} < 1.0		0.55	0.73
1.0 ≤ V _{OUT} < 1.1		0.50	0.64
1.1 ≤ V _{OUT} < 1.2		0.45	0.61
1.2 ≤ V _{OUT} < 1.3		0.40	0.56
1.3 ≤ V _{OUT} < 1.4		0.37	0.53
1.4 ≤ V _{OUT} < 1.5		0.34	0.48
1.5 ≤ V _{OUT} < 1.8		0.31	0.43
1.8 ≤ V _{OUT} < 2.1		0.27	0.39
2.1 ≤ V _{OUT} < 2.5		0.245	0.36
2.5 ≤ V _{OUT} < 2.8		0.215	0.31
2.8 ≤ V _{OUT} < 3.0		0.20	0.29
3.0 ≤ V _{OUT} < 3.3		0.19	0.28
3.3 ≤ V _{OUT} < 3.6		0.18	0.27
3.6 ≤ V _{OUT}		0.175	0.27

TYPICAL APPLICATION

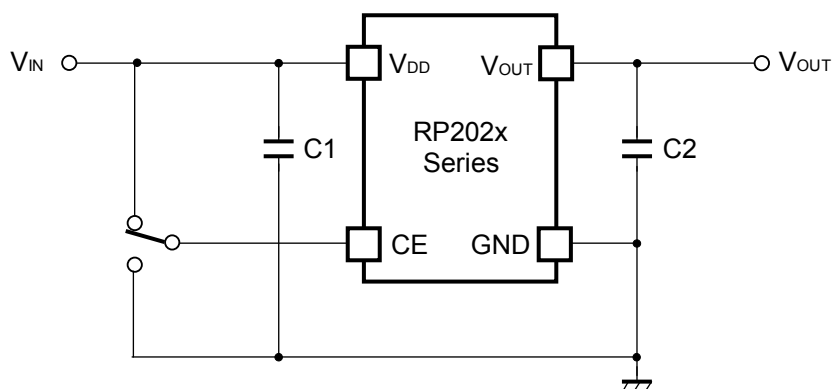

(External Components)

C1, C2 : Ceramic Capacitor 0.47 μ F MURATA: GRM155B31A474KE14

TECHNICAL NOTES

When using these ICs, consider the following points:

Phase Compensation

In these ICs, phase compensation is made for securing stable operation even if the load current is varied. For this purpose, use a capacitor C2 with 0.47 μ F or more and good ESR (Equivalent Series Resistance).

(Note: If additional ceramic capacitors are connected with parallel to the output pin with an output capacitor for phase compensation, the operation might be unstable. Because of this, test these ICs with as same external components as ones to be used on the PCB.)

PCB Layout

The impedances of V_{DD} line and GND line has to be low as possible. The high impedances may result in the unstable operation or a noise pickup. The output capacitor with 0.47 μ F or more should be placed between V_{DD} and GND. The line from V_{DD} to the output capacitor, and the line from the output capacitor to GND must be wired as short as possible.

The output capacitor is placed between V_{OUT} and GND as phase compensation. The line from V_{OUT} to the output capacitor, and the line from the capacitor to GND must be wired as short as possible. Please refer to the "Basic Test Circuit" below.

TEST CIRCUITS

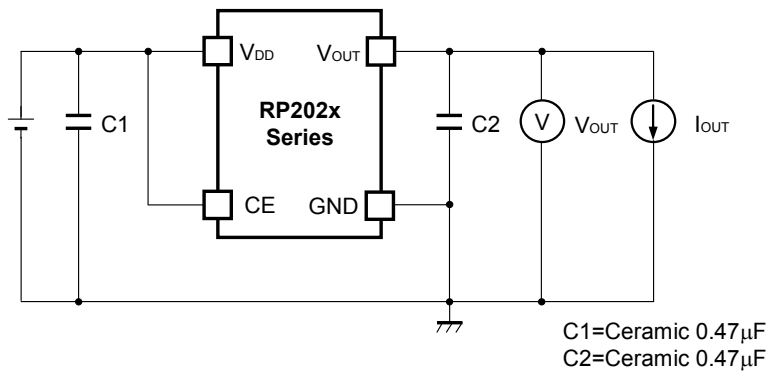

Basic Test Circuit

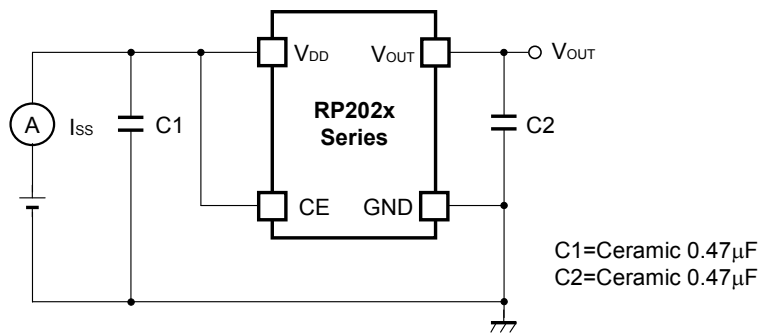

Test Circuit for Supply Current

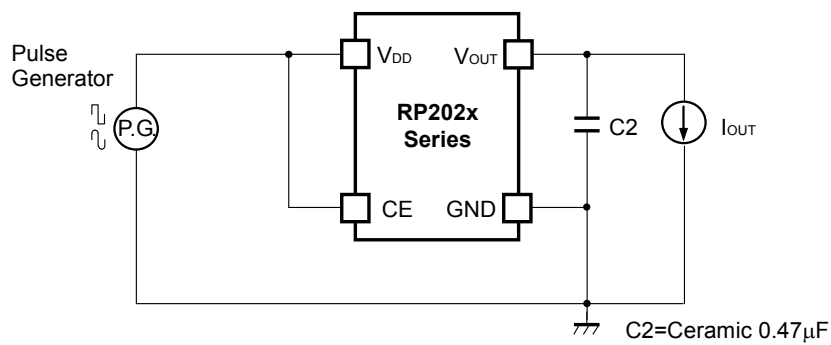

Test Circuit for Ripple Rejection

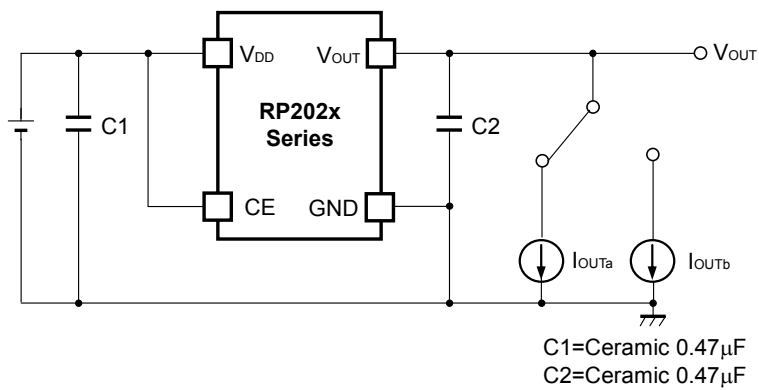

Test Circuit for Load Transient Response

TYPICAL CHARACTERISTICS

1) Output Voltage vs. Output Current (C1=0.47μF, C2=0.47μF, Ta=25°C)

RP202x08xx

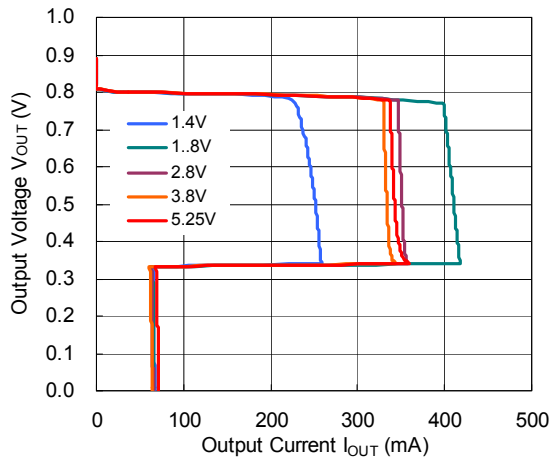

RP202x18xx

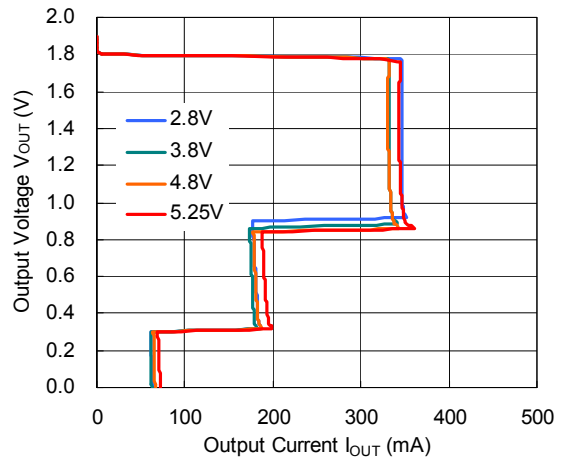

RP202x28xx

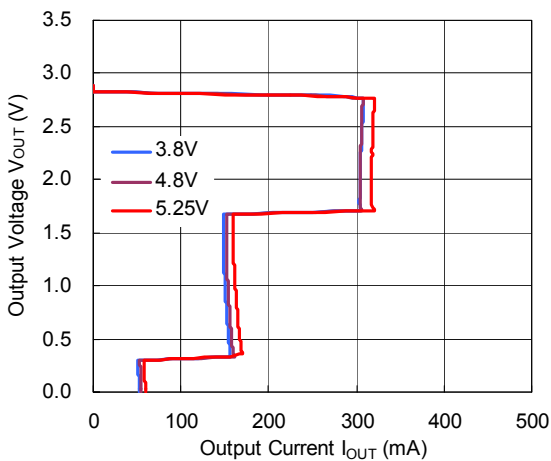

RP202x40xx

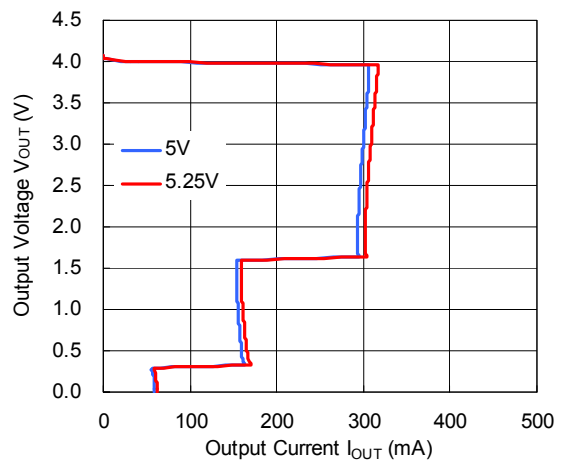

2) Output Voltage vs. Input Voltage (C1=0.47μF, C2=0.47μF, Ta=25°C)

RP202x08xx

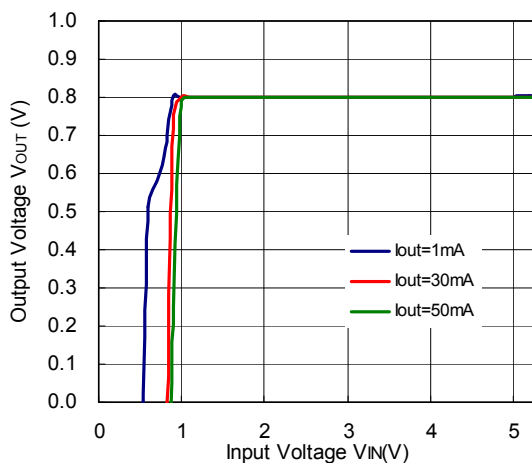

RP202x18xx

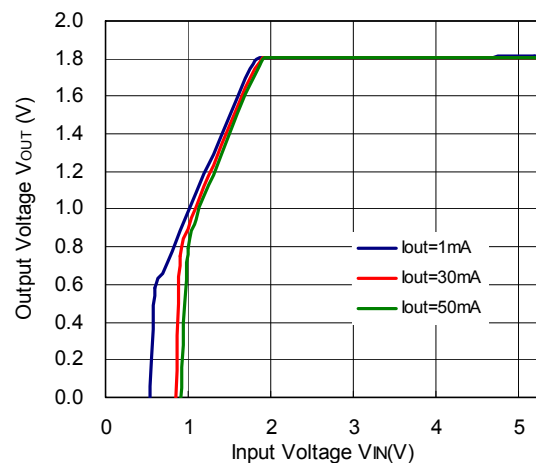

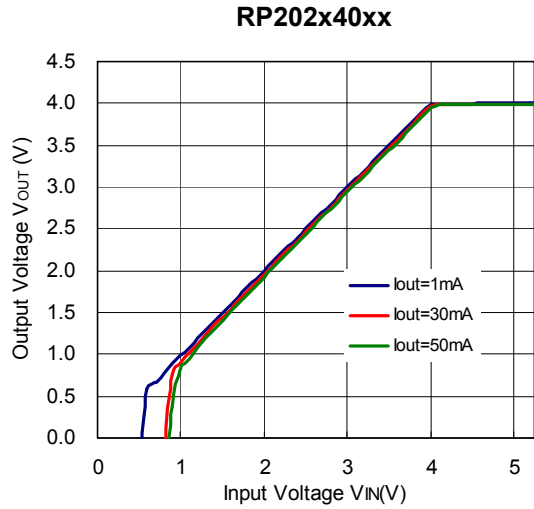
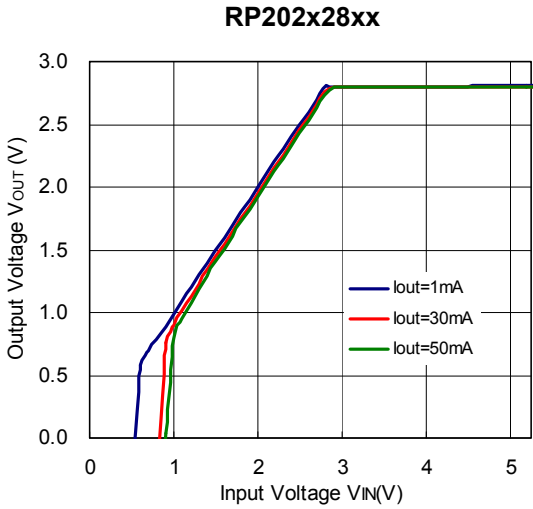

3) Supply Current vs. Input Voltage ($C1=0.47\mu F$, $C2=0.47\mu F$, $T_a=25^\circ C$)

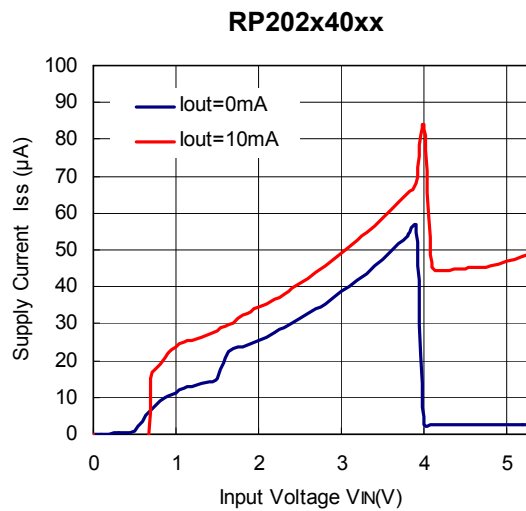
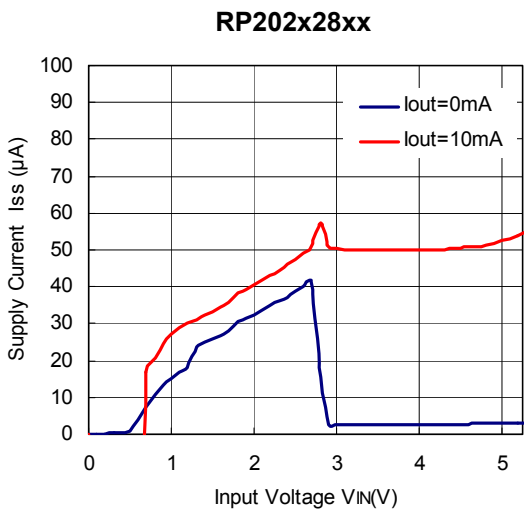
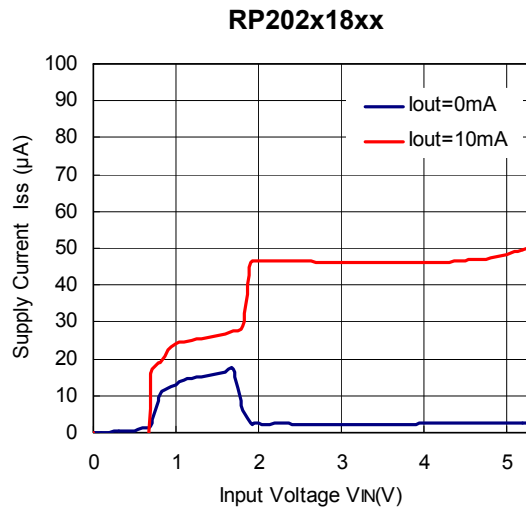
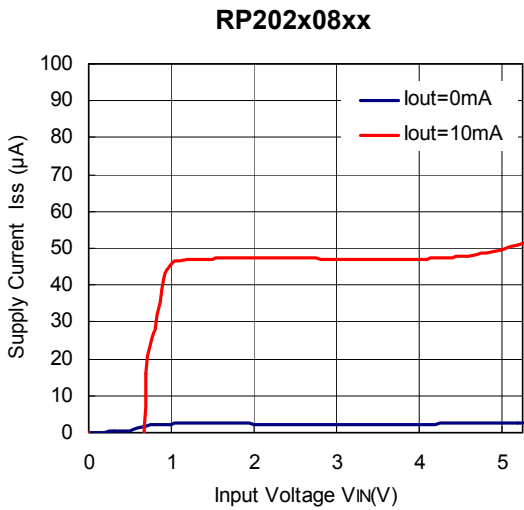

4) Supply Current vs. Output Current (C1=0.47μF, C2=0.47μF, Ta=25°C)

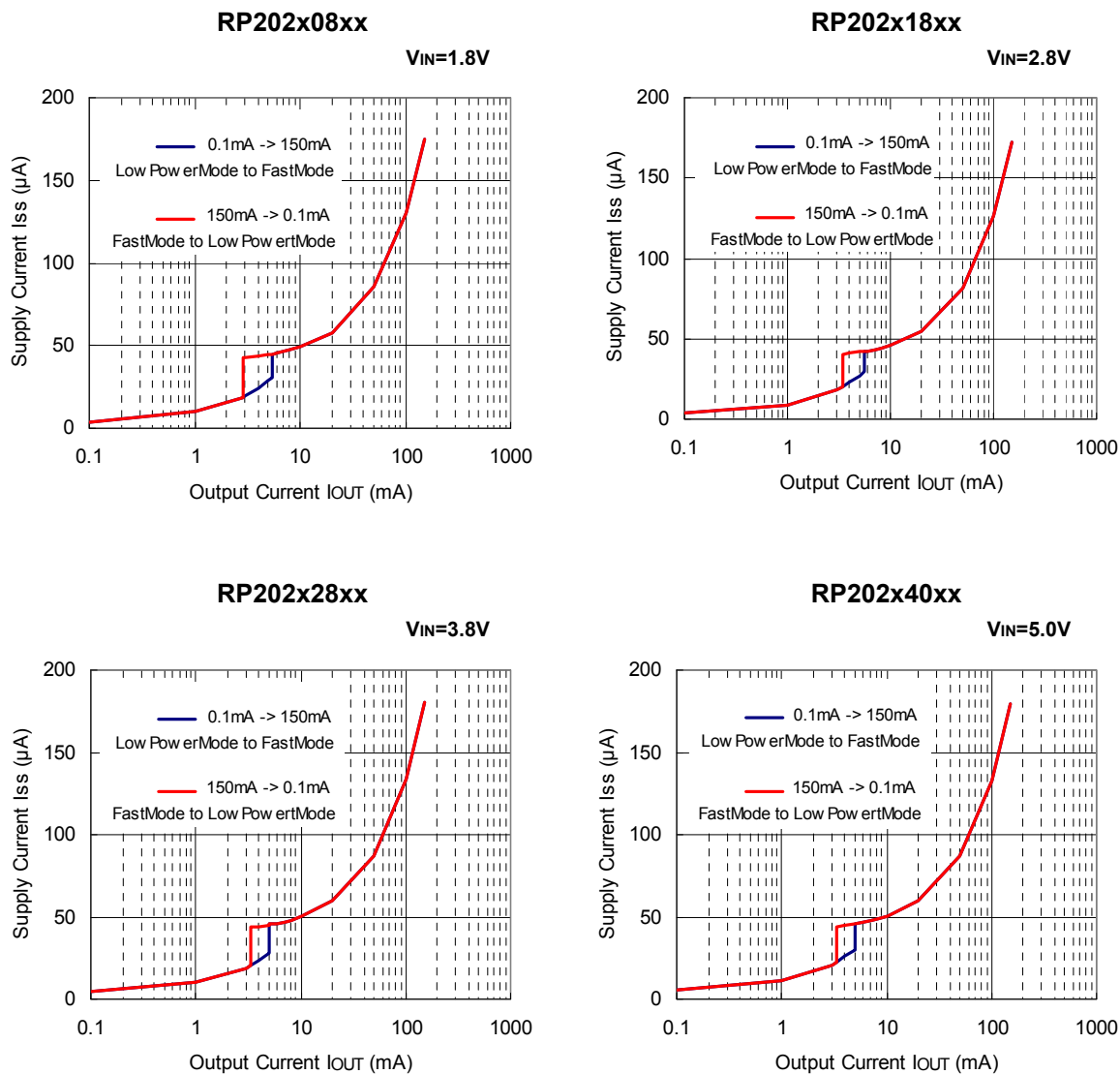

5) Output Voltage vs. Temperature (C1=0.47μF, C2=0.47μF, I_{OUT}=1mA)

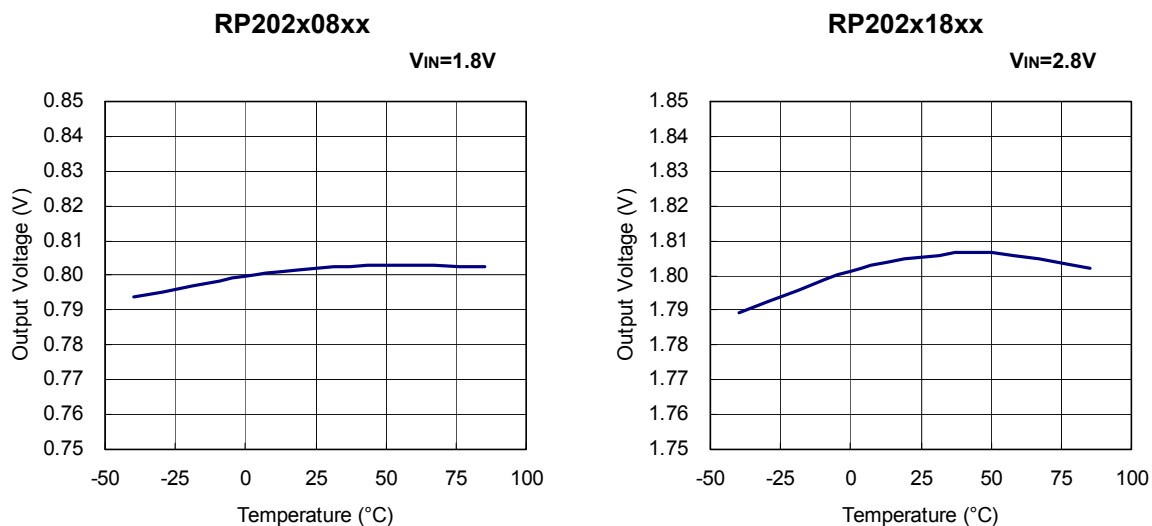

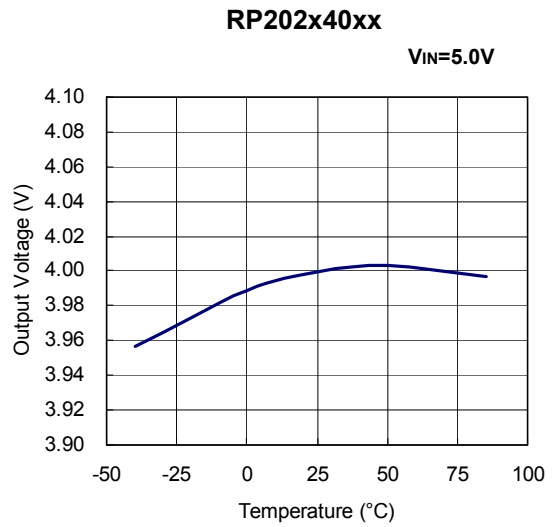
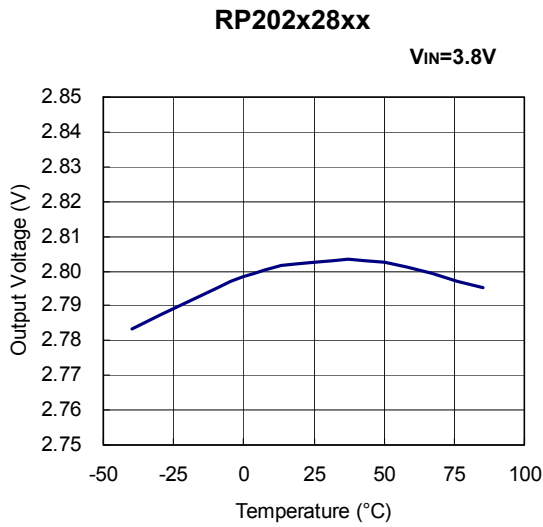

6) Supply Current vs. Temperature ($C1=0.47\mu F$, $C2=0.47\mu F$)

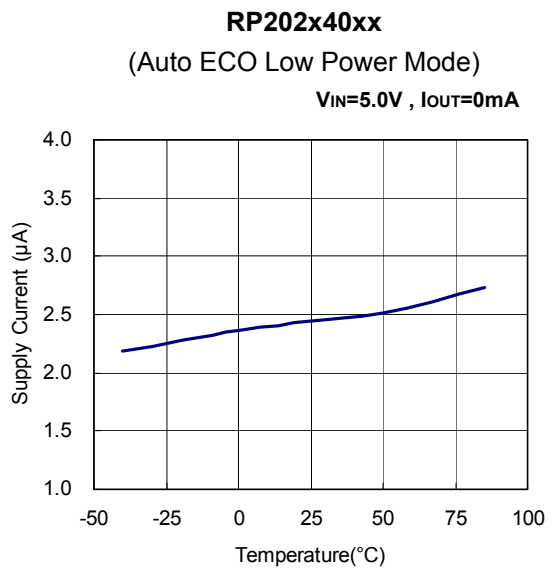
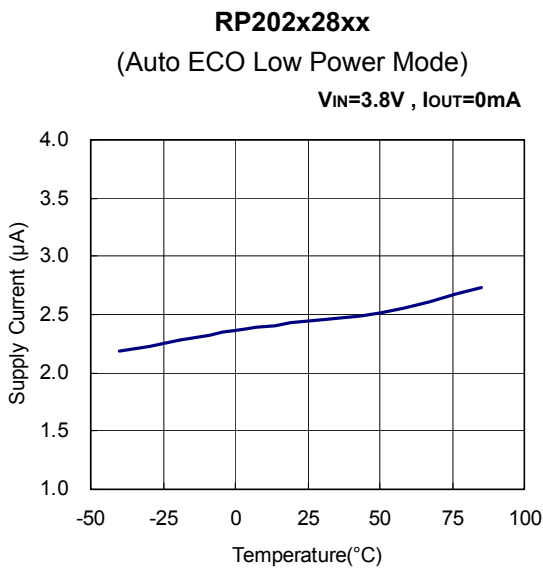
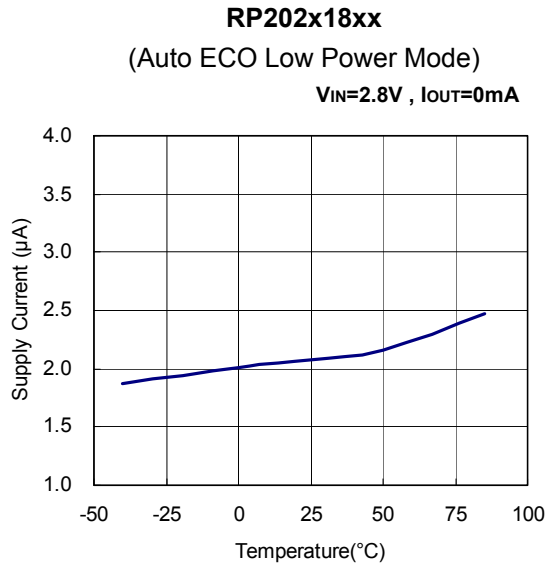
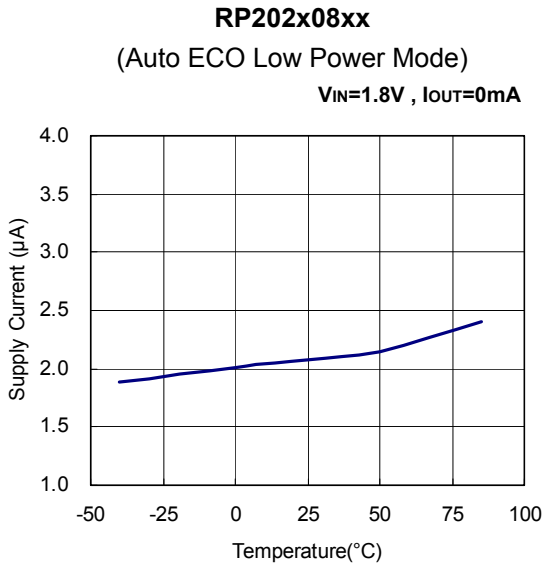

RP202x08xx
(Auto ECO FAST Mode)
 $V_{IN}=1.8V$, $I_{OUT}=10mA$

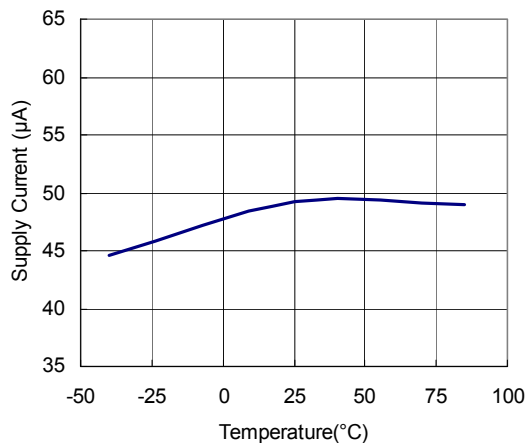

RP202x18xx
(Auto ECO FAST Mode)
 $V_{IN}=2.8V$, $I_{OUT}=10mA$

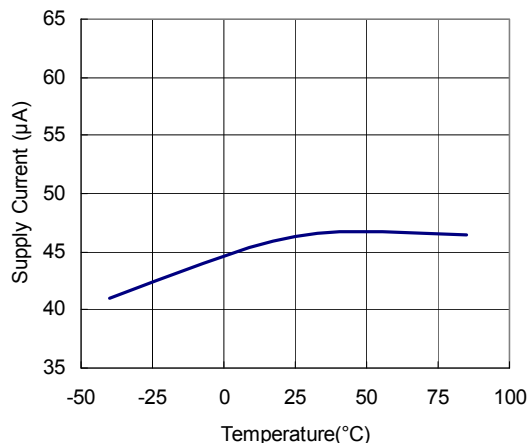

RP202x28xx
(Auto ECO FAST Mode)
 $V_{IN}=3.8V$, $I_{OUT}=10mA$

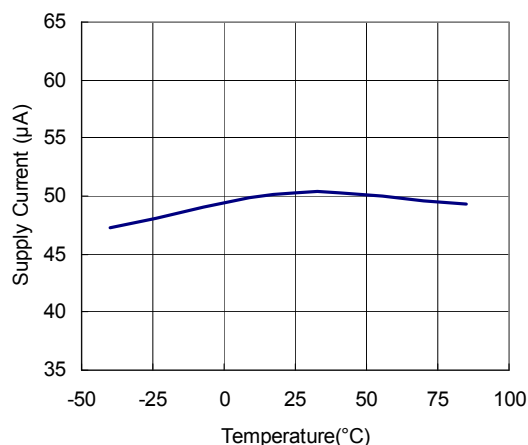

RP202x40xx
(Auto ECO FAST Mode)
 $V_{IN}=5.0V$, $I_{OUT}=10mA$

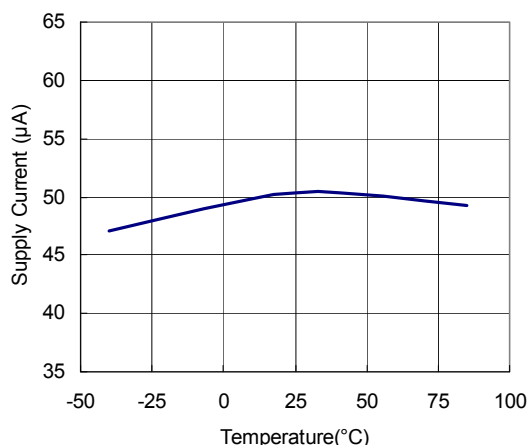

7) Dropout Voltage vs. Output Current ($C1=0.47\mu F$, $C2=0.47\mu F$)

RP202x08xx

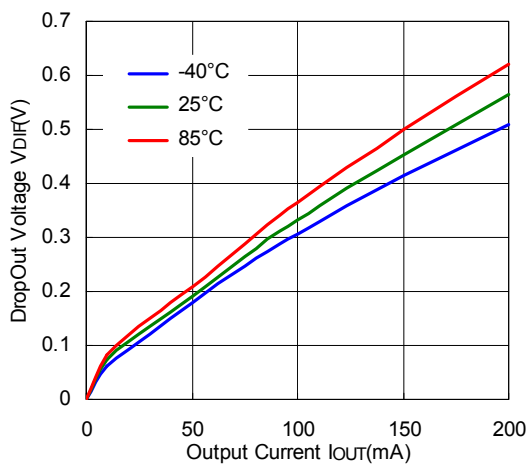

RP202x10xx

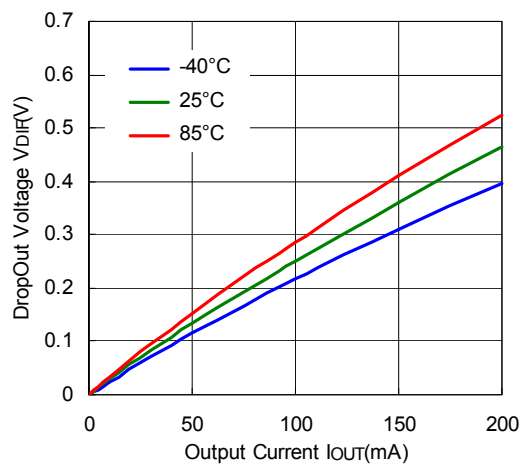

RP202x12xx

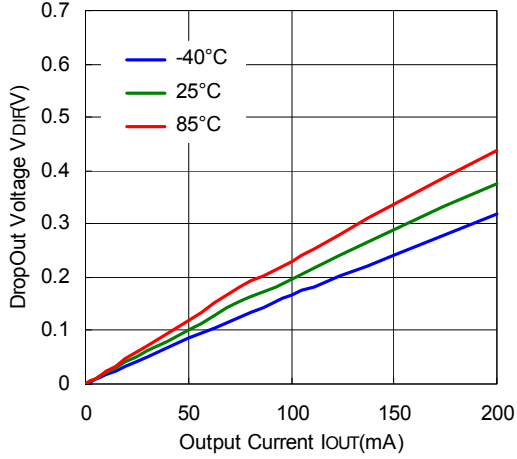

RP202x15xx

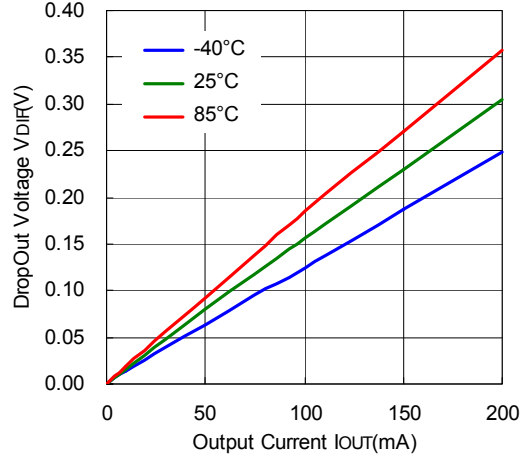

RP202x18xx

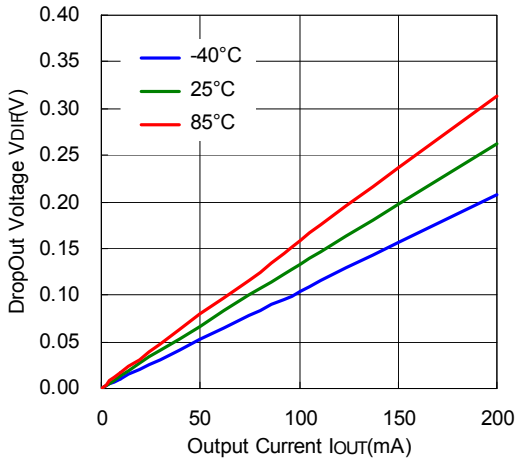

RP202x21xx

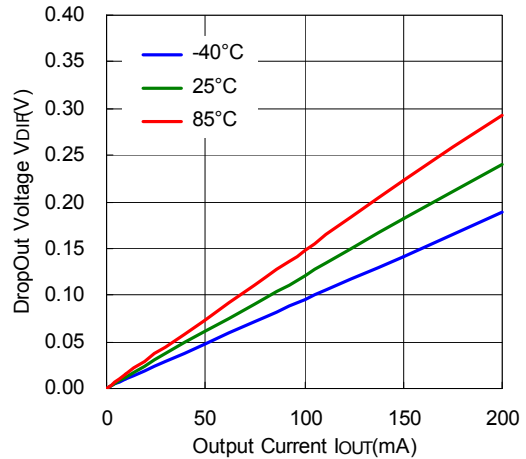

RP202x28xx

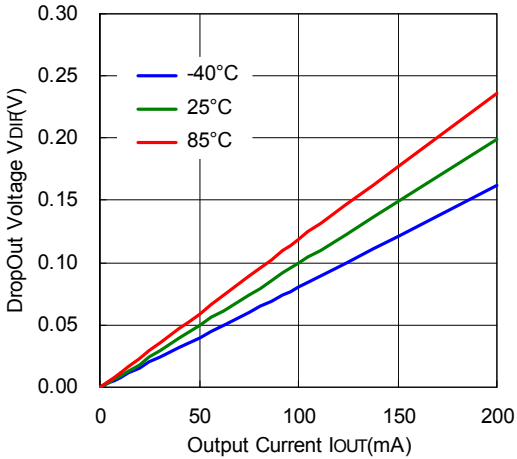

RP202x33xx

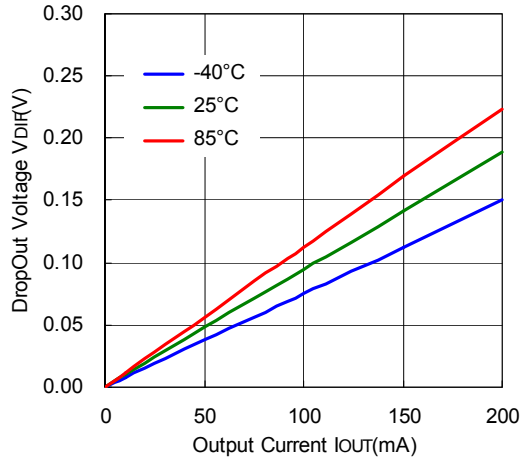

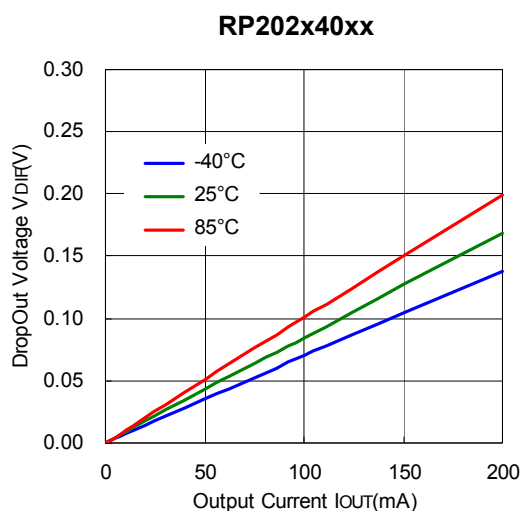

8) Dropout Voltage vs Set Output Voltage

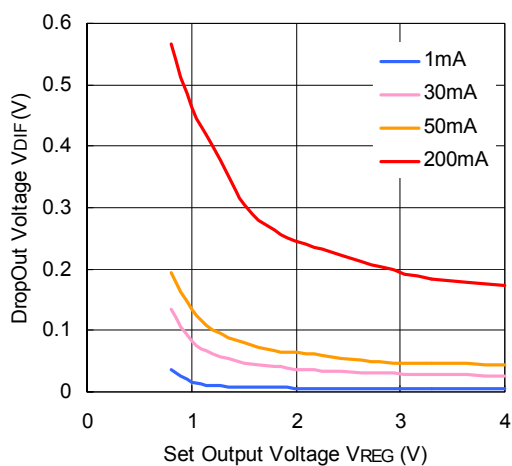

9) Maximum Output Current vs. Set Output Voltage ($C1=0.47\mu F$, $C2=0.47\mu F$, $V_{IN}=1.4V$)

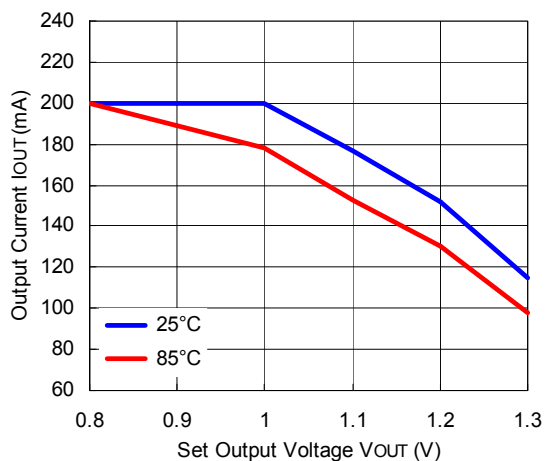

RP202

NO.EA-279-160324

10) Ripple Rejection vs. Input Bias Voltage (C1=none, C2=0.47μF, Ripple=0.2Vp-p, Ta=25°C)

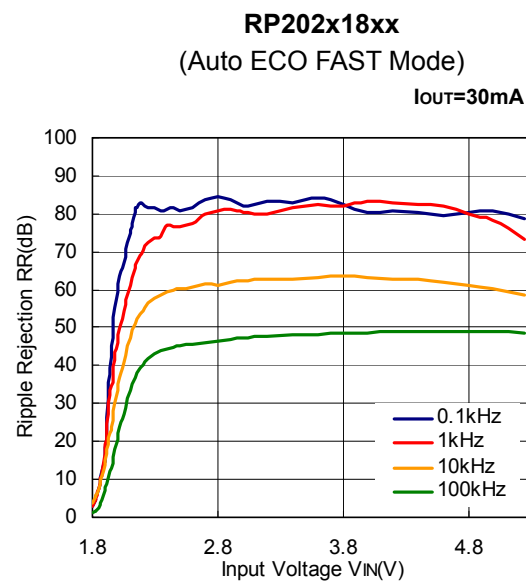
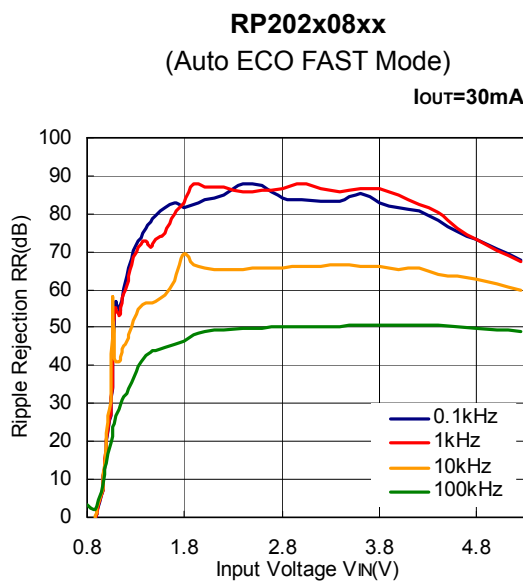
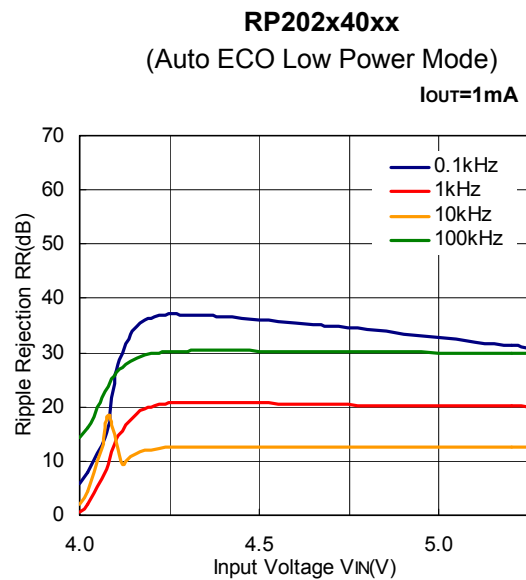
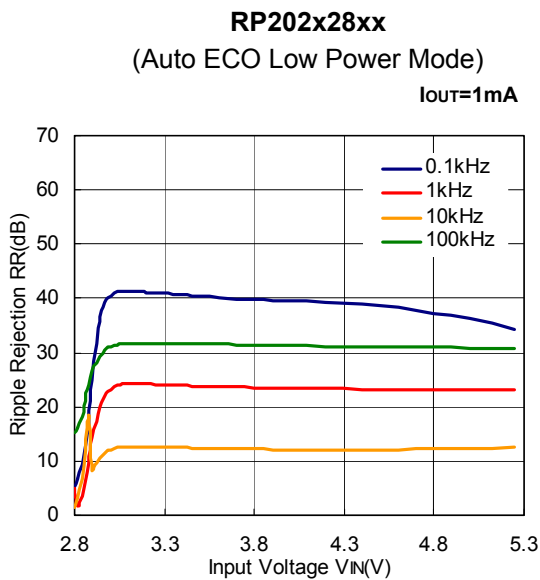
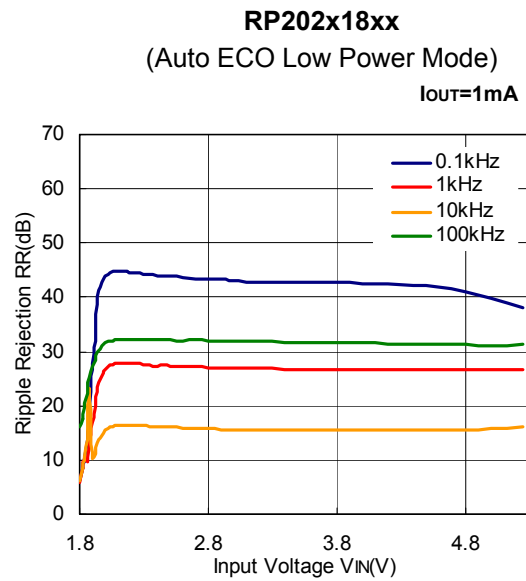
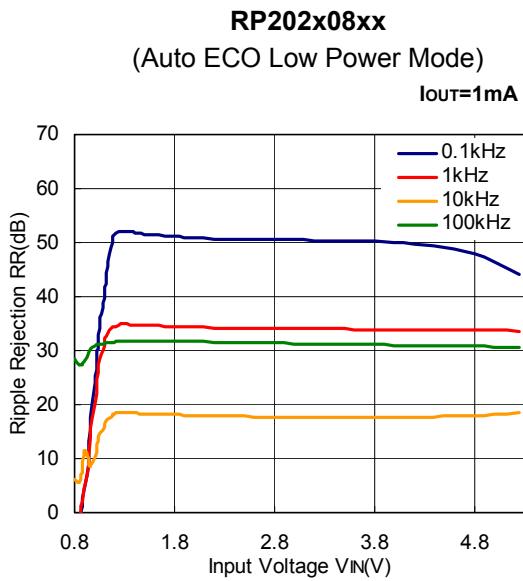

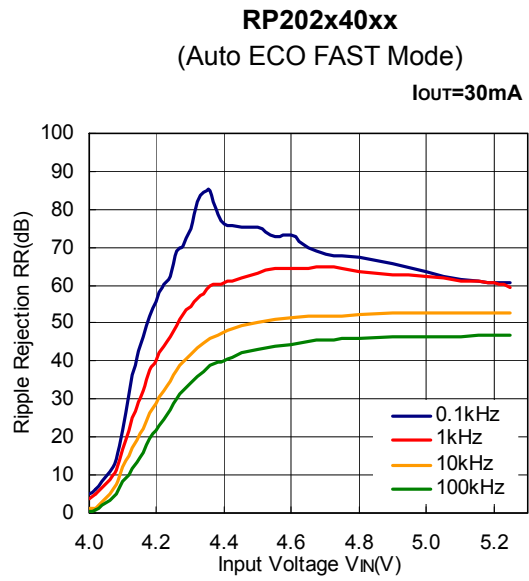
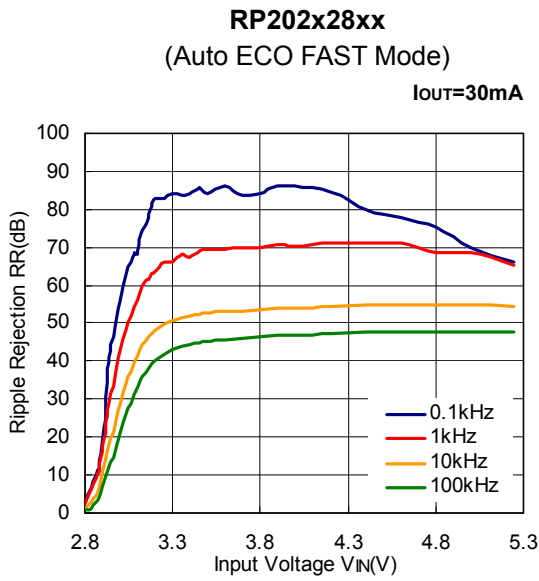

11) Ripple Rejection vs. Frequency ($C_1=none$, $C_2=0.47\mu F$, Ripple=0.2Vp-p, $T_a=25^\circ C$)

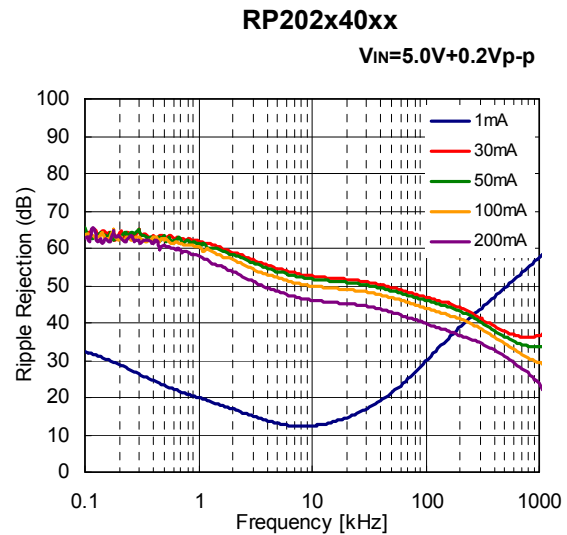
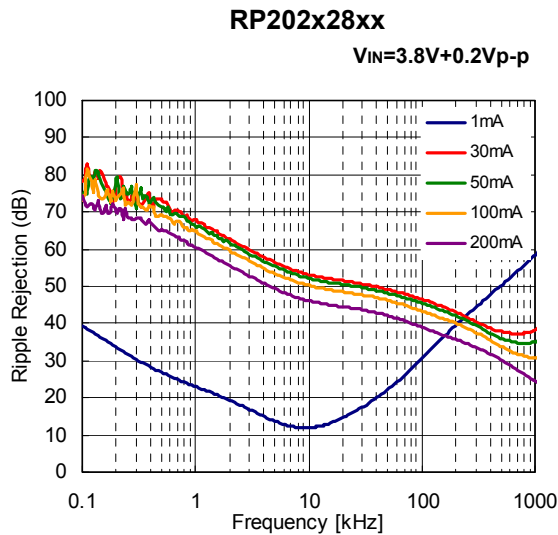
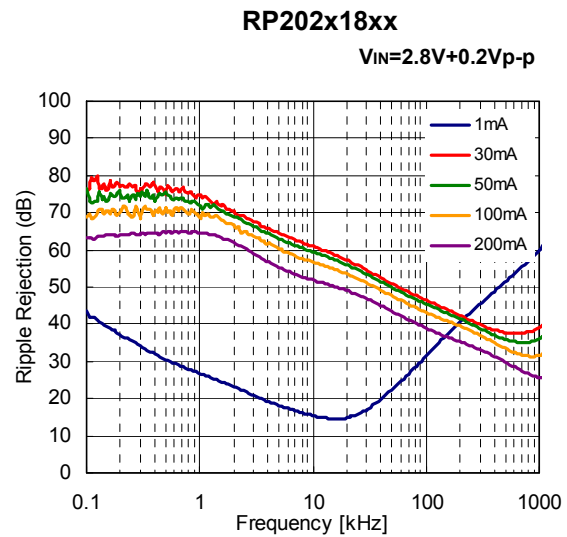
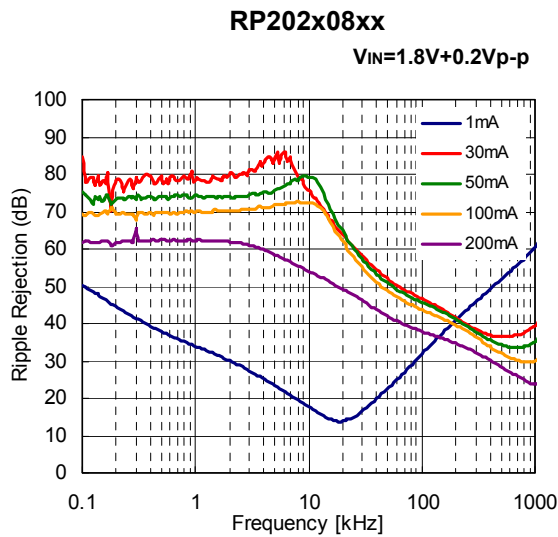

12) Input Transient Response (C1=none, C2=0.47μF, tr=tf=5μs, Ta=25°C)

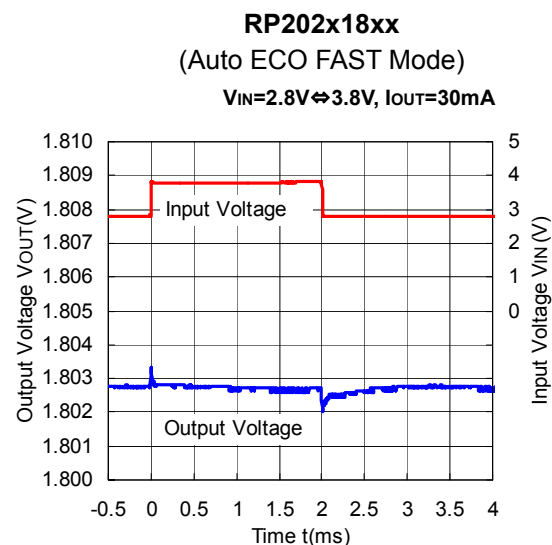
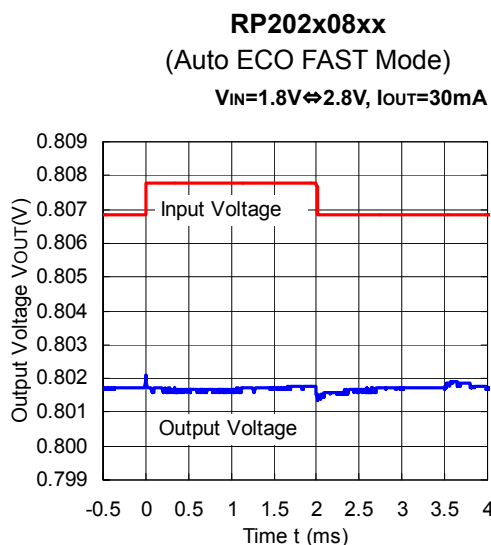
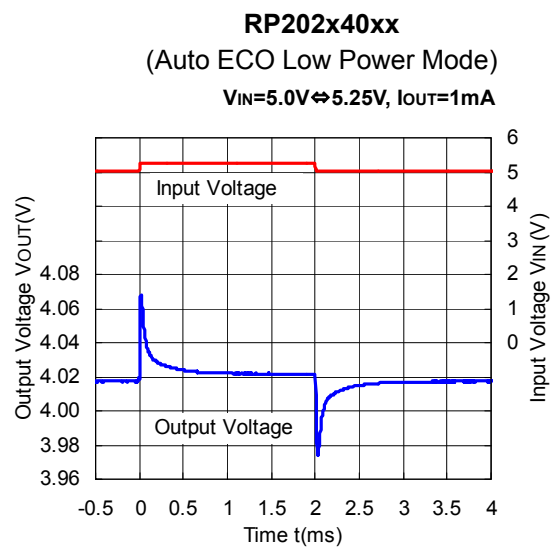
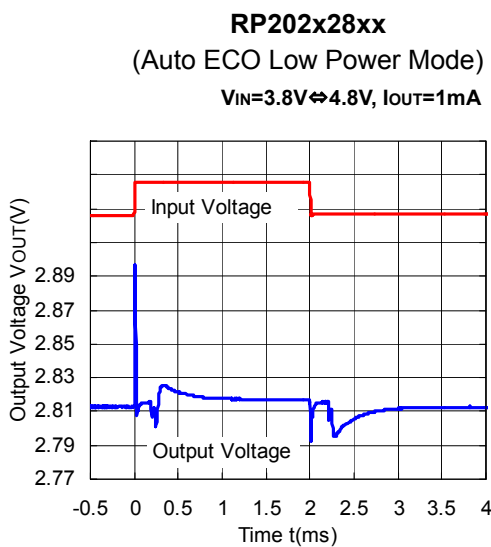
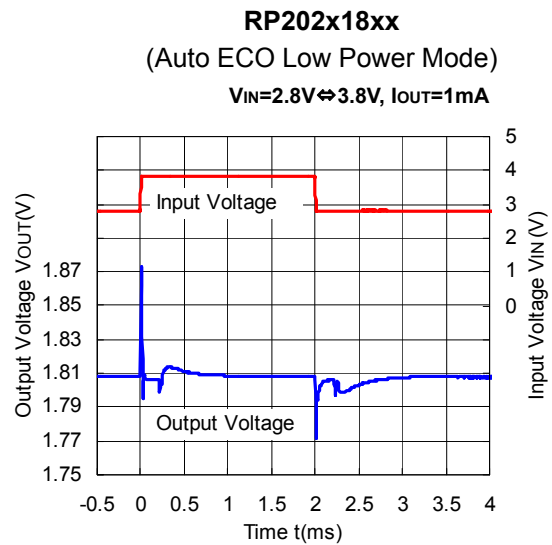
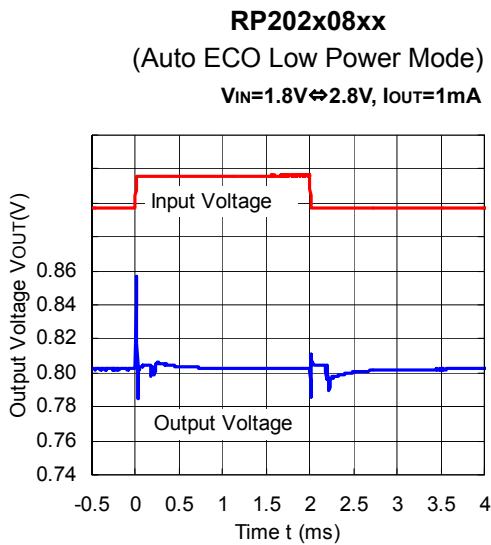

RP202x28xx
(Auto ECO FAST Mode)

V_{IN}=3.8V↔4.8V, I_{OUT}=30mA

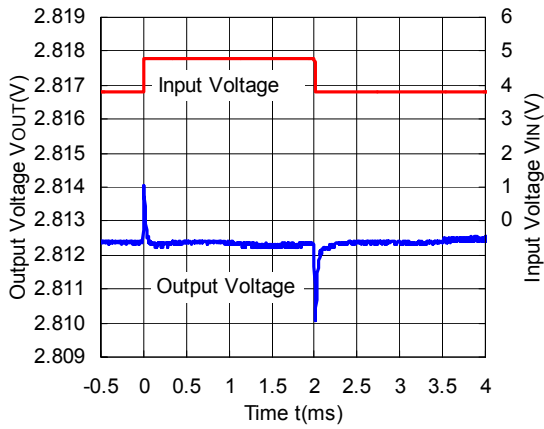

RP202x40xx
(Auto ECO FAST Mode)

V_{IN}=5.0V↔5.25V, I_{OUT}=30mA

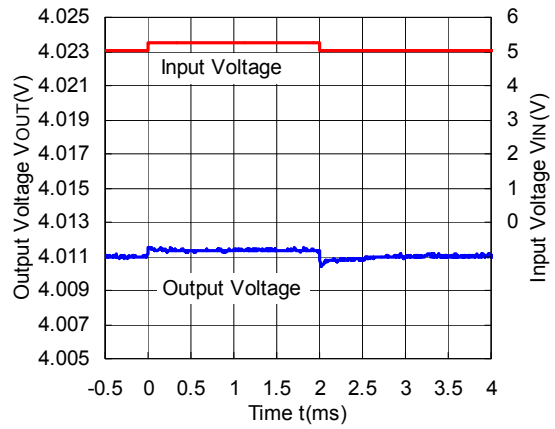

13) Load Transient Response (C1=0.47μF, C2=0.47μF, tr=tf=0.5μs, Ta=25°C)

RP202x08xx

(Auto ECO Low Power Mode↔FAST Mode)

V_{IN}=1.8V

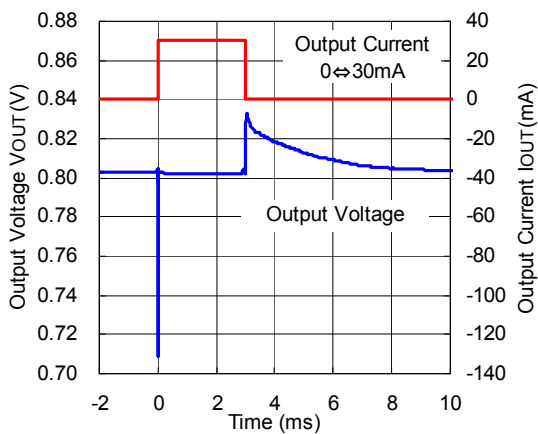

RP202x18xx

(Auto ECO Low Power Mode↔FAST Mode)

V_{IN}=2.8V

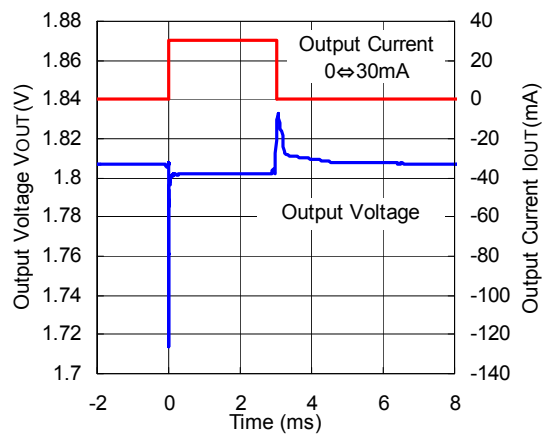

RP202x28xx

(Auto ECO Low Power Mode↔FAST Mode)

V_{IN}=3.8V

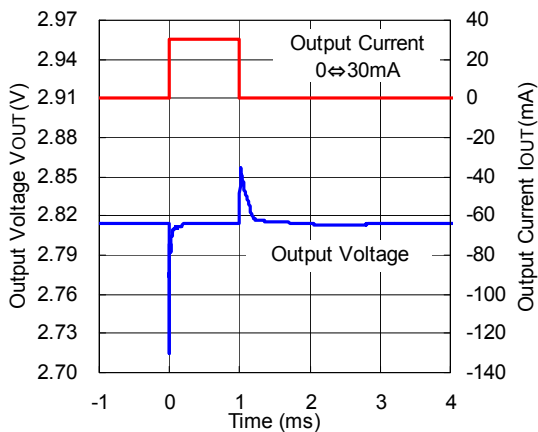

RP202x40xx

(Auto ECO Low Power Mode↔FAST Mode)

V_{IN}=5.0V

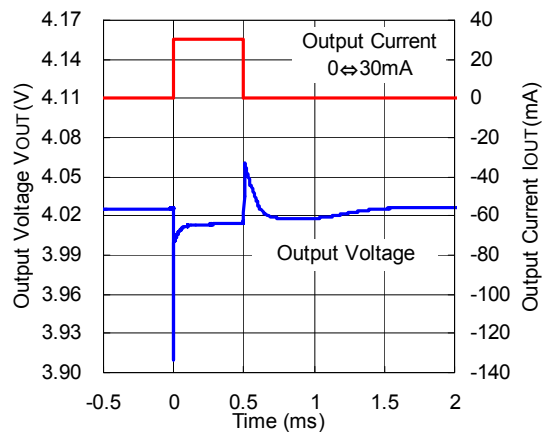

RP202x08xx
(Auto ECO FAST Mode)

V_{IN}=1.8V

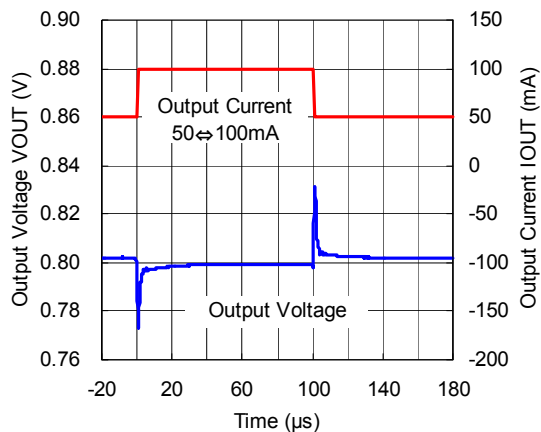

RP202x18xx
(Auto ECO FAST Mode)

V_{IN}=2.8V

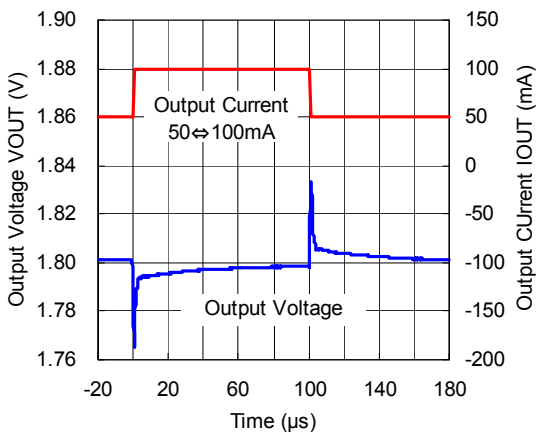

RP202x28xx
(Auto ECO FAST Mode)

V_{IN}=3.8V

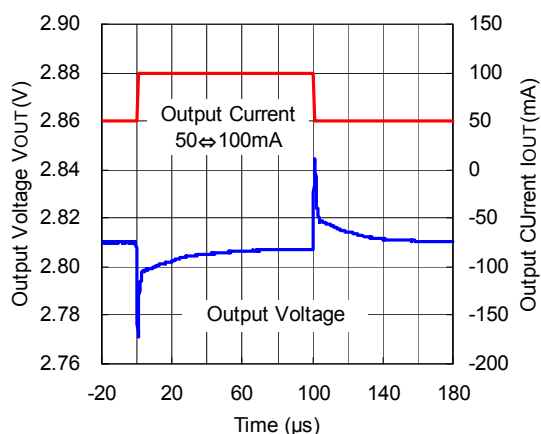

RP202x40xx
(Auto ECO FAST Mode)

V_{IN}=5.0V

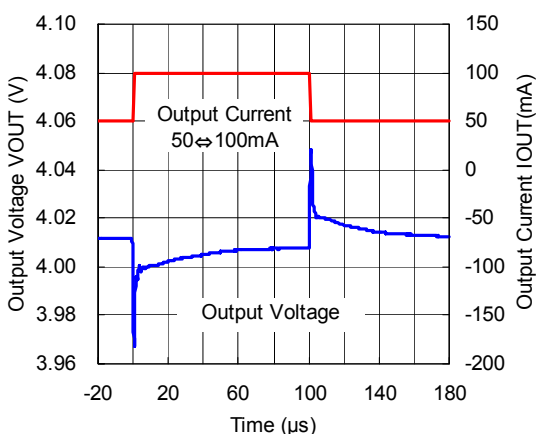

RP202x08xx
(Auto ECO Low Power Mode⇒FAST Mode)

V_{IN}=1.8V

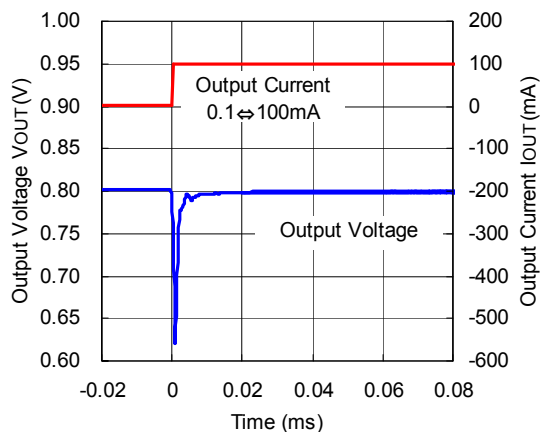

RP202x18xx
(Auto ECO Low Power Mode⇒FAST Mode)

V_{IN}=2.8V

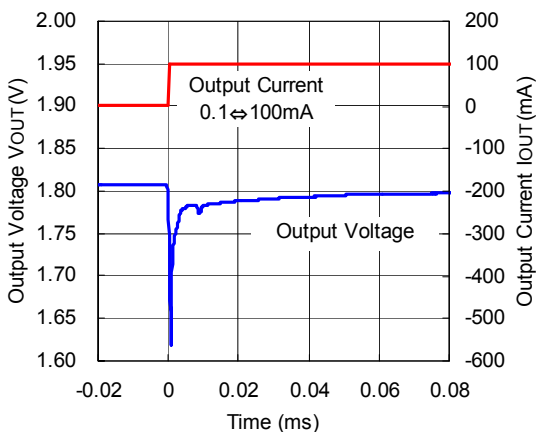

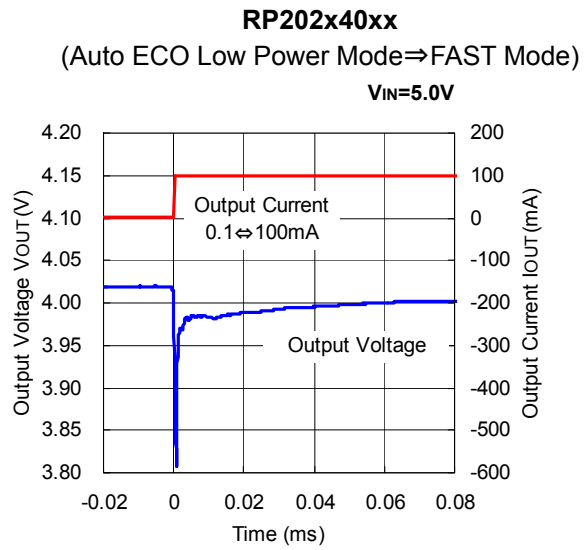
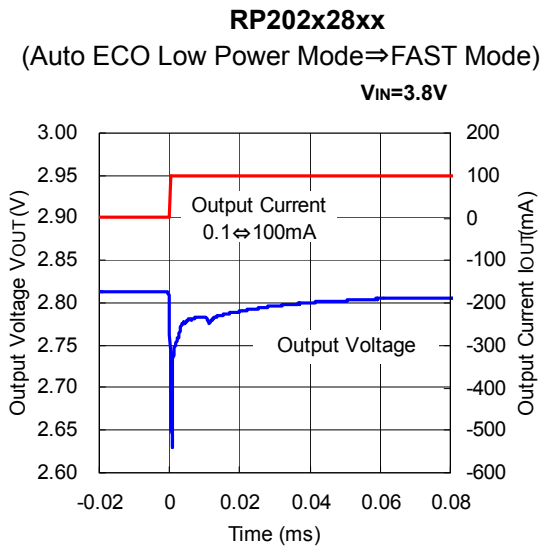

14) Turn On Waveform (Output Voltage) with CE pin (C1=0.47μF, T_a=25°C)

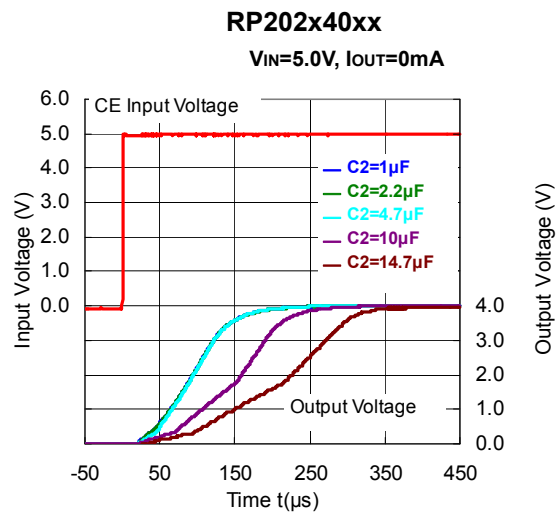
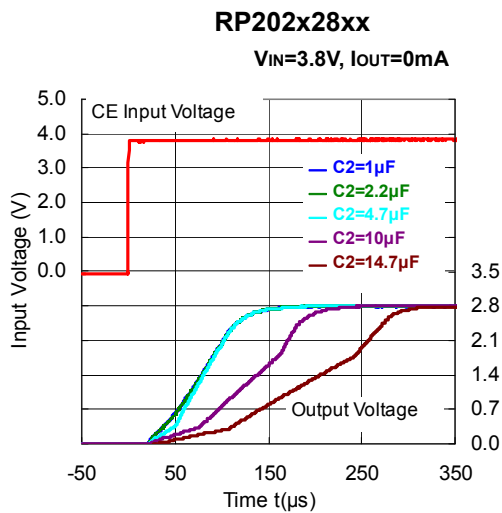
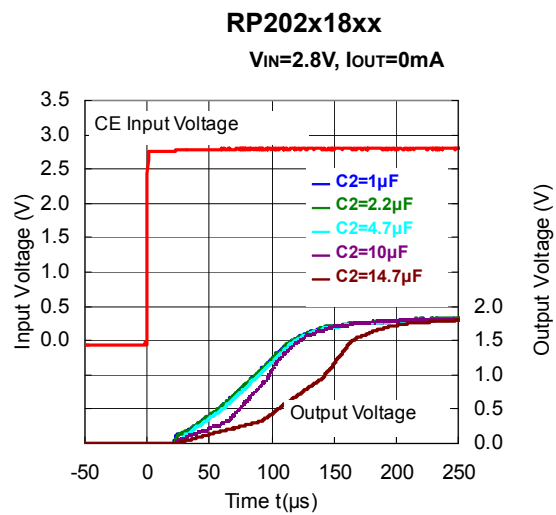
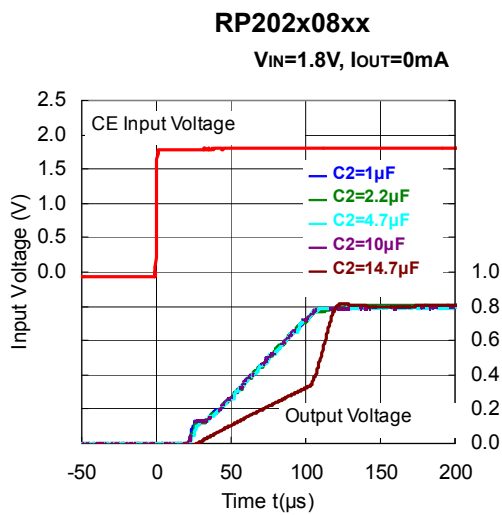

15) Turn On Input Waveform (Input Current) with CE pin (C1=0.47μF, Ta=25°C)

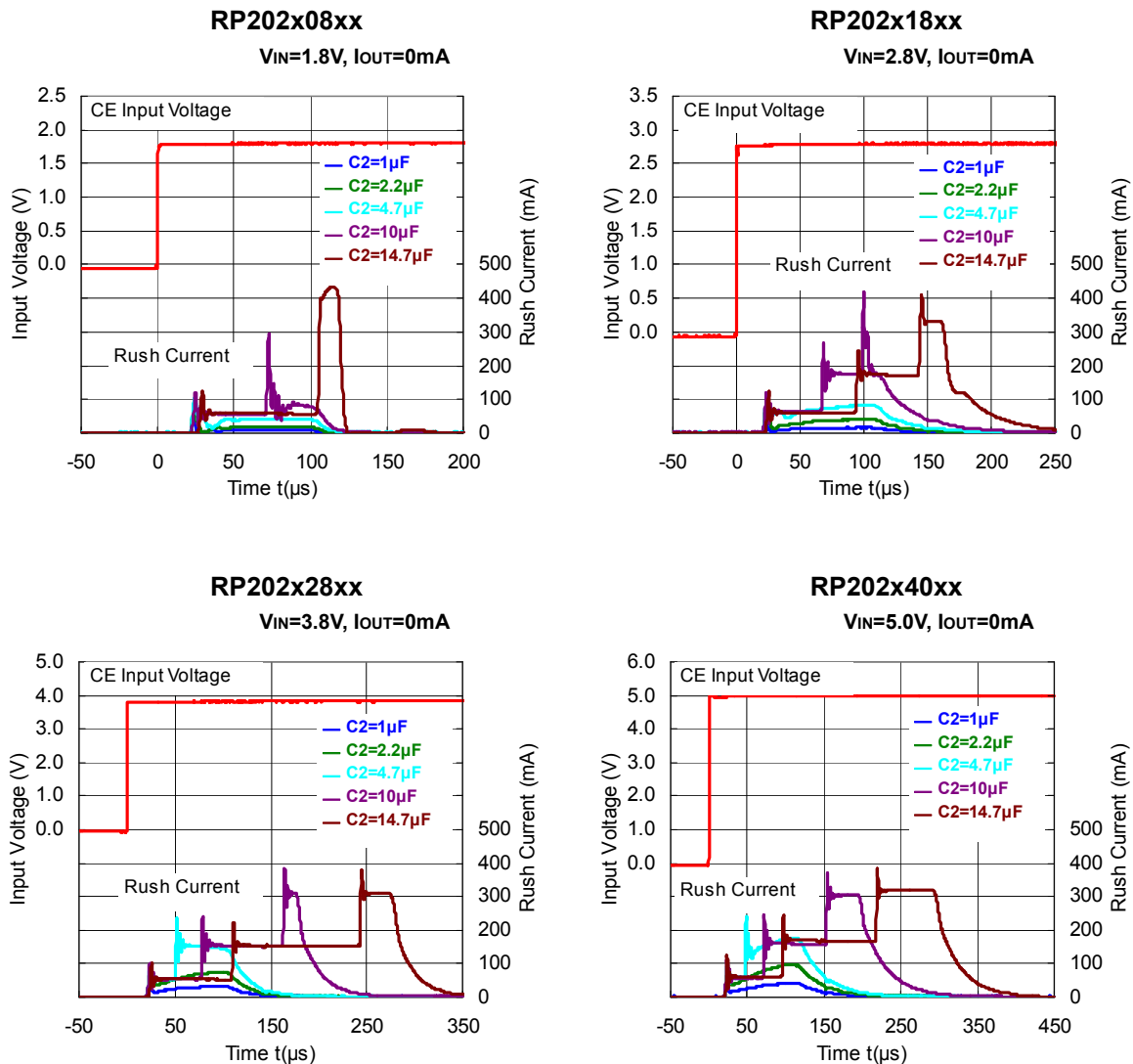

16) Turn On Speed with CE pin (D Version) (C1=0.47μF, C2=0.47μF, Ta=25°C)

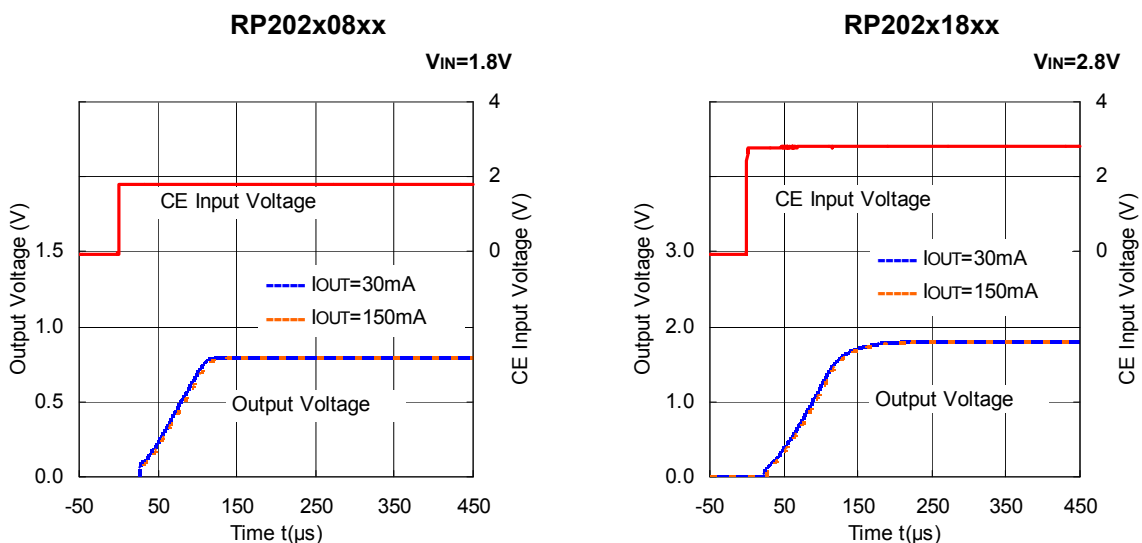

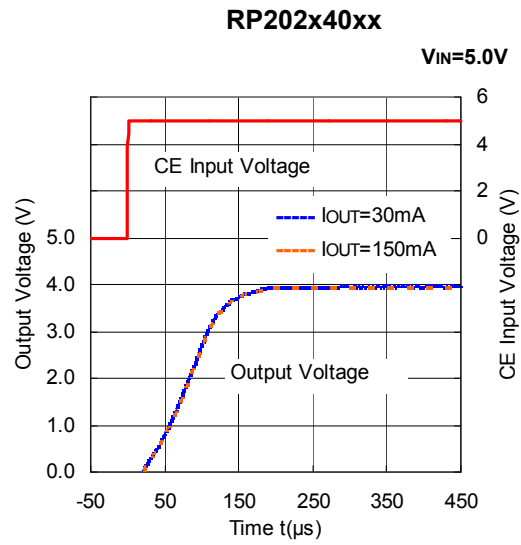
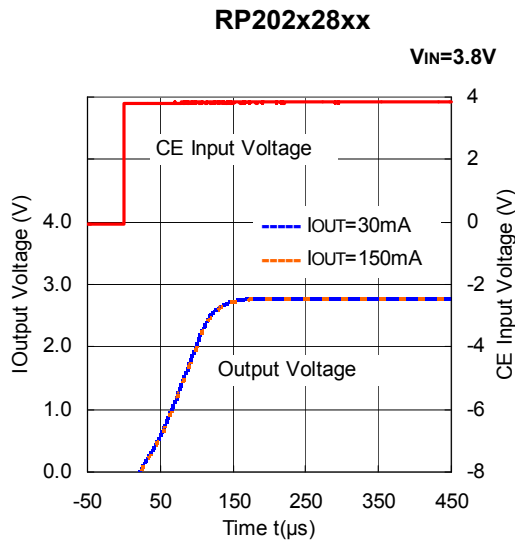

17) Turn Off Speed with CE pin (D Version) ($C1=0.47\mu F$, $C2=0.47\mu F$, $T_a=25^\circ C$)

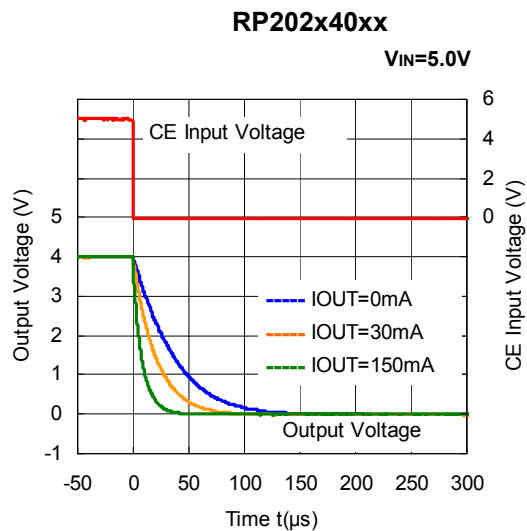
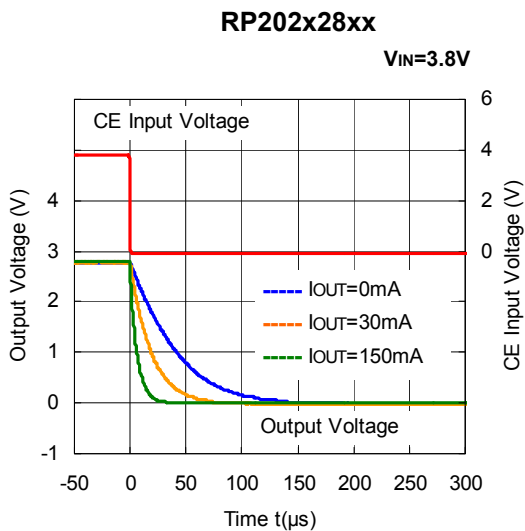
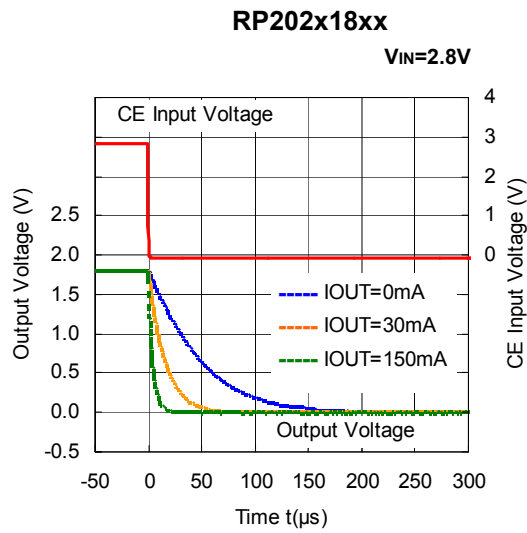
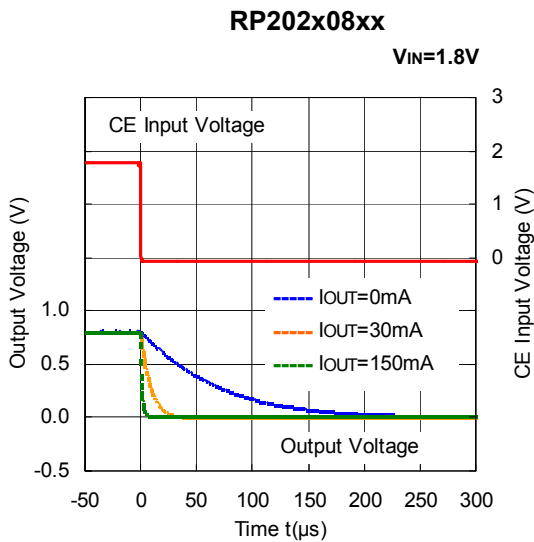

ESR vs. Output Current

When using these ICs, consider the following points:

The relations between I_{OUT} (Output Current) and ESR of an output capacitor are shown below.

The conditions when the white noise level is under $40\mu\text{V}$ (Avg.) are marked as the hatched area in the graph.

Measurement conditions

Frequency Band: 10Hz to 2MHz

Temperature : -40°C to 85°C

C1, C2 : $0.47\mu\text{F}$

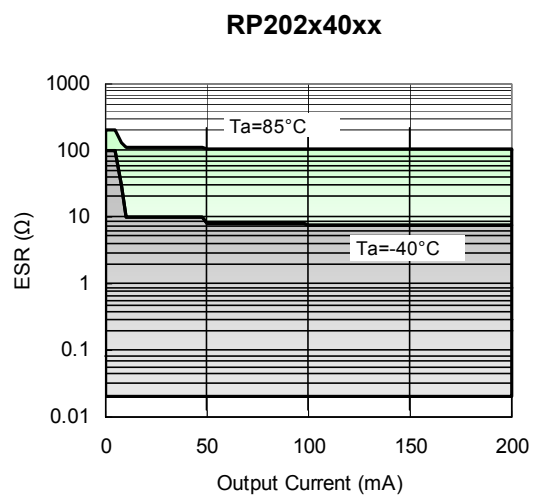
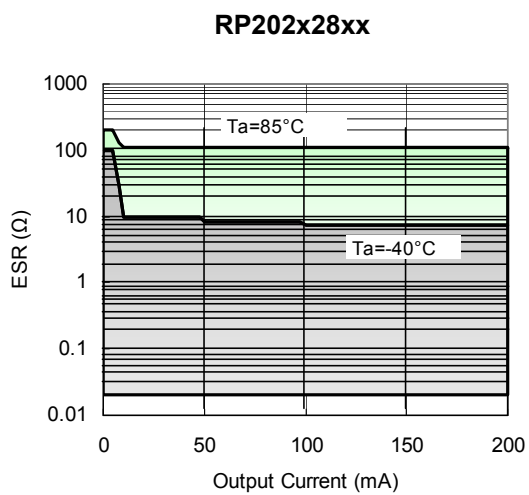
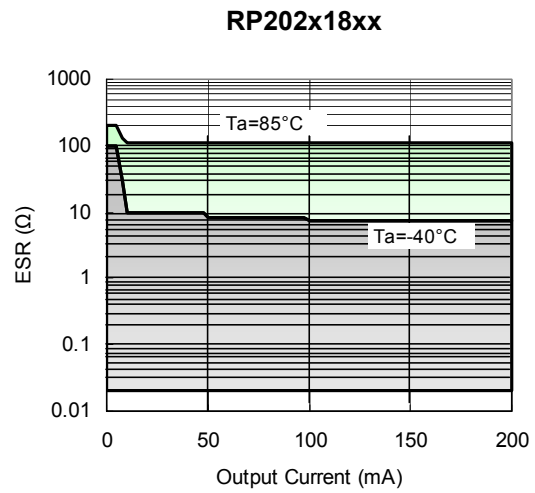
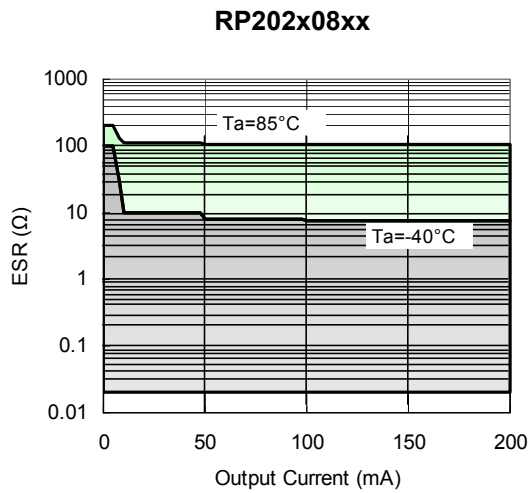



1. The products and the product specifications described in this document are subject to change or discontinuation of production without notice for reasons such as improvement. Therefore, before deciding to use the products, please refer to Ricoh sales representatives for the latest information thereon.
2. The materials in this document may not be copied or otherwise reproduced in whole or in part without prior written consent of Ricoh.
3. Please be sure to take any necessary formalities under relevant laws or regulations before exporting or otherwise taking out of your country the products or the technical information described herein.
4. The technical information described in this document shows typical characteristics of and example application circuits for the products. The release of such information is not to be construed as a warranty of or a grant of license under Ricoh's or any third party's intellectual property rights or any other rights.
5. The products listed in this document are intended and designed for use as general electronic components in standard applications (office equipment, telecommunication equipment, measuring instruments, consumer electronic products, amusement equipment etc.). Those customers intending to use a product in an application requiring extreme quality and reliability, for example, in a highly specific application where the failure or misoperation of the product could result in human injury or death (aircraft, spacevehicle, nuclear reactor control system, traffic control system, automotive and transportation equipment, combustion equipment, safety devices, life support system etc.) should first contact us.
6. We are making our continuous effort to improve the quality and reliability of our products, but semiconductor products are likely to fail with certain probability. In order to prevent any injury to persons or damages to property resulting from such failure, customers should be careful enough to incorporate safety measures in their design, such as redundancy feature, fire containment feature and fail-safe feature. We do not assume any liability or responsibility for any loss or damage arising from misuse or inappropriate use of the products.
7. Anti-radiation design is not implemented in the products described in this document.
8. Please contact Ricoh sales representatives should you have any questions or comments concerning the products or the technical information.



Ricoh is committed to reducing the environmental loading materials in electrical devices with a view to contributing to the protection of human health and the environment.

Ricoh has been providing RoHS compliant products since April 1, 2006 and Halogen-free products since April 1, 2012.

RICOH RICOH ELECTRONIC DEVICES CO., LTD.

<http://www.e-devices.ricoh.co.jp/en/>

Sales & Support Offices

RICOH ELECTRONIC DEVICES CO., LTD.

Higashi-Shinagawa Office (International Sales)
3-32-3, Higashi-Shinagawa, Shinagawa-ku, Tokyo 140-8655, Japan
Phone: +81-3-5479-2857 Fax: +81-3-5479-0502

RICOH EUROPE (NETHERLANDS) B.V.

Semiconductor Support Centre
Prof. W.H. Keesomlaan 1, 1183 DJ Amstelveen, The Netherlands
Phone: +31-20-5474-309

RICOH INTERNATIONAL B.V. - German Branch

Semiconductor Sales and Support Centre
Oberrather Strasse 6, 40472 Düsseldorf, Germany
Phone: +49-211-6546-0

RICOH ELECTRONIC DEVICES KOREA CO., LTD.

3F, Haesung Bldg, 504, Teheran-ro, Gangnam-gu, Seoul, 135-725, Korea
Phone: +82-2-2135-5700 Fax: +82-2-2051-5713

RICOH ELECTRONIC DEVICES SHANGHAI CO., LTD.

Room 403, No.2 Building, No.690 Bibo Road, Pu Dong New District, Shanghai 201203, People's Republic of China
Phone: +86-21-5027-3200 Fax: +86-21-5027-3299

RICOH ELECTRONIC DEVICES CO., LTD.

Taipei office
Room 109, 10F-1, No.51, Hengyang Rd., Taipei City, Taiwan (R.O.C.)
Phone: +886-2-2313-1621/1622 Fax: +886-2-2313-1623

Mouser Electronics

Authorized Distributor

Click to View Pricing, Inventory, Delivery & Lifecycle Information:

[Ricoch Electronics:](#)

[RP202K291D5-TR](#) [RP202K281D5-TR](#) [RP202K311D-TR](#) [RP202K181D5-TR](#)



Компания «ЭлектроПласт» предлагает заключение долгосрочных отношений при поставках импортных электронных компонентов на взаимовыгодных условиях!

Наши преимущества:

- Оперативные поставки широкого спектра электронных компонентов отечественного и импортного производства напрямую от производителей и с крупнейших мировых складов;
- Поставка более 17-ти миллионов наименований электронных компонентов;
- Поставка сложных, дефицитных, либо снятых с производства позиций;
- Оперативные сроки поставки под заказ (от 5 рабочих дней);
- Экспресс доставка в любую точку России;
- Техническая поддержка проекта, помощь в подборе аналогов, поставка прототипов;
- Система менеджмента качества сертифицирована по Международному стандарту ISO 9001;
- Лицензия ФСБ на осуществление работ с использованием сведений, составляющих государственную тайну;
- Поставка специализированных компонентов (Xilinx, Altera, Analog Devices, Intersil, Interpoint, Microsemi, Aeroflex, Peregrine, Syfer, Eurofarad, Texas Instrument, Miteq, Cobham, E2V, MA-COM, Hittite, Mini-Circuits, General Dynamics и др.);

Помимо этого, одним из направлений компании «ЭлектроПласт» является направление «Источники питания». Мы предлагаем Вам помощь Конструкторского отдела:

- Подбор оптимального решения, техническое обоснование при выборе компонента;
- Подбор аналогов;
- Консультации по применению компонента;
- Поставка образцов и прототипов;
- Техническая поддержка проекта;
- Защита от снятия компонента с производства.



Как с нами связаться

Телефон: 8 (812) 309 58 32 (многоканальный)

Факс: 8 (812) 320-02-42

Электронная почта: org@eplast1.ru

Адрес: 198099, г. Санкт-Петербург, ул. Калинина, дом 2, корпус 4, литера А.