

LOC	DIST	REVISIONS					
		P	LTN	DESCRIPTION	DATE	DWN	APVD
ES	00	G9		ADD NEW DASH NUMBER 2-9	04MAY2012	CZ	SZ
		H2		REV PER ECR-12-020199	22NOV2012	CZ	SZ
		H4		ADDED THE NEW DASH NUMBER -33	28DEC2012	ML	SZ

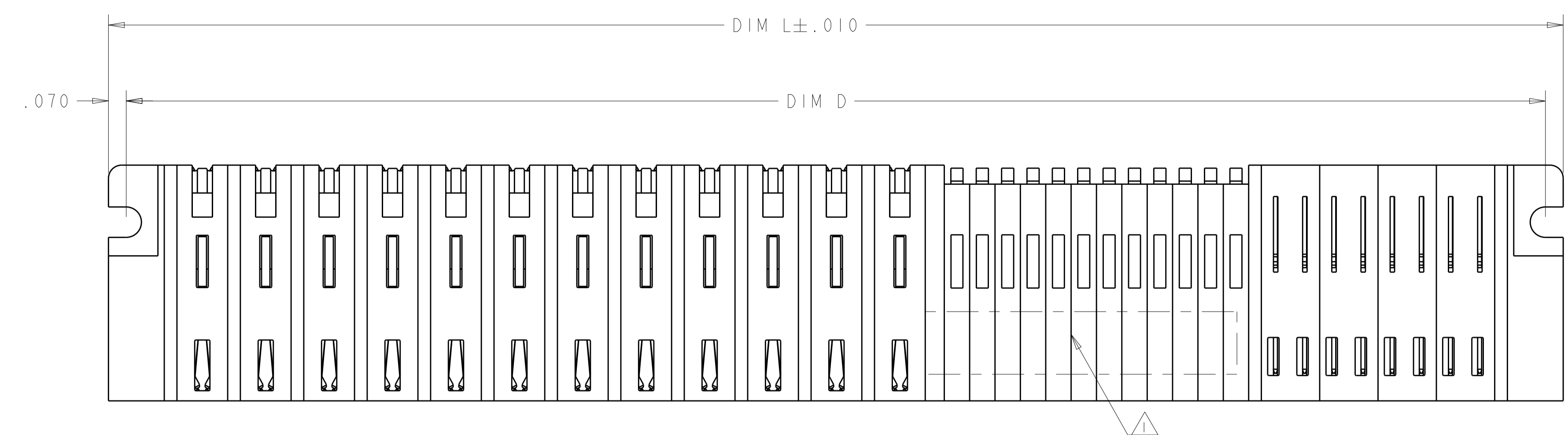

- 1 "AMP", PART NUMBER, AND DATECODE TO BE MARKED IN AREA SHOWN. PARTS UNDER 2.00 LONG MAY BE MARKED ON BOTH SIDES.
- 2 MATERIAL:  
HOUSING - GLASS FILLED HIGH TEMP THERMO PLASTIC, BLACK, UL94 V-0  
SIGNAL CONTACT - COPPER ALLOY  
POWER CONTACT - HIGH CONDUCTIVITY COPPER ALLOY.
- 3 CONTACT PLATING - NOBLE METAL PLATING ON CONTACT FUNCTIONAL AREA OF POWER AND SIGNAL CONTACTS
- 4 MECHANICAL CONNECTOR KEEP OUT ZONE.
- 5 DATUM AND BASIC DIMENSIONS ESTABLISHED BY CUSTOMER.
- 6 PCB - HOLE DIAMETERS ARE FINISHED HOLE SIZE.
- 7 PCB - .0453±.0010 DRILLED HOLES PLATED WITH .0003 MIN Sn OVER .001 TO .003 Cu PLATING TO ACHIEVE A .040 DIA HOLE.
- 8 TO GENERAL POWER CONTACT (WITHOUT LP POWER CONTACT), VARIABLE DIMENSIONS PLEASE SEE SHEET 2.
- 9 PLEASE REFER TO PAGE 5 FOR DETAIL DIMENSIONS.
- 10 PLEASE REFER TO PAGE 7 FOR SPECIAL DIMENSIONS.
- 11 FOR LP/S/P CONFIGURATION, OR SPECIAL DIMENSIONS FOR PART 2-6450840-1, PLEASE REFER TO SHEET 2.

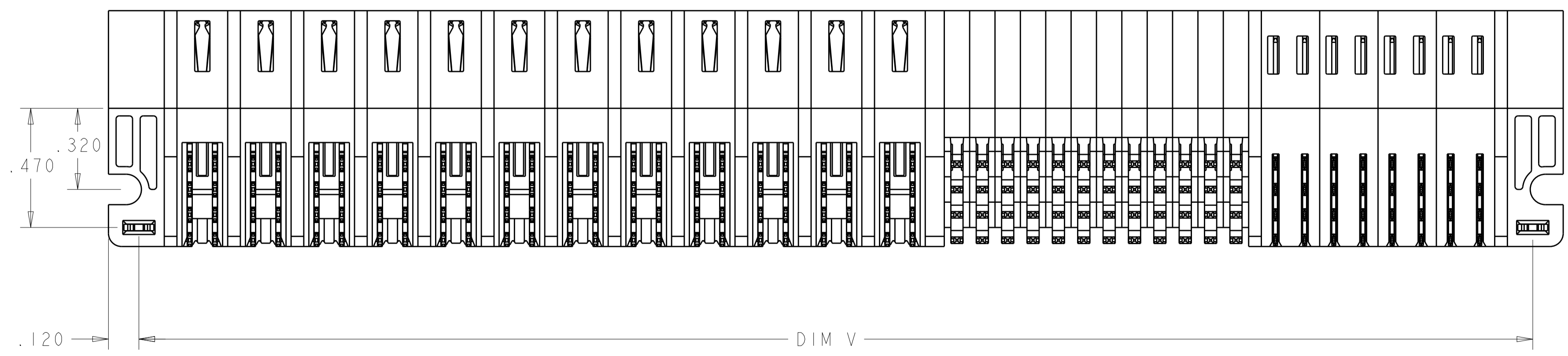
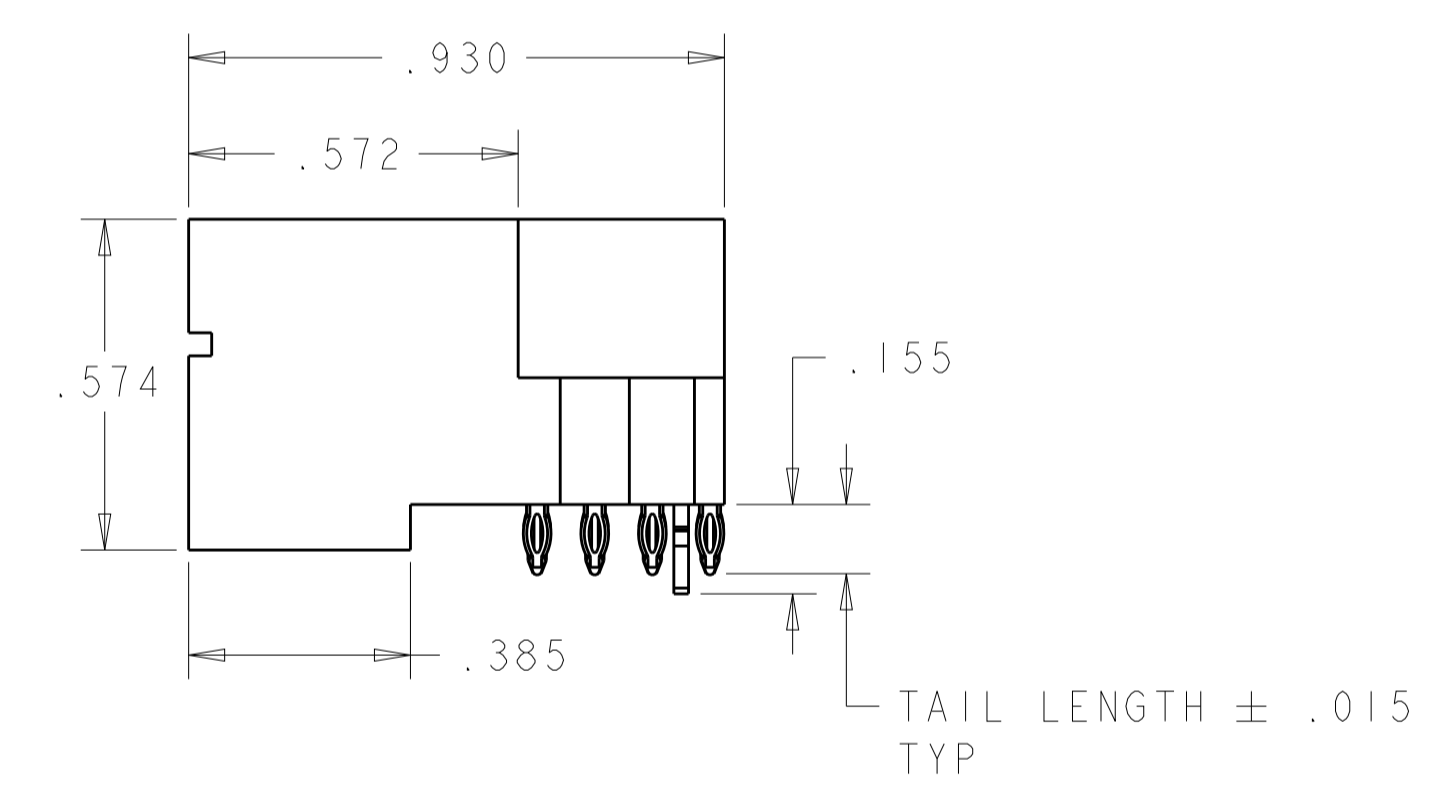
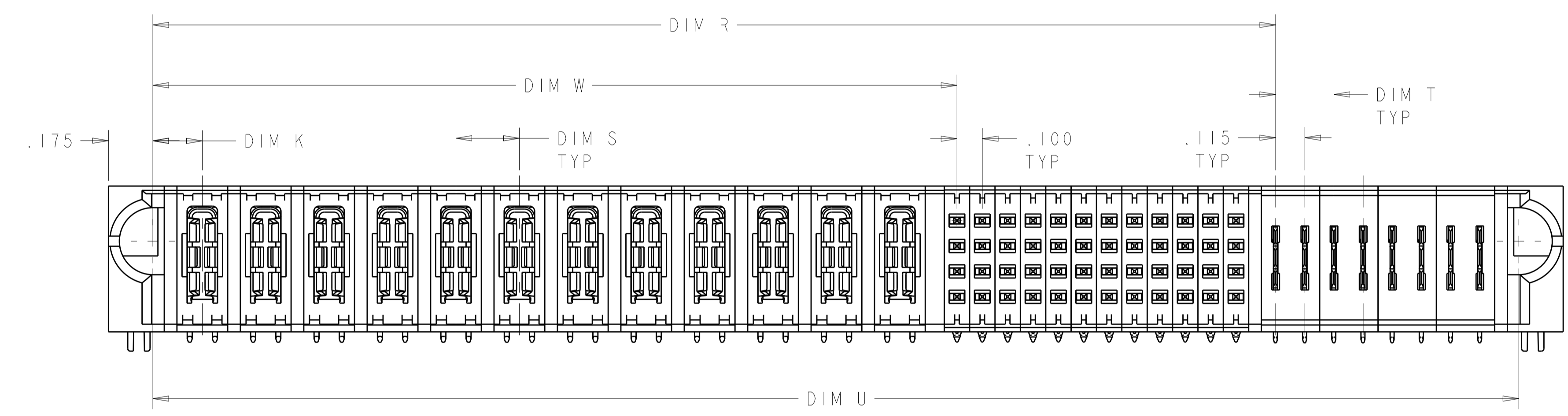

THIS DRAWING IS A CONTROLLED DOCUMENT.		DWN ALEX SHOAL CHK Sunny Zhao	14DEC2007 20DEC2007	<b>TE</b> Connectivity
DIMENSIONS: INCHES		TOLERANCES UNLESS OTHERWISE SPECIFIED: 0 PLC ±. 2 PLC ±.01 3 PLC ±.005 4 PLC ±.0050 ANGLES ±°	APVD Sunny Zhao 20DEC2007	
MATERIAL: 2		FINISH: 3	PRODUCT SPEC 108-2292 APPLICATION SPEC 114-13251 WEIGHT Customer Drawing	SIZE A100779 CAGE CODE 6450840 SCALE 4:1
4805 (3/11)		SHEET 1 OF 16		REV H4

THIS DRAWING IS UNPUBLISHED. RELEASED FOR PUBLICATION 20  
 © COPYRIGHT 20 BY TE CONNECTIVITY ALL RIGHTS RESERVED.

LOC	DIST	REVISIONS					
		P	LTN	DESCRIPTION	DATE	DWN	APVD
ES	00	-		SEE SHEET 1	-	-	-

H3	.250	2.315	1.535	.860	2.205	.230	2.415	2.555	.1275	6LP + 24S + 3P	3-6450840-3
H2	-	1.135	.8075	.375	1.025	-	1.235	1.375	.1025	2LP + 16S + 2LP	3-6450840-1
	.250	2.300	1.520	.845	2.190	.250	2.400	2.540	.170	3P + 24S + 3P	2-6450840-9
	.250	3.800	2.270	1.595	3.690	.250	3.900	4.040	.170	6P + 24S + 6P	2-6450840-7
	.250	4.400	2.370	2.095	4.290	.250	4.500	4.640	.170	8P + 8S + 8P	1-6450840-6
	.250	1.700	1.145	.645	1.590	.250	1.800	1.940	.195	2P + 16S + 2P	2-6450840-5
	.250	6.000	3.970	2.095	5.890	.250	6.100	6.240	.170	8P + 72S + 8P	2-6450840-3
	.250	2.500	1.470	1.095	2.390	.250	2.600	2.740	.170	4P + 12S + 4P	2-6450840-2
	.230	5.585	1.5025	.645	5.475	.250	5.685	5.825	.170	2P + 32S + 4LP + 14P	2-6450840-1
	.250	3.520	2.990	2.265	3.410	.230	3.620	3.760	.1525	18LP + 24S + 2P	2-6450840-0
	-	1.300	1.020	.345	1.190	-	1.400	1.540	.170	1P + 24S + 1P	1-6450840-5
	.200	3.300	2.020	1.345	3.190	.200	3.400	3.540	.170	6HDP + 24S + 6HDP	1-6450840-2
	.200	2.400	1.520	.945	2.290	.200	2.500	2.640	.170	4HDP + 20S + 4HDP	1-6450840-1
	.250	2.400	1.370	1.095	2.290	.250	2.500	2.640	.170	4P + 8S + 4P	1-6450840-0
	.200	2.100	1.220	.945	1.990	.200	2.200	2.340	.170	4HDP + 8S + 4HDP	6450840-9
	-	-	-	-	-	-	-	-	-	4P+16S+24S+2HDP	6450840-8
	-	1.300	1.020	.345	1.190	-	1.400	1.540	.170	1P + 24S + 1P	6450840-7
	-	2.480	2.1525	1.345	2.370	.250	2.580	2.720	.170	5P + 32S + 2LP	6450840-6
	.250	3.400	2.120	1.395	3.290	.250	3.500	3.640	.170	5P + 24S + 5P	6450840-5
	.200	5.150	2.670	1.345	5.040	.300	5.250	5.390	.195	4ACP + 48S + 12HDP	6450840-4
	.230	5.495	4.4275	3.170	5.385	.250	5.595	5.735	.195	12P + 48S + 8LP	6450840-3
	-	2.315	-	-	2.205	-	2.415	2.555	.170	3P+ 1LP + 24S + 3HDP	6450840-2
	DIM T	DIM V	DIM R	DIM W	DIM U	DIM S	DIM D	DIM L	DIM K	DESCRIPTION	PART NUMBER

THIS DRAWING IS A CONTROLLED DOCUMENT.		DWN ALEX SHOAL CHK Sunny Zhao	14DEC2007 20DEC2007		TE Connectivity
DIMENSIONS: INCHES		TOLERANCES UNLESS OTHERWISE SPECIFIED: 0 PLC ±. 2 PLC ±.01 3 PLC ±.005 4 PLC ±.0050 ANGLES ±.0°	APVD Sunny Zhao Z0DEC2007		NAME RIGHT ANGLE HEADER W/ LP CONTACT AND SHORT END MODULES MULTI-BEAM XLE
MATERIAL		FINISH	PRODUCT SPEC 108-2292	SIZE A100779	CAGE CODE 6450840
			APPLICATION SPEC 114-13251	SCALE 1:1	SHEET 2 OF 16
			WEIGHT	REV H4	
			Customer Drawing		

LOC		DIST		REVISIONS			
ES	00	P	LTH	DESCRIPTION	DATE	DMN	APVD
		-		SEE SHEET 1			

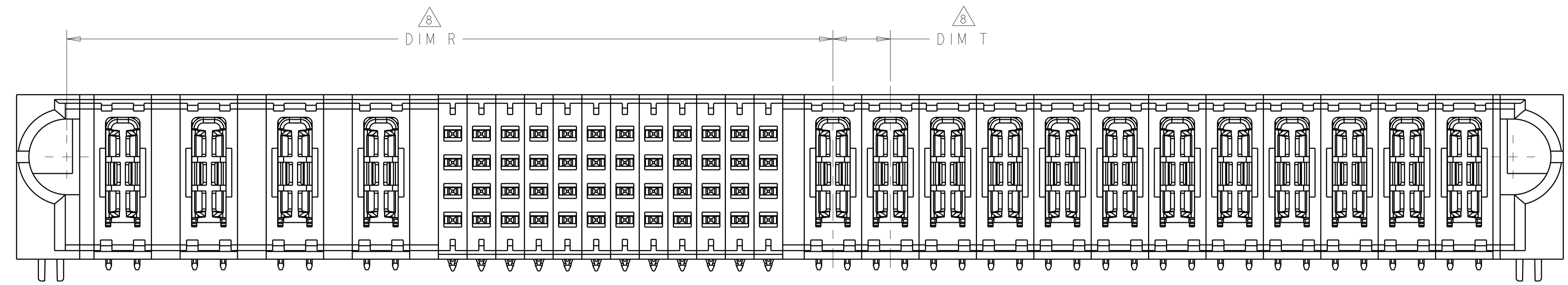

FOR P/S/P CONFIGURATION  
 UNSPECIFIED DIM REFER TO SHEET 1  
 SCALE 4:1

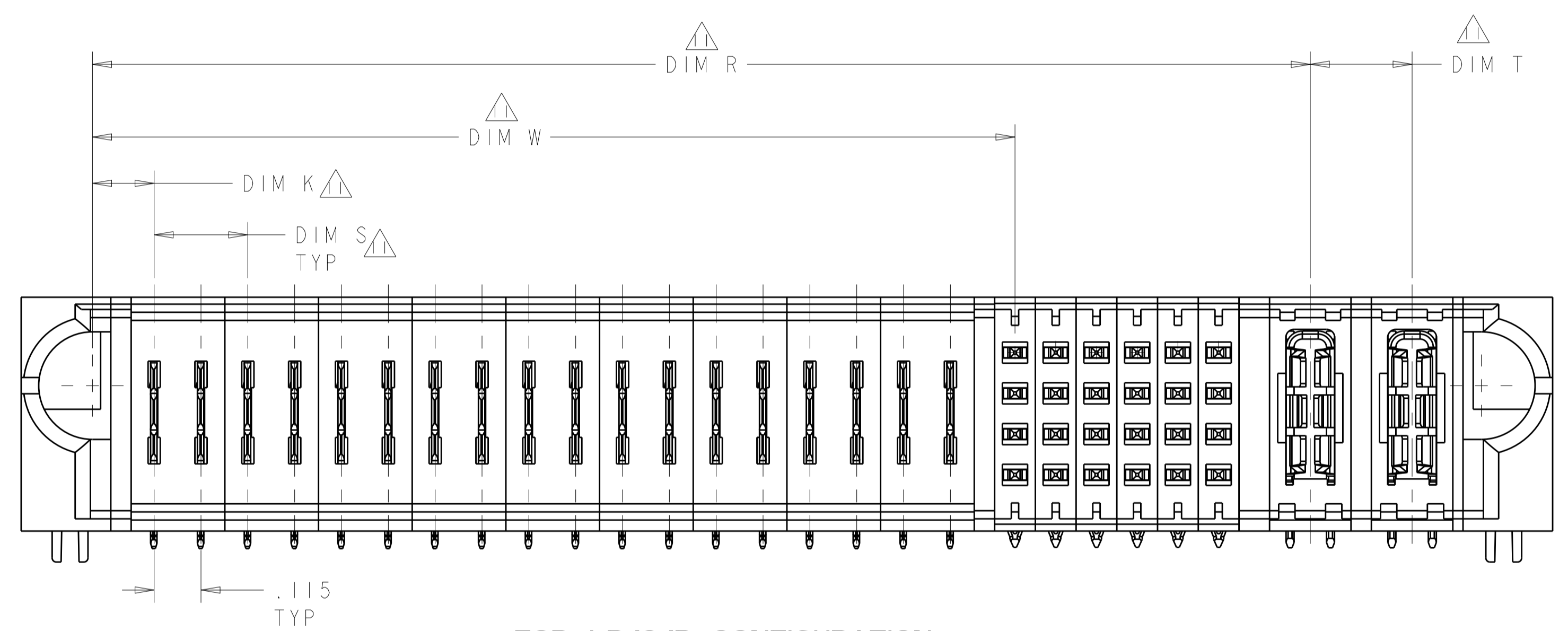

FOR LP/S/P CONFIGURATION  
 UNSPECIFIED DIM REFER TO SHEET 1

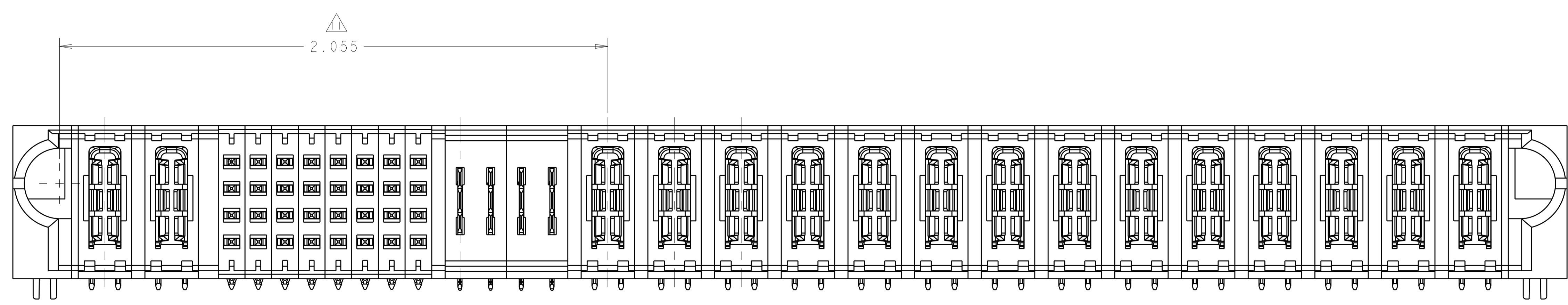

FOR PART 2-6450840-1 ONLY

THIS DRAWING IS A CONTROLLED DOCUMENT.		DMN: ALEX SHOAL 14DEC2007	 TE Connectivity NAME: RIGHT ANGLE HEADER W/ LP CONTACT AND SHORT END MODULES MULTI-BEAM XLE
DIMENSIONS: INCHES		CHK: Sunny Zhao 20DEC2007	
TOLERANCES UNLESS OTHERWISE SPECIFIED:		APVD: Sunny Zhao 20DEC2007	
0 PLC ±. 1 PLC ±.01 2 PLC ±.01 3 PLC ±.005 4 PLC ±.0050 ANGLES ±.0°		PRODUCT SPEC: 108-2292 APPLICATION SPEC: 114-13251 WEIGHT: - FINISH: -	
MATERIAL: -		SIZE: A100779	CAGE CODE: C=6450840 CUSTOMER DRAWING: - SCALE: 1:1 SHEET 3 OF 16 REV: H4





LOC	DIST	REV	DATE	APPD
ES	00			

PART NUMBER	ROWS	POWER	SIGNAL						POWER		
			P1	1	2	3	4	5		6	P2
6450840-7	D C B A	TT	HD	Z5	Z5	Z5	Z5	Z5	Z5	TT	HD
				Y5	Y5	Y5	Y5	Y5	Y5		
				R5	R5	R5	R1	R5	R5		
				O5	O5	O5	O5	O5	O5		
IP + 24S + IP											

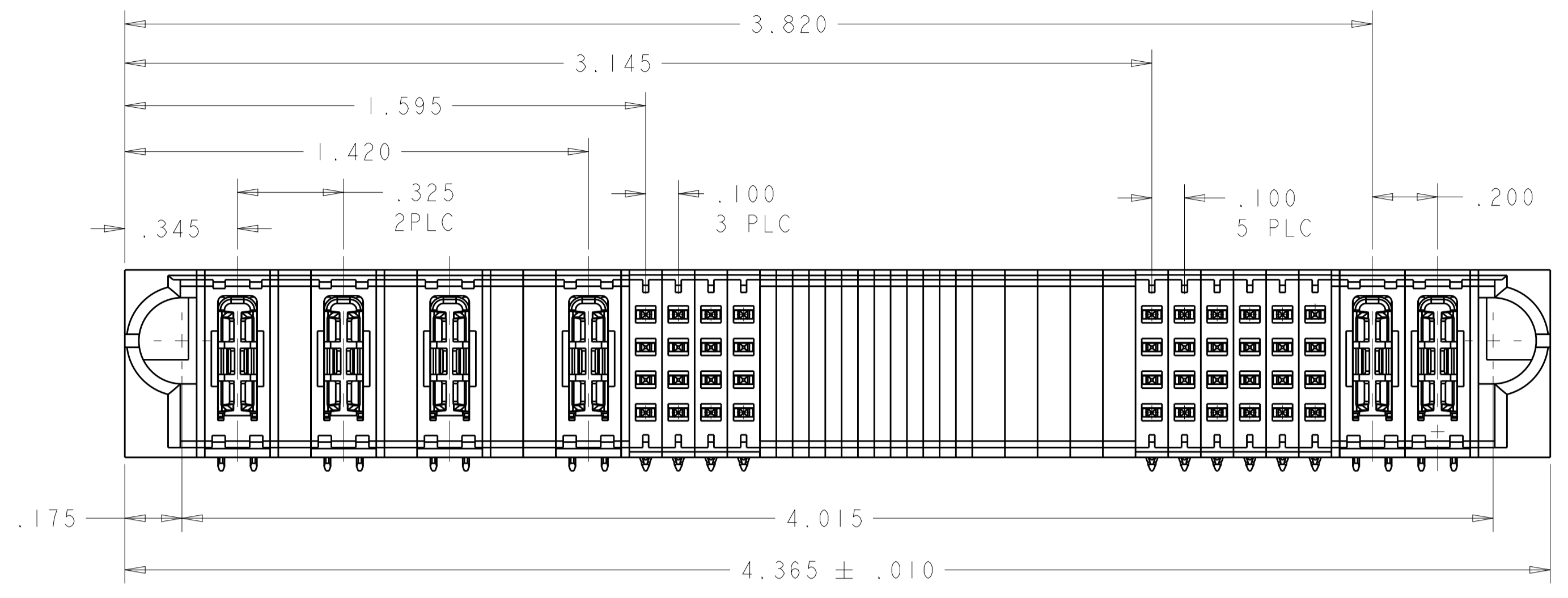

PART NUMBER: 6450840-8

PART NUMBER	ROWS	POWER	SIGNAL				BLANK	SIGNAL				POWER	
			P1	P2	P3	P4		5	6	7	8		9
6450840-8	D C B A	TT	TT	TT	TT	TT	BLANK	Z5	Z5	Z5	Z5	TT	TT
								Y5	Y5	Y5	Y5		
								R5	R5	R5	R5		
								O5	O5	O5	O5		
4P + 16S + 24S + 2HDP													

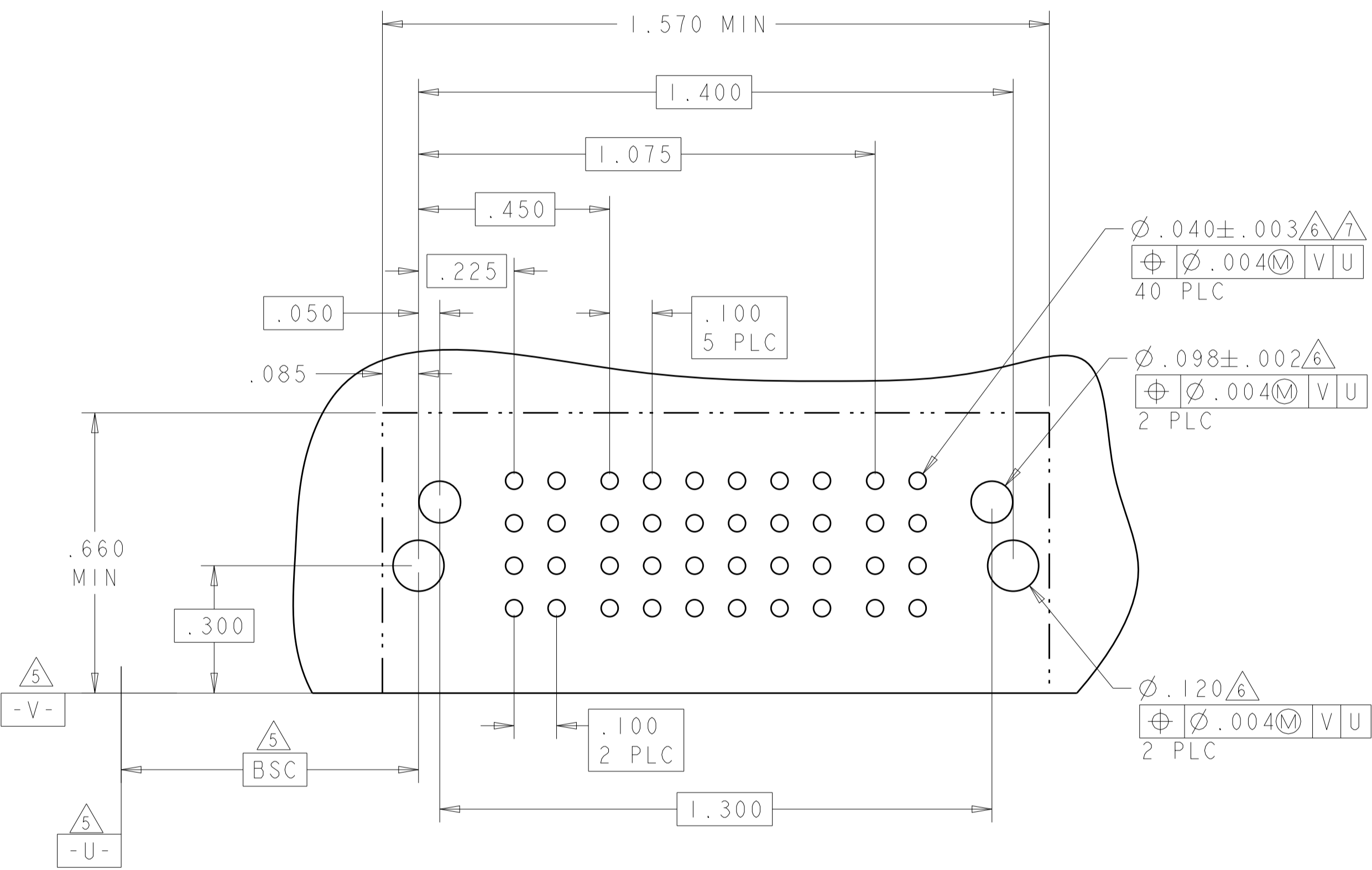

PART NUMBER	ROWS	POWER	SIGNAL						POWER		
			P1	1	2	3	4	5		6	P2
1-6450840-5	D C B A	TT	HD	Z5	Z5	Z5	Z5	Z5	Z5	TT	HD
				Y5	Y5	Y5	Y5	Y5	Y5		
				R5	R5	R5	R5	R5	R5		
				O5	O5	O1	O5	O5	O5		
IP + 24S + IP											

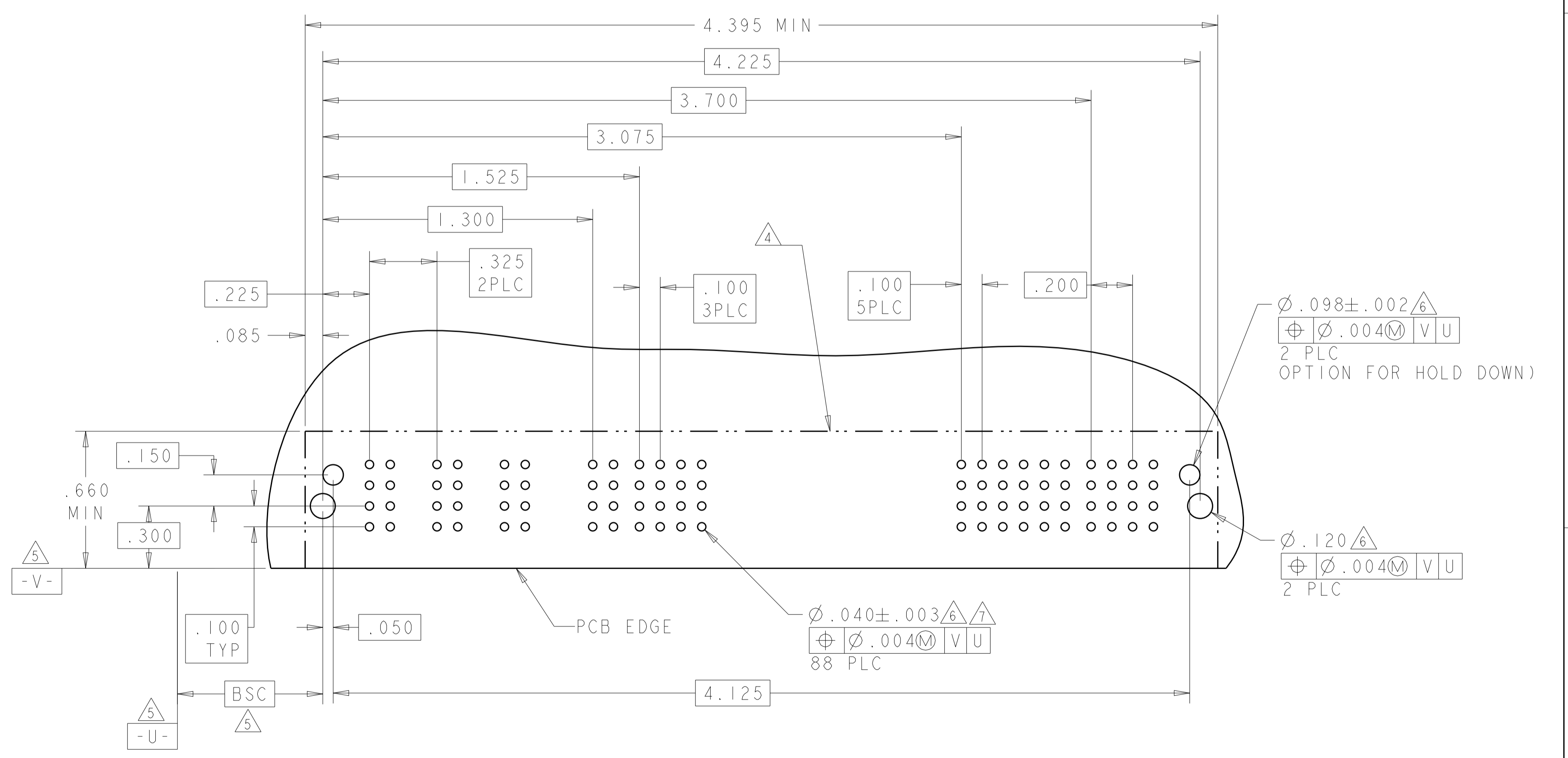

LAYOUT OF 1-6450840-5 IS SAME AS 6450840-7.

THIS DRAWING IS A CONTROLLED DOCUMENT.		OWN: ALEX SHOAL 14DEC2007	TE Connectivity
DIMENSIONS: INCHES		CHK: Sunny Zhao 20DEC2007	
TOLERANCES UNLESS OTHERWISE SPECIFIED:		APVD: Sunny Zhao 20DEC2007	NAME: RIGHT ANGLE HEADER W/ LP CONTACT AND SHORT END MODULES MULTI-BEAM XLE
0 PLC ±. 1 PLC ±.01 2 PLC ±.01 3 PLC ±.005 4 PLC ±.005 ANGLES ±.0050		PRODUCT SPEC: 108-2292	SIZE: A1
MATERIAL: FINISH:		APPLICATION SPEC: 114-13251	CAGE CODE: 6450840
		WEIGHT: Customer Drawing	RESTRICTED TO: H4
		SCALE: 1:1	SHEET 6 OF 16

LOC	DIST	REV	DATE	BY	APPV
ES	00				
REVISIONS			DESCRIPTION	DATE	BY
			SEE SHEET 1		

PART NUMBER	ROWS	POWER				SIGNAL	POWER						
		P1	P2	P3	P4	1   2	P5	P6	P7	P8			
6450840-9	D C B A	HD	TT	TT	TT	TT	Z5	Z5	TT	TT	TT	TT	HD
							Y5	Y5					
							R5	R5					
							O5	O5					
4HDP + 8S + 4HDP													

PART NUMBER	ROWS	POWER				SIGNAL	POWER						
		P1	P2	P3	P4	1   2	P5	P6	P7	P8			
1-6450840-0	D C B A	HD	TT	TT	TT	TT	Z5	Z5	TT	TT	TT	TT	HD
							Y5	Y5					
							R5	R5					
							O5	O5					
4P + 8S + 4P													

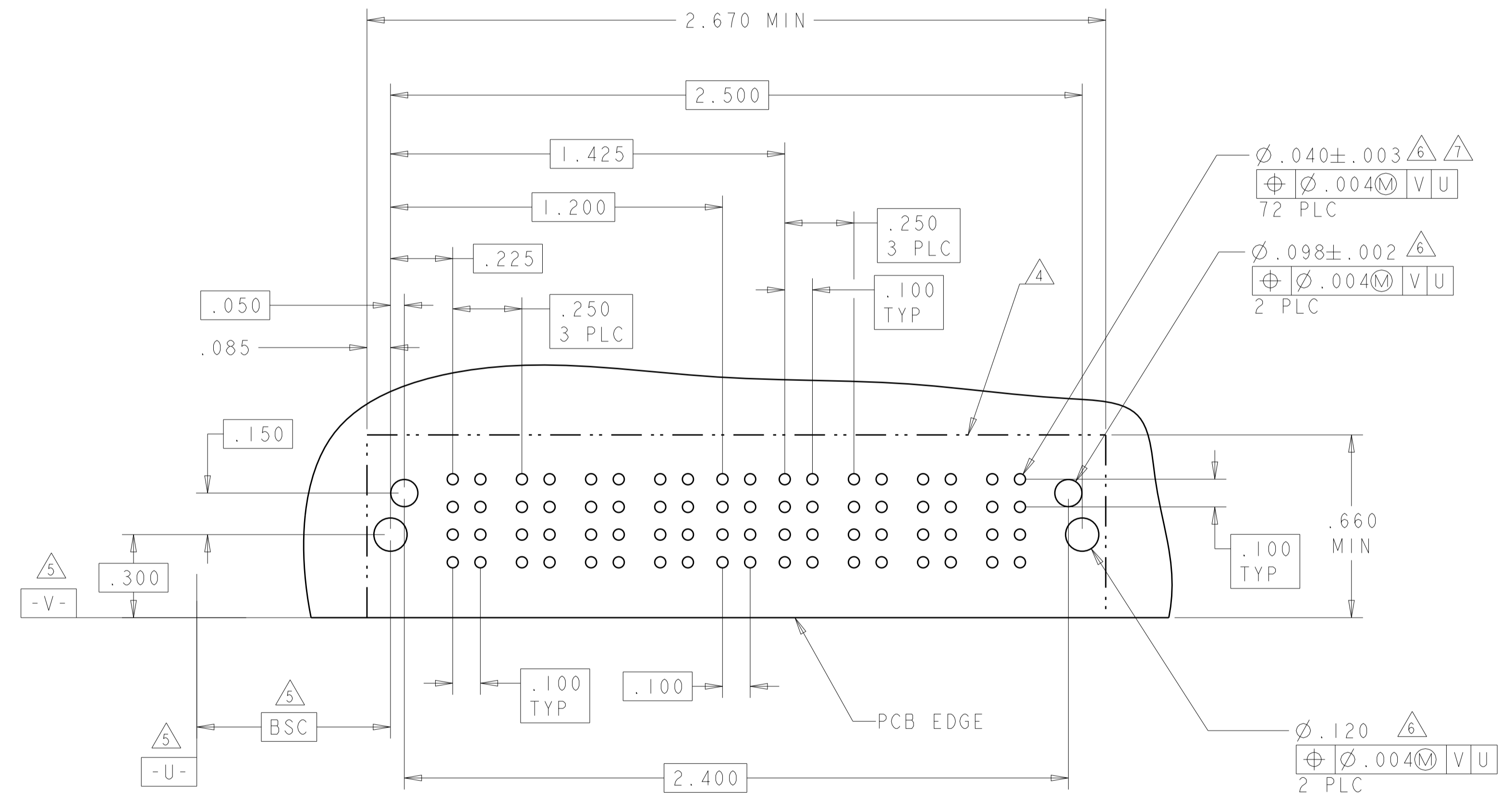
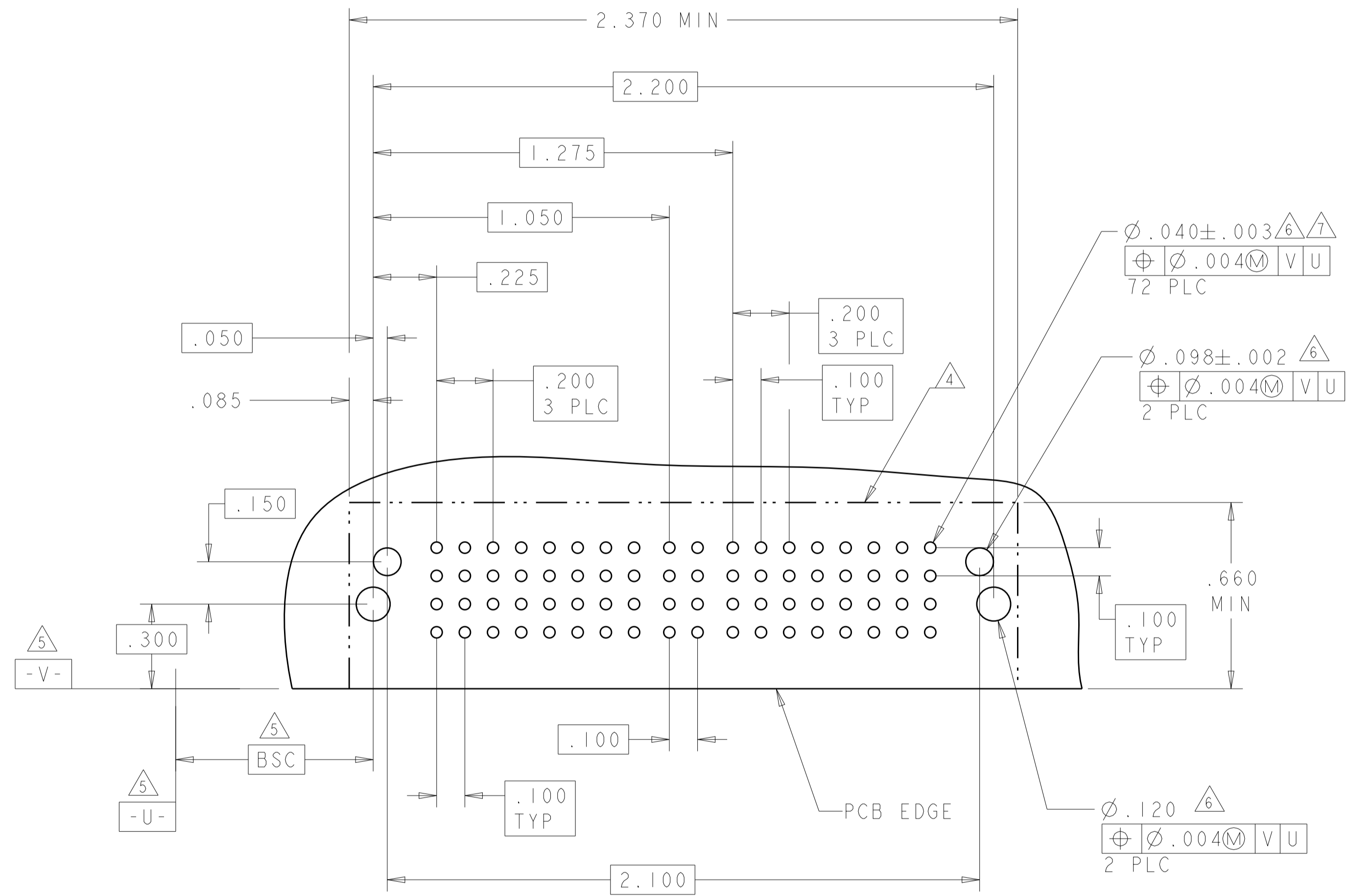

THIS DRAWING IS A CONTROLLED DOCUMENT.

DIMENSIONS: INCHES	TOLERANCES UNLESS OTHERWISE SPECIFIED: 0 PLC ±. 1 PLC ±.01 2 PLC ±.01 3 PLC ±.005 4 PLC ±.0050 ANGLES ±.7°	FINISH	FINISH
-----------------------	--	--------	--------

OWN: ALEX SHOAL	DATE: 14DEC2007	TE Connectivity
CHK: Sunny Zhao	20DEC2007	
APVD: Sunny Zhao	20DEC2007	
NAME: RIGHT ANGLE HEADER W/ LP CONTACT AND SHORT END MODULES MULTI-BEAM XLE		
PRODUCT SPEC: 108-2292	APPLICATION SPEC: 114-13251	SIZE: A1
WEIGHT: -	SCALE: 1:1	SHEET 7 OF 16
Customer Drawing		REV: H4





LOC	DIST	REVISIONS			
ES	00	REV	DATE	BY	APPD
		-	SEE SHEET 1	-	-

PART NUMBER	ROWS	POWER						SIGNAL						POWER											
		P1	P2	P3	P4	P5	P6	1	2	3	4	5	6	P7	P8	P9	P10	P11	P12						
1-6450840-2	D	TT	TT	TT	TT	TT	TT	Z5	Z5	Z5	Z5	Z5	Z5	TT	TT	TT	TT	TT	TT						
	C							Y5	Y5	Y5	Y5	Y5	Y5												
	B							R5	R5	R5	R5	R5	R5												
	A							O5	O5	O5	O5	O5	O5												
6HDP + 24S + 6HDP		HD																							

PART NUMBER	ROWS	LOW POWER																		SIGNAL						POWER	
		LP1	LP2	LP3	LP4	LP5	LP6	LP7	LP8	LP9	LP10	LP11	LP12	LP13	LP14	LP15	LP16	LP17	LP18	1	2	3	4	5	6	P1	P2
2-6450840-0	D																			Z5	Z5	Z5	Z5	Z5	Z5		
	C	LT	LT	LT	LT	LT	LT	LT	LT	LT	LT	LT	LT	LT	LT	LT	LT	LT	Y5	Y5	Y5	Y5	Y5	Y5	TT	TT	
	B																		R5	R5	R5	R5	R5	R5			
	A	HD																	O5	O5	O5	O5	O5	O5			
18LP + 24S + 2P		HD																									

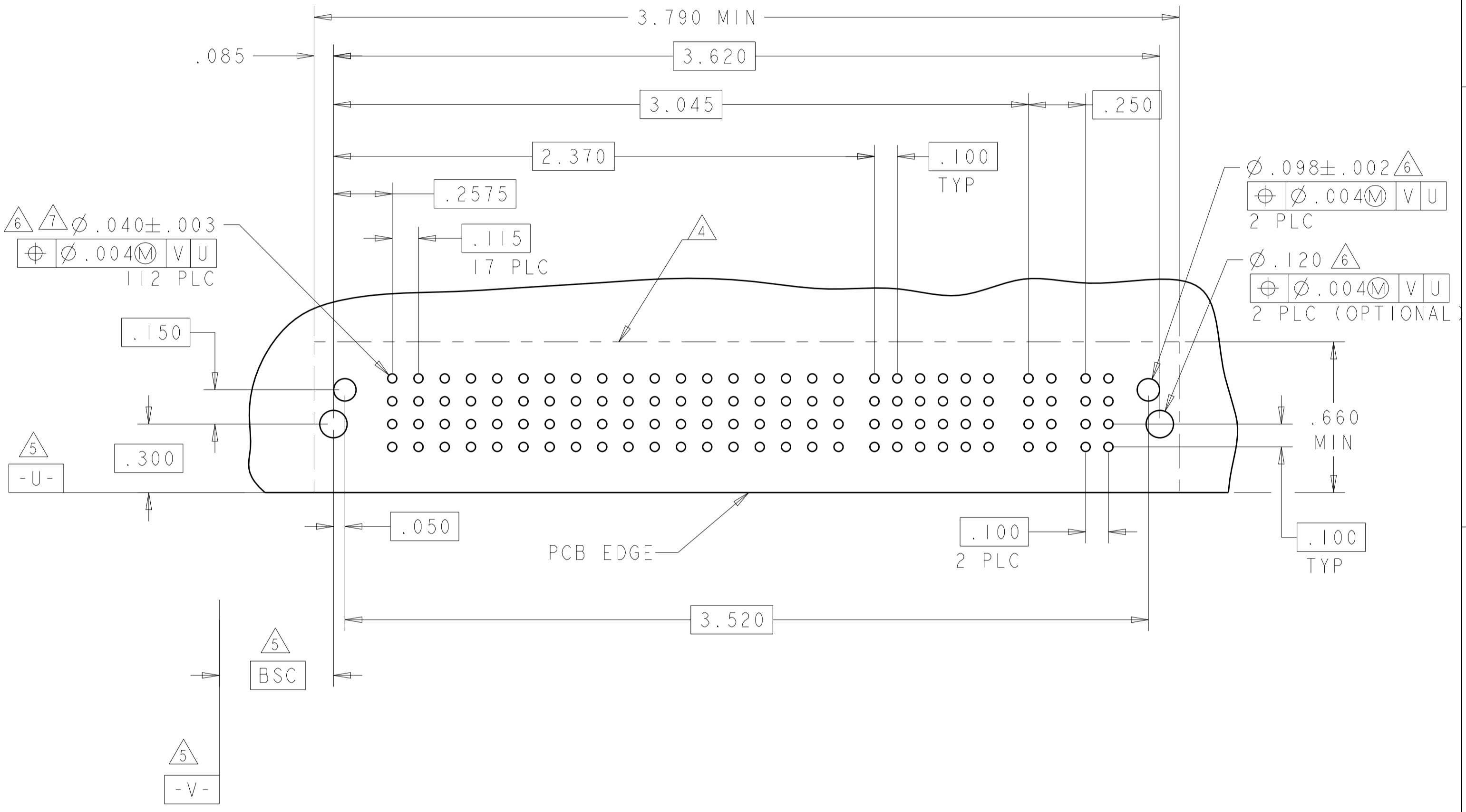
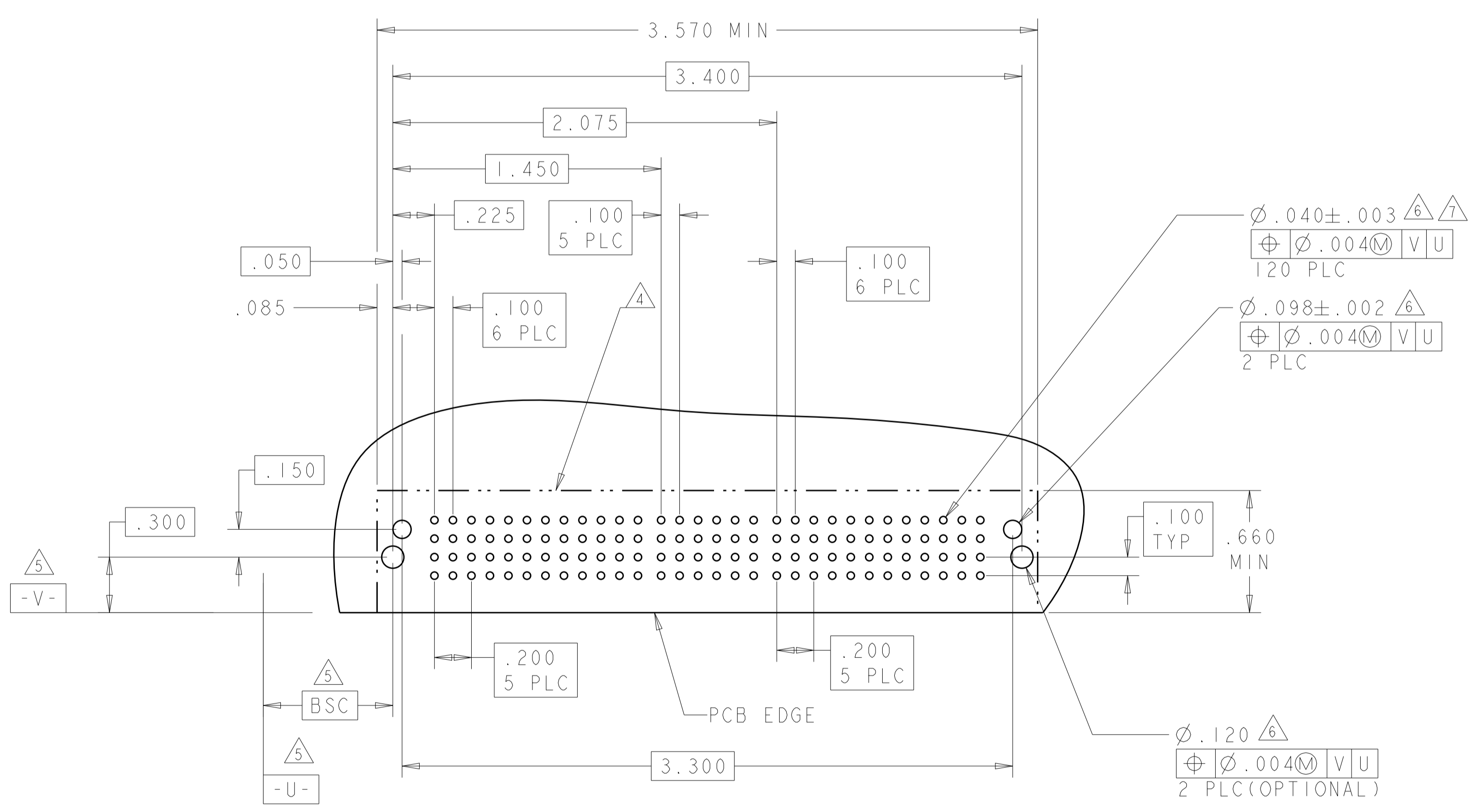

THIS DRAWING IS A CONTROLLED DOCUMENT. DWN: ALEX SHOAL 14DEC2007  
 CHK: Sunny Zhao 20DEC2007  
 APVD: Sunny Zhao 20DEC2007

**TE** Connectivity

NAME: RIGHT ANGLE HEADER W/ LP CONTACT AND SHORT END MODULES MULTI-BEAM XLE

PRODUCT SPEC: 108-2292  
 APPLICATION SPEC: 114-13251  
 WEIGHT: -

Customer Drawing

SCALE: 1:1 SHEET 9 OF 16 REV: H4



LOC	DIST	REVISIONS			
P	LTN	DESCRIPTION	DATE	OWN	APVD
ES	00	SEE SHEET 1			

PART NUMBER	ROWS	POWER		SIGNAL								LOW POWER				POWER														
		P1	P2	1	2	3	4	5	6	7	8	LP1	LP2	LP3	LP4	P3	P4	P5	P6	P7	P8	P9	P10	P11	P12	P13	P14	P15	P16	
2-6450840-1	D	TT	TT	Z5	Z5	Z5	Z5	Z5	Z5	Z5	Z5																			
	C			Y5	Y5	Y5	Y5	Y5	Y5	Y5	Y5																			
	B	R5	R5	R5	R5	R5	R5	R5	R5																					
	A	HD	O5	O5	O5	O5	O5	O5	O5																					

2P + 32S + 4LP + 14P

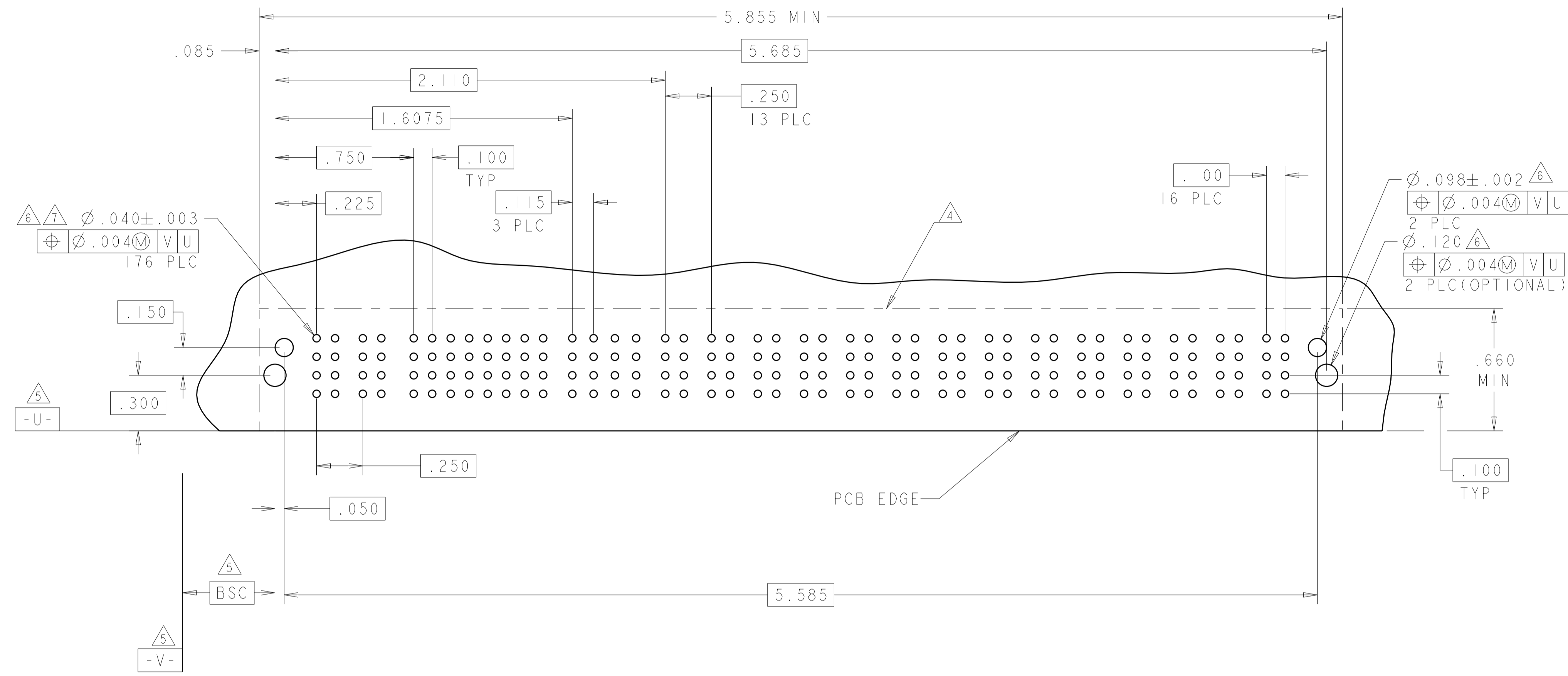

THIS DRAWING IS A CONTROLLED DOCUMENT.

DIMENSIONS: INCHES	TOLERANCES UNLESS OTHERWISE SPECIFIED: 0 PLC ±. 1 PLC ±.01 2 PLC ±.01 3 PLC ±.005 4 PLC ±.0050 ANGLES ±.2°	OWN: ALEX SHOAL 14DEC2007 CHK: Sunny Zhao 20DEC2007 APVD: Sunny Zhao 20DEC2007	NAME: RIGHT ANGLE HEADER W/ LP CONTACT AND SHORT END MODULES MULTI-BEAM XLE
MATERIAL: -	FINISH: -	PRODUCT SPEC: 108-2292 APPLICATION SPEC: 114-13251 WEIGHT: -	SIZE: A100779 CAGE CODE: C=6450840 RESTRICTED TO: -
Customer Drawing		SCALE: 1:1	SHEET 11 OF 16 REV H4

4805 (3/11)





LOC	DIST	REVISIONS			
ES	00	REV	DATE	BY	APPD
		-	SEE SHEET 1	-	-

PART NUMBER	ROWS	POWER						SIGNAL						POWER					
		P1	P2	P3	P4	P5	P6	1	2	3	4	5	6	P7	P8	P9	P10	P11	P12
2-6450840-7	D							Z5	Z5	Z5	Z5	Z5	Z5						
	C							Y5	Y5	Y5	Y5	Y5	Y5						
	B							R5	R5	R5	R5	R5	R5						
	A	HD						O1	O5	O5	O5	O5	O5						
6P + 24S + 6P																			

G7

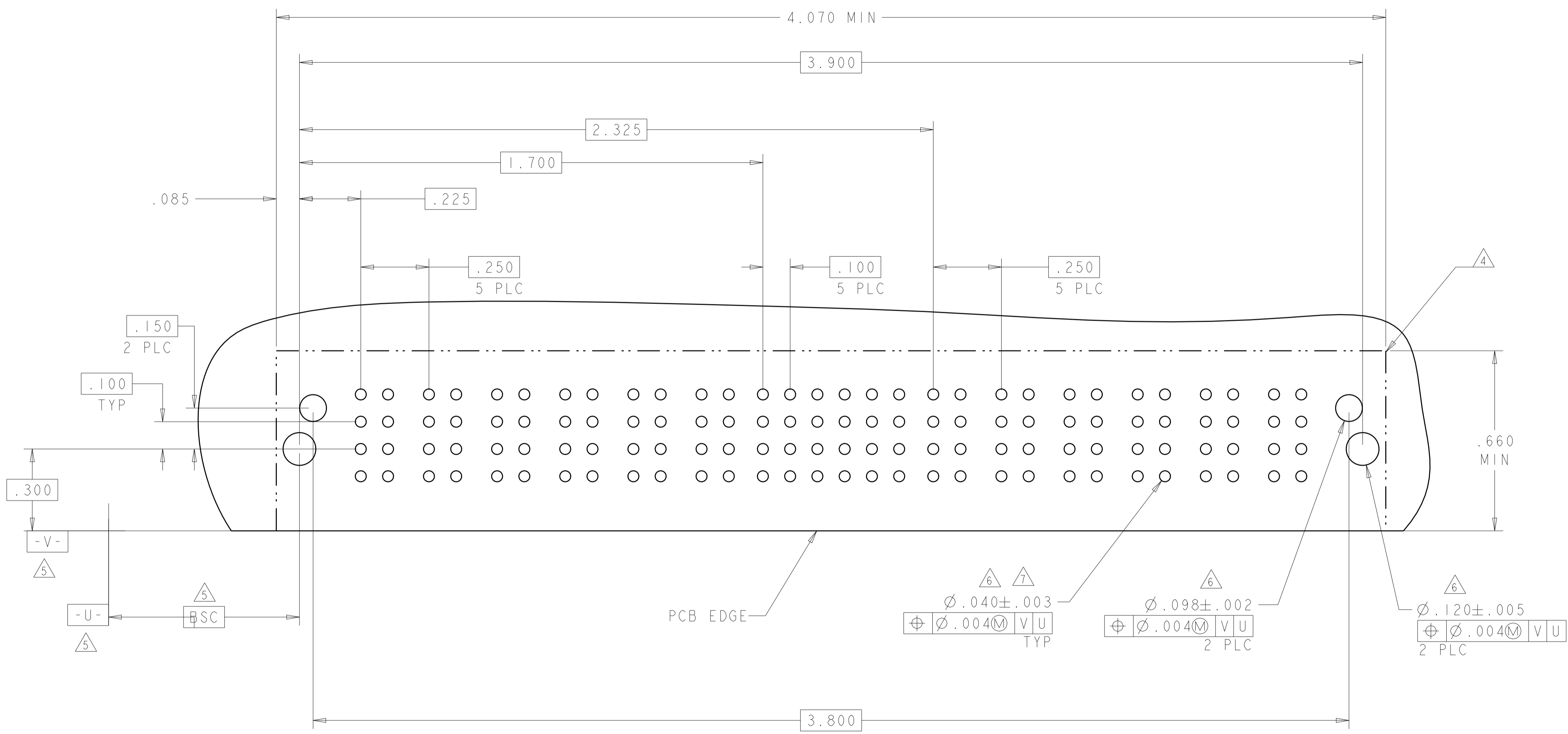

THIS DRAWING IS A CONTROLLED DOCUMENT.		OWN: ALEX SHOAL 14DEC2007	
DIMENSIONS: INCHES		CHK: Sunny Zhao 20DEC2007	
TOLERANCES UNLESS OTHERWISE SPECIFIED:		APVD: Sunny Zhao 20DEC2007	NAME: RIGHT ANGLE HEADER W/ LP CONTACT AND SHORT END MODULES MULTI-BEAM XLE
0 PLC ±	1 PLC ±.01	PRODUCT SPEC: 108-2292	SIZE: A100779
2 PLC ±.005	3 PLC ±.005	APPLICATION SPEC: 114-13251	CAGE CODE: C=6450840
4 PLC ±.0050	ANGLES ±.7°	WEIGHT: -	RESTRICTED TO: -
MATERIAL: -	FINISH: -	Customer Drawing	SCALE: 1:1 SHEET 14 OF 16 REV: H4



LOC	DIST	REVISIONS					
		P	LTN	DESCRIPTION	DATE	DMN	APVD
ES	00	-	-	SEE SHEET 1	-	-	-

PART NUMBER	ROWS	POWER						SIGNAL						POWER				
		LP1	LP2	LP3	LP4	LP5	LP6	1	2	3	4	5	6	P1	P2	P3		
3-6450840-3	D C B A	[HD]	LT	LT	LT	LT	LT	LT	Z5	Z5	Z5	Z5	Z5	Z5	TT	TT	TT	[HD]
			Y5	Y5	Y5	Y5	Y5	Y5	R5	R5	R5	R5	R5	R5				
			O5	O5	O5	O5	O5	O5										
6LP + 24S + 3P																		

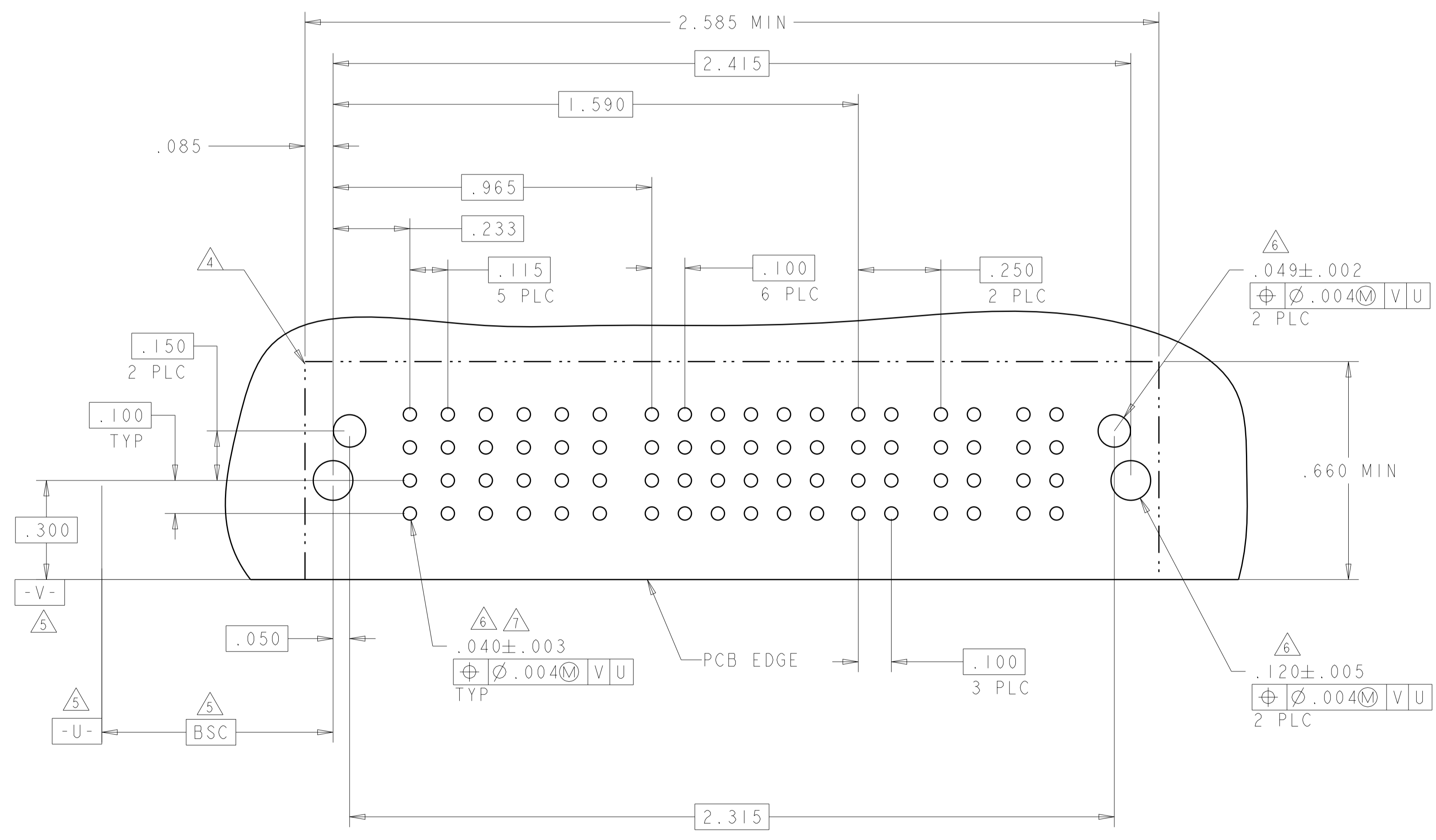

THIS DRAWING IS A CONTROLLED DOCUMENT.		DMN	ALEX SHOAL	14DEC2007	TE Connectivity
DIMENSIONS: INCHES		CHK	Sunny Zhao	20DEC2007	
TOLERANCES UNLESS OTHERWISE SPECIFIED:		APVD	Sunny Zhao	20DEC2007	NAME
0 PLC	±	PRODUCT SPEC			RIGHT ANGLE HEADER
1 PLC	±.01	APPLICATION SPEC			W/ LP CONTACT AND SHORT END MODULES
2 PLC	±.01	APPLIC. SPEC			MULTI-BEAM XLE
3 PLC	±.005	SIZE	CAGE CODE	DRAWING NO	RESTRICTED TO
4 PLC	±.0050	114-13251		A100779	C=6450840
ANGLES	±.2°	WEIGHT			
FINISH		Customer Drawing			SCALE 1:1 SHEET 16 OF 16 REV H4





Компания «ЭлектроПласт» предлагает заключение долгосрочных отношений при поставках импортных электронных компонентов на взаимовыгодных условиях!

Наши преимущества:

- Оперативные поставки широкого спектра электронных компонентов отечественного и импортного производства напрямую от производителей и с крупнейших мировых складов;
- Поставка более 17-ти миллионов наименований электронных компонентов;
- Поставка сложных, дефицитных, либо снятых с производства позиций;
- Оперативные сроки поставки под заказ (от 5 рабочих дней);
- Экспресс доставка в любую точку России;
- Техническая поддержка проекта, помощь в подборе аналогов, поставка прототипов;
- Система менеджмента качества сертифицирована по Международному стандарту ISO 9001;
- Лицензия ФСБ на осуществление работ с использованием сведений, составляющих государственную тайну;
- Поставка специализированных компонентов (Xilinx, Altera, Analog Devices, Intersil, Interpoint, Microsemi, Aeroflex, Peregrine, Syfer, Eurofarad, Texas Instrument, Miteq, Cobham, E2V, MA-COM, Hittite, Mini-Circuits, General Dynamics и др.);

Помимо этого, одним из направлений компании «ЭлектроПласт» является направление «Источники питания». Мы предлагаем Вам помощь Конструкторского отдела:

- Подбор оптимального решения, техническое обоснование при выборе компонента;
- Подбор аналогов;
- Консультации по применению компонента;
- Поставка образцов и прототипов;
- Техническая поддержка проекта;
- Защита от снятия компонента с производства.



#### Как с нами связаться

**Телефон:** 8 (812) 309 58 32 (многоканальный)

**Факс:** 8 (812) 320-02-42

**Электронная почта:** [org@eplast1.ru](mailto:org@eplast1.ru)

**Адрес:** 198099, г. Санкт-Петербург, ул. Калинина, дом 2, корпус 4, литера А.