

# MultiGuard (2 & 4 Elements)

## AVX Multilayer Ceramic Transient Voltage Suppression Arrays – ESD Protection for CMOS and Bi Polar Systems



### GENERAL DESCRIPTION AND COMMENTS

AVX's Transient Voltage Suppression (TVS) Arrays address six trends in today's electronic circuits: (1) mandatory ESD protection, (2) mandatory EMI control, (3) signal integrity improvement, (4) PCB downsizing, (5) reduced component placement costs, and (6) protection from induced slow speed transient voltages and currents.

AVX's MultiGuard products offer numerous advantages, which include a faster turn-on-time (<1nS), repetitive strike capability, and space savings. In some cases, MultiGuard consumes less than 75% of the PCB real estate required for the equivalent number of discrete chips. This size advantage, coupled with the savings associated with placing only one chip, makes MultiGuard the TVS component of choice for

ESD protection of I/O lines in portable equipment and programming ports in cellular phones. Other applications include differential data line protection, ASIC protection and LCD driver protection for portable computing devices.

Where multiple lines require the ESD protection, the 4-element 0612 chip is an ideal solution. The 2-element 0405 MultiGuard is the smallest TVS array device available in the market today.

Available with standard working voltage of 5.6V up to 18V with low capacitance in the 3 case sizes, AVX MultiGuard arrays offer a very broad range of integrated TVS solutions to the design community.



### ELECTRICAL CHARACTERISTICS PER ELEMENT

|                            | AVX Part Number | Working Voltage (DC) | Working Voltage (AC) | Breakdown Voltage | Clamping Voltage | Test Current For $V_c$ | Maximum Leakage Current | Transient Energy Rating | Peak Current Rating | Typical Cap |
|----------------------------|-----------------|----------------------|----------------------|-------------------|------------------|------------------------|-------------------------|-------------------------|---------------------|-------------|
| <b>2 Element 0405 Chip</b> | MG042S05X150 __ | 5.6                  | 4.0                  | 8.5±20%           | 18               | 1                      | 35                      | 0.05                    | 15                  | 300         |
|                            | MG042L14V400 __ | 14.0                 | 10.0                 | 18.5±12%          | 32               | 1                      | 15                      | 0.02                    | 15                  | 45          |
|                            | MG042L18V500 __ | 18.0                 | 14.0                 | N/A               | 50               | 1                      | 10                      | 0.02                    | 15                  | 40          |
| <b>2 Element 0508 Chip</b> | MG052S05A150 __ | 5.6                  | 4.0                  | 8.5±20%           | 18               | 1                      | 35                      | 0.10                    | 30                  | 825         |
|                            | MG052S09A200 __ | 9.0                  | 6.4                  | 12.7±15%          | 22               | 1                      | 25                      | 0.10                    | 30                  | 550         |
|                            | MG052S14A300 __ | 14.0                 | 10.0                 | 19.5±12%          | 32               | 1                      | 15                      | 0.10                    | 30                  | 425         |
|                            | MG052S18A400 __ | 18.0                 | 14.0                 | 25.5±10%          | 42               | 1                      | 10                      | 0.10                    | 30                  | 225         |
|                            | MG052L18X500 __ | ≤18.0                | ≤14.0                | N/A               | 50               | 1                      | 10                      | 0.10                    | 20                  | 50          |
| <b>4 Element 0612 Chip</b> | MG064S05A150 __ | 5.6                  | 4.0                  | 8.5±20%           | 18               | 1                      | 35                      | 0.10                    | 30                  | 825         |
|                            | MG064S09A200 __ | 9.0                  | 6.4                  | 12.7±15%          | 22               | 1                      | 25                      | 0.10                    | 30                  | 550         |
|                            | MG064S14A300 __ | 14.0                 | 10.0                 | 19.5±12%          | 32               | 1                      | 15                      | 0.10                    | 30                  | 425         |
|                            | MG064S18A400 __ | 18.0                 | 14.0                 | 25.5±10%          | 42               | 1                      | 10                      | 0.05                    | 15                  | 120         |
|                            | MG064L18X500 __ | ≤18.0                | ≤14.0                | N/A               | 50               | 1                      | 10                      | 0.10                    | 20                  | 75          |

Termination Finish Code  
Packaging Code

$V_w$ (DC) DC Working Voltage (V)  
 $V_w$ (AC) AC Working Voltage (V)  
 $V_B$  Typical Breakdown Voltage (V @ 1mA<sub>DC</sub>)  
 $V_B$  Tol  $V_B$  Tolerance is ± from Typical Value

$V_c$  Clamping Voltage (V @  $I_{c1}$ )  
 $I_{c1}$  Test Current for  $V_c$  (A, 8x20μS)  
 $I_l$  Maximum Leakage Current at the Working Voltage (μA)  
 $E_T$  Transient Energy Rating (J, 10x1000μS)  
 $I_p$  Peak Current Rating (A, 8x20μS)  
 Cap Typical Capacitance (pF) @ 1MHz and 0.5 V<sub>RMS</sub>

# MultiGuard (2&4 Elements)



AVX Multilayer Ceramic

Transient Voltage Suppression Arrays

ESD Protection for CMOS and Bi Polar Systems

## PHYSICAL DIMENSIONS AND PAD LAYOUT

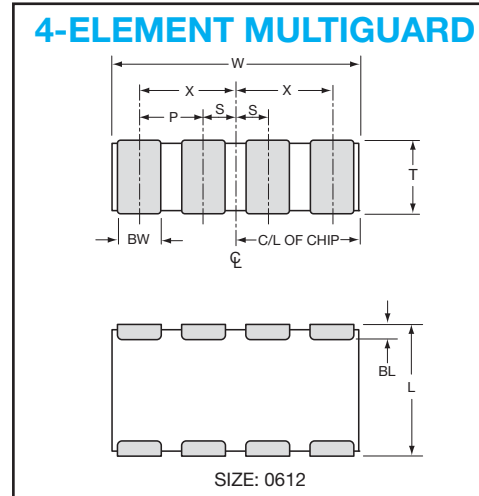
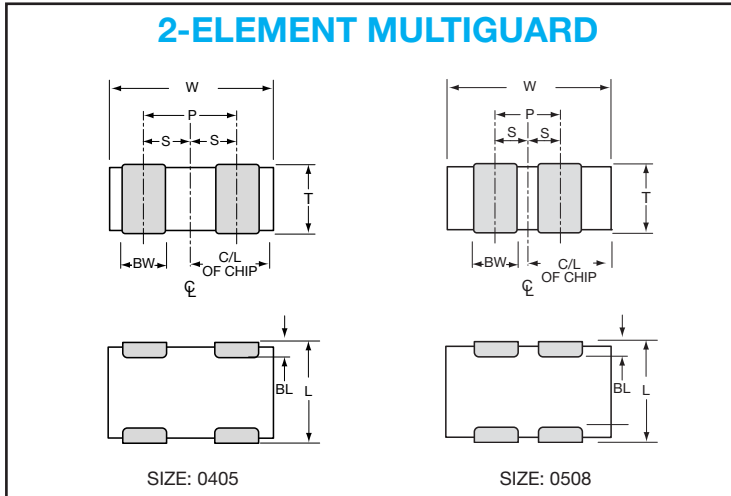

### 0405 2 Element Dimensions mm (inches)

| L                          | W                          | T                       | BW                         | BL                         | P                      | S                          |
|----------------------------|----------------------------|-------------------------|----------------------------|----------------------------|------------------------|----------------------------|
| 1.00±0.15<br>(0.039±0.006) | 1.37±0.15<br>(0.054±0.006) | 0.66 MAX<br>(0.026 MAX) | 0.36±0.10<br>(0.014±0.004) | 0.20±0.10<br>(0.008±0.004) | 064 REF<br>(0.025 REF) | 0.32±0.10<br>(0.013±0.004) |

### 0612 4 Element Dimensions mm (inches)

| L                          | W                          | T                       | BW                         | BL  | P                       | X                          | S                          |
|----------------------------|----------------------------|-------------------------|----------------------------|---|-------------------------|----------------------------|----------------------------|
| 1.60±0.20<br>(0.063±0.008) | 3.20±0.20<br>(0.126±0.008) | 1.22 MAX<br>(0.048 MAX) | 0.41±0.10<br>(0.016±0.004) | 0.18 <sup>+0.25</sup> <sub>-0.08</sub><br>(0.007 <sup>+0.08</sup> <sub>-0.003</sub> ) | 0.76 REF<br>(0.030 REF) | 1.14±0.10<br>(0.045±0.004) | 0.38±0.10<br>(0.015±0.004) |

### 0508 2 Element Dimensions mm (inches)

| L                          | W                          | T                       | BW                        | BL   | P                       | S                          |
|----------------------------|----------------------------|-------------------------|---------------------------|--|-------------------------|----------------------------|
| 1.25±0.20<br>(0.049±0.008) | 2.01±0.20<br>(0.079±0.008) | 1.02 MAX<br>(0.040 MAX) | 0.41±0.1<br>(0.016±0.004) | 0.18 <sup>+0.25</sup> <sub>-0.08</sub><br>(0.007 <sup>+0.010</sup> <sub>-0.003</sub> ) | 0.76 REF<br>(0.030 REF) | 0.38±0.10<br>(0.015±0.004) |

### Pad Layout Dimensions

| A                     | B               | C               | D               | E               |
|-----------------------|-----------------|-----------------|-----------------|-----------------|
| <b>0405 2 Element</b> |                 |                 |                 |                 |
| 0.46<br>(0.018)       | 0.74<br>(0.029) | 1.20<br>(0.047) | 0.38<br>(0.015) | 0.64<br>(0.025) |

| A                     | B               | C               | D               | E               |
|-----------------------|-----------------|-----------------|-----------------|-----------------|
| <b>0508 2 Element</b> |                 |                 |                 |                 |
| 0.89<br>(0.035)       | 1.27<br>(0.050) | 2.16<br>(0.085) | 0.46<br>(0.018) | 0.76<br>(0.030) |

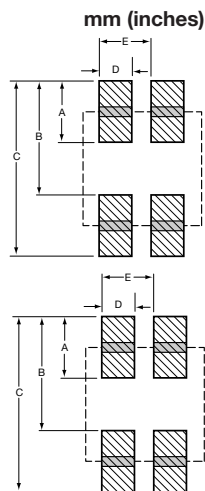

### Pad Layout Dimensions

| A                     | B               | C               | D               | E               |
|-----------------------|-----------------|-----------------|-----------------|-----------------|
| <b>0612 4 Element</b> |                 |                 |                 |                 |
| 0.89<br>(0.035)       | 1.65<br>(0.065) | 2.54<br>(0.100) | 0.46<br>(0.018) | 0.76<br>(0.030) |

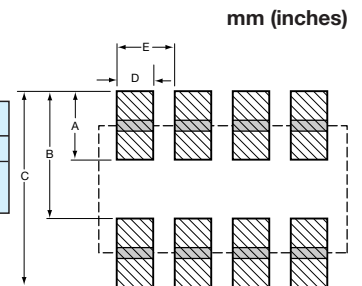

### HOW TO ORDER

|                   |                                     |                                  |  |  |   |   |                                      |                           |
|-------------------|-------------------------------------|----------------------------------|--|--|---|---|--------------------------------------|---------------------------|
| <b>MG</b>         | <b>04</b>                           | <b>2</b>                         | <b>L</b>   | <b>14</b>  | <b>A</b>  | <b>300</b>  | <b>T</b>                             | <b>P</b>                  |
| <b>MultiGuard</b> | <b>Case Size</b>                    | <b>Configuration</b>             | <b>Style</b>                                     | <b>Working Voltage</b>                                     | <b>Energy Rating</b>                                  | <b>Clamping Voltage</b>                                       | <b>Packaging (PCS/REEL)</b>          | <b>Termination Finish</b> |
|                   | 04 = 0405<br>05 = 0508<br>06 = 0612 | 2 = 2 Elements<br>4 = 4 Elements | S = Standard Construction<br>L = Low Capacitance | 05 = 5.6VDC<br>09 = 9.0VDC<br>14 = 14.0VDC<br>18 = 18.0VDC | A = 0.10 Joules<br>V = 0.02 Joules<br>X = 0.05 Joules | 150 = 18V<br>200 = 22V<br>300 = 32V<br>400 = 42V<br>500 = 50V | D = 1,000<br>R = 4,000<br>T = 10,000 | P = Ni/Sn Alloy (Plated)  |



# MultiGuard (2 & 4 Elements)

## AVX Multilayer Ceramic

### Transient Voltage Suppression Arrays

### ESD Protection for CMOS and Bi Polar Systems



#### TYPICAL PERFORMANCE CURVES – VOLTAGE/CURRENT CHARACTERISTICS

Multilayer construction and improved grain structure result in excellent transient clamping characteristics in excess of 30 amps (20 amps on MG064L18X500) peak current while maintaining very low leakage currents under DC operating

conditions. The VI curves below show the voltage/current characteristics for the 5.6V, 9V, 14V and 18V parts with currents ranging from fractions of a micro amp to tens of amps.

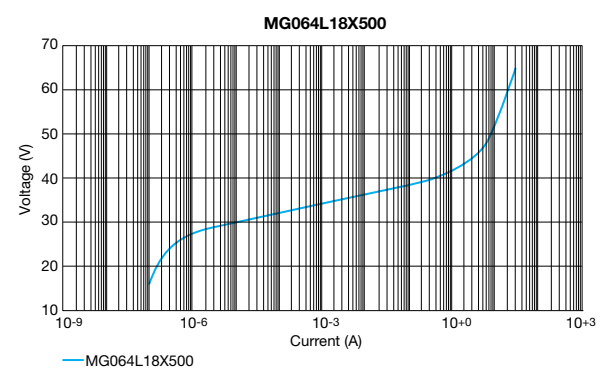
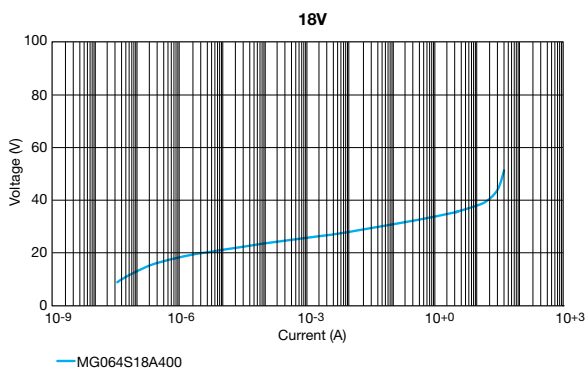
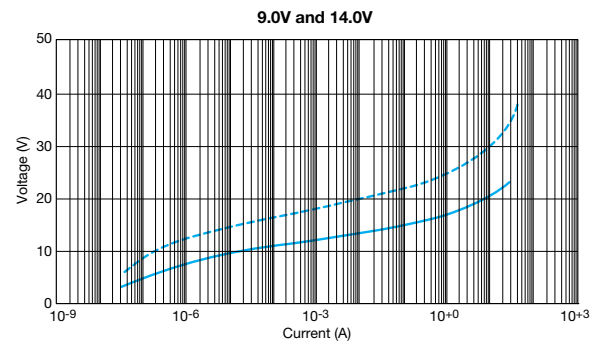
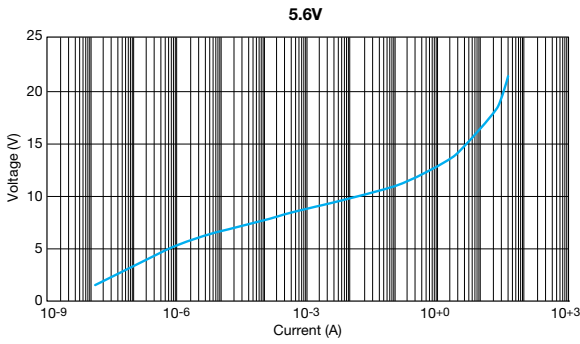

#### TYPICAL PERFORMANCE CURVES – TEMPERATURE CHARACTERISTICS

MultiGuard suppressors are designed to operate over the full temperature range from -55°C to +125°C.

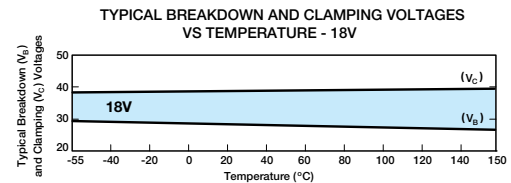
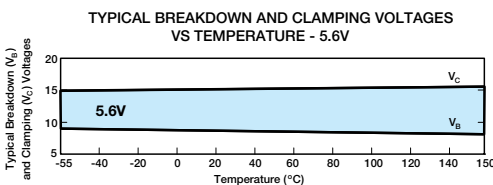
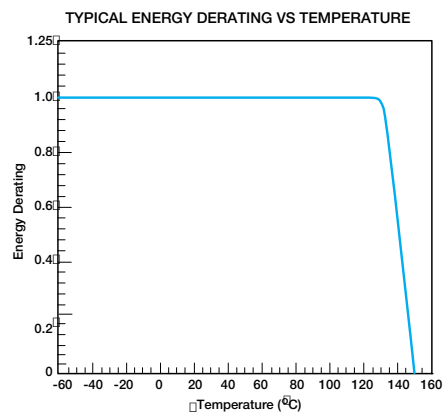
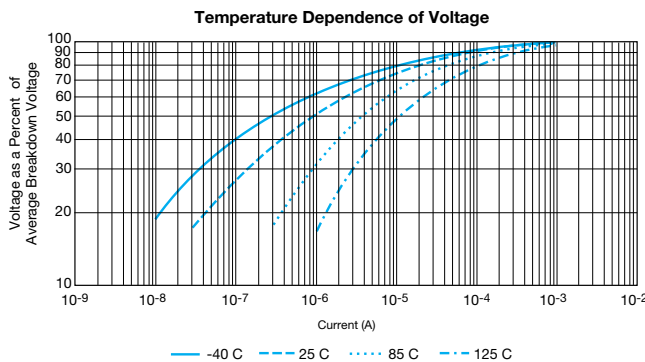

# MultiGuard (2 & 4 Elements)

## AVX Multilayer Ceramic

### Transient Voltage Suppressors Arrays

### ESD Protection for CMOS and Bi Polar Systems



## TRANSIENT VOLTAGE SUPPRESSORS – TYPICAL PERFORMANCE CURVES

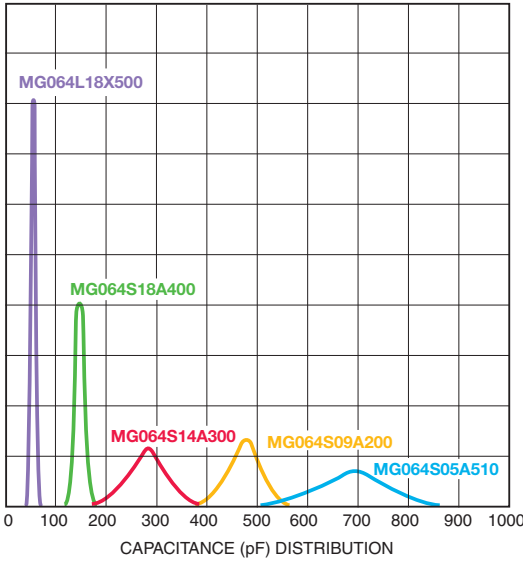
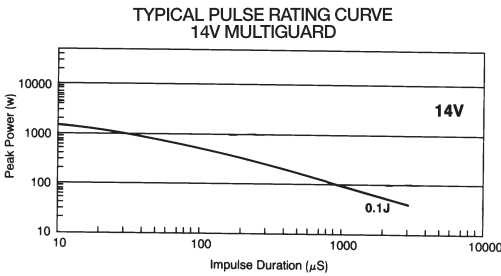
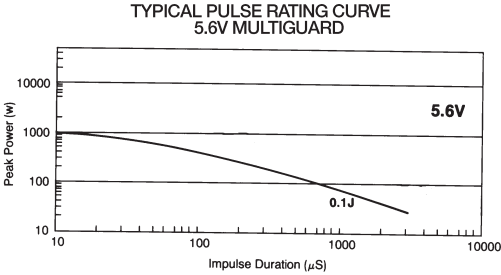

## APPLICATION

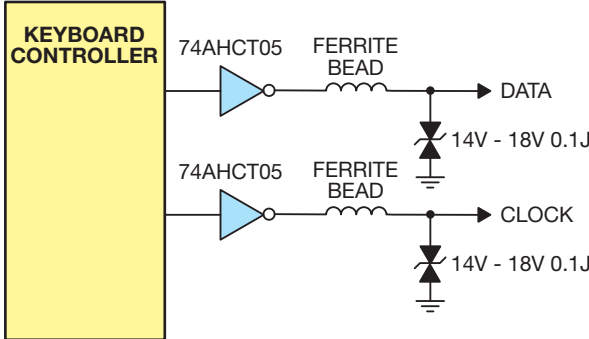
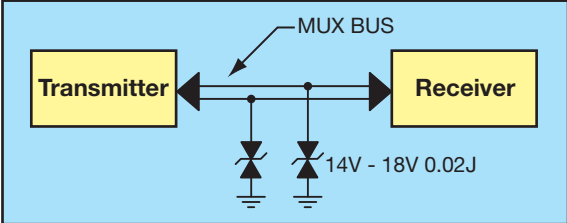



Компания «ЭлектроПласт» предлагает заключение долгосрочных отношений при поставках импортных электронных компонентов на взаимовыгодных условиях!

Наши преимущества:

- Оперативные поставки широкого спектра электронных компонентов отечественного и импортного производства напрямую от производителей и с крупнейших мировых складов;
- Поставка более 17-ти миллионов наименований электронных компонентов;
- Поставка сложных, дефицитных, либо снятых с производства позиций;
- Оперативные сроки поставки под заказ (от 5 рабочих дней);
- Экспресс доставка в любую точку России;
- Техническая поддержка проекта, помощь в подборе аналогов, поставка прототипов;
- Система менеджмента качества сертифицирована по Международному стандарту ISO 9001;
- Лицензия ФСБ на осуществление работ с использованием сведений, составляющих государственную тайну;
- Поставка специализированных компонентов (Xilinx, Altera, Analog Devices, Intersil, Interpoint, Microsemi, Aeroflex, Peregrine, Syfer, Eurofarad, Texas Instrument, Miteq, Cobham, E2V, MA-COM, Hittite, Mini-Circuits, General Dynamics и др.);

Помимо этого, одним из направлений компании «ЭлектроПласт» является направление «Источники питания». Мы предлагаем Вам помощь Конструкторского отдела:

- Подбор оптимального решения, техническое обоснование при выборе компонента;
- Подбор аналогов;
- Консультации по применению компонента;
- Поставка образцов и прототипов;
- Техническая поддержка проекта;
- Защита от снятия компонента с производства.



#### Как с нами связаться

**Телефон:** 8 (812) 309 58 32 (многоканальный)

**Факс:** 8 (812) 320-02-42

**Электронная почта:** [org@eplast1.ru](mailto:org@eplast1.ru)

**Адрес:** 198099, г. Санкт-Петербург, ул. Калинина, дом 2, корпус 4, литера А.