

**Shrouded Power Relay F4**

- Pin assignment similar to ISO 7588 part 1
- Plug-in terminals
- Customized versions on request
  - Integrated components (e.g. resistor, diode)
  - Customized marking

Typical applications

Cross carline up to 40A for example: ABS control, blower fans, car alarm, cooling fan, Electric Power Steering, energy management, engine control, fuel pump, heated front screen, lamps: front, rear, fog light, main switch/supply relay, valves, wiper control.

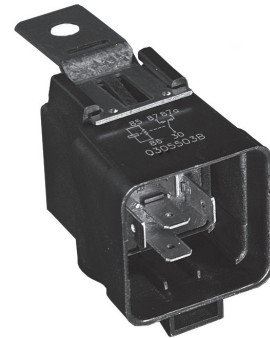

F134-F4\_Shrouded\_tbw1

**Contact Data**

Contact arrangement	1 form C, 1 CO	
Rated voltage	12VDC	24VDC
Limiting continuous current,		
23°C	NO/NC	
85°C	60/45A	
125°C	40/30A	
Limiting making current <sup>1)</sup>	17/12A	
Limiting breaking current	60/40A	20/15A
Limiting short-time current	120/45A	
overload current, ISO 8820-3 <sup>2)</sup>	1.35 x 40A, 1800s	
	2.00 x 40A, 60s	
	6.00 x 40A, 1s	
Jump start test, ISO 16750-1	24VDC for 5min,	
conducting nominal current at 23°C		
Contact material	silver based	
Min. recommended contact load <sup>3)</sup>	1A at 5VDC	
Initial voltage drop at 10A,		
NO contact, typ./max.	15mV/200mV	
NC contact, typ./max.	20mV/250mV	
Frequency of operation at nominal load	6 ops./min (0.1Hz)	
Operate/release time typ.	7/2ms <sup>4)</sup>	
Electrical endurance <sup>5)</sup>	>1x10 <sup>5</sup> ops.	
resistive load, NO contact	40A, 14VDC	20A, 28VDC

**Contact Data (continued)**

Mechanical endurance	>1x10 <sup>6</sup> ops.
1) The values apply to a resistive or inductive load with suitable spark suppression and at maximum 14VDC for 12VDC or 28VDC for 24VDC load voltages. For a load current duration of maximum 3s for a make/break ratio of 1:10.	
2) Current and time are compatible with circuit protection by a typical automotive fuse. Relay will make, carry and break the specified current.	
3) See chapter Diagnostics of Relays in our Application Notes or consult the internet at <a href="http://relays.te.com/appnotes/">http://relays.te.com/appnotes/</a>	
4) For unsuppressed relay coil. Any parallel device to the coil will increase the release time.	
5) Any diode or pn-junction parallel to the coil (internal or external) will significantly decrease the electrical lifetime, especially when used for inductive loads.	

**Coil Data**

Rated coil voltage	12/24VDC				
Coil versions, DC coil					
Coil code	Rated voltage VDC	Operate voltage VDC	Release voltage VDC	Coil resistance <sup>6)</sup> Ω±10%	Rated coil power <sup>6)</sup> W
052	12	7.2	1.6	90	1.6
064	24	14.4	2.4	360	1.6

6) Without components in parallel.  
All figures are given for coil without pre-energization, at ambient temperature +23°C.

**Max. DC load breaking capacity**

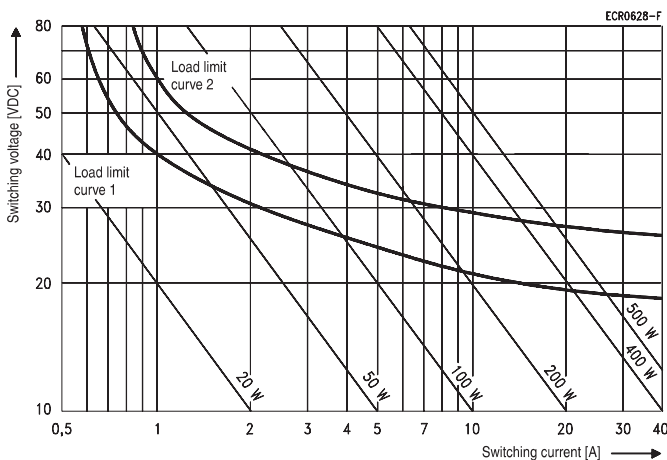

Load limit curve 1: arc extinguishes during transit time (changeover contact).  
Load limit curve 2: safe shutdown, no stationary arc (make contact).  
Load limit curves measured with low inductive resistors verified for 1000 switching events.

**Coil operating range**

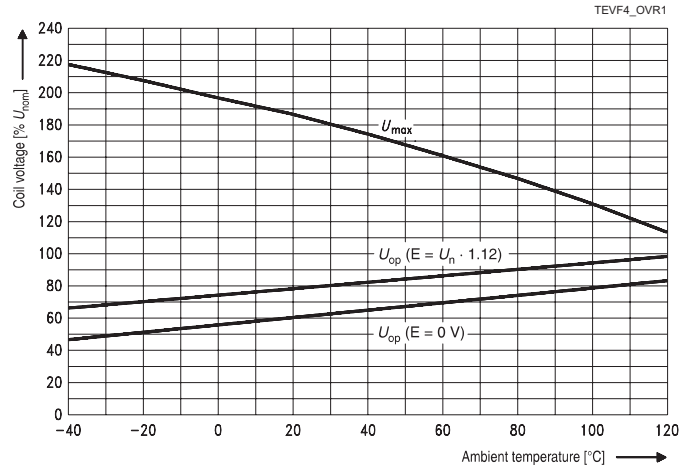

Does not take into account the temperature rise due to the contact current  
E = pre-energization.

**Shrouded Power Relay F4 (Continued)**

**Insulation Data**

Initial dielectric strength	
between open contacts	500V <sub>rms</sub>
between contact and coil	500V <sub>rms</sub>
between adjacent contacts	500V <sub>rms</sub>

**Other Data**

EU RoHS/ELV compliance	compliant
Protection to heat and fire according UL94	UL94-HB or better
Ambient temperature	-40 to 125°C
Category of environmental protection, IEC 61810	RT I (dustproof), RT III (weatherproof – shrouded)
Degree of protection, IEC 60529	IP54 (dustproof), IP67 (weatherproof), only with special connector
Vibration resistance (functional) IEC 60068-2-6 (sine sweep)	10 to 500Hz, min. 5g <sup>7)</sup>
Shock resistance (functional) IEC 60068-2-27 (half sine)	11ms, min. 20g <sup>7)</sup>
Drop test, free fall, IEC 60068-2-32	1m onto concrete

**Other Data (continued)**

Terminal type	plug-in, QC
Cover retention	
axial force	150N
pull force	150N
push force	200N
Terminal retention	
pull force	100N
push force	100N
resistance to bending	10N <sup>8)</sup>
force applied to side	10N <sup>8)</sup>
torque	0.3Nm
Weight	approx. 60g (2.1oz)
Packaging unit	110 pcs.
7) No change in the switching state >10µs. Valid for NC contacts, NO contact values significantly higher.	
8) Values apply 2mm from the end of the terminal. When the force is removed, the terminal must not have moved by more than 0.3mm.	

**Accessories**

For details see datasheet	Connectors for Mini, Mini (Shrouded) and Maxi ISO Relays
---------------------------	---

**Terminal Assignment**

CO  
1 form C, 1 CO

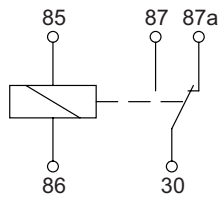

COD  
1 form C, 1 CO with diode

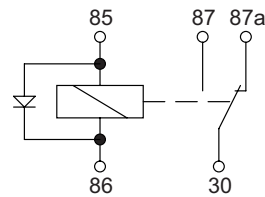

COR  
1 form C, 1 CO with resistor

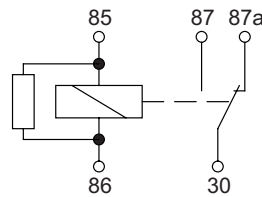

**Dimensions**

Product codes V23134-A4052-X543 and V23134-A4064-X550

View of the terminals (bottom view)

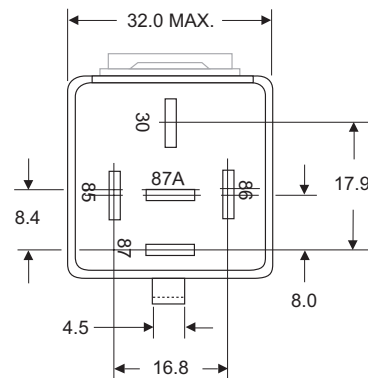
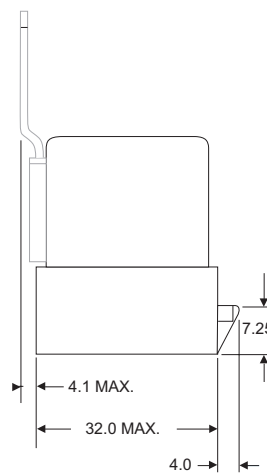
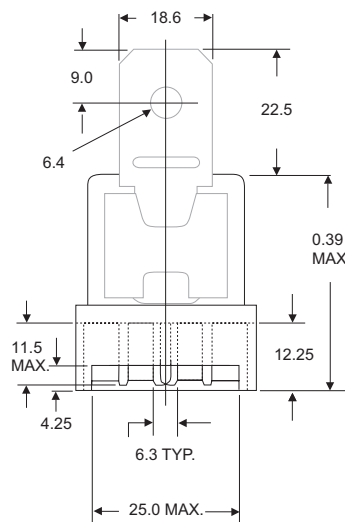

TE1347-82

**Shrouded Power Relay F4** (Continued)

**Dimensions**

Product codes V23134-A4052-X544, V23134-A4052-X549 and V23134-A4064-X551

View of the terminals (bottom view)

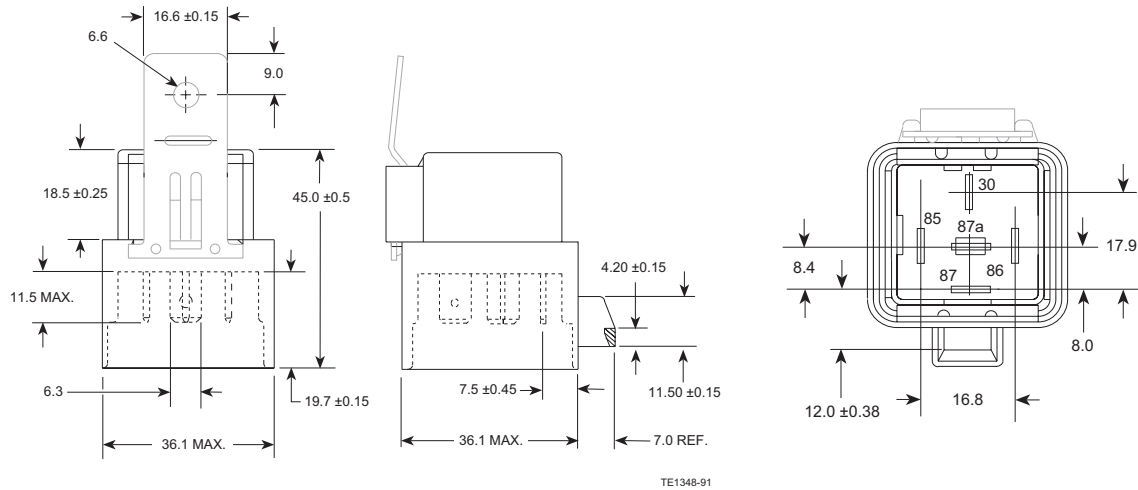

<b>Product code structure</b>	Typical product code	<b>V23134</b>	<b>-A</b>	<b>4</b>	<b>052</b>	<b>-X544</b>
<b>Type</b>	Power Relay F4					
<b>Contact arrangement</b>	A 1 form C, 1 CO					
<b>Cover</b>	4 Shrouded with bracket					
<b>Coil</b>	<b>052</b> 12VDC	<b>064</b> 24VDC				
<b>Terminal / arrangement</b>	Xnnn Customized (nnn: version number)					

Product code	Equivalent to	Arrangement	Cover	Coil suppression	Circuit <sup>1)</sup>	Coil	Contact material	Terminals	Part number
V23134-A4052-X543	VF4A-55F11-S01 (8-1393305-7)	1 form C, 1 CO	Dustproof	Resistor 680Ω	COR	12VDC	Silver based	Plug-in, QC	2-1904131-9
V23134-A4052-X544	VF4A-65F11-S01 (9-1393305-5)		Weather-proof						3-1904131-5
V23134-A4052-X549	VF4A-65F11-S05 (9-1393305-6)			Diode (cathode 86)	COD				3-1904131-3
V23134-A4064-X551	VF4A-65H11-S08 (9-1393305-9)			Resistor 2700Ω	COR	24VDC			3-1904131-7
V23134-A4064-X550	VF4A-55H11-S05 (8-1393305-9)		Dustproof	Diode (cathode 86)	COD				3-1904131-6

1) See terminal assignment diagrams.

Other types on request. This list represents the most common types and does not show all variants covered by this datasheet.



Компания «ЭлектроПласт» предлагает заключение долгосрочных отношений при поставках импортных электронных компонентов на взаимовыгодных условиях!

Наши преимущества:

- Оперативные поставки широкого спектра электронных компонентов отечественного и импортного производства напрямую от производителей и с крупнейших мировых складов;
- Поставка более 17-ти миллионов наименований электронных компонентов;
- Поставка сложных, дефицитных, либо снятых с производства позиций;
- Оперативные сроки поставки под заказ (от 5 рабочих дней);
- Экспресс доставка в любую точку России;
- Техническая поддержка проекта, помощь в подборе аналогов, поставка прототипов;
- Система менеджмента качества сертифицирована по Международному стандарту ISO 9001;
- Лицензия ФСБ на осуществление работ с использованием сведений, составляющих государственную тайну;
- Поставка специализированных компонентов (Xilinx, Altera, Analog Devices, Intersil, Interpoint, Microsemi, Aeroflex, Peregrine, Syfer, Eurofarad, Texas Instrument, Miteq, Cobham, E2V, MA-COM, Hittite, Mini-Circuits, General Dynamics и др.);

Помимо этого, одним из направлений компании «ЭлектроПласт» является направление «Источники питания». Мы предлагаем Вам помощь Конструкторского отдела:

- Подбор оптимального решения, техническое обоснование при выборе компонента;
- Подбор аналогов;
- Консультации по применению компонента;
- Поставка образцов и прототипов;
- Техническая поддержка проекта;
- Защита от снятия компонента с производства.



#### Как с нами связаться

**Телефон:** 8 (812) 309 58 32 (многоканальный)

**Факс:** 8 (812) 320-02-42

**Электронная почта:** [org@eplast1.ru](mailto:org@eplast1.ru)

**Адрес:** 198099, г. Санкт-Петербург, ул. Калинина, дом 2, корпус 4, литера А.