

user's guide to

# GAMING shield

Gaming shield is an extension board for your mikromedia that provides you with standard gaming buttons and audio speakers, so you can build and play your favorite arcade games.



# TO OUR VALUED CUSTOMERS

I want to express my thanks to you for being interested in our products and for having confidence in Mikroelektronika.

The primary aim of our company is to design and produce high quality electronic products and to constantly improve the performance thereof in order to better suit your needs.

A handwritten signature in white ink, appearing to read 'NM', is positioned above the name and title of the General Manager.

Nebojsa Matic  
General Manager

# Table of Contents

---

Introduction to mikromedia GAMING shield	4
Mikromedia compatibility	5
Key Features	6
System Specification	7
1. Soldering stacking headers	8
2. Connecting to mikromedias	10
3. Connecting to other shields	11
4. Control Buttons and signal LEDs	12
5. Audio module	14
6. Gaming pinout on supported mikromedia boards	16
Gaming pinout on mikromedia for PIC18FJ	16
Gaming pinout on mikromedia for dsPIC33	17
Gaming pinout on mikromedia for XMEGA	18
7. Dimensions	19

---

# Introduction to mikromedia GAMING shield

**mikromedia GAMING shield** is an extension board pin-compatible with several mikromedia boards from mikroElektronika that enables users to provide **button controls** and **audio interface** to your base mikromedia board, which is specially suitable for creating your own gaming console. GAMING Shield comes with convenient **stacking connectors**, so you can easily connect not only mikromedia, but other shields as well, such as **Battery boost shield**. It's carefully designed to fit perfectly into anyone's hands, and it has convenient holders which provide great stability when board is connected to mikromedia.

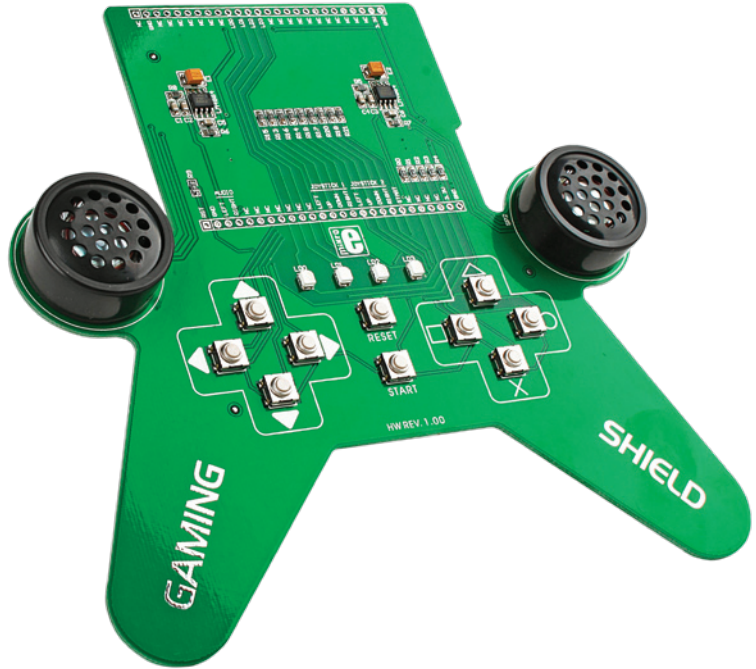

# Mikromedia compatibility



mikromedia for XMEGA



mikromedia for dsPIC33



mikromedia for PIC18FJ

Board is compatible with **mikromedia for PIC18FJ v105**, **mikromedia for dsPIC33 v105 & v106** and **mikromedia for XMEGA v110**. All of the mentioned boards can exploit the full potential of the Gaming Shield, including buttons, signal LEDs and audio speakers.

# Key Features

- 01 Top connections pads
- 02 Left Audio Channel amplifier circuit
- 03 Right Audio Channel amplifier circuit
- 04 Bottom connections pads
- 05 Left Speaker
- 06 Right Speaker
- 07 Navigation Joystick
- 08 Action Joystick
- 09 Reset Button
- 10 Start Button
- 11 Indicator LEDs
- 12 Left hand grip
- 13 Right hand grip

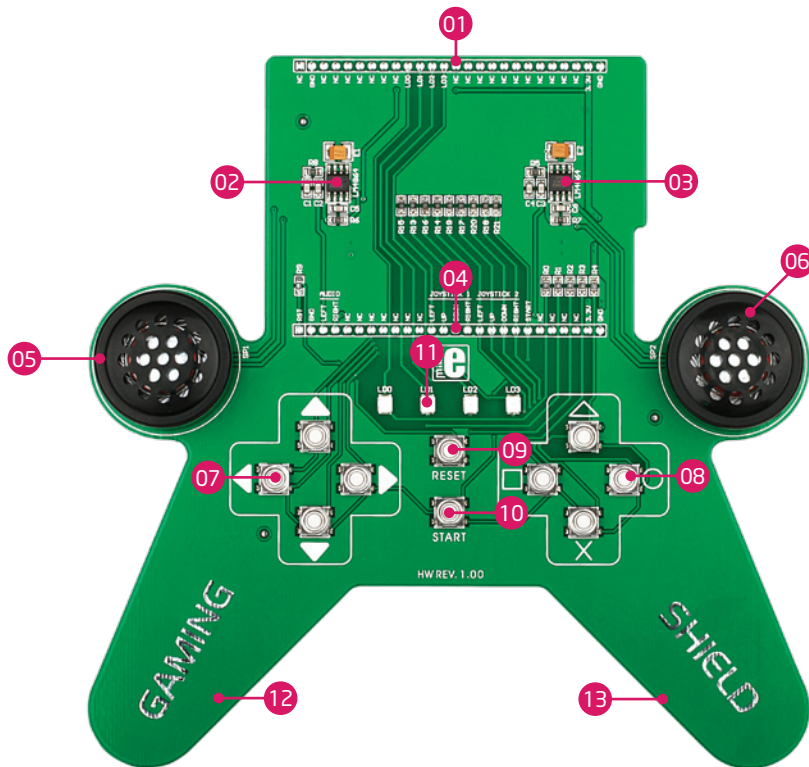



## System Specification



### power supply

Over a USB cable (5V DC)



### power consumption

50mA in idle state  
(when on-board modules are off)



### board dimensions

15.2 x 15.1cm (5.98" x 5.94")



### weight

~74g (0.16 lbs)

# 1. Soldering stacking headers

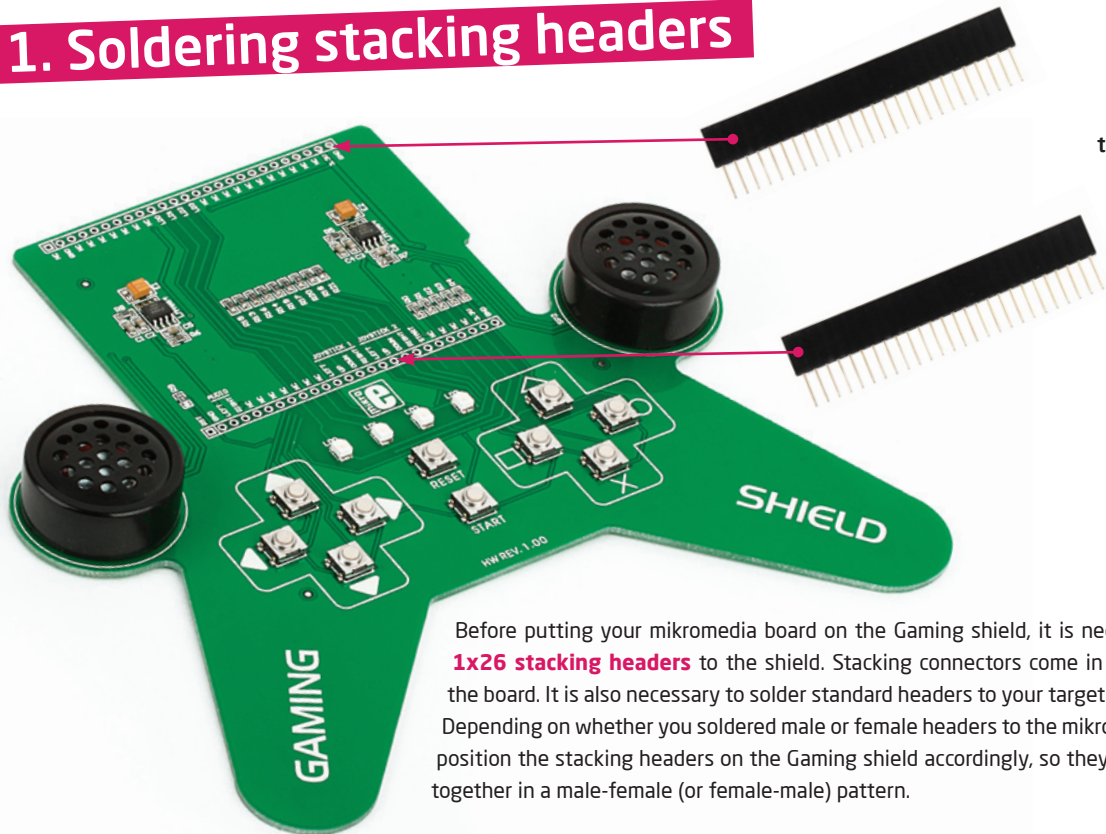

Figure 1-1:  
Positioning  
the stacking  
headers

Before putting your mikromedia board on the Gaming shield, it is necessary to solder **1x26 stacking headers** to the shield. Stacking connectors come in the package with the board. It is also necessary to solder standard headers to your target mikromedia board. Depending on whether you soldered male or female headers to the mikromedia, you should position the stacking headers on the Gaming shield accordingly, so they can be connected together in a male-female (or female-male) pattern.



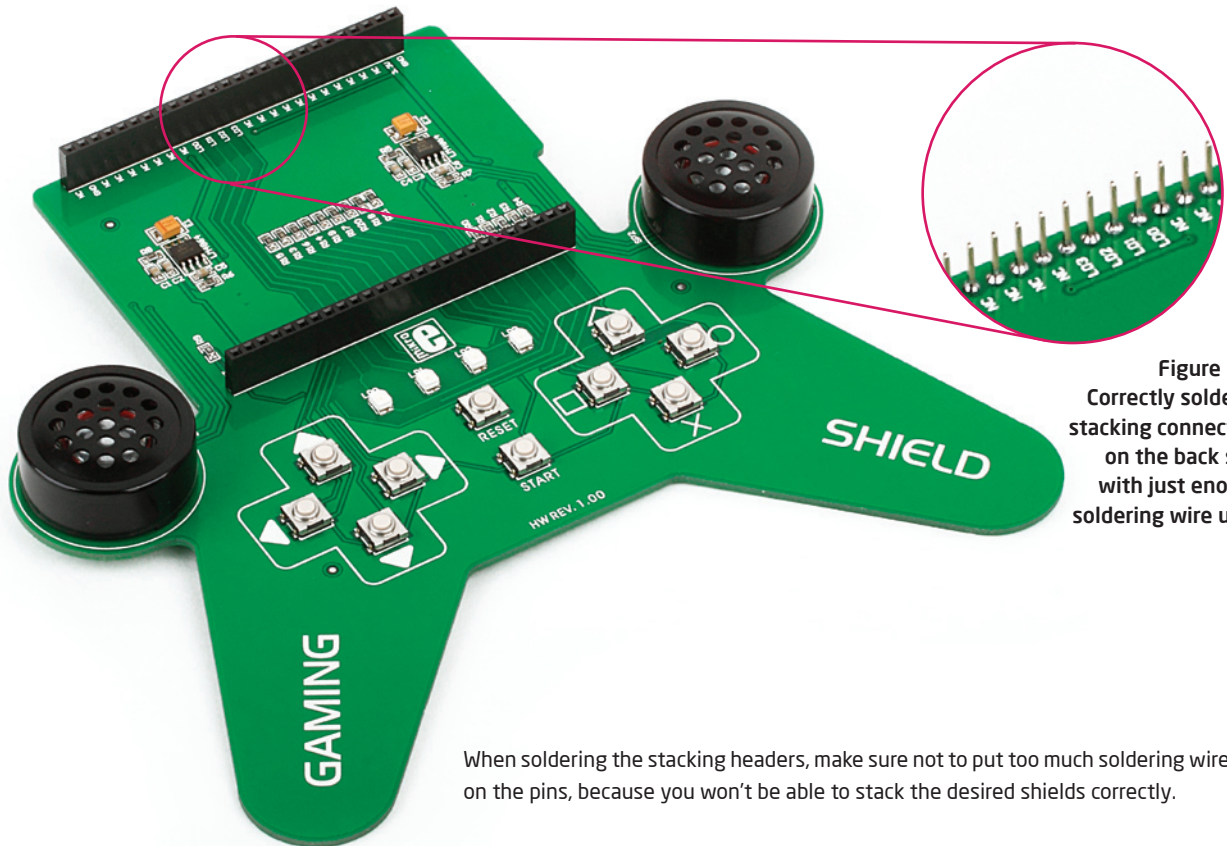

Figure 1-2:  
Correctly soldered  
stacking connectors  
on the back side  
with just enough  
soldering wire used

When soldering the stacking headers, make sure not to put too much soldering wire on the pins, because you won't be able to stack the desired shields correctly.

## 2. Connecting to mikromedias

Once you have soldered the stacking headers, you can connect your mikromedia to the gaming shield. Make sure to connect the boards so that the shapes of mikromedia and top of the gaming shields are aligned.

**Figure 2-1: mikromedia board correctly placed on the gaming shield**

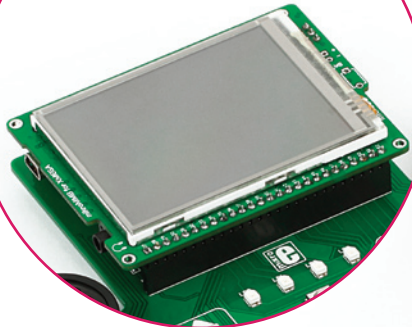

### 3. Connecting to other shields

When front side is connected with mikromedia, the rear side of the board can be used for stacking other mikromedia shields, such as the **Battery Boost shield**. Make sure to solder the appropriate headers to this add-on shield, and make sure to match the board outlines when connecting them together.

Figure 3-1: Battery Boost shield correctly placed on the gaming shield

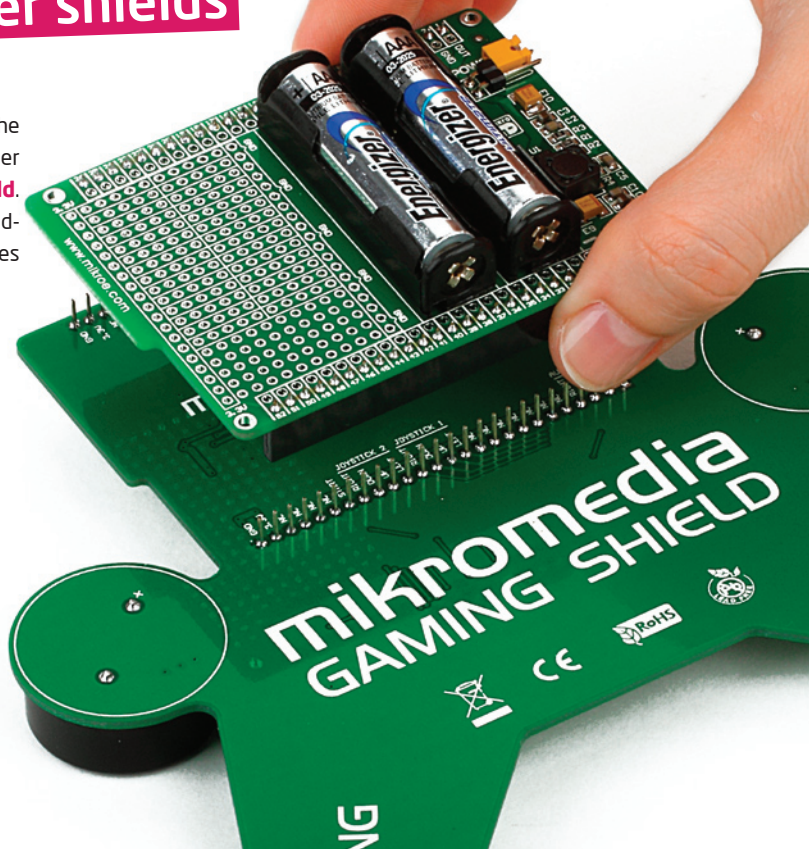
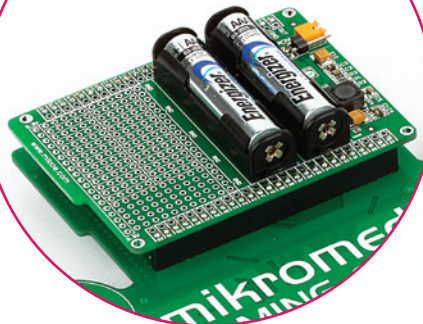



## 4. Control Buttons and signal LEDs

mikromedia Gaming shield provides standard button controls required in most arcade games. There are two sections of buttons for standard gaming functions: **steering** (left, right, up, down), **actions** (triangle, square, x, and circle), but we also added **Start** and **Reset** buttons. Board features four signal LEDs which can be used as indicators of game status, or other activities.

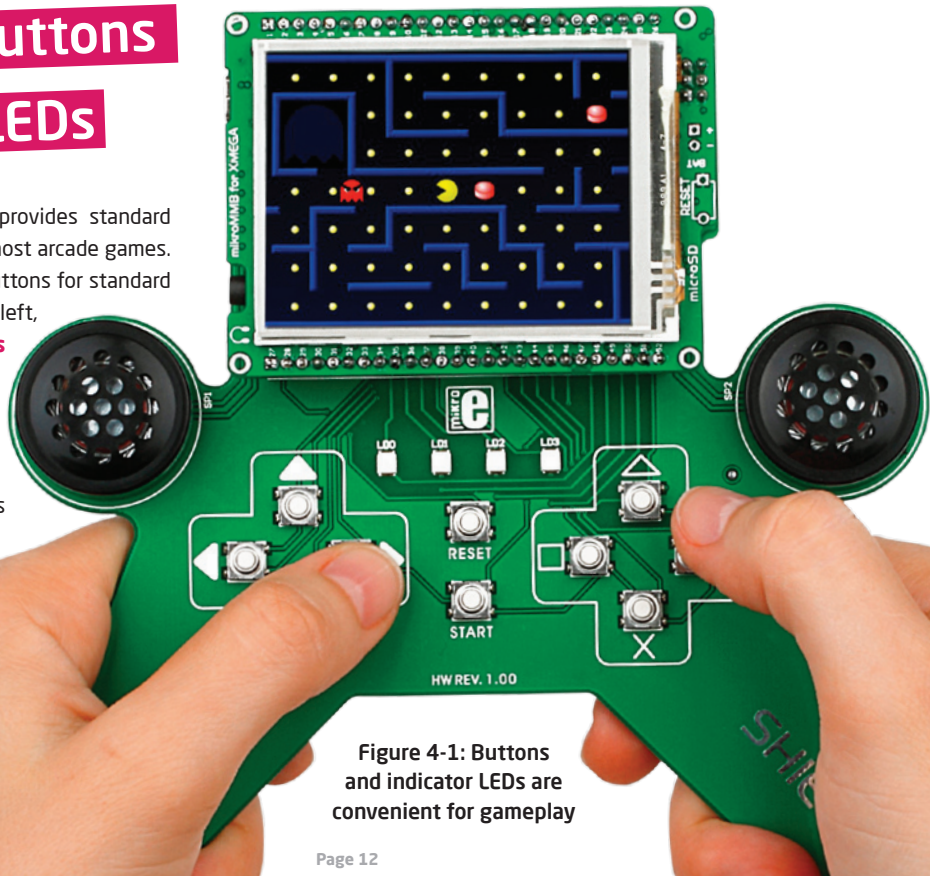

Figure 4-1: Buttons and indicator LEDs are convenient for gameplay

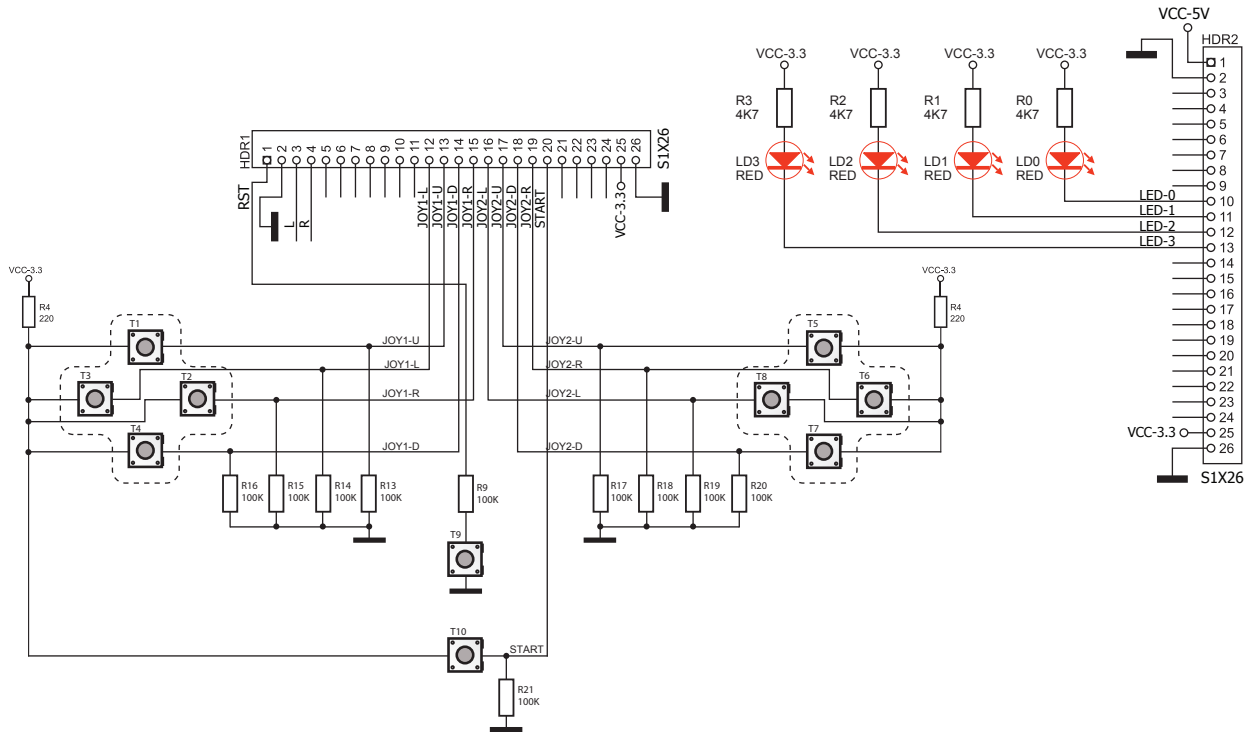

Figure 4-2: Schematics of button and LED connections

## 5. Audio module

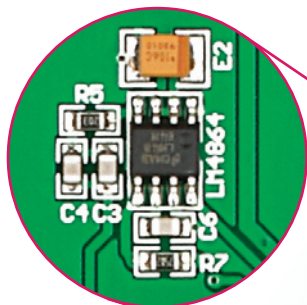
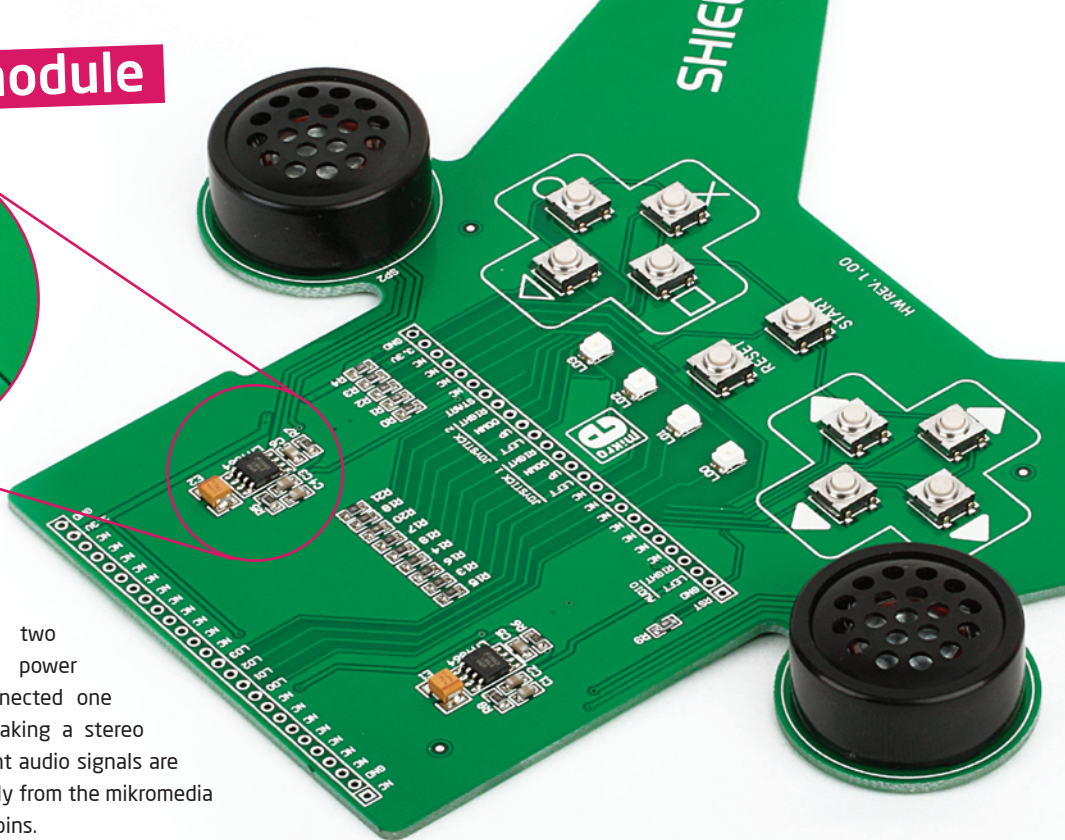

Figure 5-1:  
LM4864 audio  
amplifier circuit

Board is equipped with two **LM4864** 300mW audio power amplifiers, which are connected one to each speakers, thus making a stereo audio system. Left and right audio signals are brought to the board directly from the mikromedia board via two connections pins.



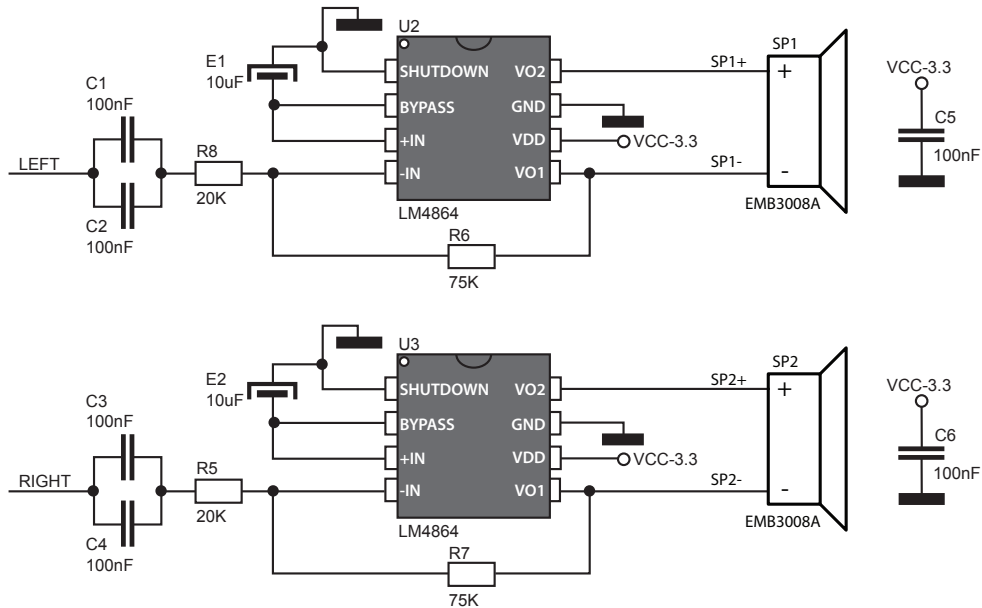
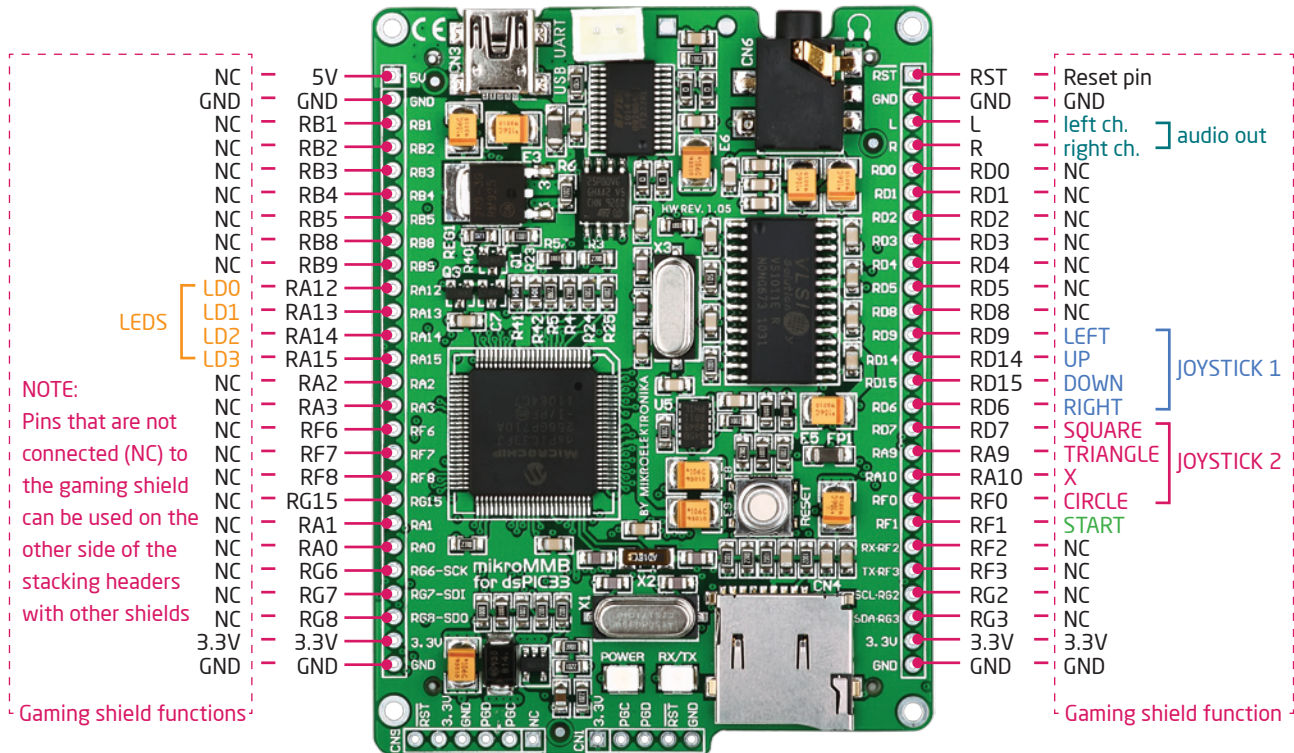

Figure 5-2: Left and right audio amplifier circuit schematics





# Gaming pinout on mikromedia for dsPIC33





# 7. Dimensions

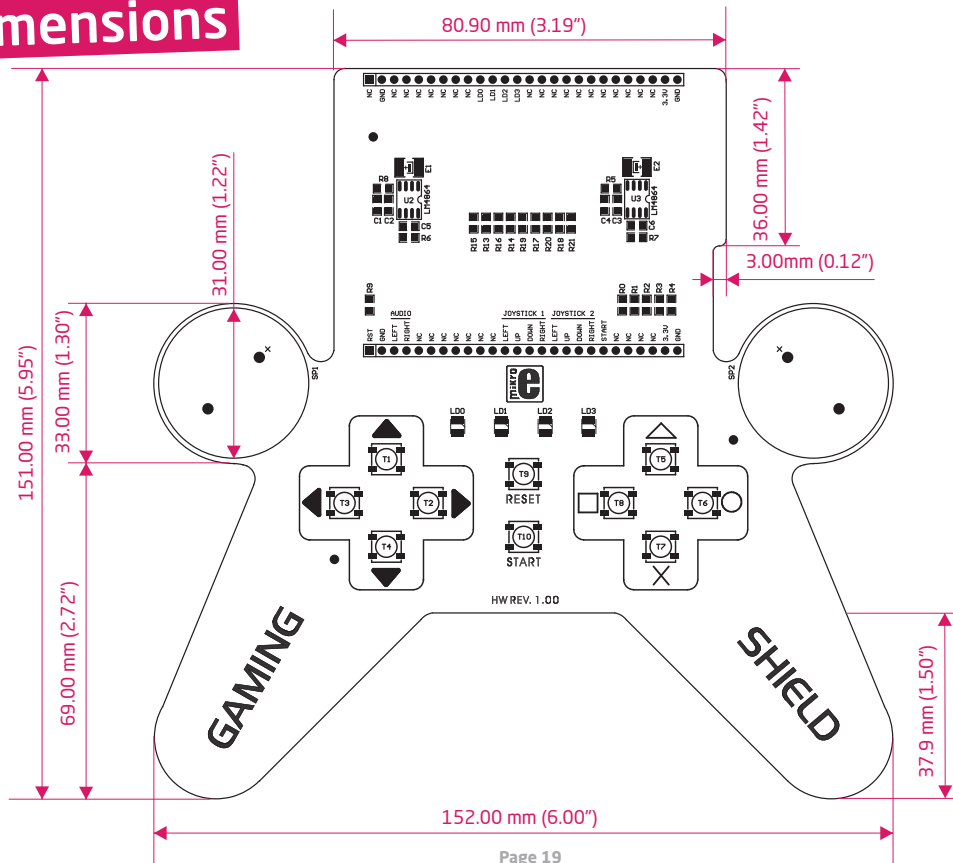

Notes:

Notes:

Notes:

## DISCLAIMER

All the products owned by MikroElektronika are protected by copyright law and international copyright treaty. Therefore, this manual is to be treated as any other copyright material. No part of this manual, including product and software described herein, may be reproduced, stored in a retrieval system, translated or transmitted in any form or by any means, without the prior written permission of MikroElektronika. The manual PDF edition can be printed for private or local use, but not for distribution. Any modification of this manual is prohibited.

MikroElektronika provides this manual 'as is' without warranty of any kind, either expressed or implied, including, but not limited to, the implied warranties or conditions of merchantability or fitness for a particular purpose.

MikroElektronika shall assume no responsibility or liability for any errors, omissions and inaccuracies that may appear in this manual. In no event shall MikroElektronika, its directors, officers, employees or distributors be liable for any indirect, specific, incidental or consequential damages (including damages for loss of business profits and business information, business interruption or any other pecuniary loss) arising out of the use of this manual or product, even if MikroElektronika has been advised of the possibility of such damages. MikroElektronika reserves the right to change information contained in this manual at any time without prior notice, if necessary.

## HIGH RISK ACTIVITIES

The products of MikroElektronika are not fault - tolerant nor designed, manufactured or intended for use or resale as on - line control equipment in hazardous environments requiring fail - safe performance, such as in the operation of nuclear facilities, aircraft navigation or communication systems, air traffic control, direct life support machines or weapons systems in which the failure of Software could lead directly to death, personal injury or severe physical or environmental damage ('High Risk Activities'). MikroElektronika and its suppliers specifically disclaim any expressed or implied warranty of fitness for High Risk Activities.

## TRADEMARKS

The Mikroelektronika name and logo, the Mikroelektronika logo, mikroC, mikroC PRO, mikroBasic, mikroBasic PRO, mikroPascal, mikroPascal PRO, AVRflash, PICflash, dsPICprog, 18FJprog, PSOCprog, AVRprog, 8051prog, ARMflash, EasyPIC5, EasyPIC6, BigPIC5, BigPIC6, dsPIC PRO4, Easy8051B, EasyARM, EasyAVR5, EasyAVR6, BigAVR2, EasydsPIC4A, EasyPSoc4, EasyVR Stamp LV18FJ, LV24-33A, LV32MX, PIC32MX4 MultiMedia Board, PICPLC16, PICPLC8 PICPLC4, SmartGSM/GPRS, UNI-DS are trademarks of Mikroelektronika. All other trademarks mentioned herein are property of their respective companies.

All other product and corporate names appearing in this manual may or may not be registered trademarks or copyrights of their respective companies, and are only used for identification or explanation and to the owners' benefit, with no intent to infringe.



If you want to learn more about our products, please visit our website at [www.mikroe.com](http://www.mikroe.com)

If you are experiencing some problems with any of our products or just need additional information, please place your ticket at [www.mikroe.com/en/support](http://www.mikroe.com/en/support)

If you have any questions, comments or business proposals,  
do not hesitate to contact us at [office@mikroe.com](mailto:office@mikroe.com)





Компания «ЭлектроПласт» предлагает заключение долгосрочных отношений при поставках импортных электронных компонентов на взаимовыгодных условиях!

Наши преимущества:

- Оперативные поставки широкого спектра электронных компонентов отечественного и импортного производства напрямую от производителей и с крупнейших мировых складов;
- Поставка более 17-ти миллионов наименований электронных компонентов;
- Поставка сложных, дефицитных, либо снятых с производства позиций;
- Оперативные сроки поставки под заказ (от 5 рабочих дней);
- Экспресс доставка в любую точку России;
- Техническая поддержка проекта, помощь в подборе аналогов, поставка прототипов;
- Система менеджмента качества сертифицирована по Международному стандарту ISO 9001;
- Лицензия ФСБ на осуществление работ с использованием сведений, составляющих государственную тайну;
- Поставка специализированных компонентов (Xilinx, Altera, Analog Devices, Intersil, Interpoint, Microsemi, Aeroflex, Peregrine, Syfer, Eurofarad, Texas Instrument, Miteq, Cobham, E2V, MA-COM, Hittite, Mini-Circuits, General Dynamics и др.);

Помимо этого, одним из направлений компании «ЭлектроПласт» является направление «Источники питания». Мы предлагаем Вам помощь Конструкторского отдела:

- Подбор оптимального решения, техническое обоснование при выборе компонента;
- Подбор аналогов;
- Консультации по применению компонента;
- Поставка образцов и прототипов;
- Техническая поддержка проекта;
- Защита от снятия компонента с производства.



#### Как с нами связаться

**Телефон:** 8 (812) 309 58 32 (многоканальный)

**Факс:** 8 (812) 320-02-42

**Электронная почта:** [org@eplast1.ru](mailto:org@eplast1.ru)

**Адрес:** 198099, г. Санкт-Петербург, ул. Калинина, дом 2, корпус 4, литера А.