



00-9176-00X-7XX-XX6

PREFIX

SERIES

NO. OF WAYS

| CODE | NO. OF WAYS |
|------|-------------|
| 001 | 1 |
| 002 | 2 |
| 003 | 3 |

WIRE GAUGE SIZE

| CODE | DESCRIPTION | ACCEPTED WIRE GAUGE | WIRE INSULATION |
|------|----------------------|---------------------|-----------------|
| 701 | CAPPED-IDC CONNECTOR | 18 AWG STRANDED | Ø 1.6-2.1 |
| 711 | | 20 AWG STRANDED | Ø 1.6-2.1 |
| 722 | | 22 AWG STRANDED | Ø 1.1-1.6 |
| 732 | | 24 AWG STRANDED | Ø 1.1-1.6 |

Elco Europe (A Division of AVX Ltd) CONFIDENTIAL PROPRIETY
The document on this print and information therewith are PROPRIETY
to Elco Europe (A Division of AVX Ltd) and shall not be copied
or disclosed in whole or in part without Elco Europe's written consent.

COLOUR OPTION

| CODE | INSULATOR COLOUR | AVAILABILITY |
|------|------------------|---------------|
| 0 | BLACK | SPECIAL ORDER |
| 1 | WHITE | STANDARD |

CAP OPTIONS

| CODE | CAP OPTION | DESCRIPTION | DETAILS |
|------|--------------|---|------------------------|
| 0 | THROUGH WIRE | ALLOWS WIRE TO BE TERMINATED AT ANY POINT | REFER TO SHEETS 2 TO 4 |
| 9 | WIRE STOP | TERMINATES END OF WIRE END PROTECTED BY STOP FACE | REFER TO SHEETS 5 TO 7 |

PLATING OPTION

| CODE | DESCRIPTION |
|------|-------------------|
| 6 | PURE TIN ALL OVER |

AVX CONTROLLED RELEASE

FORM-106-01-036-6 ISS 7

ELCO EUROPE (A DIVISION OF AVX LTD.) CONFIDENTIAL PROPRIETY
THE DRAWING ON THIS PRINT AND INFORMATION THEREWITH ARE PROPRIETARY TO ELCO EUROPE (A DIVISION OF AVX LTD.) AND SHALL NOT BE USED OR DISCLOSED IN WHOLE OR IN PART WITHOUT ELCO EUROPE'S WRITTEN CONSENT.

SHEET 1 OF 8

Release No.
History
102847
04.05.2012
18.05.2012
20.08.2012

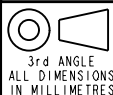

ELCO

© COPYRIGHT ELCO EUROPE
NOT TO BE DISCLOSED OR COPIED
WITHOUT WRITTEN PERMISSION

Drawn
N.C.H.
Size
CV

Description
18-24AWG IDC WIRE TO BOARD CONNECTOR
Part Number
00-9176-01_700S

DATE
04-Apr-12
Issue
C



**18-24 AWG 1 WAY IDC CONNECTOR
THROUGH WIRE CAPPED IDC**

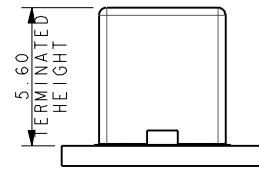
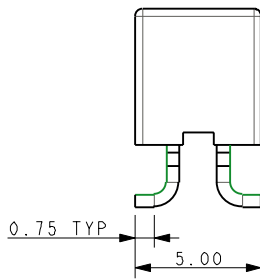
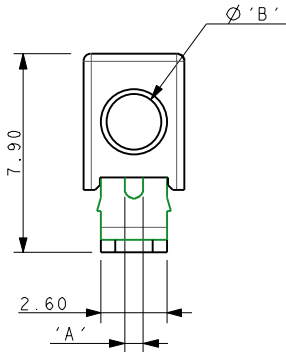
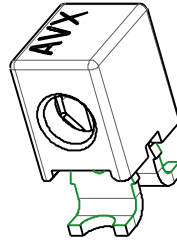
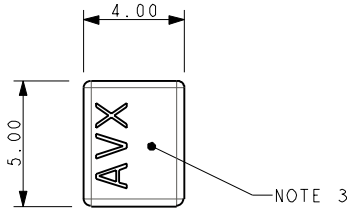

MOUNTED ON PCB

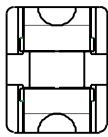

| CODE | WIRE GAUGE | 'A' | WIRE INSULATION | 'B' |
|------|----------------|------|-----------------|-----|
| 701 | 18AWG STRANDED | 0.74 | Ø 1.6-2.1 | 2.1 |
| 711 | 20AWG STRANDED | 0.60 | Ø 1.6-2.1 | 2.1 |
| 722 | 22AWG STRANDED | 0.47 | Ø 1.1-1.6 | 1.6 |
| 732 | 24AWG STRANDED | 0.37 | Ø 1.1-1.6 | 1.6 |

Elco Europe (A Division of AVX Ltd) CONFIDENTIAL PROPRIETY
The document on this print and information therewith are PROPRIETY
to Elco Europe (A Division of AVX Ltd) and shall not be copied
or disclosed in whole or in part without Elco Europe's written consent.

PACKING NOTES

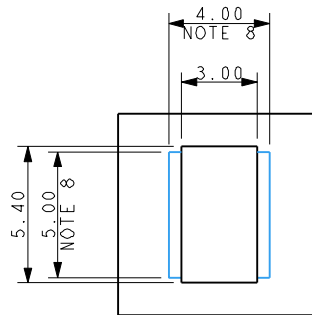
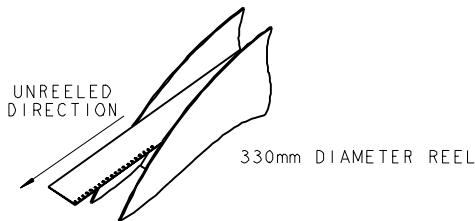

SUGGESTED PCB LAYOUT

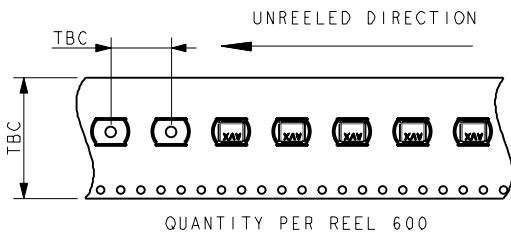

QUANTITY PER REEL 600

NOTES :-

1. 1 WAY CONNECTOR FOR IDC WIRE TO BOARD CONNECTION, PRE ASSEMBLED THROUGH WIRE CAP, CODE REFER TO SHEET 1.
2. CONTACT/CAP TO MATCH 18-24AWG STRANDED WIRE, INSULATION DIAMETER RANGE AS IN TABLE.
3. FLAT FACE ON TOP OF CAP TO AID PICK AND PLACE ASSEMBLY.
4. FOR FULL DETAILS REFER TO ELCO SPECIFICATION 201-01-138.
5. ASSEMBLY PROCEDURE, REFER TO APPLICATION NOTES 201-01-140.
6. GENERAL TOLERANCE ±0.20 UNLESS STATED.
7. PACKED IN TAPE AND REEL, QUANTITY PER REEL 600.
8. CONNECTOR OUTLINE.
9. CONTACT MATERIAL :- TIN PLATED COPPER ALLOY.
10. INSULATION MATERIAL, HIGH TEMPERATURE NYLON, GLASS FILLED. UL94 V-0, COLOUR REFER TO SHEET 1.
11. GENERAL TOLERANCE ±0.20 UNLESS STATED.

FORM-106-01-056-6 ISS 7

ELCO EUROPE (A DIVISION OF AVX LTD.) CONFIDENTIAL PROPRIETY
 THE DRAWING ON THIS PRINT AND INFORMATION THEREWITH ARE PROPRIETARY TO ELCO EUROPE (A DIVISION OF AVX LTD.) AND SHALL NOT BE USED OR DISCLOSED IN WHOLE OR IN PART WITHOUT ELCO EUROPE'S WRITTEN CONSENT.

SHEET 2 OF 8

| | |
|-----------------------|---|
| Release No. 102847 | History 04.05.2012 18.05.2012 20.08.2012 |
|-----------------------|---|



| | | |
|-----------------|---|-------------------|
| Drawn N.C.H. | Description 18-24AWG IDC WIRE TO BOARD CONNECTOR | DATE 04-Apr-12 |
| Size CV | Part Number 00-9176-01_700S | Issue C |

A

B



**18-24 AWG 2 WAY IDC CONNECTOR
THROUGH WIRE CAPPED IDC**

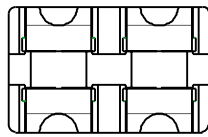
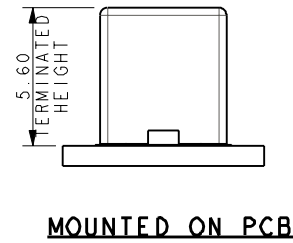
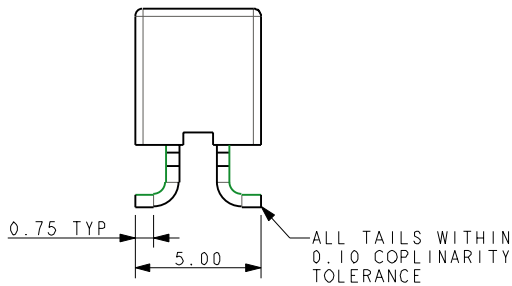
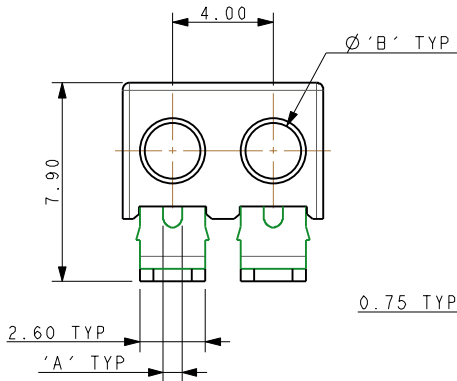
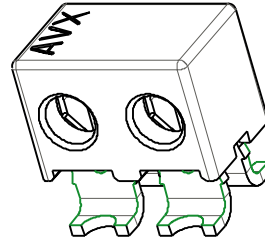
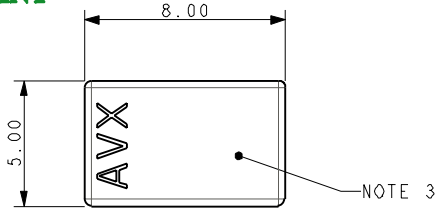

| CODE | WIRE GAUGE | 'A' | WIRE INSULATION | 'B' |
|------|----------------|------|-----------------|-----|
| 701 | 18AWG STRANDED | 0.74 | Ø 1.6-2.1 | 2.1 |
| 711 | 20AWG STRANDED | 0.60 | Ø 1.6-2.1 | 2.1 |
| 722 | 22AWG STRANDED | 0.47 | Ø 1.1-1.6 | 1.6 |
| 732 | 24AWG STRANDED | 0.37 | Ø 1.1-1.6 | 1.6 |

Elco Europe (A Division of AVX Ltd) CONFIDENTIAL PROPRIETY
The document on this print and information therewith are PROPRIETY
to Elco Europe (A Division of AVX Ltd) and shall not be copied
or disclosed in whole or in part without Elco Europe's written consent.

PACKING NOTES

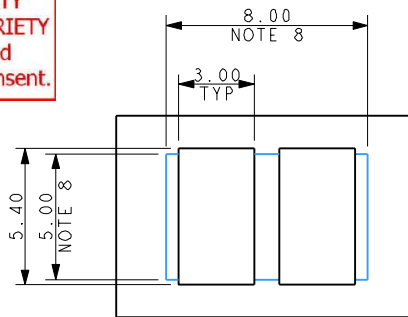
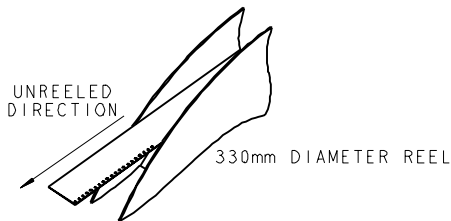

SUGGESTED PCB LAYOUT

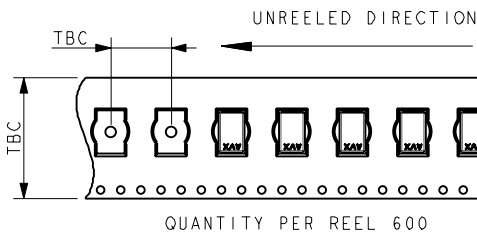

NOTES :-

- 2 WAY CONNECTOR FOR IDC WIRE TO BOARD CONNECTION, PRE ASSEMBLED THROUGH WIRE CAP, CODE REFER TO SHEET 1.
- CONTACT/CAP TO MATCH 18-24AWG STRANDED WIRE, INSULATION DIAMETER RANGE AS IN TABLE.
- FLAT FACE ON TOP OF CAP TO AID PICK AND PLACE ASSEMBLY.
- FOR FULL DETAILS REFER TO ELCO SPECIFICATION 201-01-138.
- ASSEMBLY PROCEDURE, REFER TO APPLICATION NOTES 201-01-140.
- GENERAL TOLERANCE ±0.20 UNLESS STATED.
- PACKED IN TAPE AND REEL, QUANTITY PER REEL 600.
- CONNECTOR OUTLINE.
- CONTACT MATERIAL :- TIN PLATED COPPER ALLOY.
- INSULATION MATERIAL, HIGH TEMPERATURE NYLON, GLASS FILLED.
- UL94 V-0, COLOUR REFER TO SHEET 1.
- GENERAL TOLERANCE ±0.20 UNLESS STATED.

ELCO EUROPE (A DIVISION OF AVX LTD.) CONFIDENTIAL PROPRIETY
THE DRAWING ON THIS PRINT AND INFORMATION THEREWITH ARE
PROPRIETARY TO ELCO EUROPE (A DIVISION OF AVX LTD.) AND
SHALL NOT BE USED OR DISCLOSED IN WHOLE OR IN PART
WITHOUT ELCO EUROPE'S WRITTEN CONSENT.

SHEET 3 OF 8

FORM-106-01-056-6 ISS 7
Release No.
History
102847
04.05.2012
18.05.2012
20.08.2012

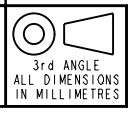

ELCO
© COPYRIGHT ELCO EUROPE
NOT TO BE DISCLOSED OR COPIED
WITHOUT WRITTEN PERMISSION

| | | |
|-----------------|---|-------------------|
| Drawn N.C.H. | Description 18-24AWG IDC WIRE TO BOARD CONNECTOR | DATE 04-Apr-12 |
| Size CV | Part Number 00-9176-01_700S | Issue C |

A

B



**18-24 AWG 3 WAY IDC CONNECTOR
THROUGH WIRE CAPPED IDC**

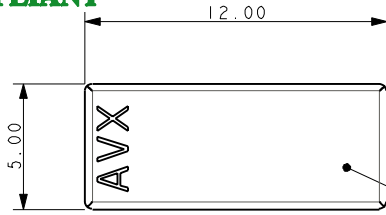

NOTES 3

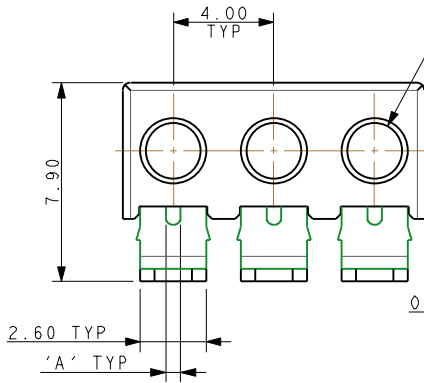
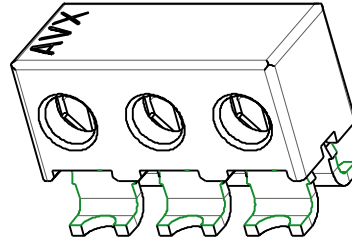

Ø 'B' TYP

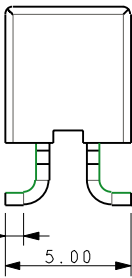

ALL TAILS WITHIN 0.10 COPLANARITY TOLERANCE

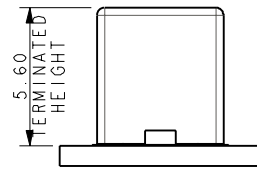

MOUNTED ON PCB

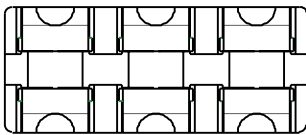

| CODE | WIRE GAUGE | 'A' | WIRE INSULATION | 'B' |
|------|----------------|------|-----------------|-----|
| 701 | 18AWG STRANDED | 0.74 | Ø 1.6-2.1 | 2.1 |
| 711 | 20AWG STRANDED | 0.60 | Ø 1.6-2.1 | 2.1 |
| 722 | 22AWG STRANDED | 0.47 | Ø 1.1-1.6 | 1.6 |
| 732 | 24AWG STRANDED | 0.37 | Ø 1.1-1.6 | 1.6 |

Elco Europe (A Division of AVX Ltd) CONFIDENTIAL PROPRIETY
The document on this print and information therewith are PROPRIETY
to Elco Europe (A Division of AVX Ltd) and shall not be copied
or disclosed in whole or in part without Elco Europe's written consent.

PACKING NOTES

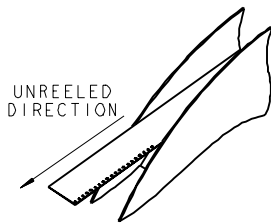

330mm DIAMETER REEL

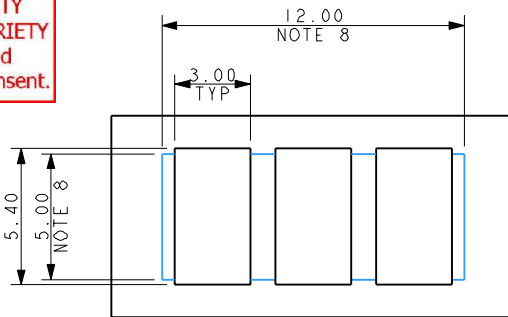

SUGGESTED PCB LAYOUT

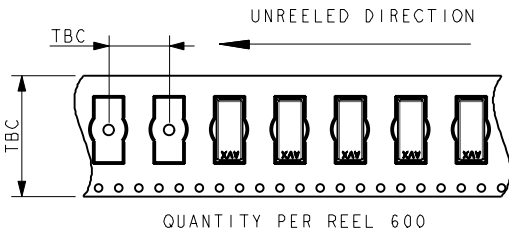

QUANTITY PER REEL 600

NOTES :-

- 3 WAY CONNECTOR FOR IDC WIRE TO BOARD CONNECTION, PRE ASSEMBLED THROUGH WIRE CAP, CODE REFER TO SHEET 1.
- CONTACT/CAP TO MATCH 18-24AWG STRANDED WIRE, INSULATION DIAMETER RANGE AS IN TABLE.
- FLAT FACE ON TOP OF CAP TO AID PICK AND PLACE ASSEMBLY.
- FOR FULL DETAILS REFER TO ELCO SPECIFICATION 201-01-138.
- ASSEMBLY PROCEDURE, REFER TO APPLICATION NOTES 201-01-140.
- GENERAL TOLERANCE ±0.20 UNLESS STATED.
- PACKED IN TAPE AND REEL, QUANTITY PER REEL 600.
- CONNECTOR OUTLINE.
- CONTACT MATERIAL :- TIN PLATED COPPER ALLOY.
- INSULATION MATERIAL, HIGH TEMPERATURE NYLON, GLASS FILLED.
- UL94 V-0, COLOUR REFER TO SHEET 1.
- GENERAL TOLERANCE ±0.20 UNLESS STATED.

ELCO EUROPE (A DIVISION OF AVX LTD.) CONFIDENTIAL PROPRIETY
 THE DRAWING ON THIS PRINT AND INFORMATION THEREWITH ARE PROPRIETARY TO ELCO EUROPE (A DIVISION OF AVX LTD.) AND SHALL NOT BE USED OR DISCLOSED IN WHOLE OR IN PART WITHOUT ELCO EUROPE'S WRITTEN CONSENT.

SHEET 4 OF 8

Release No.
 History
 102847
 04.05.2012
 18.05.2012
 20.08.2012

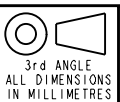

| | | |
|-----------------|---|-------------------|
| Drawn N.C.H. | Description 18-24AWG IDC WIRE TO BOARD CONNECTOR | DATE 04-Apr-12 |
| Size CV | Part Number 00-9176-01_700S | Issue C |

A

B



**18-24 AWG 1 WAY IDC CONNECTOR
WIRE STOP CAPPED-IDC**

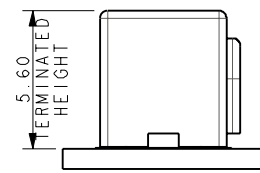
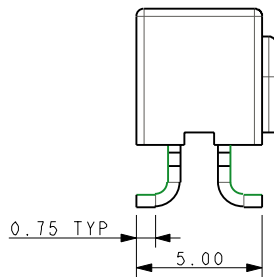
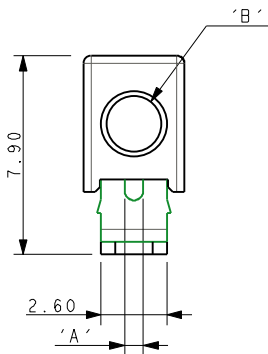
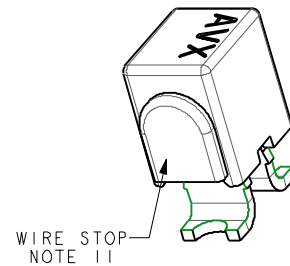
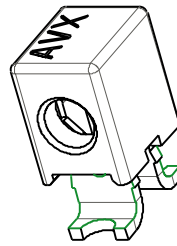
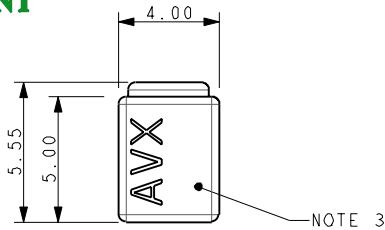

MOUNTED ON PCB

| CODE | WIRE GAUGE | 'A' | WIRE INSULATION | 'B' |
|------|----------------|------|-----------------|-----|
| 701 | 18AWG STRANDED | 0.74 | Ø 1.6-2.1 | 2.1 |
| 711 | 20AWG STRANDED | 0.60 | Ø 1.6-2.1 | 2.1 |
| 722 | 22AWG STRANDED | 0.47 | Ø 1.1-1.6 | 1.6 |
| 732 | 24AWG STRANDED | 0.37 | Ø 1.1-1.6 | 1.6 |

Elco Europe (A Division of AVX Ltd) CONFIDENTIAL PROPRIETY
The document on this print and information therewith are PROPRIETY
to Elco Europe (A Division of AVX Ltd) and shall not be copied
or disclosed in whole or in part without Elco Europe's written consent.

PACKING NOTES

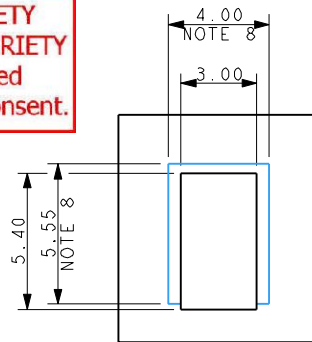
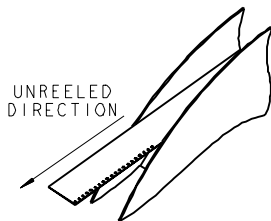

SUGGESTED PCB LAYOUT

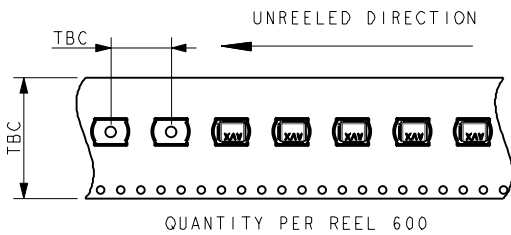

NOTES :-

1. 1 WAY CONNECTOR FOR IDC WIRE TO BOARD CONNECTION, PRE ASSEMBLED WIRE STOP CAP, CODE REFER TO SHEET 1.
2. CONTACT/CAP TO MATCH 18-24AWG STRANDED WIRE, INSULATION DIAMETER RANGE AS IN TABLE.
3. FLAT FACE ON TOP OF CAP TO AID PICK AND PLACE ASSEMBLY.
4. FOR FULL DETAILS REFER TO ELCO SPECIFICATION 201-01-138.
5. ASSEMBLY PROCEDURE, REFER TO APPLICATION NOTES 201-01-140.
6. GENERAL TOLERANCE ±0.20 UNLESS STATED.
7. PACKED IN TAPE AND REEL, QUANTITY PER REEL 600.
8. CONNECTOR OUTLINE.
9. CONTACT MATERIAL :- TIN PLATED COPPER ALLOY.
10. INSULATION MATERIAL, HIGH TEMPERATURE NYLON, GLASS FILLED, UL94 V-0, COLOUR REFER TO SHEET 1.
11. WIRE STOP CAP PROTECTS END OF WIRE.
12. GENERAL TOLERANCE ±0.20 UNLESS STATED.

FORM-106-01-056-6 ISS 7

ELCO EUROPE (A DIVISION OF AVX LTD.) CONFIDENTIAL PROPRIETY
 THE DRAWING ON THIS PRINT AND INFORMATION THERWITH ARE PROPRIETY TO ELCO EUROPE (A DIVISION OF AVX LTD.) AND SHALL NOT BE USED OR DISCLOSED IN WHOLE OR IN PART WITHOUT ELCO EUROPE'S WRITTEN CONSENT.

SHEET 5 OF 8

| | |
|-----------------------|---|
| Release No. 102847 | History 04.05.2012 18.05.2012 20.08.2012 |
|-----------------------|---|



| | | |
|-----------------|---|-------------------|
| Drawn N.C.H. | Description 18-24AWG IDC WIRE TO BOARD CONNECTOR | DATE 04-Apr-12 |
| Size CV | Part Number 00-9176-01_700S | Issue C |

A

B



**18-24 AWG 2 WAY IDC CONNECTOR
WIRE STOP CAPPED IDC**

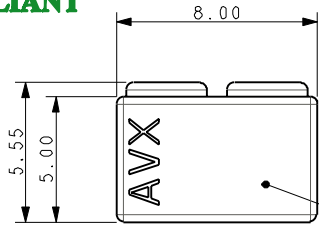

NOTE 3

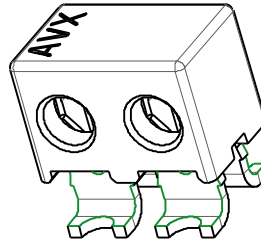

WIRE STOP
NOTE 11

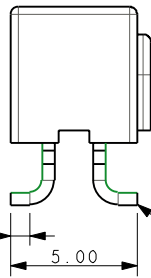
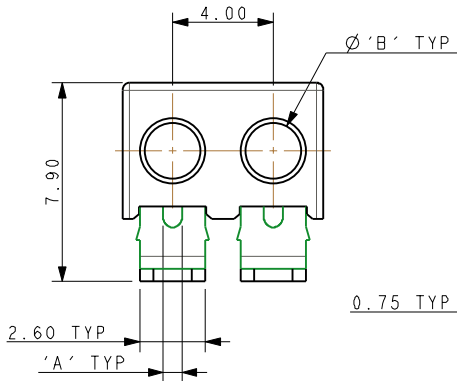
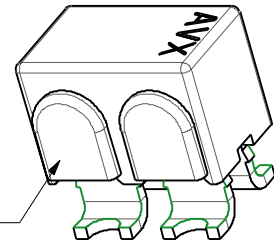

ALL TAILS WITHIN
0.10 COPLANARITY
TOLERANCE

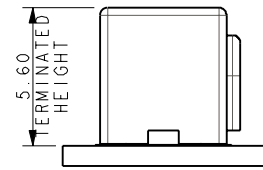

MOUNTED ON PCB

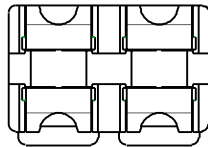

| CODE | WIRE GAUGE | 'A' | WIRE INSULATION | 'B' |
|------|----------------|------|-----------------|-----|
| 701 | 18AWG STRANDED | 0.74 | Ø 1.6-2.1 | 2.1 |
| 711 | 20AWG STRANDED | 0.60 | Ø 1.6-2.1 | 2.1 |
| 722 | 22AWG STRANDED | 0.47 | Ø 1.1-1.6 | 1.6 |
| 732 | 24AWG STRANDED | 0.37 | Ø 1.1-1.6 | 1.6 |

Elco Europe (A Division of AVX Ltd) CONFIDENTIAL PROPRIETY
The document on this print and information therewith are PROPRIETY
to Elco Europe (A Division of AVX Ltd) and shall not be copied
or disclosed in whole or in part without Elco Europe's written consent.

PACKING NOTES

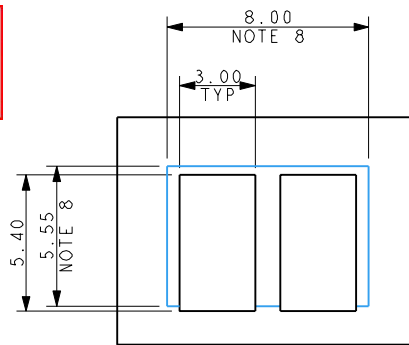
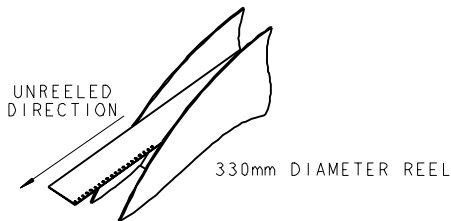

SUGGESTED PCB LAYOUT

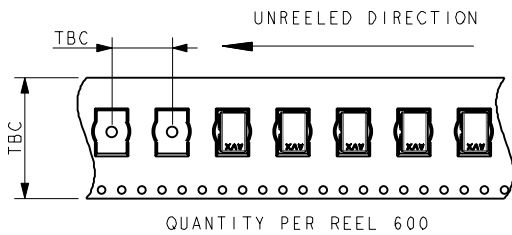

NOTES :-

- 2 WAY CONNECTOR FOR IDC WIRE TO BOARD CONNECTION, PRE ASSEMBLED WIRE STOP CAP, CODE REFER TO SHEET 1.
- CONTACT/CAP TO MATCH 18-24AWG STRANDED WIRE, INSULATION DIAMETER RANGE AS IN TABLE.
- FLAT FACE ON TOP OF CAP TO AID PICK AND PLACE ASSEMBLY.
- FOR FULL DETAILS REFER TO ELCO SPECIFICATION 201-01-138.
- ASSEMBLY PROCEDURE, REFER TO APPLICATION NOTES 201-01-140.
- GENERAL TOLERANCE ±0.20 UNLESS STATED.
- PACKED IN TAPE AND REEL, QUANTITY PER REEL 600.
- CONNECTOR OUTLINE.
- CONTACT MATERIAL :- TIN PLATED COPPER ALLOY.
- INSULATION MATERIAL, HIGH TEMPERATURE NYLON, GLASS FILLED. UL94 V-0, COLOUR REFER TO SHEET 1.
- WIRE STOP CAP PROTECTS END OF WIRE.
- GENERAL TOLERANCE ±0.20 UNLESS STATED.

SHEET 6 OF 8

FORM-106-01-056-6 ISS 7

ELCO EUROPE (A DIVISION OF AVX LTD.) CONFIDENTIAL PROPRIETY
THE DRAWING ON THIS PRINT AND INFORMATION THEREWITH ARE
PROPRIETARY TO ELCO EUROPE (A DIVISION OF AVX LTD.) AND
SHALL NOT BE USED OR DISCLOSED IN WHOLE OR IN PART
WITHOUT ELCO EUROPE'S WRITTEN CONSENT.

Release No.
History
102847
04.05.2012
18.05.2012
20.08.2012

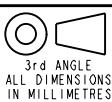

ELCO
© COPYRIGHT ELCO EUROPE
NOT TO BE DISCLOSED OR COPIED
WITHOUT WRITTEN PERMISSION

| | | |
|-----------------|---|-------------------|
| Drawn N.C.H. | Description 18-24AWG IDC WIRE TO BOARD CONNECTOR | DATE 04-Apr-12 |
| Size CV | Part Number 00-9176-01_700S | Issue C |

A

B



**18-24 AWG 3 WAY IDC CONNECTOR
WIRE STOP CAPPED IDC**

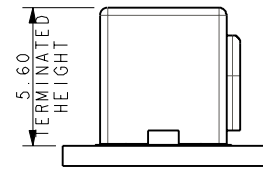
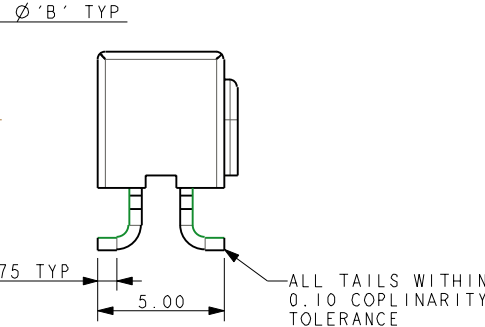
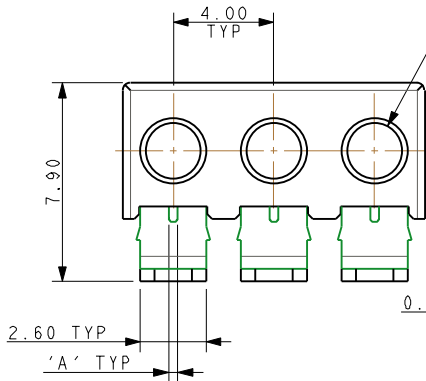
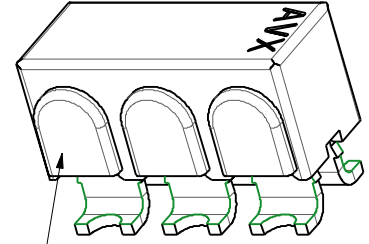
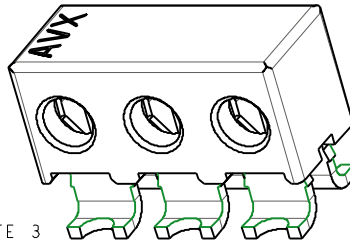
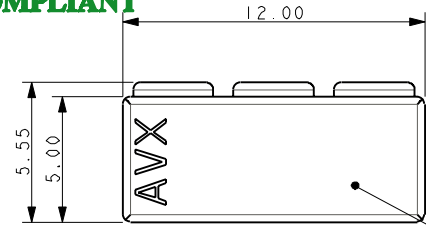

MOUNTED ON PCB

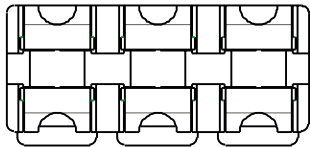

| CODE | WIRE GAUGE | 'A' | WIRE INSULATION | 'B' |
|------|----------------|------|-----------------|-----|
| 701 | 18AWG STRANDED | 0.74 | Ø 1.6-2.1 | 2.1 |
| 711 | 20AWG STRANDED | 0.60 | Ø 1.6-2.1 | 2.1 |
| 722 | 22AWG STRANDED | 0.47 | Ø 1.1-1.6 | 1.6 |
| 732 | 24AWG STRANDED | 0.37 | Ø 1.1-1.6 | 1.6 |

Elco Europe (A Division of AVX Ltd) CONFIDENTIAL PROPRIETY
The document on this print and information therewith are PROPRIETY to Elco Europe (A Division of AVX Ltd) and shall not be copied or disclosed in whole or in part without Elco Europe's written consent.

PACKING NOTES

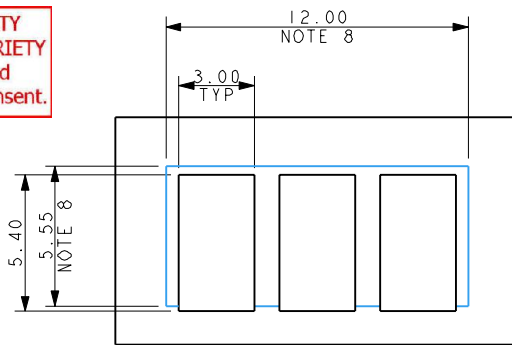
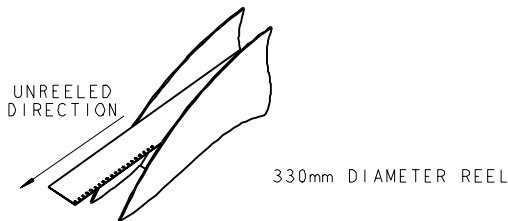

SUGGESTED PCB LAYOUT

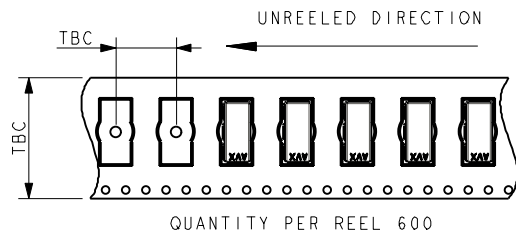

NOTES :-

- 3 WAY CONNECTOR FOR IDC WIRE TO BOARD CONNECTION, PRE ASSEMBLED WIRE STOP CAP, CODE REFER TO SHEET 1.
- CONTACT/CAP TO MATCH 18-24AWG STRANDED WIRE, INSULATION DIAMETER RANGE AS IN TABLE.
- FLAT FACE ON TOP OF CAP TO AID PICK AND PLACE ASSEMBLY.
- FOR FULL DETAILS REFER TO ELCO SPECIFICATION 201-01-138.
- ASSEMBLY PROCEDURE, REFER TO APPLICATION NOTES 201-01-140.
- GENERAL TOLERANCE ±0.20 UNLESS STATED.
- PACKED IN TAPE AND REEL, QUANTITY PER REEL 600.
- CONNECTOR OUTLINE.
- CONTACT MATERIAL :- TIN PLATED COPPER ALLOY.
- INSULATION MATERIAL, HIGH TEMPERATURE NYLON, GLASS FILLED. UL94 V-0, COLOUR REFER TO SHEET 1.
- WIRE STOP CAP PROTECTS END OF WIRE.
- GENERAL TOLERANCE ±0.20 UNLESS STATED.

SHEET 7 OF 8

FORM-106-01-056-6 ISS 7

ELCO EUROPE (A DIVISION OF AVX LTD.) CONFIDENTIAL PROPRIETY
THE DRAWING ON THIS PRINT AND INFORMATION THEREWITH ARE PROPRIETY TO ELCO EUROPE (A DIVISION OF AVX LTD.) AND SHALL NOT BE USED OR DISCLOSED IN WHOLE OR IN PART WITHOUT ELCO EUROPE'S WRITTEN CONSENT.

Release No.
History
102847
04.05.2012
18.05.2012
20.08.2012

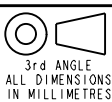

| | | |
|-----------------|---|-------------------|
| Drawn N.C.H. | Description 18-24AWG IDC WIRE TO BOARD CONNECTOR | DATE 04-Apr-12 |
| Size CV | Part Number 00-9176-01_700S | Issue C |

A

B

A

B



18-24 AWG ASSEMBLED CAPPED IDC CONNECTORS

Elco Europe (A Division of AVX Ltd) CONFIDENTIAL PROPRIETY
 The document on this print and information therewith are PROPRIETY
 to Elco Europe (A Division of AVX Ltd) and shall not be copied
 or disclosed in whole or in part without Elco Europe's written consent.

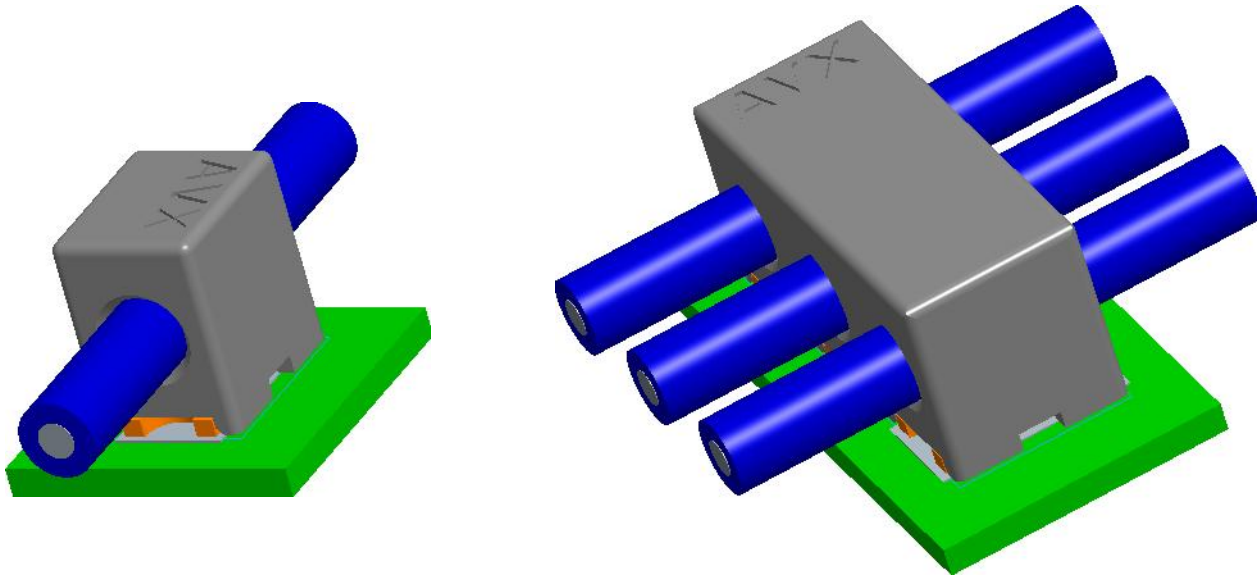

TYPICAL THROUGH WIRE ASSEMBLIES

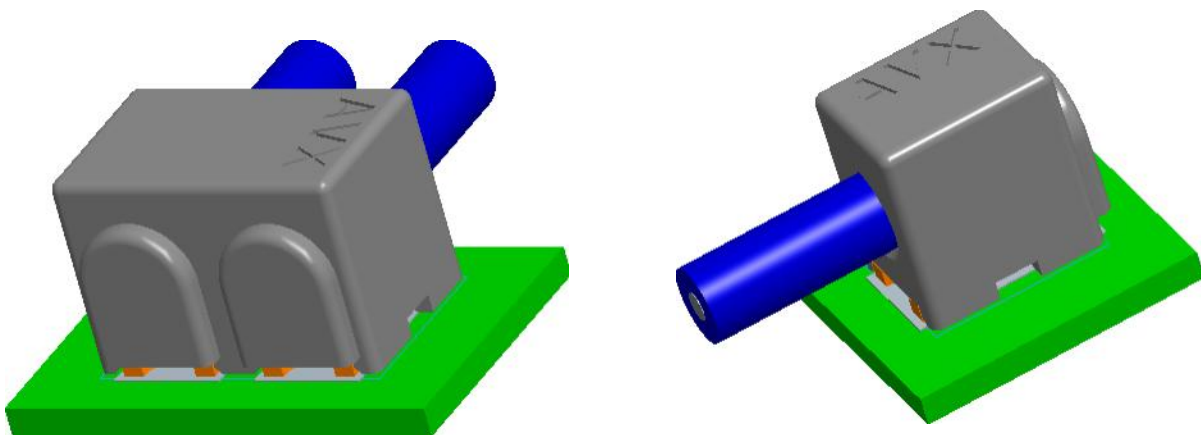

TYPICAL WIRE STOP ASSEMBLIES

FORM-106-01-036-6 ISS 7

ELCO EUROPE (A DIVISION OF AVX LTD.) CONFIDENTIAL PROPRIETY
 THE DRAWING ON THIS PRINT AND INFORMATION THEREWITH ARE
 PROPRIETARY TO ELCO EUROPE (A DIVISION OF AVX LTD.) AND
 SHALL NOT BE USED OR DISCLOSED IN WHOLE OR IN PART
 WITHOUT ELCO EUROPE'S WRITTEN CONSENT.

SHEET 8 OF 8

Release No.
 History
 102847
 04.05.2012
 18.05.2012
 20.08.2012

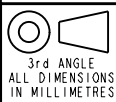

ELCO
 © COPYRIGHT ELCO EUROPE
 NOT TO BE DISCLOSED OR COPIED
 WITHOUT WRITTEN PERMISSION

Drawn
 N.C.H.
 Size
 CV

Description
 18-24AWG IDC WIRE TO BOARD CONNECTOR
 Part Number
 00-9176-01_700S

DATE
 04-Apr-12
 Issue
 C

A

B



Компания «ЭлектроПласт» предлагает заключение долгосрочных отношений при поставках импортных электронных компонентов на взаимовыгодных условиях!

Наши преимущества:

- Оперативные поставки широкого спектра электронных компонентов отечественного и импортного производства напрямую от производителей и с крупнейших мировых складов;
- Поставка более 17-ти миллионов наименований электронных компонентов;
- Поставка сложных, дефицитных, либо снятых с производства позиций;
- Оперативные сроки поставки под заказ (от 5 рабочих дней);
- Экспресс доставка в любую точку России;
- Техническая поддержка проекта, помощь в подборе аналогов, поставка прототипов;
- Система менеджмента качества сертифицирована по Международному стандарту ISO 9001;
- Лицензия ФСБ на осуществление работ с использованием сведений, составляющих государственную тайну;
- Поставка специализированных компонентов (Xilinx, Altera, Analog Devices, Intersil, Interpoint, Microsemi, Aeroflex, Peregrine, Syfer, Eurofarad, Texas Instrument, Miteq, Cobham, E2V, MA-COM, Hittite, Mini-Circuits, General Dynamics и др.);

Помимо этого, одним из направлений компании «ЭлектроПласт» является направление «Источники питания». Мы предлагаем Вам помощь Конструкторского отдела:

- Подбор оптимального решения, техническое обоснование при выборе компонента;
- Подбор аналогов;
- Консультации по применению компонента;
- Поставка образцов и прототипов;
- Техническая поддержка проекта;
- Защита от снятия компонента с производства.



Как с нами связаться

Телефон: 8 (812) 309 58 32 (многоканальный)

Факс: 8 (812) 320-02-42

Электронная почта: org@eplast1.ru

Адрес: 198099, г. Санкт-Петербург, ул. Калинина, дом 2, корпус 4, литера А.