

## Cemented Leaded Wirewound Resistors



### DESIGN SUPPORT TOOLS

[click logo to get started](#)

**3D**  
Models  
Available

The AC series is the perfect choice for general purpose power applications. The AEC-Q200 qualified AC-AT series is best suited for automotive applications. The robust silicon cement coating can handle challenging ambient and operating conditions. Typical applications include but are not limited to energy meters, power supplies and automotive electronics. For a given application, requirements of ohmic value, rated power, peak voltage, pulse shape, pulse duration, lead bending, and environmental conditions may be submitted to recommend the most suitable product.

Various lead forms are available such as RT (radial taped), WSZ (Z-form), DK (double kink), EK (single kink) with defined mounting pitch.

### FEATURES

- AEC-Q200 qualified AC-AT series
- High power dissipation in small design
- Non-flammable coating conforming to UL 94 V-0
- Excellent pulse load capability
- Non-inductive (NI) version available
- WSZ-form lead bending available for SMD mounting
- Material categorization: for definitions of compliance please see [www.vishay.com/doc?99912](http://www.vishay.com/doc?99912)



**RoHS**  
COMPLIANT  
HALOGEN  
**FREE**  
**GREEN**  
(5-2008)

### APPLICATIONS

- Automotive electronics
- Industrial electronics
- Power supplies
- White goods
- Pre-charged applications

### STANDARD ELECTRICAL SPECIFICATIONS

TYPE	RATED DISSIPATION $P_{40}$	RATED DISSIPATION $P_{70}$	LIMITING VOLTAGE $U_{max}$	RESISTANCE RANGE <sup>(1)</sup> TCR = -10 ppm/K to -80 ppm/K	RESISTANCE RANGE <sup>(1)</sup> TCR = +100 ppm/K to +180 ppm/K	RESISTANCE RANGE <sup>(1)</sup> TCR = $\pm 100$ ppm/K	RESISTANCE TOLERANCE
AC01	1 W	0.9 W	$\sqrt{P \times R}$	0.10 $\Omega$ to 33 $\Omega$	36 $\Omega$ to 2.4 k $\Omega$	-	$\pm 5$ %
AC01-AT	1 W	0.9 W	$\sqrt{P \times R}$	0.39 $\Omega$ to 33 $\Omega$	36 $\Omega$ to 2.4 k $\Omega$	-	$\pm 5$ %
AC03 <sup>(2)</sup>	3 W	2.5 W	$\sqrt{P \times R}$	0.10 $\Omega$ to 390 $\Omega$	430 $\Omega$ to 3.3 k $\Omega$	3.6 k $\Omega$ to 5.1 k $\Omega$	$\pm 5$ %
AC03-AT	3 W	2.5 W	$\sqrt{P \times R}$	0.27 $\Omega$ to 390 $\Omega$	430 $\Omega$ to 3.3 k $\Omega$	-	$\pm 5$ %
AC04	4 W	3.5 W	$\sqrt{P \times R}$	0.10 $\Omega$ to 620 $\Omega$	680 $\Omega$ to 6.8 k $\Omega$	-	$\pm 5$ %
AC04-AT	4 W	3.5 W	$\sqrt{P \times R}$	0.22 $\Omega$ to 620 $\Omega$	680 $\Omega$ to 6.8 k $\Omega$	-	$\pm 5$ %
AC05	5 W	4.7 W	$\sqrt{P \times R}$	0.10 $\Omega$ to 910 $\Omega$	1.0 k $\Omega$ to 10 k $\Omega$	-	$\pm 5$ %
AC05-AT	5 W	4.7 W	$\sqrt{P \times R}$	0.62 $\Omega$ to 910 $\Omega$	1.0 k $\Omega$ to 10 k $\Omega$	-	$\pm 5$ %
AC07	7 W	5.8 W	$\sqrt{P \times R}$	0.10 $\Omega$ to 820 $\Omega$	910 $\Omega$ to 15 k $\Omega$	-	$\pm 5$ %
AC07-AT	7 W	5.8 W	$\sqrt{P \times R}$	1.0 $\Omega$ to 820 $\Omega$	910 $\Omega$ to 15 k $\Omega$	-	$\pm 5$ %
AC10	10 W	8.4 W	$\sqrt{P \times R}$	0.22 $\Omega$ to 560 $\Omega$	620 $\Omega$ to 27 k $\Omega$	-	$\pm 5$ %
AC10-AT	10 W	8.4 W	$\sqrt{P \times R}$	2.0 $\Omega$ to 560 $\Omega$	620 $\Omega$ to 27 k $\Omega$	-	$\pm 5$ %

#### Notes

- The operating temperature range for these resistors is from -55 °C up to 250 °C
- (1) Resistance value to be selected for  $\pm 5$  % from E24
- (2) AC03 WSZ:  $P_{40} = 1.8$  W;  $P_{70} = 1.5$  W



PART NUMBER AND PRODUCT DESCRIPTION																	
Part Number: <b>AC03000001509JAC00</b> <b>AC03AT0001509JAC00</b>																	
A	C	0	3	0	0	0	0	0	1	5	0	9	J	A	C	0	0
A	C	0	3	A	T	0	0	0	1	5	0	9	J	A	C	0	0
MODEL	VARIANT				TCR / MATERIAL	VALUE		TOLERANCE CODE	PACKAGING CODE	SPECIAL							
<b>AC01000</b> = AC01 <b>AC03000</b> = AC03 <b>AC04000</b> = AC04 <b>AC05000</b> = AC05 <b>AC07000</b> = AC07 <b>AC10000</b> = AC10  <b>AC01AT0</b> = AC01-AT <b>AC03AT0</b> = AC03-AT <b>AC04AT0</b> = AC04-AT <b>AC05AT0</b> = AC05-AT <b>AC07AT0</b> = AC07-AT <b>AC10AT0</b> = AC10-AT	<b>0</b> = neutral <b>1</b> = RT <b>2</b> = SWI <b>3</b> = DK SP 20 mm <b>4</b> = DK LP 33 mm <b>5</b> = DK LP 17.8 mm <b>6</b> = NI Non inductive <b>7</b> = DK LP 25.4 mm <b>8</b> = DK SP 25.4 mm <b>9</b> = WSZ 6720 <b>Z</b> = Value overflow <b>A</b> = EK 22.5 mm <b>B</b> = EK 17.8 mm <b>C</b> = EK 25.4 mm <b>D</b> = Cu wire 0.8 mm <b>E</b> = EK 33 mm <b>G</b> = DK SP 33 mm <b>H</b> = EK 20 mm <b>I</b> = DK SP 17.8 mm				<b>0</b> = standard	<b>3 digit value</b> <b>1 digit multiplier</b> <b>MULTIPLIER</b> <b>7</b> = *10 <sup>-3</sup> <b>8</b> = *10 <sup>-2</sup> <b>9</b> = *10 <sup>-1</sup> <b>0</b> = *10 <sup>0</sup> <b>1</b> = *10 <sup>1</sup> <b>2</b> = *10 <sup>2</sup>		<b>J</b> = ± 5.0 %	(see Packaging table)	<b>00</b> = standard <b>2 digit code</b> = customized version <sup>(1)</sup>							
<b>Product Description: AC03 15R 5 % AC</b> <b>AC03AT 15R 5 % AC</b>																	
AC03		15R		5 %		AC											
AC03-AT		15R		5 %		AC											
TYPE		RESISTANCE		TOLERANCE		PACKAGING											
AC01 AC01-AT AC03 AC03-AT AC04 AC04-AT AC05 AC05-AT AC07 AC07-AT AC10 AC10-AT		R10 = 0.1 Ω 75R = 75 Ω 27K = 27 kΩ		5 %		AC LB A1 LC AB LK AE BM											

**Note**

<sup>(1)</sup> For special windings or the non-inductive versions, please contact: [ww1resistors@vishay.com](mailto:ww1resistors@vishay.com)



<b>PACKAGING</b>							
<b>TYPE / SIZE</b>	<b>CODE</b>	<b>DESCRIPTION</b>	<b>QUANTITY</b>	<b>PACKAGING STYLE</b>	<b>WIDTH</b>	<b>PITCH</b>	<b>DIMENSIONS</b>
AC01 AC01-AT	A1	A1	1000	Taped acc. to IEC 60286-1 fan-folded in a box	63 mm	10 mm	260 mm x 85 mm x 70 mm
AC01 DK/EK	LC	LC	500	Bulk packaging	-	-	260 mm x 80 mm x 55 mm
AC01 RT	AE	RE	2500	Taped acc. to IEC 60286-2 fan-folded in a box	-	12.7 mm	200 mm x 46 mm x 334 mm
AC03 AC03-AT	AC	AC	500	Taped acc. to IEC 60286-1 fan-folded in a box	63 mm	10 mm	260 mm x 85 mm x 58 mm
AC03 DK/EK	LC	LC	500	Bulk packaging	-	-	224 mm x 82 mm x 54 mm
AC03 RT	AQ	AQ	1800	Taped acc. to IEC 60286-2 fan-folded in a box	-	12.7 mm	200 mm x 46 mm x 334 mm
AC03 WSZ AC03-AT WSZ	BM	BM	1250	Blister taped acc. to IEC 60286-3 in a box	-	8 mm	350 mm x 350 mm x 55 mm
AC04 <sup>(1)</sup> AC04-AT <sup>(1)</sup>	AC	AC	500	Taped acc. to IEC 60286-1 fan-folded in a box	63 mm	10 mm	260 mm x 85 mm x 70 mm 260 mm x 85 mm x 58 mm
AC04 DK/EK	LC	LC	500	Bulk packaging	-	25.4 mm	224 mm x 82 mm x 54 mm
AC05 AC05-AT	AC	AC	500	Taped acc. to IEC 60286-1 fan-folded in a box	63 mm	5 mm	270 mm x 86 mm x 118 mm
AC05 DK/EK	LC	LC	500	Bulk packaging	-	-	224 mm x 82 mm x 54 mm
AC07 AC07-AT	AC	AC	500	Taped acc. to IEC 60286-1 fan-folded in a box	73 mm	10 mm	26 mm x 90 mm x 118 mm
AC07 DK/EK	LB	LB	250	Bulk packaging	-	-	224 mm x 82 mm x 54 mm
AC10 AC10-AT	AB	AB	250	Taped acc. to IEC 60286-1 fan-folded in a box	88 mm	10 mm	265 mm x 105 mm x 105 mm

**Note**

<sup>(1)</sup> Manufacturing at different production locations may involve use of differently sized box



## DESCRIPTION

Wirewound resistors are best suited for use in high power, high current applications. The silicon cement lacquer coating enables AC series to withstand challenging operating and environmental conditions. The coating is resistant to cleaning solvents specified in IEC 60115-1 <sup>(1)</sup>. Production is strictly controlled and follows an extensive set of instructions established for reproducibility.

The winding is done with a specific material on a specially developed fine ceramic body (Al<sub>2</sub>O<sub>3</sub>). The ceramic meets the highest requirements against mechanical resistance, thermal shocks, dielectric strength, and insulation resistance at high temperatures. With different diameters and turn spacings of resistive wire, a large ohmic value range can be covered.

The resistors are marked with resistance, rated dissipation (P<sub>40</sub>) and tolerance. Product quality is verified by testing procedures, performed on all individual resistors. Resistance is measured on the lead wires at a distance of 6 mm from the resistor body. If a greater length of lead wire is used in the application, the user may need to consider the additional wire resistance, particularly with low resistance products.

## MATERIALS

Vishay acknowledges the following systems for the regulation of hazardous substances:

- IEC 62474, Material Declaration for Products of and for the Electrotechnical Industry, with the list of declarable substances given therein <sup>(2)</sup>
- The Global Automotive Declarable Substance List (GADSL) <sup>(3)</sup>
- The REACH regulation (1907/2006/EC) and the related list of substances with very high concern (SVHC) <sup>(4)</sup> for its supply chain

The products do not contain any of the banned substances as per IEC 62474, GADSL, or the SVHC list, see [www.vishay.com/how/leadfree](http://www.vishay.com/how/leadfree). Hence the products fully comply with the following directives:

- 2000/53/EC End-of-Life Vehicle Directive (ELV) and Annex II (ELV II)
- 2011/65/EU Restriction of the Use of Hazardous Substances Directive (RoHS) with amendment 2015/863/EU
- 2012/19/EU Waste Electrical and Electronic Equipment Directive (WEEE)

Vishay pursues the elimination of conflict minerals from its supply chain, see the Conflict Minerals Policy at [www.vishay.com/doc?49037](http://www.vishay.com/doc?49037).

## Notes

- <sup>(1)</sup> Other cleaning solvents with aggressive chemicals should be evaluated in actual cleaning process for their suitability
- <sup>(2)</sup> The IEC 62474 list of declarable substances is maintained in a dedicated database, which is available at <http://std.iec.ch/iec62474>
- <sup>(3)</sup> The Global Automotive Declarable Substance List (GADSL) is maintained by the American Chemistry Council and available at [www.gadsl.org](http://www.gadsl.org)
- <sup>(4)</sup> The SVHC list is maintained by the European Chemical Agency (ECHA) and available at <http://echa.europa.eu/candidate-list-table>

## ASSEMBLY

The resistors are axial leaded for soldering. The terminals of the resistors are completely lead (Pb)-free, the special tin plating provides compatibility with lead (Pb)-free and lead-containing soldering processes.

Special lead forms may be available on request, please inquire at [ww1resistors@vishay.com](mailto:ww1resistors@vishay.com). These components are high dissipation power resistors, customers are advised to use a high melting point solder.

## APPLICATION INFORMATION

The power dissipation of the resistor generates a temperature rise with respect to the ambient. The permissible dissipation is derated for temperatures above 40 °C, as shown in the derating diagram, in order to avoid overheating of the resistor. The heat dissipated from the resistor may affect adjacent components, hence proper clearance will be required in order to avoid overheating. The resistive wire is encapsulated by a protective lacquer coating.

All materials used are non-flammable and inorganic.

These resistors do not feature a limited lifetime when operated within the permissible limits. However, resistance value drift increasing over operating time may result in exceeding a limit acceptable to the specific application, thereby establishing a functional lifetime.

## APPROVALS

The AC-AT series is AEC-Q200 qualified, specifically for use in automotive applications.

## RELATED PRODUCTS

UL approved, special cement coated fusible resistor is also available. For details please see the datasheet:

“AC01-CS, AC03-CS, AC05-CS - Axial Cemented Fusible Wirewound Safety Resistors” [www.vishay.com/doc?28909](http://www.vishay.com/doc?28909)

For high surge wirewound products, silicon cement coated Z300-Cxx series is available, see the datasheet:

“Z300-Cxx - High Surge Axial Cemented Wirewound Resistors” [www.vishay.com/doc?21027](http://www.vishay.com/doc?21027)

For precision applications, cement coated PAC series is available, see the datasheet:

“PAC Series - Cemented Wirewound Precision Resistors” [www.vishay.com/doc?28731](http://www.vishay.com/doc?28731)



**PULSE DIAGRAMS**

( $t_i$  = pulse duration;  $t_p$  = repetition time)



**AC01 and AC01-AT** Pulse on a regular basis; max. permissible peak pulse power ( $\dot{P}_{max}$ ) as a function of pulse duration ( $t_i$ )



**AC03 and AC03-AT** Pulse on a regular basis; max. permissible peak pulse power ( $\dot{P}_{max}$ ) as a function of pulse duration ( $t_i$ )



**AC04 and AC04-AT** Pulse on a regular basis; max. permissible peak pulse power ( $\dot{P}_{max}$ ) as a function of pulse duration ( $t_i$ )



**AC05 and AC05-AT** Pulse on a regular basis; max. permissible peak pulse power ( $\dot{P}_{max}$ ) as a function of pulse duration ( $t_i$ )



**AC07 and AC07-AT** Pulse on a regular basis; max. permissible peak pulse power ( $\dot{P}_{max}$ ) as a function of pulse duration ( $t_i$ )



**AC10 and AC10-AT** Pulse on a regular basis; max. permissible peak pulse power ( $\dot{P}_{max}$ ) as a function of pulse duration ( $t_i$ )



### PULSE DIAGRAMS

Pulse energy in joules or wattseconds is calculated with the help of the  $R$ -value to be used in the application. Choose the  $R$  value on X axis and look for the corresponding  $E$  (Ws/ $\Omega$ ) value on Y axis. Multiplying both the  $R$  ( $\Omega$ ) to corresponding  $E$  (Ws/ $\Omega$ ), will be resultant total pulse Energy (Ws or J) for adiabatic conditions.

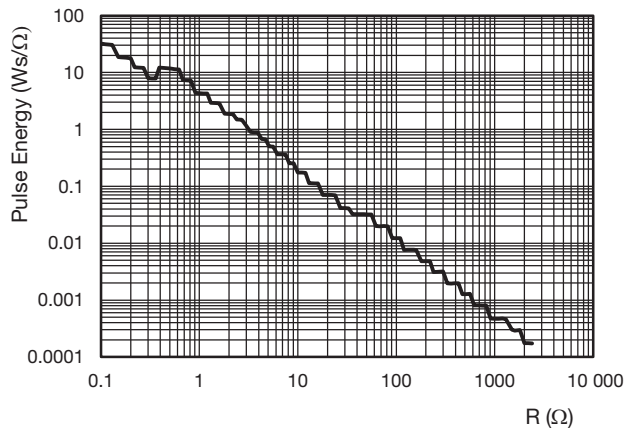

**AC01 and AC01-AT** Pulse capability;  $E$  (Ws) as a function of  $R$  ( $\Omega$ )

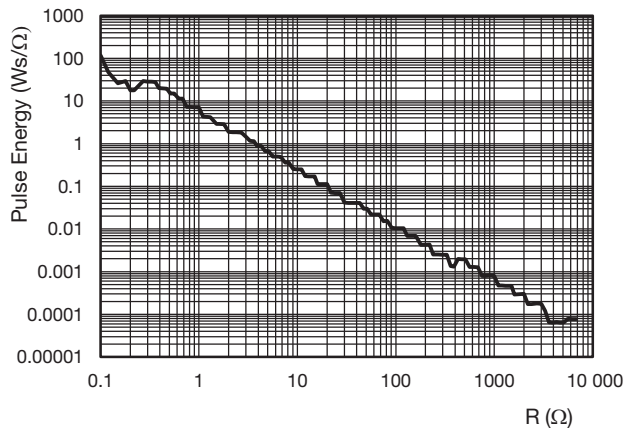

**AC03 and AC03-AT** Pulse capability;  $E$  (Ws) as a function of  $R$  ( $\Omega$ )

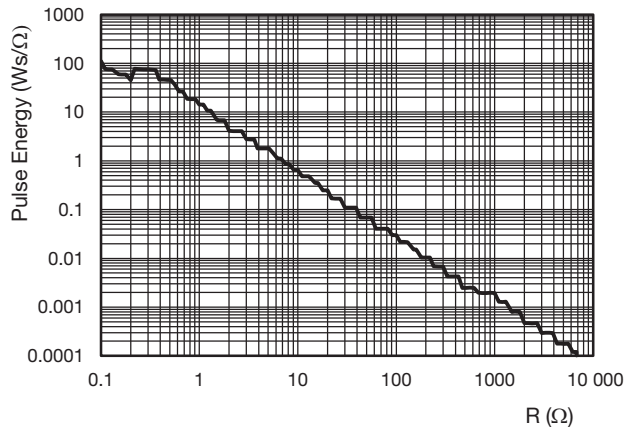

**AC04 and AC04-AT** Pulse capability;  $E$  (Ws) as a function of  $R$  ( $\Omega$ )

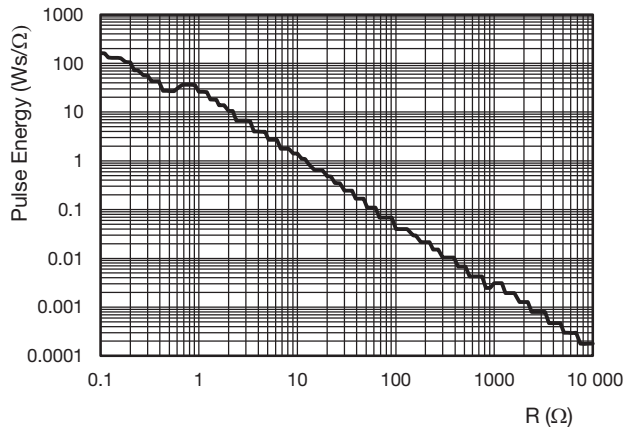

**AC05 and AC05-AT** Pulse capability;  $E$  (Ws) as a function of  $R$  ( $\Omega$ )

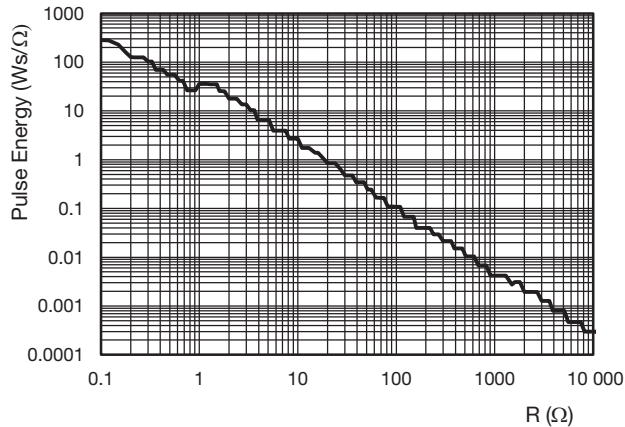

**AC07 and AC07-AT** Pulse capability;  $E$  (Ws) as a function of  $R$  ( $\Omega$ )

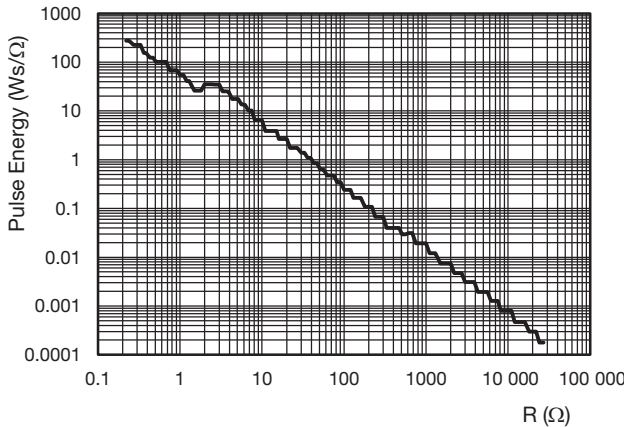

**AC10 and AC10-AT** Pulse capability;  $E$  (Ws) as a function of  $R$  ( $\Omega$ )



**AC01 and AC01-AT** Pulse on a regular basis; max. permissible peak pulse voltage ( $\hat{V}_{max}$ ) as a function of pulse duration ( $t_i$ )



**AC03 and AC03-AT** Pulse on a regular basis; max. permissible peak pulse voltage ( $\hat{V}_{max}$ ) as a function of pulse duration ( $t_i$ )



**AC04 and AC04-AT** Pulse on a regular basis; max. permissible peak pulse voltage ( $\hat{V}_{max}$ ) as a function of pulse duration ( $t_i$ )



**AC05 and AC05-AT** Pulse on a regular basis; max. permissible peak pulse voltage ( $\hat{V}_{max}$ ) as a function of pulse duration ( $t_i$ )



**AC07 and AC07-AT** Pulse on a regular basis; max. permissible peak pulse voltage ( $\hat{V}_{max}$ ) as a function of pulse duration ( $t_i$ )



**AC10 and AC10-AT** Pulse on a regular basis; max. permissible peak pulse voltage ( $\hat{V}_{max}$ ) as a function of pulse duration ( $t_i$ )



**FUNCTIONAL PERFORMANCE**

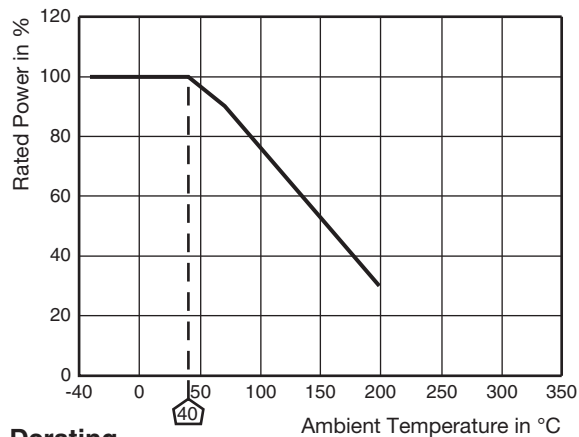

**Derating**



**Temperature Rise**





**TESTS PROCEDURES AND REQUIREMENTS**

All tests are carried out in accordance with the following specifications:

- IEC 60115-1, generic specification (includes tests)

The test and requirements table contains only the most important tests. For the full test schedule refer to the documents above.

The tests are carried out in accordance with IEC 60068-2-xx test method and under standard atmospheric conditions in accordance with IEC 60068-1, 5.3.

Climatic category -40 / 200 / 56 (rated temperature range: lower category temperature, upper category temperature; damp heat, steady state, test duration: 56 days) is valid.

Unless otherwise specified the following values apply:

- Temperature: 15 °C to 35 °C
- Relative humidity: 45 % to 75 %
- Air pressure: 86 kPa to 106 kPa (860 mbar to 1060 mbar)

For performing some of the tests, the components are mounted on a test board in accordance with IEC 60115-1, 4.31.

In test procedures and requirements table, only the tests and requirements are listed with reference to the relevant clauses of IEC 60115-1 and IEC 60068-2-xx test methods. A short description of the test procedure is also given.

TEST PROCEDURES AND REQUIREMENTS				
IEC 60115-1 CLAUSE	IEC 60068-2 TEST METHOD	TEST	PROCEDURE	REQUIREMENTS PERMISSIBLE CHANGE ( $\Delta R_{MAX.}$ )
4.13	-	Short time overload	Room temperature; 10x rated power $P_{40}$ ; 5 s	$\pm (2 \% R + 0.1 \Omega)$
4.16	21 (Ua <sub>1</sub> ) 21 (Ub) 21 (Uc)	Robustness of terminations	Tensile, bending and torsion	No damage $\pm (0.5 \% R + 0.05 \Omega)$
4.18	20 (Tb)	Resistance to soldering heat	Unmounted components (260 $\pm$ 5) °C; (10 $\pm$ 1) s	$\pm (0.5 \% R + 0.05 \Omega)$
4.19	-	Rapid change of temperature	30 min at -55 °C and 30 min at +200 °C; 5 cycles	$\pm (1.5 \% R + 0.05 \Omega)$
4.23		Climatic sequence:		
4.23.2	2 (Ba)	Dry heat	16 h; 200 °C	
4.23.3	30 (Db)	Damp heat (accelerated) 1st cycle	24 h; 55 °C; 90 % to 100 % RH	
4.23.4	1 (Aa)	Cold	2 h; -55 °C	$\pm (1 \% R + 0.05 \Omega)$
4.23.5	13 (M)	Low air pressure	2 h; 8.5 kPa; 15 °C to 35 °C	
4.23.6	30 (Db)	Damp heat remaining cyclic	5 days; 55 °C; 95 % to 100 % RH; 5 cycles	
4.24	78 (Cab)	Damp heat, (steady state)	56 days; (40 $\pm$ 2) °C; (93 $\pm$ 5) % RH	$\pm (5 \% R + 0.1 \Omega)$
4.25.2	-	Endurance (at room temperature)	1000 h; loaded with 116 % of $P_{70}$	$\pm (5 \% R + 0.1 \Omega)$
4.25.3	-	Endurance at upper category temperature	125 °C; without load; 1000 h 200 °C; 30 % of $P_{70}$ ; 1000 h	$\pm (5 \% R + 0.1 \Omega)$ $\pm (5 \% R + 0.1 \Omega)$
4.35	-	Flammability	IEC 60695-11-5 needle flame test; 10 s	No burning after 30 s
4.37	67 C(y)	Damp heat, steady state, accelerated	(85 $\pm$ 2) °C; RH (85 $\pm$ 3) %; 1000 h; 10 % of operation power ( $P_{70}$ ) $U \leq 0.3 \times U_{max.}$	$\pm (5 \% R + 0.1 \Omega)$
4.38	-	Electrostatic discharge test	2 discharges, 8 kV (1 positive, 1 negative)	$\pm (5 \% R + 0.1 \Omega)$

## DIMENSION AND MASS



DIMENSIONS in millimeters						
TYPE	$L_{max.}$	$D_{max.}$	d	$x_{max.}$	B	MASS PER UNIT (g)
AC01, AC01-AT	11.0	4.3	0.8 ± 0.03	2	63 ± 1	0.52
AC03, AC03-AT	13.0	4.8		2	63 ± 1	0.75
AC04, AC04-AT	16.5	5.5		3	63 ± 1	1.10
AC05, AC05-AT	18.0	7.5		3	63 ± 1	1.90
AC07, AC07-AT	26.0	7.5		3	73 ± 1	2.60
AC10, AC10-AT	44.0	8.0		3	88 ± 1	4.50

## LEAD TERMINATION BENDING FORMS



DIMENSIONS - Single and double kink lead type outline												
TYPE	$\varnothing D_{max.}$ (mm)	$L_{max.}$ (mm)	KINK TYPE	TERMINATION WIRE DIAMETER (1) $\varnothing d$ (mm)	$h \pm 1$ (mm)	$P \pm 0.5$ (mm)	$P_1 \pm 0.5$ (mm)	$P_2 \pm 3$ (mm)	$S_{max.}$ (mm)	$\varnothing B \pm 0.1$ (mm)	MASS (g)	PART NUMBER VARIANT
AC01	4.3	11.0	EK	0.8 ± 0.03	8.0	17.8	-	-	2	1.0	0.52	B
			DK SP	0.8 ± 0.03	8.0	-	19.8	17.8	2	1.0	0.52	I
			DK LP	0.8 ± 0.03	8.0	-	17.8	17.8	2	1.0	0.52	5
AC03	4.8	13.0	EK	0.8 ± 0.03	8.0	20.0	-	-	2	1.0	0.75	H
			EK	0.8 ± 0.03	8.0	25.4	-	-	2	1.0	0.75	C
			DK SP	0.8 ± 0.05	8.0	-	22.0	20.0	2	1.0	0.75	3
			DK SP	0.8 ± 0.05	8.0	-	27.4	25.4	2	1.0	0.75	8
			DK LP	0.8 ± 0.05	8.0	-	17.8	17.8	2	1.0	0.75	5
			DK LP	0.8 ± 0.05	8.0	-	25.4	25.4	2	1.0	0.75	7
AC04	5.5	16.5	EK	0.8 ± 0.05	8.0	25.4	-	-	2	1.0	1.10	C
			DK SP	0.8 ± 0.05	8.0	-	22.0	20.0	2	1.0	1.10	3
			DK SP	0.8 ± 0.05	8.0	-	27.4	25.4	2	1.0	1.10	8
			DK LP	0.8 ± 0.05	8.0	-	25.4	25.4	2	1.0	1.10	7
AC05	7.5	18.0	EK	0.8 ± 0.05	8.0	22.5	-	-	2	1.0	1.90	A
			EK	0.8 ± 0.05	8.0	25.4	-	-	2	1.0	1.90	C
			DK SP	0.8 ± 0.05	8.0	-	22.0	20.0	2	1.0	1.90	3
AC07	7.5	26.0	EK	0.8 ± 0.05	8.0	33.0	-	-	2	1.0	2.60	E
			DK SP	0.8 ± 0.05	8.0	-	35.0	33.0	2	1.0	2.60	G
			DK LP	0.8 ± 0.05	8.0	-	33.0	33.0	2	1.0	2.60	4

**Note**

(1) Terminal wire material is FeCu

**Z-FORM LEADS FOR SMD MOUNTING** in millimeters

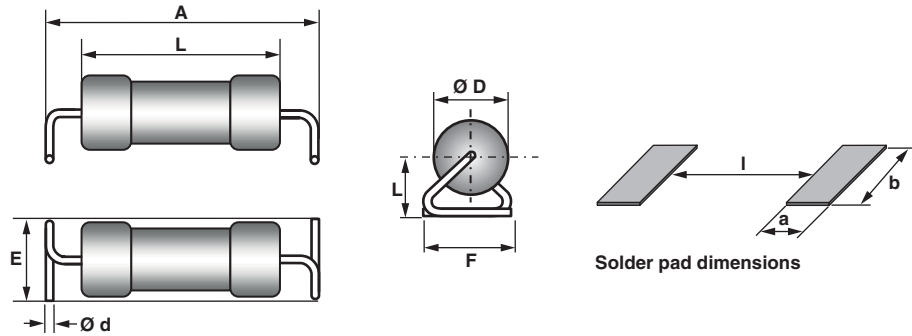
 LEAD BENDING STYLE = WSZ  
 (Z-form)

TYPE WSZ	Ø d	Ø D <sub>max.</sub>	A	L	F	H	E	a	b	l
AC03, AC03-AT	0.8	4.8	17 ± 0.3	11 - 12	4.8 ± 0.2	3.6 ± 0.2	5.0 ± 0.4	2.5	5.5	14.5

**AC01 WITH RADIAL TAPING**

LEAD BENDING STYLE = RT (Radial Taped)

**DIMENSIONS** in millimeters

Pitch of components	P	12.7 ± 1.0
Lead spacing	F	5.0 + 0.6, - 0.1
Width of carrier tape	W	18.0 ± 0.5
Height for cutting (max.)	L <sub>1</sub>	11
Height for insertion (max.)	H <sub>1</sub>	32

**AC03 WITH RADIAL TAPING**

LEAD BENDING STYLE = RT (Radial Taped)

**DIMENSIONS** in millimeters

Pitch of components	P	12.7 ± 1.0
Lead spacing	F	5.0 + 0.4, - 0.2
Width of carrier tape	W	18.0 ± 0.5
Height for cutting (max.)	L <sub>1</sub>	11
Height for insertion (max.)	H <sub>1</sub>	32



## **Disclaimer**

ALL PRODUCT, PRODUCT SPECIFICATIONS AND DATA ARE SUBJECT TO CHANGE WITHOUT NOTICE TO IMPROVE RELIABILITY, FUNCTION OR DESIGN OR OTHERWISE.

Vishay Intertechnology, Inc., its affiliates, agents, and employees, and all persons acting on its or their behalf (collectively, "Vishay"), disclaim any and all liability for any errors, inaccuracies or incompleteness contained in any datasheet or in any other disclosure relating to any product.

Vishay makes no warranty, representation or guarantee regarding the suitability of the products for any particular purpose or the continuing production of any product. To the maximum extent permitted by applicable law, Vishay disclaims (i) any and all liability arising out of the application or use of any product, (ii) any and all liability, including without limitation special, consequential or incidental damages, and (iii) any and all implied warranties, including warranties of fitness for particular purpose, non-infringement and merchantability.

Statements regarding the suitability of products for certain types of applications are based on Vishay's knowledge of typical requirements that are often placed on Vishay products in generic applications. Such statements are not binding statements about the suitability of products for a particular application. It is the customer's responsibility to validate that a particular product with the properties described in the product specification is suitable for use in a particular application. Parameters provided in datasheets and / or specifications may vary in different applications and performance may vary over time. All operating parameters, including typical parameters, must be validated for each customer application by the customer's technical experts. Product specifications do not expand or otherwise modify Vishay's terms and conditions of purchase, including but not limited to the warranty expressed therein.

Except as expressly indicated in writing, Vishay products are not designed for use in medical, life-saving, or life-sustaining applications or for any other application in which the failure of the Vishay product could result in personal injury or death. Customers using or selling Vishay products not expressly indicated for use in such applications do so at their own risk. Please contact authorized Vishay personnel to obtain written terms and conditions regarding products designed for such applications.

No license, express or implied, by estoppel or otherwise, to any intellectual property rights is granted by this document or by any conduct of Vishay. Product names and markings noted herein may be trademarks of their respective owners.



Компания «ЭлектроПласт» предлагает заключение долгосрочных отношений при поставках импортных электронных компонентов на взаимовыгодных условиях!

Наши преимущества:

- Оперативные поставки широкого спектра электронных компонентов отечественного и импортного производства напрямую от производителей и с крупнейших мировых складов;
- Поставка более 17-ти миллионов наименований электронных компонентов;
- Поставка сложных, дефицитных, либо снятых с производства позиций;
- Оперативные сроки поставки под заказ (от 5 рабочих дней);
- Экспресс доставка в любую точку России;
- Техническая поддержка проекта, помощь в подборе аналогов, поставка прототипов;
- Система менеджмента качества сертифицирована по Международному стандарту ISO 9001;
- Лицензия ФСБ на осуществление работ с использованием сведений, составляющих государственную тайну;
- Поставка специализированных компонентов (Xilinx, Altera, Analog Devices, Intersil, Interpoint, Microsemi, Aeroflex, Peregrine, Syfer, Eurofarad, Texas Instrument, Miteq, Cobham, E2V, MA-COM, Hittite, Mini-Circuits, General Dynamics и др.);

Помимо этого, одним из направлений компании «ЭлектроПласт» является направление «Источники питания». Мы предлагаем Вам помощь Конструкторского отдела:

- Подбор оптимального решения, техническое обоснование при выборе компонента;
- Подбор аналогов;
- Консультации по применению компонента;
- Поставка образцов и прототипов;
- Техническая поддержка проекта;
- Защита от снятия компонента с производства.



#### Как с нами связаться

**Телефон:** 8 (812) 309 58 32 (многоканальный)

**Факс:** 8 (812) 320-02-42

**Электронная почта:** [org@eplast1.ru](mailto:org@eplast1.ru)

**Адрес:** 198099, г. Санкт-Петербург, ул. Калинина, дом 2, корпус 4, литера А.