



DP3T - SPDT Coaxial Switches DC to 6 GHz, DC to 20 GHz, DC to 26.5 GHz

Radiall's PLATINUM SERIES switches are optimised to perform at a high level over an extended life span. With outstanding RF performances, and a guaranteed Insertion Loss repeatability of 0.03 dB over a life span of 10 million switching cycles. PLATINUM SERIES switches are perfect for automated test and measurement equipment, as well as signal monitoring devices.

PART NUMBER SELECTION

R 595

RF Connectors :
3 : SMA up to 6 GHz
4 : SMA up to 20 GHz
F : SMA up to 26.5 GHz

Type :
3 : Latching
4 : Latching + Indicators
5 : Latching + Self Cut-Off
6 : Latching + Self Cut-Off + Indicators

Actuator Voltage :
3 : 24 Vdc
7 : 15 Vdc

Documentation :
- : Certificate Of Conformity
C : Calibration certificate
R : Calibration certificate + RF curves

Actuator Terminal :
0 : Solder pins
5 : D-Sub connector

Options :
1 : Without option (Positive common)
2 : Compatible TTL driver (high level)

Switch model :
1 : Non terminated SPDT switch
2 : Terminated SPDT switch
3 : Terminated 4 port bypass switch
4 : Non terminated 5 port DP3T switch

PICTURE

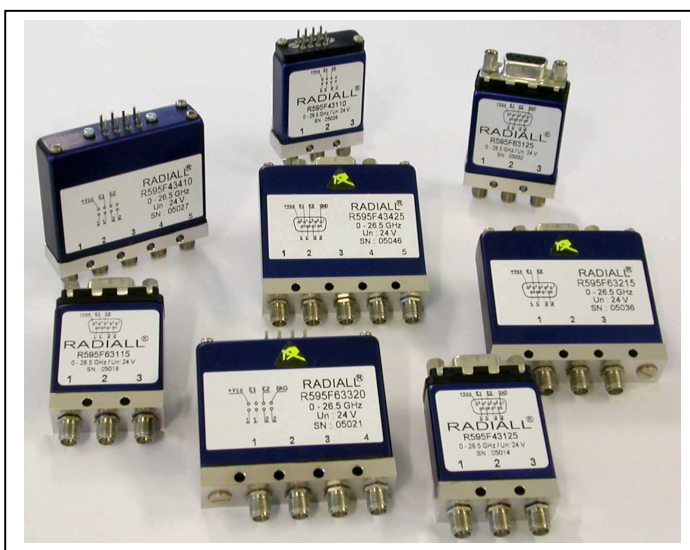

**RF PERFORMANCES**

PART NUMBER	R5953-----	R5954-----	R595F-----
Frequency Range GHz	DC to 6	DC to 20	DC to 26.5
Impedance Ohms	50		
Insertion Loss dB (Maximum)	0.20 + (0.45 / 26.5) x frequency (GHz)		
Isolation dB (Minimum)	85	DC to 6 GHz : 85 6 to 12.4 GHz : 75 12.4 to 20 GHz : 65	DC to 6 GHz : 85 6 to 12.4 GHz : 75 12.4 to 20 GHz : 65 20 to 26.5 GHz : 60
V.S.W.R. (Maximum)	1.15	DC to 6 GHz : 1.15 6 to 12.4 GHz : 1.25 12.4 to 18 GHz : 1.30 18 to 20 GHz : 1.60	DC to 6 GHz : 1.15 6 to 12.4 GHz : 1.25 12.4 to 18 GHz : 1.30 18 to 26.5 GHz : 1.60
Repeatability (Up to 10 million cycles measured at 25°C)	0.03 dB maximum	0.03 dB maximum	0.03 dB maximum

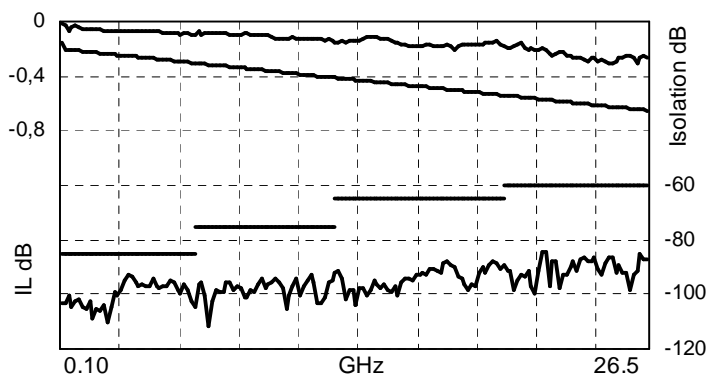
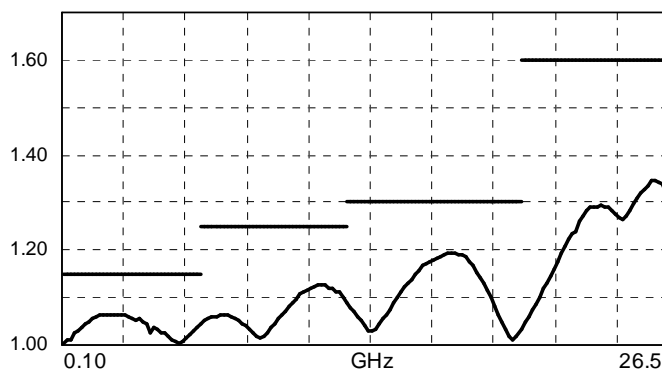
TYPICAL RF PERFORMANCES**Insertion Loss and Isolation****V.S.W.R.**

**ADDITIONAL SPECIFICATIONS**

Operating mode		Latching	
Nominal operating voltage (across operating temperature) Vdc			24 (20 / 32) 15 (12 / 20)
Coil resistance (+/-10%)	Ohms	SPDT	350 120
		Terminated SPDT, DP3T, Bypass	175 60
Nominal operating current at 23°C	mA	SPDT	68 125
		Terminated SPDT, DP3T, Bypass	140 250
Average power		RF path Cold switching : see Power Rating Chart on page 12 Hot switching : 1 Watt CW	
		Internal terminations 1 Watt average into 50 Ω	
TTL input	High Level	3 to 7 V	800 μA max at 7 V
	Low Level	0 to 0.8 V	20 μA max at 0.8V
Switching time (max)	ms	15	
Life (min)		10 million cycles	
Connectors		SMA	
Actuator terminals		D-Sub 9 pin female Solder pins	
Weight (max)	g	SPDT	< 60
		Terminated SPDT, DP3T, Bypass	< 100

ENVIRONMENTAL SPECIFICATIONS

Operating temperature range	°C	-25 to +75
Storage temperature range	°C	-55 to +85
Temperature cycling (MIL-STD-202F , Method 107D , Cond.A)	°C	-55 to +85 (10 cycles)
Sine vibration operating (MIL STD 202 , Method 204D , Cond.D)		10-2000 Hz, 20g
Random vibration operating		16.91g (rms) 50-2000 Hz 3min/axis
Shock operating (MIL STD 202 , Method 213B , Cond.G)		50g / 11 ms, sawtooth
Humidity operating		15 to 95% relative humidity
Humidity storage (MIL STD 202 , Method 106E , Cond.E)		65°C, 95% RH, 10 days
Altitude operating		15,000 feet (4,600 meters)
Altitude storage (MIL STD 202 , Method 105C , Cond.B)		50,000 feet (15,240 meters)





SWITCH MODEL 1 : NON TERMINATED SPDT SWITCH

The non terminated SPDT switch is a single pole double throw switch. This switch is "break before make".

RF SCHEMATIC DIAGRAM

POSITION E1

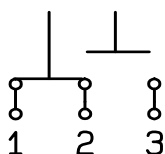

POSITION E2

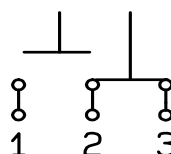

POSITION INDICATORS

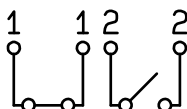

STATE "11"

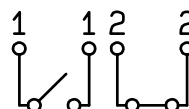

STATE "22"

Standard drive option "1" (Positive common):

- Connect pin +Vcc to supply.
- Select desired RF path by applying ground to the corresponding "close" pin (Ex: ground pin E1 to switch to position E1. RF path 1-2 closed and RF path 2-3 open).
- To open desired path and close the new RF path, connect ground to the corresponding "close" pin (Ex: ground pin E2 to open RF path 1-2 and close RF path 2-3).

TTL drive option "2"

- Connect pin GND to ground.
- Connect pin +Vcc to supply
- Select (close) desired RF path by applying TTL "High" to the corresponding "drive" pin (Ex: apply TTL "High" to pin E1 to switch to position E1. RF path 1-2 closed and RF path 2-3 open).
- To open desired path and close the new RF path, apply TTL "High" to the "drive" pin which corresponds to the desired RF path. (Ex: apply TTL "High" to pin E2 to open RF path 1-2 and close RF path 2-3).

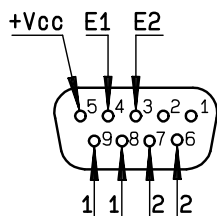

D-Sub connector

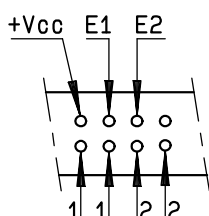

Solder pins

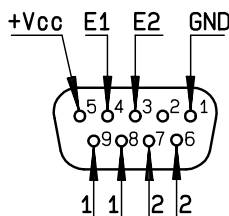

D-Sub connector

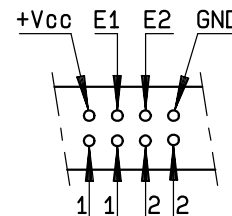

Solder pins





All dimensions are in inches/millimetres.

With D-Sub connector

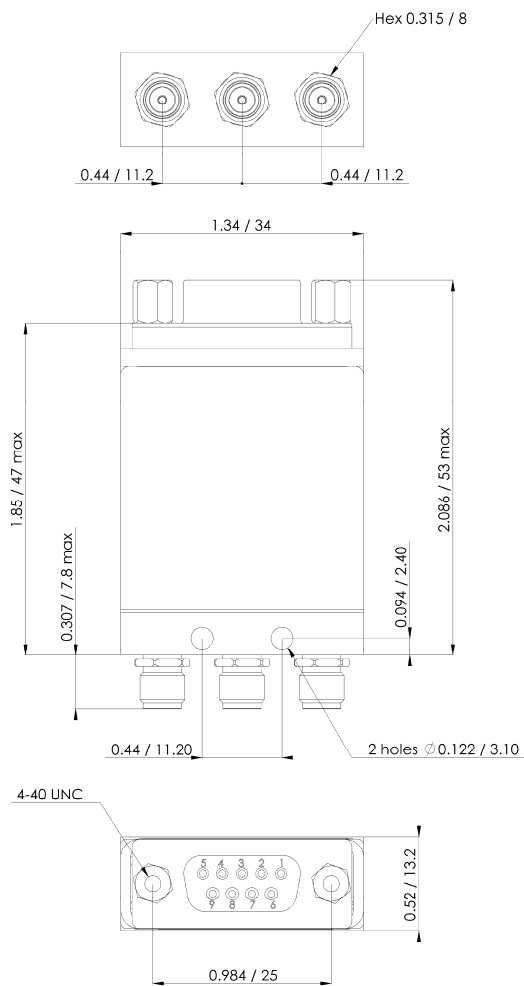

With solder pins

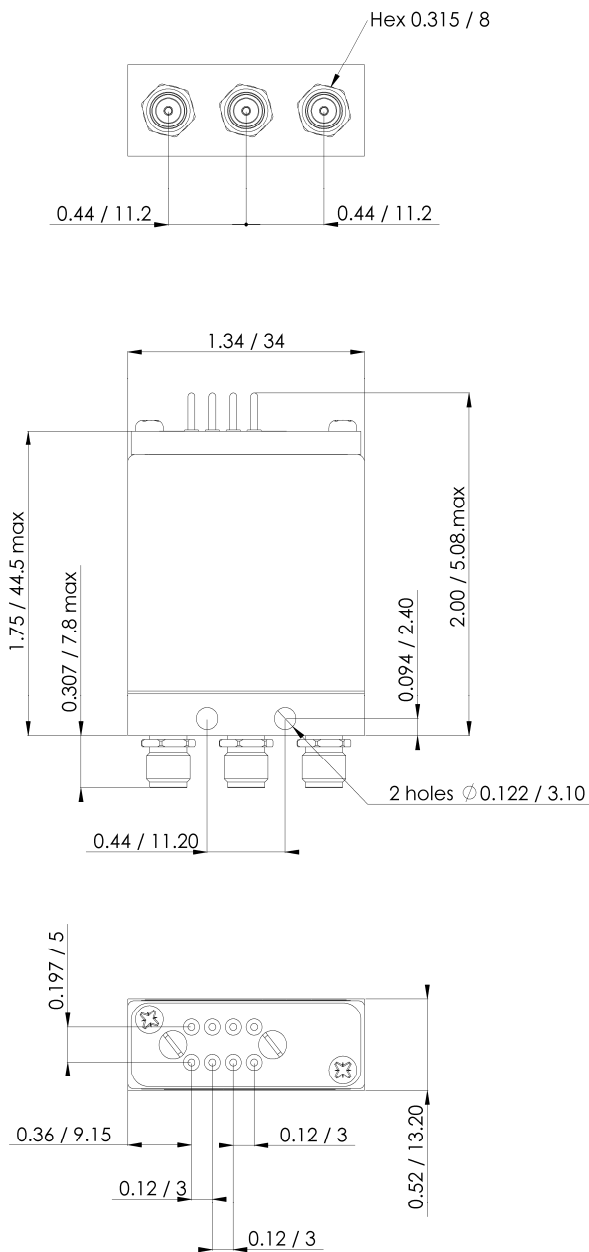



SWITCH MODEL 2 : TERMINATED SPDT SWITCH

The terminated SPDT switch is a single pole double throw switch. The unused ports are terminated into 50 ohms. This switch is "break before make".

RF SCHEMATIC DIAGRAM

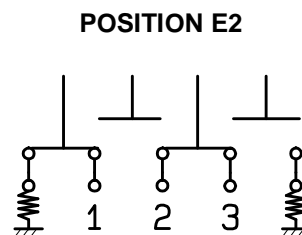
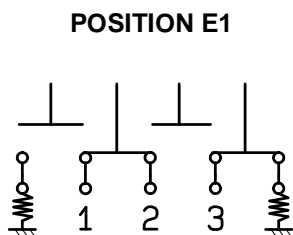

POSITION INDICATORS

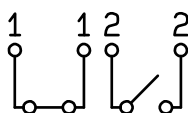

STATE "11"

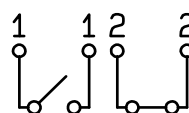

STATE "22"

Standard drive option "1" (Positive common):

- Connect pin +Vcc to supply.
- Select desired RF path by applying ground to the corresponding "close" pin (Ex: ground pin E1 to switch to position E1. RF path 1-2 closed and RF path 2-3 open).
- To open desired path and close the new RF path, connect ground to the corresponding "close" pin (Ex: ground pin E2 to open RF path 1-2 and close RF path 2-3).

TTL drive option "2"

- Connect pin GND to ground.
- Connect pin +Vcc to supply
- Select (close) desired RF path by applying TTL "High" to the corresponding "drive" pin (Ex: apply TTL "High" to pin E1 to switch to position E1. RF path 1-2 closed and RF path 2-3 open).
- To open desired path and close the new RF path, apply TTL "High" to the "drive" pin which corresponds to the desired RF path. (Ex: apply TTL "High" to pin E2 to open RF path 1-2 and close RF path 2-3).

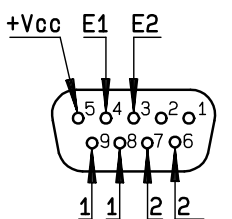

D-Sub connector

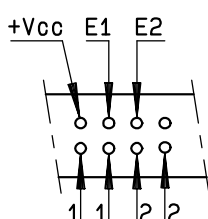

Solder pins

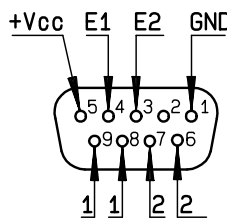

D-Sub connector

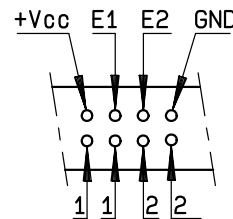

Solder pins



All dimensions are in inches/millimetres.

With D-Sub connector

With solder pins

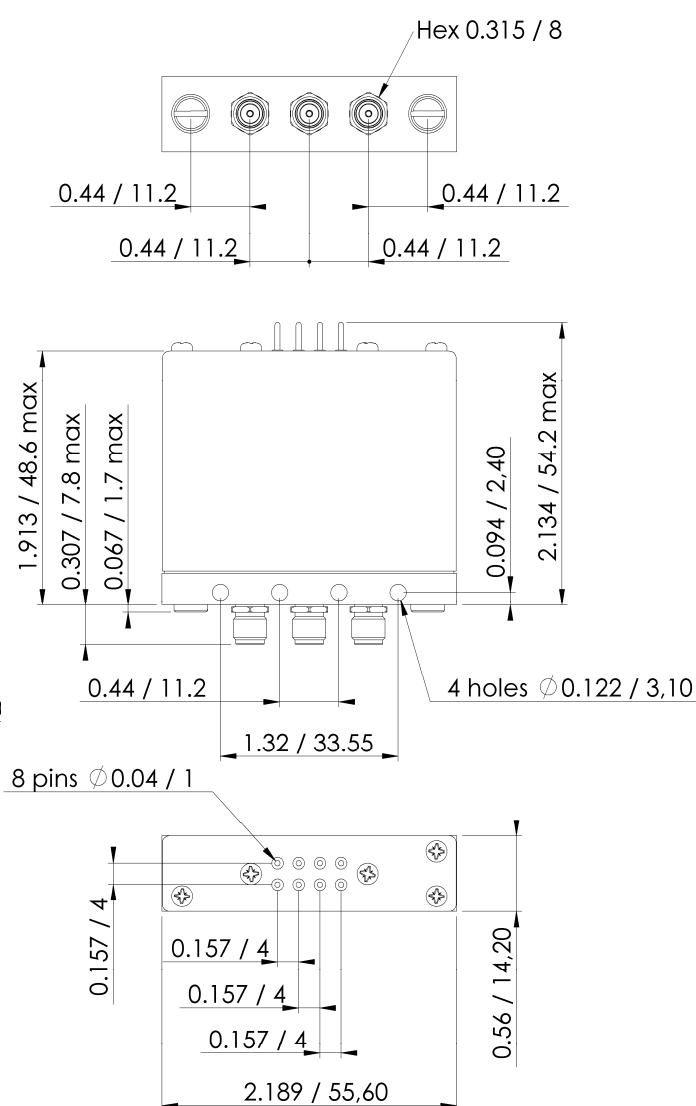
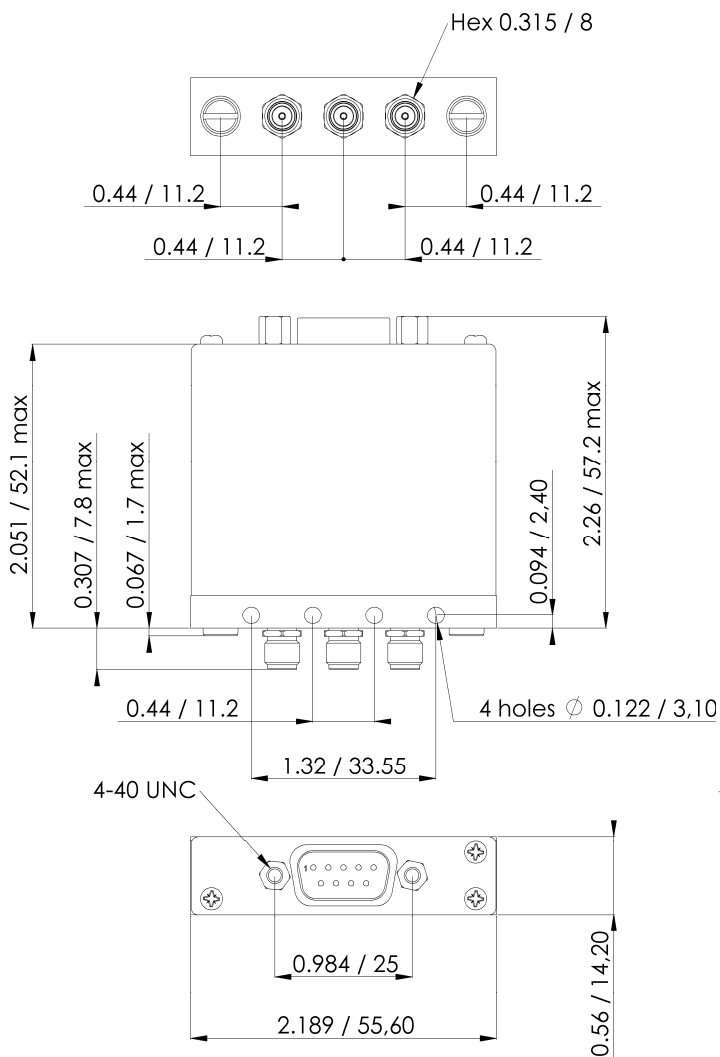



HIGH PERFORMANCE DP3T - SPDT SWITCHES

SWITCH MODEL 3 : TERMINATED 4 PORT BYPASS SWITCH

The terminated 4 port bypass switch can terminate into 50 ohms the device under test. These switches are "break before make".

RF SCHEMATIC DIAGRAM

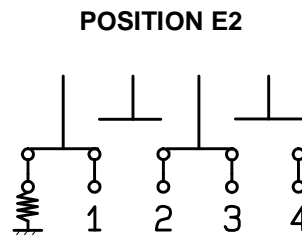
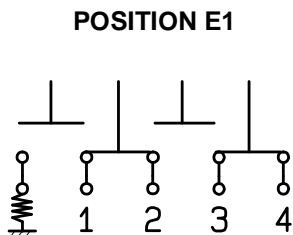

POSITION INDICATORS

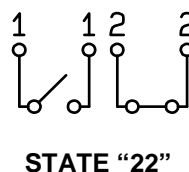
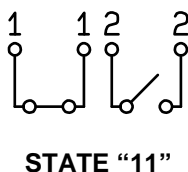

Standard drive option "1" (Positive common):

- Connect pin +Vcc to supply.
- Select desired RF path by applying ground to the corresponding "close" pin (Ex: ground pin E1 to switch to position E1. RF path 1-2 and RF path 3-4 closed and RF path 2-3 open).
- To open desired path and close the new RF path, connect ground to the corresponding "close" pin (Ex: ground pin E2 to open RF path 1-2 and 3-4 and close RF path 2-3).

TTL drive option "2"

- Connect pin GND to ground.
- Connect pin +Vcc to supply.
- Select (close) desired RF path by applying TTL "High" to the corresponding "drive" pin (Ex: apply TTL "High" to pin E1 to switch to position E1. RF path 1-2 and 3-4 closed and RF path 2-3 open).
- To open desired path and close the new RF path, apply TTL "High" to the "drive" pin which corresponds to the desired RF path. (Ex: apply TTL "High" to pin E2 to open RF path 1-2 and 3-4 and close RF path 2-3).

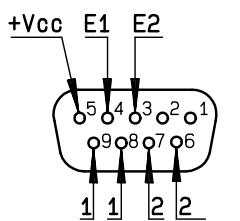

D-Sub connector

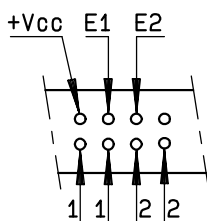

Solder pins

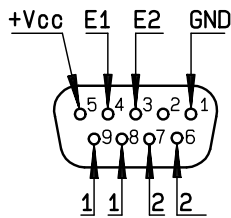

D-Sub connector

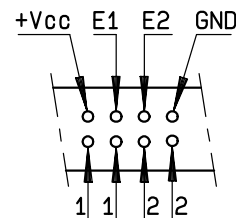

Solder pins





All dimensions are in inches/millimetres.

With D-Sub connector

With solder pins

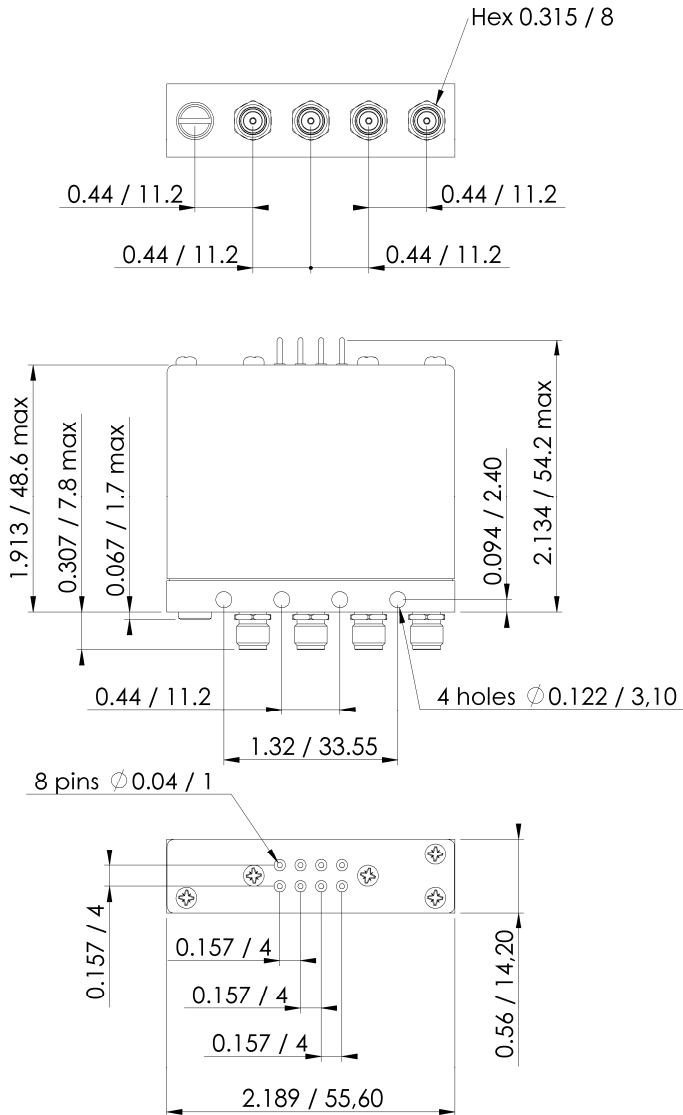
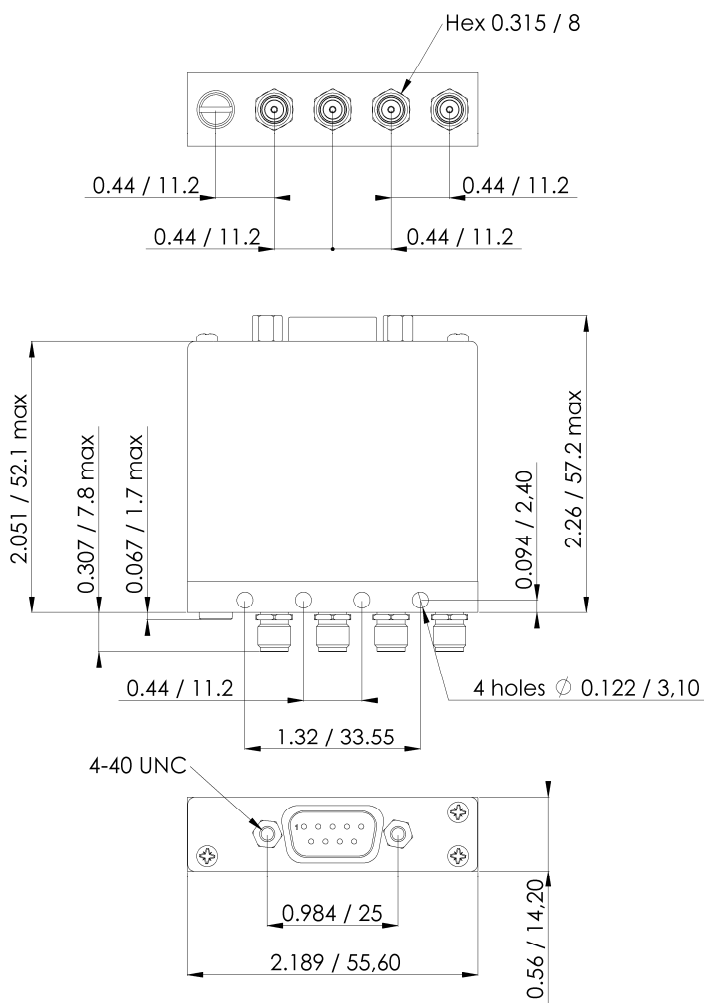



HIGH PERFORMANCE DP3T - SPDT SWITCHES

SWITCH MODEL 4 : NON TERMINATED 5 PORT DP3T SWITCH

The non terminated 5 port DP3T switch can used as SPDT with high power terminations, as a bypass switch. In this application, the fifth port can be terminated externally with a high power termination. These switches are "break before make".

RF SCHEMATIC DIAGRAM

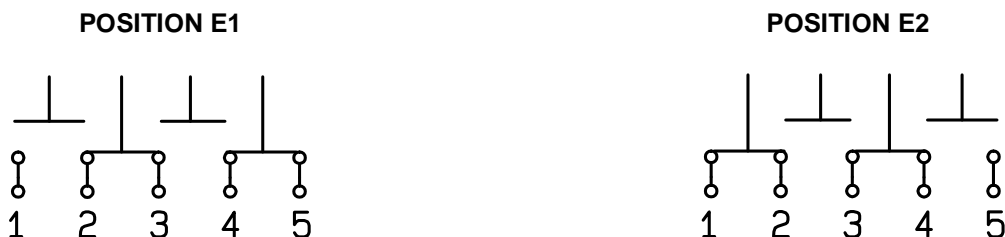

POSITION INDICATORS

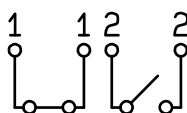

STATE "11"

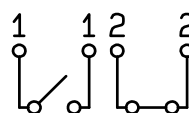

STATE "22"

Standard drive option "1" (Positive common):

- Connect pin +Vcc to supply.
- Select desired RF path by applying ground to the corresponding "close" pin (Ex: ground pin E1 to switch to position E1. RF path 2-3 and RF path 4-5 closed and RF path 1-2 and RF path 3-4 open).
- To open desired path and close the new RF path, connect ground to the corresponding "close" pin (Ex: ground pin E2 to open RF path 2-3 and 4-5 and close RF path 1-2 and 3-4).

TTL drive option "2"

- Connect pin GND to ground.
- Connect pin +Vcc to supply.
- Select (close) desired RF path by applying TTL "High" to the corresponding "drive" pin (Ex: apply TTL "High" to pin E1 to switch to position E1. RF path 2-3 and RF path 4-5 closed and RF path 1-2 and 3-4 open).
- To open desired path and close the new RF path, apply TTL "High" to the "drive" pin which corresponds to the desired RF path. (Ex: apply TTL "High" to pin E2 to open RF path 2-3 and 4-5 and close RF path 1-2 and 3-4).

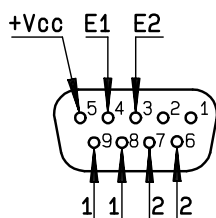

D-Sub connector

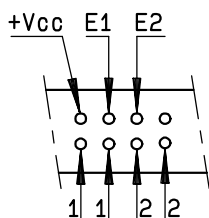

Solder pins

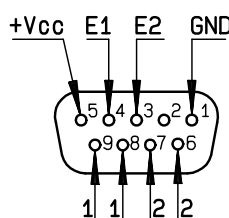

D-Sub connector

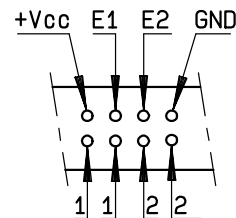

Solder pins





All dimensions are in inches/millimetres.

With D-Sub connector

With solder pins

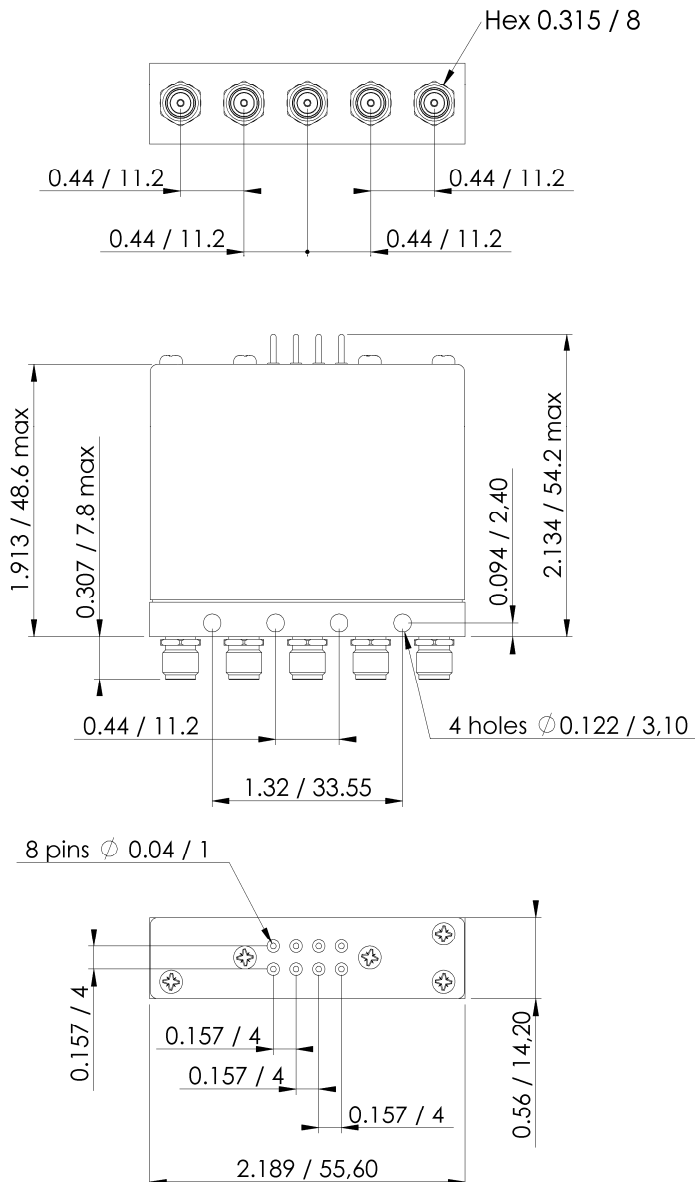
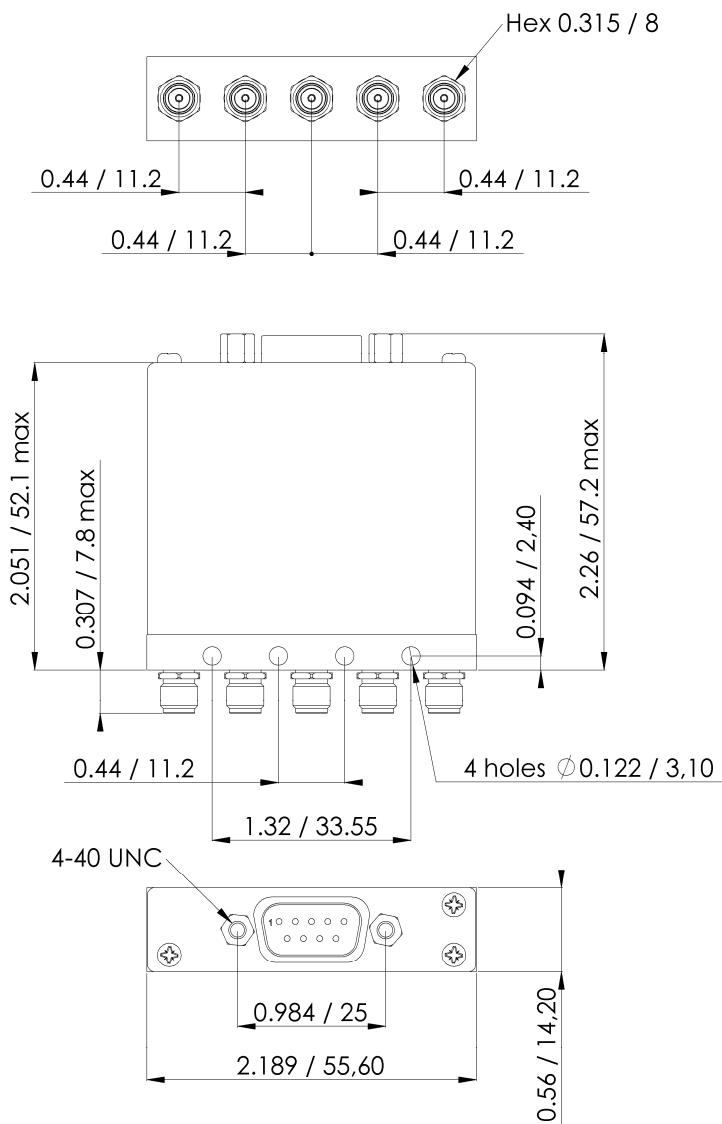



POWER RATING CHART

This graph is based on the following conditions :

- Ambient temperature : + 25°C
- Sea level
- V.S.W.R. : 1 and cold switching

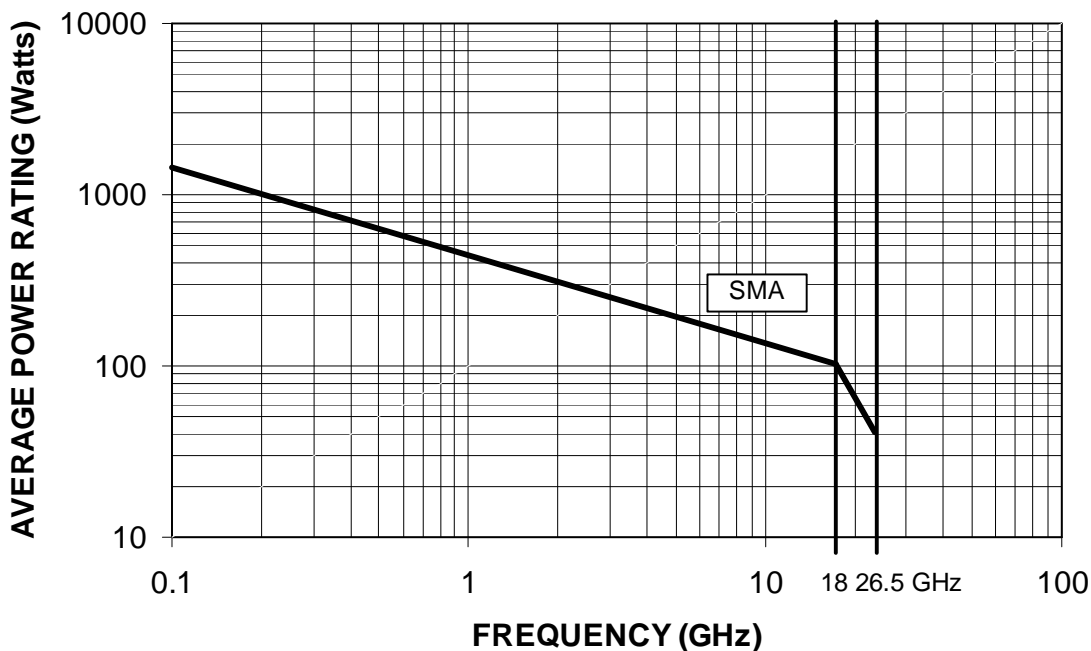

The average power input must be reduced for load V.S.W.R. above 1.

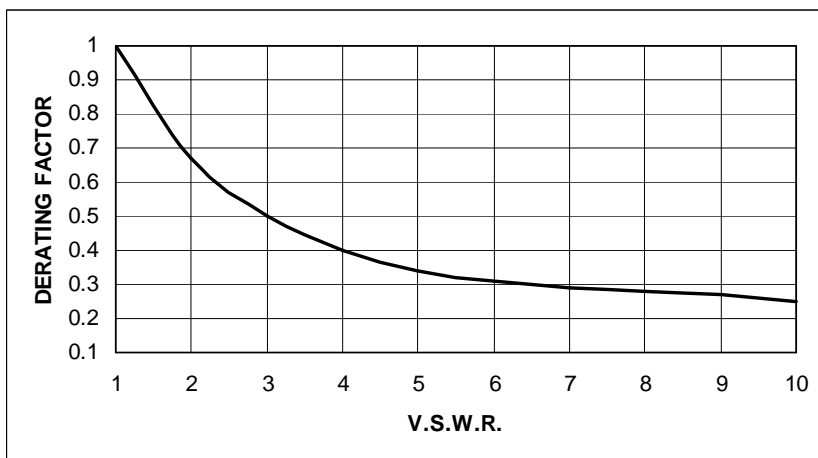



Компания «ЭлектроПласт» предлагает заключение долгосрочных отношений при поставках импортных электронных компонентов на взаимовыгодных условиях!

Наши преимущества:

- Оперативные поставки широкого спектра электронных компонентов отечественного и импортного производства напрямую от производителей и с крупнейших мировых складов;
- Поставка более 17-ти миллионов наименований электронных компонентов;
- Поставка сложных, дефицитных, либо снятых с производства позиций;
- Оперативные сроки поставки под заказ (от 5 рабочих дней);
- Экспресс доставка в любую точку России;
- Техническая поддержка проекта, помощь в подборе аналогов, поставка прототипов;
- Система менеджмента качества сертифицирована по Международному стандарту ISO 9001;
- Лицензия ФСБ на осуществление работ с использованием сведений, составляющих государственную тайну;
- Поставка специализированных компонентов (Xilinx, Altera, Analog Devices, Intersil, Interpoint, Microsemi, Aeroflex, Peregrine, Syfer, Eurofarad, Texas Instrument, Miteq, Cobham, E2V, MA-COM, Hittite, Mini-Circuits, General Dynamics и др.);

Помимо этого, одним из направлений компании «ЭлектроПласт» является направление «Источники питания». Мы предлагаем Вам помощь Конструкторского отдела:

- Подбор оптимального решения, техническое обоснование при выборе компонента;
- Подбор аналогов;
- Консультации по применению компонента;
- Поставка образцов и прототипов;
- Техническая поддержка проекта;
- Защита от снятия компонента с производства.



Как с нами связаться

Телефон: 8 (812) 309 58 32 (многоканальный)

Факс: 8 (812) 320-02-42

Электронная почта: org@eplast1.ru

Адрес: 198099, г. Санкт-Петербург, ул. Калинина, дом 2, корпус 4, литера А.