

## 800 mA Fixed-Output CMOS LDO with Shutdown

### Features

- Very Low Dropout Voltage
- 800 mA Output Current
- High Output Voltage Accuracy
- Standard or Custom Output Voltages
- Overcurrent and Overtemperature Protection

### Applications

- Battery Operated Systems
- Portable Computers
- Medical Instruments
- Instrumentation
- Cellular/GSM/PHS Phones
- Linear Post-Regulators for SMPS
- Pagers

### Typical Application

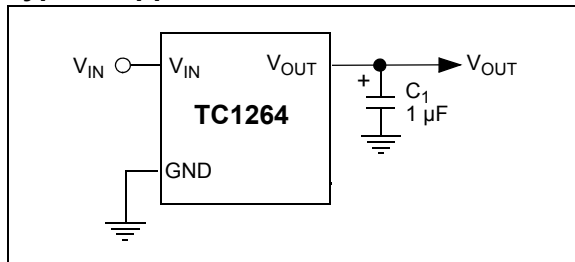

### Description

The TC1264 is a fixed output, high accuracy (typically  $\pm 0.5\%$ ) CMOS low dropout regulator. Designed specifically for battery-operated systems, the TC1264's CMOS construction eliminates wasted ground current, significantly extending battery life. Total supply current is typically  $80\ \mu\text{A}$  at full load (20 to 60 times lower than in bipolar regulators).

TC1264 key features include ultra low noise operation, very low dropout voltage (typically 450 mV at full load), and fast response to step changes in load.

The TC1264 incorporates both over temperature and over current protection. The TC1264 is stable with an output capacitor of only  $1\ \mu\text{F}$  and has a maximum output current of 800 mA. It is available in 3-Pin SOT-223, 3-Pin TO-220 and 3-Pin DDPACK packages.

### Package Type

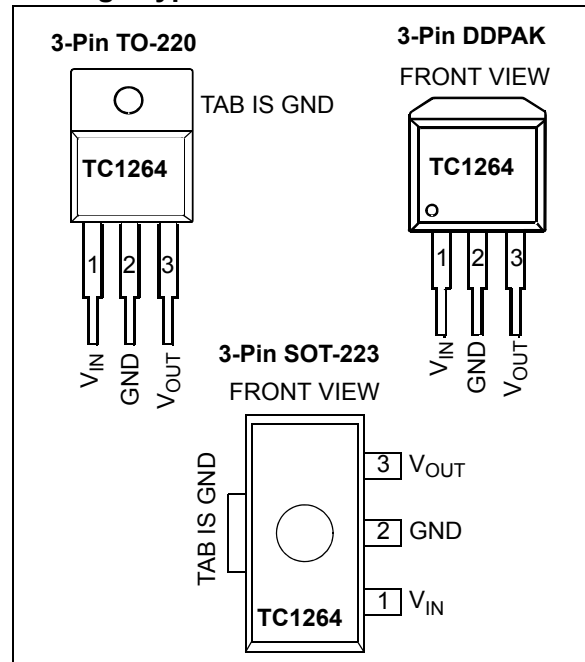

# TC1264

## 1.0 ELECTRICAL CHARACTERISTICS

### Absolute Maximum Ratings †

Input Voltage .....	6.5V
Output Voltage.....	(V <sub>SS</sub> – 0.3V) to (V <sub>IN</sub> + 0.3V)
Power Dissipation.....	Internally Limited ( <b>Note 8</b> )
Maximum Voltage on Any Pin .....	V <sub>IN</sub> +0.3V to -0.3V
Operating Temperature Range.....	-40°C < T <sub>J</sub> < 125°C
Storage Temperature.....	-65°C to +150°C

† **Notice:** Stresses above those listed under "Maximum Ratings" may cause permanent damage to the device. This is a stress rating only and functional operation of the device at those or any other conditions above those indicated in the operation listings of this specification is not implied. Exposure to maximum rating conditions for extended periods may affect device reliability.

### DC CHARACTERISTICS

<b>Electrical Specifications:</b> Unless otherwise indicated, V <sub>IN</sub> = V <sub>R</sub> + 1.5V, ( <b>Note 1</b> ), I <sub>L</sub> = 100 μA, C <sub>L</sub> = 3.3 μF, $\overline{\text{SHDN}} > V_{IH}$ , T <sub>A</sub> = +25°C. <b>Boldface</b> type specifications apply for junction temperatures of -40°C to +125°C.						
Parameters	Sym	Min	Typ	Max	Units	Conditions
Input Operating Voltage	V <sub>IN</sub>	<b>2.7</b>	—	<b>6.0</b>	V	<b>Note 2</b>
Maximum Output Current	I <sub>OUTMAX</sub>	<b>800</b>	—	—	mA	
Output Voltage	V <sub>OUT</sub>	<b>V<sub>R</sub> – 2.5%</b>	V <sub>R</sub> ± 0.5%	<b>V<sub>R</sub> + 2.5%</b>	V	V <sub>R</sub> ≥ 2.5V
		<b>V<sub>R</sub> – 2%</b>	V <sub>R</sub> ± 0.5%	<b>V<sub>R</sub> + 3%</b>		V <sub>R</sub> = 1.8V
		<b>V<sub>R</sub> – 7%</b>	—	<b>V<sub>R</sub> + 3%</b>		I <sub>L</sub> = 0.1 mA to 800 mA <b>(Note 3)</b>
V <sub>OUT</sub> Temperature Coefficient	ΔV <sub>OUT</sub> /ΔT	—	40	—	ppm/°C	<b>Note 4</b>
Line Regulation	ΔV <sub>OUT</sub> /ΔV <sub>IN</sub>	—	0.007	<b>0.35</b>	%	(V <sub>R</sub> + 1V) ≤ V <sub>IN</sub> ≤ 6V
Load Regulation ( <b>Note 5</b> )	ΔV <sub>OUT</sub> /V <sub>OUT</sub>	<b>-0.01</b>	0.002	0	%/mA	I <sub>L</sub> = 0.1 mA to I <sub>OUTMAX</sub>
Dropout Voltage ( <b>Note 6</b> )	V <sub>IN</sub> –V <sub>OUT</sub>	—	20	<b>30</b>	mV	V <sub>R</sub> ≥ 2.5V, I <sub>L</sub> = 100 μA
		—	50	<b>160</b>		I <sub>L</sub> = 100 mA
		—	150	<b>480</b>		I <sub>L</sub> = 300 mA
		—	260	<b>800</b>		I <sub>L</sub> = 500 mA
		—	450	<b>1300</b>		I <sub>L</sub> = 800 mA
		—	1000	<b>1200</b>		V <sub>R</sub> = 1.8V, I <sub>L</sub> = 500 mA
		—	1200	<b>1400</b>		I <sub>L</sub> = 800 mA
Supply Current	I <sub>DD</sub>	—	80	<b>130</b>	μA	$\overline{\text{SHDN}} = V_{IH}$ , I <sub>L</sub> = 0
Power Supply Rejection Ratio	PSRR	—	64	—	db	F ≤ 1 kHz
Output Short Circuit Current	I <sub>OUTSC</sub>	—	1200	—	mA	V <sub>OUT</sub> = 0V

- Note 1:** V<sub>R</sub> is the regulator output voltage setting.
- 2:** The minimum V<sub>IN</sub> has to justify the conditions: V<sub>IN</sub> ≥ V<sub>R</sub> + V<sub>DROPOUT</sub> and V<sub>IN</sub> ≥ 2.7V for I<sub>L</sub> = 0.1 mA to I<sub>OUTMAX</sub>.
- 3:** This accuracy represents the worst-case over the entire output current and temperature range.
- 4:**
- $$TCV_{OUT} = \frac{(V_{OUTMAX} - V_{OUTMIN}) - 10^6}{V_{OUT} \times \Delta T}$$
- 5:** Regulation is measured at a constant junction temperature using low duty cycle pulse testing. Load regulation is tested over a load range from 0.1 mA to the maximum specified output current. Changes in output voltage due to heating effects are covered by the thermal regulation specification.
- 6:** Dropout voltage is defined as the input-to-output differential at which the output voltage drops 2% below its nominal value measured at a 1.5V differential.
- 7:** Thermal regulation is defined as the change in output voltage at a time T after a change in power dissipation is applied, excluding load or line regulation effects. Specifications are for a current pulse equal to I<sub>LMAX</sub> at V<sub>IN</sub> = 6V for T = 10 ms.
- 8:** The maximum allowable power dissipation is a function of ambient temperature, the maximum allowable junction temperature and the thermal resistance from junction-to-air (i.e., T<sub>A</sub>, T<sub>J</sub>, θ<sub>JA</sub>). Exceeding the maximum allowable power dissipation causes the device to initiate thermal shutdown. Please see **Section 5.0 "Thermal Considerations"** for more details..

## DC CHARACTERISTICS (CONTINUED)

<b>Electrical Specifications:</b> Unless otherwise indicated, $V_{IN} = V_R + 1.5V$ , ( <b>Note 1</b> ), $I_L = 100 \mu A$ , $C_L = 3.3 \mu F$ , $\overline{SHDN} > V_{IH}$ , $T_A = +25^\circ C$ . <b>Boldface</b> type specifications apply for junction temperatures of $-40^\circ C$ to $+125^\circ C$ .						
Parameters	Sym	Min	Typ	Max	Units	Conditions
Thermal Regulation	$\Delta V_{OUT}/\Delta P_D$	—	0.04	—	V/W	<b>Note 7</b>
Output Noise	eN	—	260	—	nV/ $\sqrt{Hz}$	$I_L = I_{OUTMAX}$ , F = 10 kHz

**Note 1:**  $V_R$  is the regulator output voltage setting.

**2:** The minimum  $V_{IN}$  has to justify the conditions:  $V_{IN} \geq V_R + V_{DROPOUT}$  and  $V_{IN} \geq 2.7V$  for  $I_L = 0.1 mA$  to  $I_{OUTMAX}$ .

**3:** This accuracy represents the worst-case over the entire output current and temperature range.

**4:**

$$TCV_{OUT} = \frac{(V_{OUTMAX} - V_{OUTMIN}) - 10^6}{V_{OUT} \times \Delta T}$$

**5:** Regulation is measured at a constant junction temperature using low duty cycle pulse testing. Load regulation is tested over a load range from 0.1 mA to the maximum specified output current. Changes in output voltage due to heating effects are covered by the thermal regulation specification.

**6:** Dropout voltage is defined as the input-to-output differential at which the output voltage drops 2% below its nominal value measured at a 1.5V differential.

**7:** Thermal regulation is defined as the change in output voltage at a time T after a change in power dissipation is applied, excluding load or line regulation effects. Specifications are for a current pulse equal to  $I_{LMAX}$  at  $V_{IN} = 6V$  for T = 10 ms.

**8:** The maximum allowable power dissipation is a function of ambient temperature, the maximum allowable junction temperature and the thermal resistance from junction-to-air (i.e.,  $T_A$ ,  $T_J$ ,  $\theta_{JA}$ ). Exceeding the maximum allowable power dissipation causes the device to initiate thermal shutdown. Please see **Section 5.0 "Thermal Considerations"** for more details..

## TEMPERATURE CHARACTERISTICS

<b>Electrical Specifications:</b> Unless otherwise indicated, $V_{IN} = V_R + 1.5V$ , $I_L = 100 \mu A$ , $C_L = 3.3 \mu F$ , $\overline{SHDN} > V_{IH}$ , $T_A = +25^\circ C$ .						
Parameters	Sym	Min	Typ	Max	Units	Conditions
<b>Temperature Ranges</b>						
Specified Temperature Range	$T_A$	-40	—	+125	$^\circ C$	<b>(Note 1)</b>
Operating Temperature Range	$T_J$	-40	—	+125	$^\circ C$	
Storage Temperature Range	$T_A$	-65	—	+150	$^\circ C$	
<b>Thermal Package Resistances</b>						
Thermal Resistance, 3L-SOT-223	$\theta_{JA}$	—	59	—	$^\circ C/W$	
Thermal Resistance, 3L-DDPAK	$\theta_{JA}$	—	71	—	$^\circ C/W$	
Thermal Resistance, 3L-TO-220	$\theta_{JA}$	—	71	—	$^\circ C/W$	

**Note 1:** Operation in this range must not cause  $T_J$  to exceed Maximum Junction Temperature ( $+125^\circ C$ ).

# TC1264

## 2.0 TYPICAL PERFORMANCE CURVES

**Note:** The graphs and tables provided following this note are a statistical summary based on a limited number of samples and are provided for informational purposes only. The performance characteristics listed herein are not tested or guaranteed. In some graphs or tables, the data presented may be outside the specified operating range (e.g., outside specified power supply range) and therefore outside the warranted range.

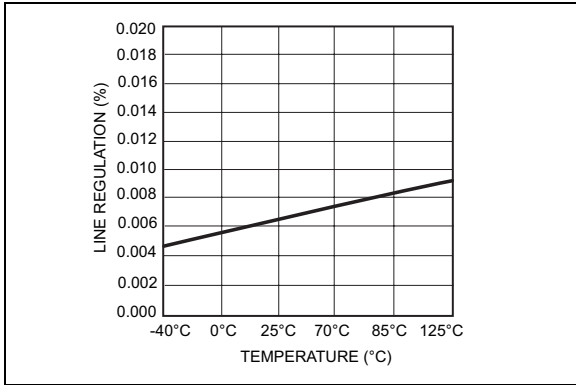

**FIGURE 2-1:** Line Regulation vs. Temperature.

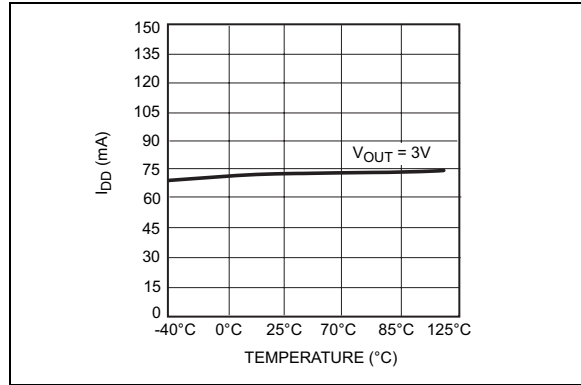

**FIGURE 2-4:**  $I_{DD}$  vs. Temperature.

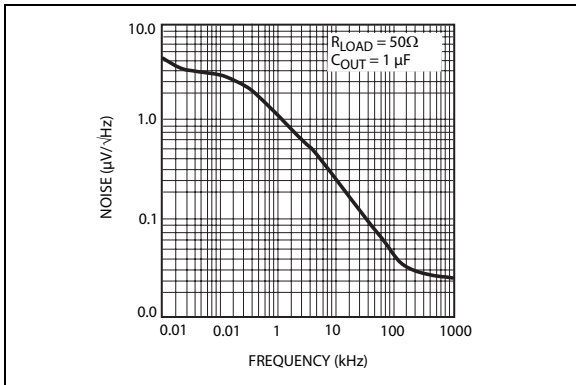

**FIGURE 2-2:** Output Noise vs. Frequency.

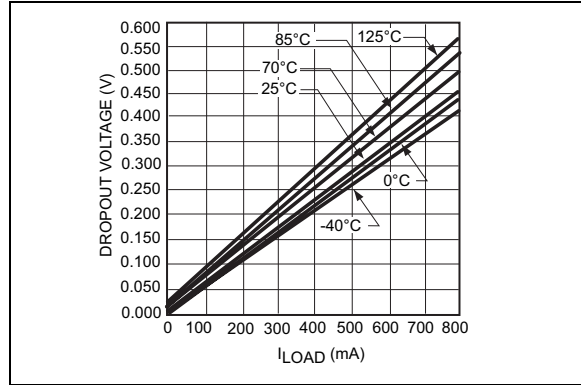

**FIGURE 2-5:** 3.0V Dropout Voltage vs.  $I_{LOAD}$ .

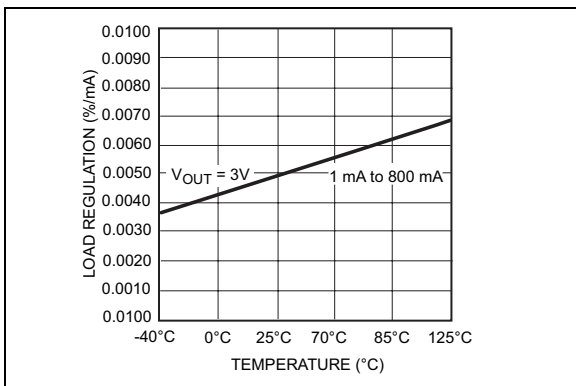

**FIGURE 2-3:** Load Regulation vs. Temperature.

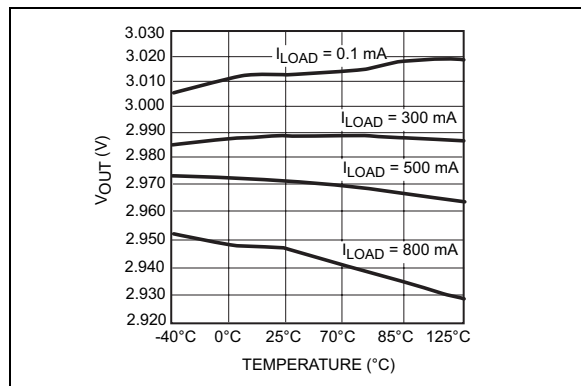

**FIGURE 2-6:** 3.0V  $V_{OUT}$  vs. Temperature.

## 3.0 PIN DESCRIPTIONS

The descriptions of the pins are listed in [Table 3-1](#).

**TABLE 3-1: PIN FUNCTION TABLE**

Pin No. 3-Pin SOT-223 3-Pin TO-220 3-Pin DDPAK	Symbol	Description
1	$V_{IN}$	Unregulated supply input
2	GND	Ground terminal
3	$V_{OUT}$	Regulated voltage output.

### 3.1 Unregulated Supply ( $V_{IN}$ )

Unregulated supply input.

### 3.3 Regulated Output Voltage ( $V_{OUT}$ )

Regulated voltage output.

### 3.2 Ground (GND)

Ground terminal.

# TC1264

## 4.0 DETAILED DESCRIPTION

The TC1264 is a precision, fixed output LDO. Unlike bipolar regulators, the TC1264's supply current does not increase with load current. In addition,  $V_{OUT}$  remains stable and within regulation over the entire 0mA to  $I_{LOADMAX}$  load current range (an important consideration in RTC and CMOS RAM battery back-up applications).

Figure 4-1 shows a typical application circuit.

**FIGURE 4-1: TYPICAL APPLICATION CIRCUIT**

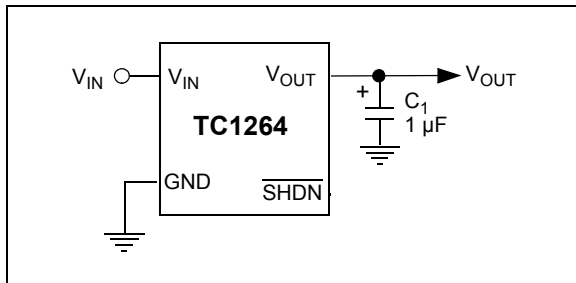

## 4.1 Output Capacitor

A 1  $\mu$ F (min) capacitor from  $V_{OUT}$  to ground is required. The output capacitor should have an effective series resistance greater than 0.1 $\Omega$  and less than 5 $\Omega$ . A 1  $\mu$ F capacitor should be connected from  $V_{IN}$  to GND if there is more than 10 inches of wire between the regulator and the AC filter capacitor, or if a battery is used as the power source. Aluminum electrolytic or tantalum capacitor types can be used. (Since many aluminum electrolytic capacitors freeze at approximately -30°C, solid tantalums are recommended for applications operating below -25°C.) When operating from sources other than batteries, supply-noise rejection and transient response can be improved by increasing the value of the input and output capacitors and employing passive filtering techniques.

## 5.0 THERMAL CONSIDERATIONS

### 5.1 Thermal Shutdown

Integrated thermal protection circuitry shuts the regulator off when die temperature exceeds 160°C. The regulator remains off until the die temperature drops to approximately 150°C.

### 5.2 Power Dissipation

The amount of power the regulator dissipates is primarily a function of input and output voltage, and output current. The following equation is used to calculate worst-case actual power dissipation:

#### EQUATION 5-1:

$$P_D = (V_{INMAX} - V_{OUTMIN})I_{LOADMAX}$$

Where:

- $P_D$  = Worst-case actual power dissipation
- $V_{INMAX}$  = Maximum voltage on  $V_{IN}$
- $V_{OUTMIN}$  = Minimum regulator output voltage
- $I_{LOADMAX}$  = Maximum output (load) current

The maximum allowable power dissipation (Equation 5-2) is a function of the maximum ambient temperature ( $T_{AMAX}$ ), the maximum allowable die temperature ( $T_{JMAX}$ ) and the thermal resistance from junction-to-air ( $\theta_{JA}$ ).

#### EQUATION 5-2:

$$P_{DMAX} = \frac{(T_{JMAX} - T_{AMAX})}{\theta_{JA}}$$

Where all terms are previously defined.

Table 5-1 and Table 5-2 show various values of  $\theta_{JA}$  for the TC1264 packages.

**TABLE 5-1: THERMAL RESISTANCE GUIDELINES FOR TC1264 IN SOT-223 PACKAGE**

Copper Area (Topside)*	Copper Area (Backside)	Board Area	Thermal Resistance ( $\theta_{JA}$ )
2500 sq mm	2500 sq mm	2500 sq mm	45°C/W
1000 sq mm	2500 sq mm	2500 sq mm	45°C/W
225 sq mm	2500 sq mm	2500 sq mm	53°C/W
100 sq mm	2500 sq mm	2500 sq mm	59°C/W
1000 sq mm	1000 sq mm	1000 sq mm	52°C/W
1000 sq mm	0 sq mm	1000 sq mm	55°C/W

\* Tab of device attached to topside copper

**TABLE 5-2: THERMAL RESISTANCE GUIDELINES FOR TC1264 IN 3-PIN DDPACK/TO-220 PACKAGE**

Copper Area (Topside)*	Copper Area (Backside)	Board Area	Thermal Resistance ( $\theta_{JA}$ )
2500 sq mm	2500 sq mm	2500 sq mm	25°C/W
1000 sq mm	2500 sq mm	2500 sq mm	27°C/W
125 sq mm	2500 sq mm	2500 sq mm	35°C/W

\* Tab of device attached to topside copper

Equation 5-1 can be used in conjunction with Equation 5-2 to ensure regulator thermal operation is within limits. For example:

Given:

- $V_{INMAX} = 3.3V \pm 10\%$
- $V_{OUTMIN} = 2.7V \pm 0.5\%$
- $I_{LOADMAX} = 275 \text{ mA}$
- $T_{JMAX} = 125^\circ\text{C}$
- $T_{AMAX} = 95^\circ\text{C}$
- $\theta_{JA} = 59^\circ\text{C/W (SOT-223)}$

Find:

- Actual power dissipation.
- Maximum allowable dissipation

Actual power dissipation:

$$P_D \approx (V_{INMAX} - V_{OUTMIN})I_{LOADMAX}$$

$$P_D = (3.3 \times 1.1) - (2.7 \times .995)275 \times 10^{-3}$$

$$P_D = 260 \text{ mW}$$

Maximum allowable power dissipation:

$$P_{DMAX} = \frac{T_{JMAX} - T_{AMAX}}{\theta_{JA}}$$

$$P_{DMAX} = \frac{(125 - 95)}{59}$$

$$P_{DMAX} = 508 \text{ mW}$$

In this example, the TC1264 dissipates a maximum of 260 mW; below the allowable limit of 508 mW. In a similar manner, Equation 5-1 and Equation 5-2 can be used to calculate maximum current and/or input voltage limits. For example, the maximum allowable  $V_{IN}$ , is found by substituting the maximum allowable power dissipation of 508mW into Equation 5-1, from which  $V_{INMAX} = 4.6V$ .

# TC1264

## 6.0 PACKAGING INFORMATION

### 6.1 Package Marking Information

3-Lead DPAK

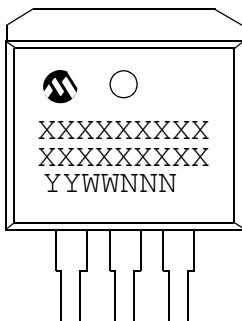

Example

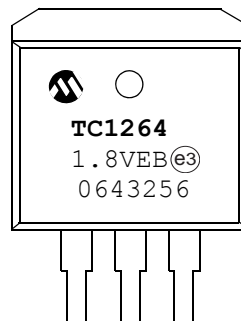

3-Lead SOT-223

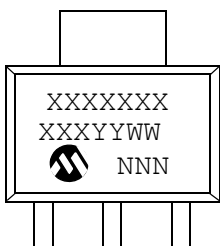

Example

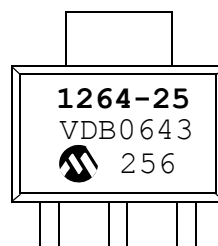

3-Lead TO-220

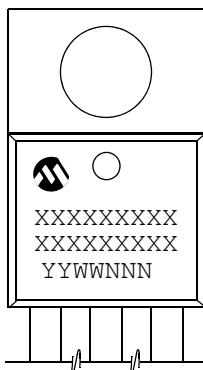

Example

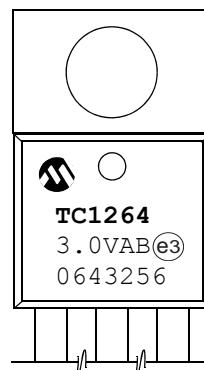

<b>Legend:</b>	XX...X	Customer-specific information
	Y	Year code (last digit of calendar year)
	YY	Year code (last 2 digits of calendar year)
	WW	Week code (week of January 1 is week '01')
	NNN	Alphanumeric traceability code
	(e3)	Pb-free JEDEC designator for Matte Tin (Sn)
	*	This package is Pb-free. The Pb-free JEDEC designator (e3) can be found on the outer packaging for this package.

**Note:** In the event the full Microchip part number cannot be marked on one line, it will be carried over to the next line, thus limiting the number of available characters for customer-specific information.



## 3-Lead Plastic (EB) (DDPAK)

**Note:** For the most current package drawings, please see the Microchip Packaging Specification located at <http://www.microchip.com/packaging>

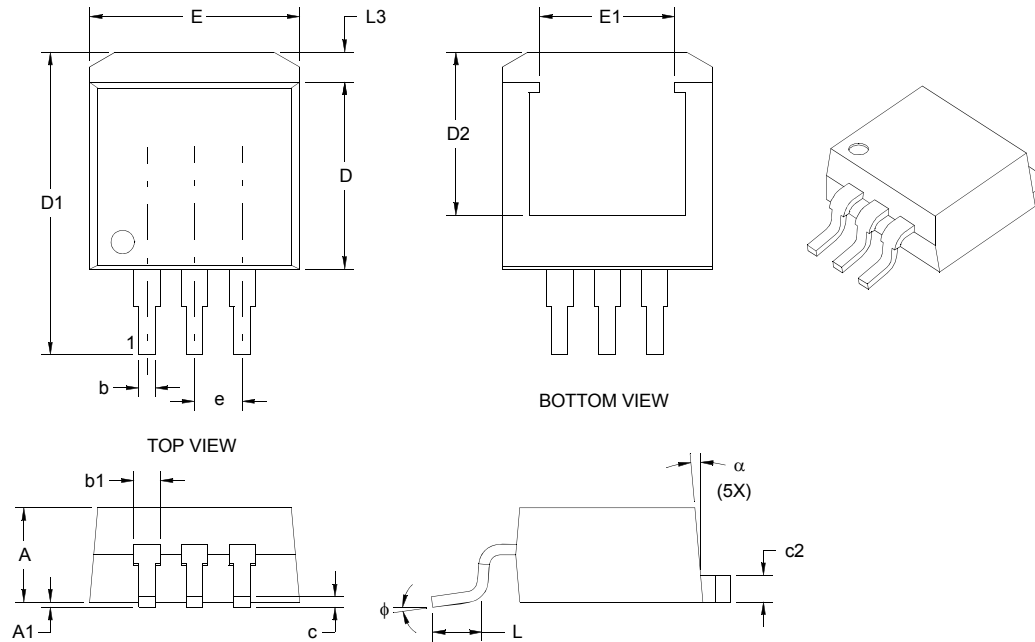

Dimension Limits	Units	INCHES*			MILLIMETERS		
		MIN	NOM	MAX	MIN	NOM	MAX
Number of Pins			3			3	
Pitch	e	1.00 BSC			2.54 BSC		
Overall Height	A	.170	.177	.183	4.32	4.50	4.65
Standoff §	A1	.000	.005	.010	0.00	0.13	0.25
Overall Width	E	.385	.398	.410	9.78	10.11	10.41
Exposed Pad Width	E1	.256 REF			6.50 REF		
Molded Package Length	D	.330	.350	.370	8.38	8.89	9.40
Overall Length	D1	.549	.577	.605	13.94	14.66	15.37
Exposed Pad Length	D2	.303 REF			7.70 REF		
Lead Thickness	c	.014	.020	.026	0.36	0.51	0.66
Pad Thickness	c2	.045	--	.055	1.14	--	1.40
Lower Lead Width	b	.026	.032	.037	0.66	0.81	0.94
Upper Lead Width	b1	.049	.050	.051	1.24	1.27	1.30
Foot Length	L	.068	--	.110	1.73	--	2.79
Pad Length	L3	.045	--	.067	1.14	--	1.70
Foot Angle	φ	--	--	8°	--	--	8°
Mold Draft Angle	α	3°	--	7°	3°	--	7°

\* Controlling Parameter

§ Significant Characteristic

**Notes:**

Dimensions D and E do not include mold flash or protrusions. Mold flash or protrusions shall not exceed .010" (0.254mm) per side.

BSC: Basic Dimension. Theoretically, exact value shown without tolerances.

See ASME Y14.5M

REF: Reference Dimension, usually without tolerance, for information purposes only.

See ASME Y14.5M

JEDEC equivalent: TO-252

Drawing No. C04-011

Revised 07-19-05

# TC1264

## 3-Lead Plastic Small Outline Transistor (DB) (SOT-223)

**Note:** For the most current package drawings, please see the Microchip Packaging Specification located at <http://www.microchip.com/packaging>

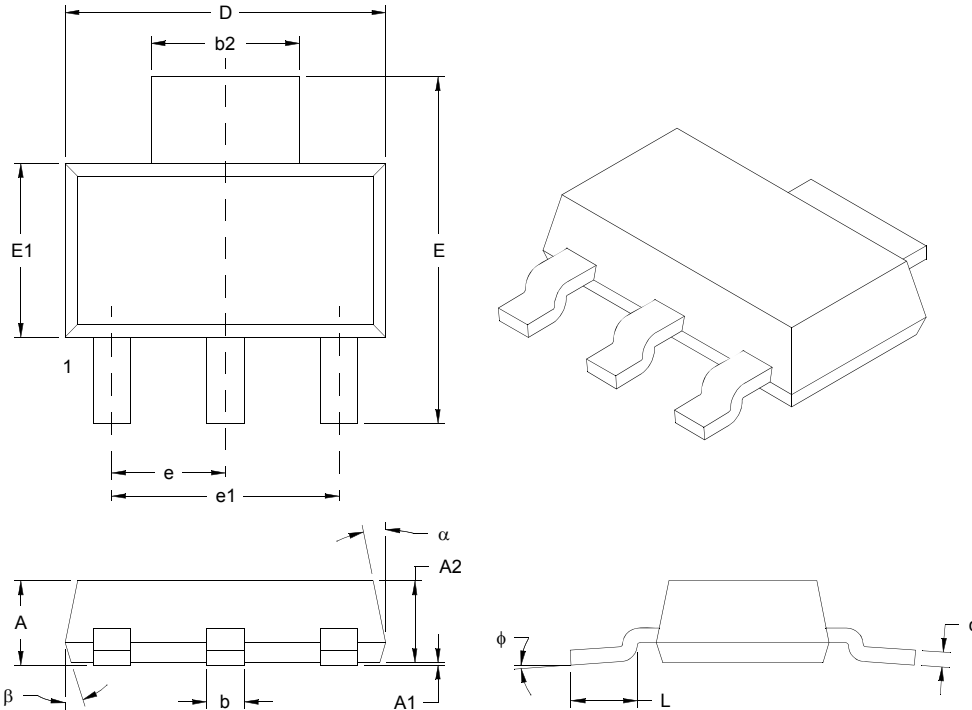

Dimension Limits	Units	INCHES			MILLIMETERS*		
		MIN	NOM	MAX	MIN	NOM	MAX
Pitch	e	.091 BSC			2.30 BSC		
Outside lead pitch (basic)	e1	.181 BSC			4.60 BSC		
Overall Height	A	–	–	.071	–	–	1.80
Standoff	A1	.001	–	.004	0.02	–	0.10
Molded Package Height	A2	.061	.063	.065	1.55	1.60	1.65
Overall Width	E	.264	.276	.287	6.70	7.00	7.30
Molded Package Width	E1	.130	.138	.146	3.30	3.50	3.70
Overall Length	D	.248	.256	.264	6.30	6.50	6.70
Lead Thickness	c	.009	.012	.014	0.23	0.30	0.35
Lead Width	b	.026	.030	.033	0.65	0.76	0.85
Tab Lead Width	b2	.114	.118	.124	2.90	3.00	3.15
Foot Length	L	.035	–	–	0.90	–	–
Lead Angle	φ	0°	–	10°	–	0.37	10°
Mold Draft Angle, Top	α	10°	–	16°	10°	–	16°
Mold Draft Angle, Bottom	β	10°	–	16°	10°	–	16°

\* Controlling Parameter

**Notes:**

Dimensions D and E1 do not include mold flash or protrusions. Mold flash or protrusions shall not exceed .005" (0.127mm) per side.

BSC: Basic Dimension. Theoretically exact value shown without tolerances.

See ASME Y14.5M

JEDEC Equivalent TO-261 AA

Drawing No. C04-032

Revised 09-13-05

## 3-Lead Plastic Transistor Outline (AB) (TO-220)

**Note:** For the most current package drawings, please see the Microchip Packaging Specification located at <http://www.microchip.com/packaging>

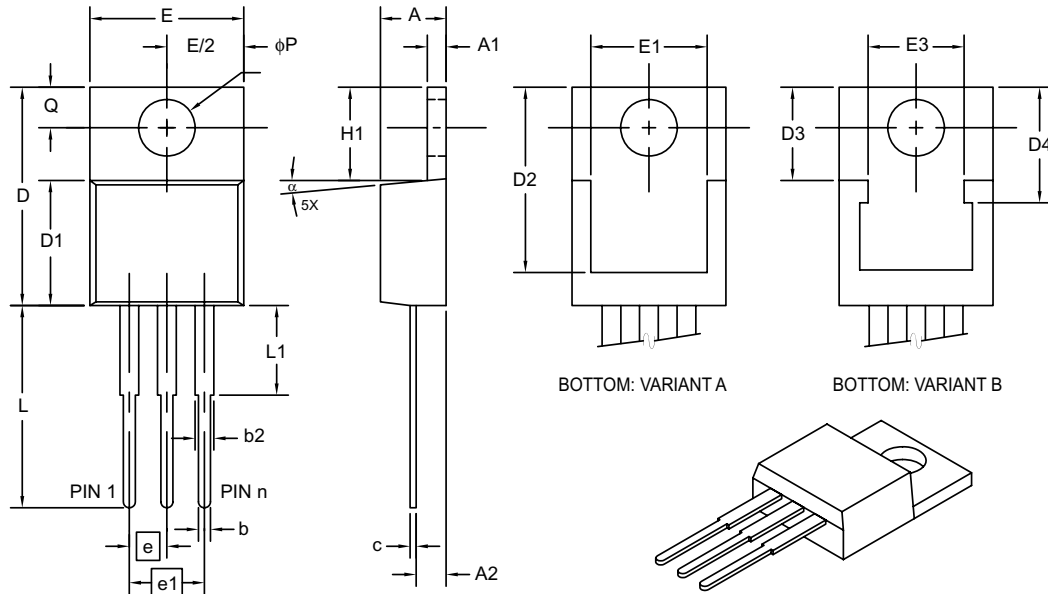

Dimension Limits	Units	INCHES*			MILLIMETERS		
		MIN	NOM	MAX	MIN	NOM	MAX
Number of Pins	n		3			3	
Pitch	e	.100 BSC			2.54 BSC		
Overall Pin Pitch	e1	.200 BSC			5.08 BSC		
Overall Height	A	.140	-	.190	3.56	-	4.83
Tab Thickness	A1	.020	-	.055	0.51	-	1.40
Base to Lead	A2	.080	-	.120	2.03	-	3.05
Overall Width	E	.380	-	.420	9.65	-	10.67
Exposed Tab Width	E1	.270	-	.350	6.86	-	8.89
– (SEE BOTTOM VARIANT B)	E3	.251	.256	.261	6.38	6.50	6.63
Hole Center to Tab Edge	Q	.100	-	.120	2.54	-	3.05
Overall Length	D	.560	-	.650	14.22	-	16.51
Molded Package Length	D1	.330	-	.361	8.38	-	9.17
Exposed Tab Length	D2	.480	-	.507	12.19	-	12.88
– (SEE BOTTOM VARIANT B)	D3	.243	.248	.253	6.17	6.30	6.43
– (SEE BOTTOM VARIANT B)	D4	.303	.308	.313	7.70	7.82	7.95
Tab Length	H1	.230	-	.270	5.84	-	6.86
Mounting Hole Diameter	φP	.139	-	.156	3.53	-	3.96
Lead Length	L	.500	-	.580	12.70	-	14.73
Lead Shoulder	L1	-	-	.250	2.10	-	6.35
Foot Angle	α	0	-	8°	0	-	8°
Lead Thickness	c	.012	-	.024	0.30	-	0.61
Lead Width	b	.015	.027	.040	0.38	0.69	1.02
Shoulder Width	b2	.045	.057	.070	1.14	1.45	1.78

\*Controlling Parameter

**Notes:**

Dimensions D1 and E do not include mold flash or protrusions. Mold flash or protrusions shall not exceed .010" (0.254mm) per side.

BSC: Basic Dimension. Theoretically exact value shown without tolerances.

See ASME Y14.5M

Drawing No. C04-158

# TC1264

---

NOTES:

## APPENDIX A: REVISION HISTORY

### Revision C (October 2006)

- **Section 1.0 “Electrical Characteristics”:**  
Changed dropout voltage typical value for  $I_L = 500$  mA from 700 to 1000 and maximum value from 1000 to 1200 for. Changed typical value for  $I_L = 800$  mA from 890 to 1200
- **Section 6.0 “PackAging Information”:** Added package marking information and package outline drawings
- Added disclaimer to package outline drawings.

### Revision B (May 2002)

- Not Documented

### Revision A (March 2002)

- Original Release of this Document.

# TC1264

---

NOTES:

## PRODUCT IDENTIFICATION SYSTEM

To order or obtain information, e.g., on pricing or delivery, refer to the factory or the listed sales office.

<u>PART NO.</u>	<u>X.XX</u>	<u>XX</u>	<u>XX</u>	<b>Examples:</b>
Device	Voltage Option	Package	Tape and Reel	
Device	TC1264	Fixed Output CMOS LDO		a) TC1264-1.8VAB 1.8V LDO, TO-220-3 pkg. b) TC1264-2.5VAB 2.5V LDO, TO-220-3 pkg. c) TC1264-3.0VAB 3.0V LDO, TO-220-3 pkg. d) TC1264-3.3VAB 3.3V LDO, TO-220-3 pkg.
Voltage Option:*	1.8V = 1.8V 2.5V = 2.5V 3.0V = 3.0V 3.3V = 3.3V			a) TC1264-1.8VEBTR 1.8V LDO, DDPAK-3 pkg., Tape and Reel b) TC1264-2.5VEBTR 2.5V LDO, DDPAK-3 pkg., Tape and Reel c) TC1264-3.0VEBTR 3.0V LDO, DDPAK-3 pkg., Tape and Reel d) TC1264-3.3VEBTR 3.3V LDO, DDPAK-3 pkg., Tape and Reel
	* Other output voltages are available. Please contact your local Microchip sales office for details.			
Package	AB = Plastic (TO-220), 3-Lead DB = Plastic (SOT-223), 3-lead DBTR = Plastic (SOT-223), 3-lead, Tape and Reel EB = Plastic Transistor Outline (DDPAK), 3-Lead EBTR = Plastic Transistor Outline (DDPAK), 3-Lead, Tape and Reel			a) TC1264-1.8VDB 1.8V LDO, SOT-223 pkg. b) TC1264-1.8VDBTR 1.8V LDO, SOT-223 pkg., Tape and Reel c) TC1264-2.5VDB 2.5V LDO, SOT-223 pkg. d) TC1264-2.5VDBTR 2.5V LDO, SOT-223 pkg., Tape and Reel e) TC1264-3.0VDB 3.0V LDO, SOT-223 pkg. f) TC1264-3.0VDBTR 3.0V LDO, SOT-223 pkg., Tape and Reel g) TC1264-3.3VDB 3.3V LDO, SOT-223 pkg. h) TC1264-3.3VDBTR 3.3V LDO, SOT-223 pkg., Tape and Reel

# TC1264

---

NOTES:



---

**Note the following details of the code protection feature on Microchip devices:**

- Microchip products meet the specification contained in their particular Microchip Data Sheet.
- Microchip believes that its family of products is one of the most secure families of its kind on the market today, when used in the intended manner and under normal conditions.
- There are dishonest and possibly illegal methods used to breach the code protection feature. All of these methods, to our knowledge, require using the Microchip products in a manner outside the operating specifications contained in Microchip's Data Sheets. Most likely, the person doing so is engaged in theft of intellectual property.
- Microchip is willing to work with the customer who is concerned about the integrity of their code.
- Neither Microchip nor any other semiconductor manufacturer can guarantee the security of their code. Code protection does not mean that we are guaranteeing the product as “unbreakable.”

Code protection is constantly evolving. We at Microchip are committed to continuously improving the code protection features of our products. Attempts to break Microchip's code protection feature may be a violation of the Digital Millennium Copyright Act. If such acts allow unauthorized access to your software or other copyrighted work, you may have a right to sue for relief under that Act.

---

Information contained in this publication regarding device applications and the like is provided only for your convenience and may be superseded by updates. It is your responsibility to ensure that your application meets with your specifications. MICROCHIP MAKES NO REPRESENTATIONS OR WARRANTIES OF ANY KIND WHETHER EXPRESS OR IMPLIED, WRITTEN OR ORAL, STATUTORY OR OTHERWISE, RELATED TO THE INFORMATION, INCLUDING BUT NOT LIMITED TO ITS CONDITION, QUALITY, PERFORMANCE, MERCHANTABILITY OR FITNESS FOR PURPOSE. Microchip disclaims all liability arising from this information and its use. Use of Microchip devices in life support and/or safety applications is entirely at the buyer's risk, and the buyer agrees to defend, indemnify and hold harmless Microchip from any and all damages, claims, suits, or expenses resulting from such use. No licenses are conveyed, implicitly or otherwise, under any Microchip intellectual property rights.

**Trademarks**

The Microchip name and logo, the Microchip logo, Accuron, dsPIC, KEELOQ, microID, MPLAB, PIC, PICmicro, PICSTART, PRO MATE, PowerSmart, rfPIC, and SmartShunt are registered trademarks of Microchip Technology Incorporated in the U.S.A. and other countries.

AmpLab, FilterLab, Migratable Memory, MXDEV, MXLAB, SEEVAL, SmartSensor and The Embedded Control Solutions Company are registered trademarks of Microchip Technology Incorporated in the U.S.A.

Analog-for-the-Digital Age, Application Maestro, CodeGuard, dsPICDEM, dsPICDEM.net, dsPICworks, ECAN, ECONOMONITOR, FanSense, FlexROM, fuzzyLAB, In-Circuit Serial Programming, ICSP, ICEPIC, Linear Active Thermistor, Mindi, MiWi, MPASM, MPLIB, MPLINK, PICkit, PICDEM, PICDEM.net, PICLAB, PICtail, PowerCal, PowerInfo, PowerMate, PowerTool, REAL ICE, rFLAB, rfPICDEM, Select Mode, Smart Serial, SmartTel, Total Endurance, UNI/O, WiperLock and ZENA are trademarks of Microchip Technology Incorporated in the U.S.A. and other countries.

SQTP is a service mark of Microchip Technology Incorporated in the U.S.A.

All other trademarks mentioned herein are property of their respective companies.

© 2006, Microchip Technology Incorporated, Printed in the U.S.A., All Rights Reserved.

 Printed on recycled paper.

**QUALITY MANAGEMENT SYSTEM**  
**CERTIFIED BY DNV**  
**== ISO/TS 16949:2002 ==**

*Microchip received ISO/TS-16949:2002 certification for its worldwide headquarters, design and wafer fabrication facilities in Chandler and Tempe, Arizona, Gresham, Oregon and Mountain View, California. The Company's quality system processes and procedures are for its PIC® 8-bit MCUs, KEELOQ® code hopping devices, Serial EEPROMs, microperipherals, nonvolatile memory and analog products. In addition, Microchip's quality system for the design and manufacture of development systems is ISO 9001:2000 certified.*



**MICROCHIP**

## WORLDWIDE SALES AND SERVICE

### AMERICAS

**Corporate Office**  
2355 West Chandler Blvd.  
Chandler, AZ 85224-6199  
Tel: 480-792-7200  
Fax: 480-792-7277  
Technical Support:  
<http://support.microchip.com>  
Web Address:  
[www.microchip.com](http://www.microchip.com)

**Atlanta**  
Alpharetta, GA  
Tel: 770-640-0034  
Fax: 770-640-0307

**Boston**  
Westborough, MA  
Tel: 774-760-0087  
Fax: 774-760-0088

**Chicago**  
Itasca, IL  
Tel: 630-285-0071  
Fax: 630-285-0075

**Dallas**  
Addison, TX  
Tel: 972-818-7423  
Fax: 972-818-2924

**Detroit**  
Farmington Hills, MI  
Tel: 248-538-2250  
Fax: 248-538-2260

**Kokomo**  
Kokomo, IN  
Tel: 765-864-8360  
Fax: 765-864-8387

**Los Angeles**  
Mission Viejo, CA  
Tel: 949-462-9523  
Fax: 949-462-9608

**Santa Clara**  
Santa Clara, CA  
Tel: 408-961-6444  
Fax: 408-961-6445

**Toronto**  
Mississauga, Ontario,  
Canada  
Tel: 905-673-0699  
Fax: 905-673-6509

### ASIA/PACIFIC

**Asia Pacific Office**  
Suites 3707-14, 37th Floor  
Tower 6, The Gateway  
Harbour City, Kowloon  
Hong Kong  
Tel: 852-2401-1200  
Fax: 852-2401-3431

**Australia - Sydney**  
Tel: 61-2-9868-6733  
Fax: 61-2-9868-6755

**China - Beijing**  
Tel: 86-10-8528-2100  
Fax: 86-10-8528-2104

**China - Chengdu**  
Tel: 86-28-8665-5511  
Fax: 86-28-8665-7889

**China - Fuzhou**  
Tel: 86-591-8750-3506  
Fax: 86-591-8750-3521

**China - Hong Kong SAR**  
Tel: 852-2401-1200  
Fax: 852-2401-3431

**China - Qingdao**  
Tel: 86-532-8502-7355  
Fax: 86-532-8502-7205

**China - Shanghai**  
Tel: 86-21-5407-5533  
Fax: 86-21-5407-5066

**China - Shenyang**  
Tel: 86-24-2334-2829  
Fax: 86-24-2334-2393

**China - Shenzhen**  
Tel: 86-755-8203-2660  
Fax: 86-755-8203-1760

**China - Shunde**  
Tel: 86-757-2839-5507  
Fax: 86-757-2839-5571

**China - Wuhan**  
Tel: 86-27-5980-5300  
Fax: 86-27-5980-5118

**China - Xian**  
Tel: 86-29-8833-7250  
Fax: 86-29-8833-7256

### ASIA/PACIFIC

**India - Bangalore**  
Tel: 91-80-4182-8400  
Fax: 91-80-4182-8422

**India - New Delhi**  
Tel: 91-11-4160-8631  
Fax: 91-11-4160-8632

**India - Pune**  
Tel: 91-20-2566-1512  
Fax: 91-20-2566-1513

**Japan - Yokohama**  
Tel: 81-45-471- 6166  
Fax: 81-45-471-6122

**Korea - Gumi**  
Tel: 82-54-473-4301  
Fax: 82-54-473-4302

**Korea - Seoul**  
Tel: 82-2-554-7200  
Fax: 82-2-558-5932 or  
82-2-558-5934

**Malaysia - Penang**  
Tel: 60-4-646-8870  
Fax: 60-4-646-5086

**Philippines - Manila**  
Tel: 63-2-634-9065  
Fax: 63-2-634-9069

**Singapore**  
Tel: 65-6334-8870  
Fax: 65-6334-8850

**Taiwan - Hsin Chu**  
Tel: 886-3-572-9526  
Fax: 886-3-572-6459

**Taiwan - Kaohsiung**  
Tel: 886-7-536-4818  
Fax: 886-7-536-4803

**Taiwan - Taipei**  
Tel: 886-2-2500-6610  
Fax: 886-2-2508-0102

**Thailand - Bangkok**  
Tel: 66-2-694-1351  
Fax: 66-2-694-1350

### EUROPE

**Austria - Wels**  
Tel: 43-7242-2244-39  
Fax: 43-7242-2244-393

**Denmark - Copenhagen**  
Tel: 45-4450-2828  
Fax: 45-4485-2829

**France - Paris**  
Tel: 33-1-69-53-63-20  
Fax: 33-1-69-30-90-79

**Germany - Munich**  
Tel: 49-89-627-144-0  
Fax: 49-89-627-144-44

**Italy - Milan**  
Tel: 39-0331-742611  
Fax: 39-0331-466781

**Netherlands - Drunen**  
Tel: 31-416-690399  
Fax: 31-416-690340

**Spain - Madrid**  
Tel: 34-91-708-08-90  
Fax: 34-91-708-08-91

**UK - Wokingham**  
Tel: 44-118-921-5869  
Fax: 44-118-921-5820

10/19/06



Компания «ЭлектроПласт» предлагает заключение долгосрочных отношений при поставках импортных электронных компонентов на взаимовыгодных условиях!

Наши преимущества:

- Оперативные поставки широкого спектра электронных компонентов отечественного и импортного производства напрямую от производителей и с крупнейших мировых складов;
- Поставка более 17-ти миллионов наименований электронных компонентов;
- Поставка сложных, дефицитных, либо снятых с производства позиций;
- Оперативные сроки поставки под заказ (от 5 рабочих дней);
- Экспресс доставка в любую точку России;
- Техническая поддержка проекта, помощь в подборе аналогов, поставка прототипов;
- Система менеджмента качества сертифицирована по Международному стандарту ISO 9001;
- Лицензия ФСБ на осуществление работ с использованием сведений, составляющих государственную тайну;
- Поставка специализированных компонентов (Xilinx, Altera, Analog Devices, Intersil, Interpoint, Microsemi, Aeroflex, Peregrine, Syfer, Eurofarad, Texas Instrument, Miteq, Cobham, E2V, MA-COM, Hittite, Mini-Circuits, General Dynamics и др.);

Помимо этого, одним из направлений компании «ЭлектроПласт» является направление «Источники питания». Мы предлагаем Вам помощь Конструкторского отдела:

- Подбор оптимального решения, техническое обоснование при выборе компонента;
- Подбор аналогов;
- Консультации по применению компонента;
- Поставка образцов и прототипов;
- Техническая поддержка проекта;
- Защита от снятия компонента с производства.



#### Как с нами связаться

**Телефон:** 8 (812) 309 58 32 (многоканальный)

**Факс:** 8 (812) 320-02-42

**Электронная почта:** [org@eplast1.ru](mailto:org@eplast1.ru)

**Адрес:** 198099, г. Санкт-Петербург, ул. Калинина, дом 2, корпус 4, литера А.