

4.7 mm×3.5 mm SMD Light Touch Switches

Type: **EVQP2/EVQP9/EVQ3P2**

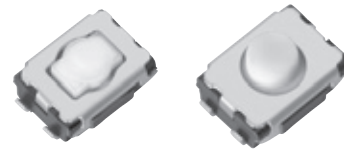

■ Features

- External dimensions : 4.7 mm×3.5 mm,
Height : Middle Push Travel 2.5 mm
Short Push Travel 2.1 mm, 2.5 mm
- High operating force and long operational life
- High mountability with J-bent (4 terminals)

■ Recommended Applications

- Operation switches for portable electronic equipment (Mobile phones, Digital still cameras, Camcorders, Portable audio players, etc.)
- Keyless entry systems (automotive)
- Car audio equipment

■ Explanation of Part Numbers

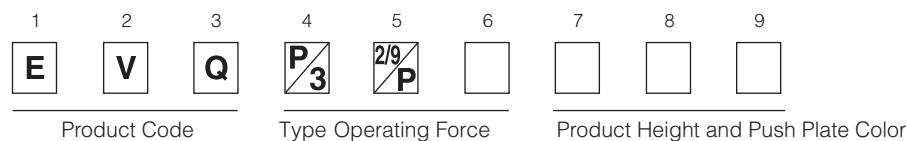

■ Specifications

Travel Type		Middle Push Travel	Short Push Travel
Type		Snap action / Push-on V DC type SPST	
Electrical	Rating	10 μ A 2 V DC to 20 mA 15 V DC (Resistive load)	
	Contact Resistance	100 m Ω max.	
	Insulation Resistance	100 M Ω min. (at 100 V DC)	
	Dielectric Withstanding Voltage	250 V AC (1 minute)	
	Bouncing	10 ms max. (ON, OFF)	
Mechanical	Operating Force	2.5 N, 3.5 N, 5.0 N	1.0 N, 1.6 N, 2.4 N, 3.5 N, 4.0 N, 5.0 N
	Travel	0.70 mm \pm 0.20 mm	0.25 mm ^{+0.05} _{-0.15} mm
Endurance	Operating Life	2.5 N: 1,000,000 cycles min. 3.5 N: 500,000 cycles min. 5.0 N: 200,000 cycles min.	1.0 N, 1.6 N: 1,000,000 cycles min. 2.4 N: 500,000 cycles min. 3.5 N: 200,000 cycles min. 4.0 N: 200,000 cycles min. 5.0 N: 200,000 cycles min.
Operating Temperature		-40 °C to +85 °C	
Storage Temperature		-40 °C to +85 °C (Bulk) -20 °C to +60 °C (Taping)	
Minimum Quantity/Packing Unit		4,000 pcs. Embossed Taping (Reel Pack)	
Quantity/Carton		20,000 pcs.	

Design and specifications are each subject to change without notice. Ask factory for the current technical specifications before purchase and/or use.
Should a safety concern arise regarding this product, please be sure to contact us immediately.

■ Dimensions in mm (not to scale)

<p>No. 1</p> <p>EVQP2 EVQ3P2</p> <p>Middle push travel With J-bent terminals Without Ground Terminal</p>	<p>(General dimension tolerance±0.2)</p>
--	--

Part Numbers	Ground Terminal	Operating Force	Height	Push Plate Color	Operating Life
EVQP2H02B	Without	2.5 N	2.5 mm	Blue	1,000,000 cycles
EVQP2K02Q	Without	3.5 N	2.5 mm	Gray	500,000 cycles
EVQ3P202K	Without	5.0 N	2.5 mm	Black	200,000 cycles

Design and specifications are each subject to change without notice. Ask factory for the current technical specifications before purchase and/or use.
Should a safety concern arise regarding this product, please be sure to contact us immediately.

■ Dimensions in mm (not to scale)

<p>No. 2</p> <p>EVQP2 EVQ3P2</p> <p>Middle push travel With J-bent terminals With Ground Terminal</p> 	<p>(General dimension tolerance : ± 0.2)</p>  <p>Ground terminal</p> <p>① ② ③ ④ Circuit diagram</p> <p>Land pattern plan</p> <p>We recommend to connect the GND land shown in the switch spec. with the GND of your P.C.B for withstanding electric-static discharge.</p>				
<p>Part Numbers</p>	<p>Ground Terminal</p>	<p>Operating Force</p>	<p>Height</p>	<p>Push Plate Color</p>	<p>Operating Life</p>
<p>EVQP2B02B</p>	<p>With</p>	<p>2.5 N</p>	<p>2.5 mm</p>	<p>Blue</p>	<p>1,000,000 cycles</p>
<p>EVQP2D02Q</p>	<p>With</p>	<p>3.5 N</p>	<p>2.5 mm</p>	<p>Gray</p>	<p>500,000 cycles</p>
<p>EVQP2F02K</p>	<p>With</p>	<p>5.0 N</p>	<p>2.5 mm</p>	<p>Black</p>	<p>200,000 cycles</p>

Design and specifications are each subject to change without notice. Ask factory for the current technical specifications before purchase and/or use.
Should a safety concern arise regarding this product, please be sure to contact us immediately.

■ Dimensions in mm (not to scale)

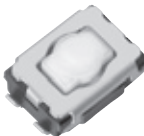
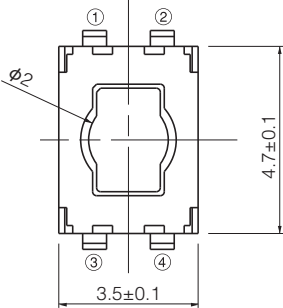
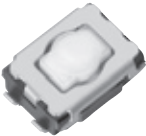
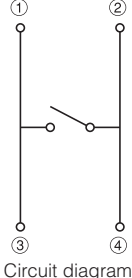
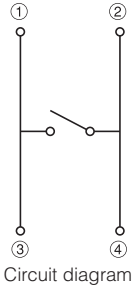
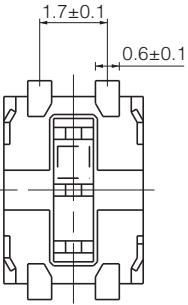
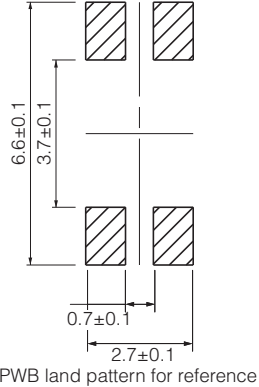
No. 3	(General dimension tolerance±0.2)				
EVQP2 EVQP9					
Short push travel With J-bent terminals Without Ground Terminal					
					
	 <p>Circuit diagram</p>				
					
	 <p>PWB land pattern for reference</p>				
Part Numbers	Ground Terminal	Operating Force	H=Height	Push Plate Color	Operating Life
EVQP2002M	Without	1.0 N	2.1 mm	White	1,000,000 cycles
EVQP2002W	Without	1.0 N	2.5 mm	White	1,000,000 cycles
EVQP2202M	Without	1.6 N	2.1 mm	White	1,000,000 cycles
EVQP2202W	Without	1.6 N	2.5 mm	White	1,000,000 cycles
EVQP2402M	Without	2.4 N	2.1 mm	White	500,000 cycles
EVQP2402W	Without	2.4 N	2.5 mm	White	500,000 cycles
EVQP2602M	Without	3.5 N	2.1 mm	White	200,000 cycles
EVQP2602W	Without	3.5 N	2.5 mm	White	200,000 cycles
EVQP9W02W	Without	4.0 N	2.5 mm	White	200,000 cycles
EVQP9P02M	Without	5.0 N	2.1 mm	White	200,000 cycles
EVQP9P02W	Without	5.0 N	2.5 mm	White	200,000 cycles

Design and specifications are each subject to change without notice. Ask factory for the current technical specifications before purchase and/or use.
Should a safety concern arise regarding this product, please be sure to contact us immediately.

■ Dimensions in mm (not to scale)

No. 4

EVQP2
EVQP9

Short push travel
With J-bent terminals
With
Ground Terminal



(General dimension tolerance±0.2)



Land pattern plan

We recommend to connect the GND land shown in the switch spec. with the GND of your P.C.B for withstanding electric-static discharge.

Part Numbers	Ground Terminal	Operating Force	H=Height	Push Plate Color	Operating Life
EVQP2P02M	With	1.0 N	2.1 mm	White	1,000,000 cycles
EVQP2P02W	With	1.0 N	2.5 mm	White	1,000,000 cycles
EVQP2R02M	With	1.6 N	2.1 mm	White	1,000,000 cycles
EVQP2R02W	With	1.6 N	2.5 mm	White	1,000,000 cycles
EVQP2T02M	With	2.4 N	2.1 mm	White	500,000 cycles
EVQP2T02W	With	2.4 N	2.5 mm	White	500,000 cycles
EVQP2V02M	With	3.5 N	2.1 mm	White	200,000 cycles
EVQP2V02W	With	3.5 N	2.5 mm	White	200,000 cycles
EVQP9H02M	With	5.0 N	2.1 mm	White	200,000 cycles
EVQP9H02W	With	5.0 N	2.5 mm	White	200,000 cycles

Design and specifications are each subject to change without notice. Ask factory for the current technical specifications before purchase and/or use.
Should a safety concern arise regarding this product, please be sure to contact us immediately.

Recommended Reflow Soldering Conditions



Embossed Carrier Taping

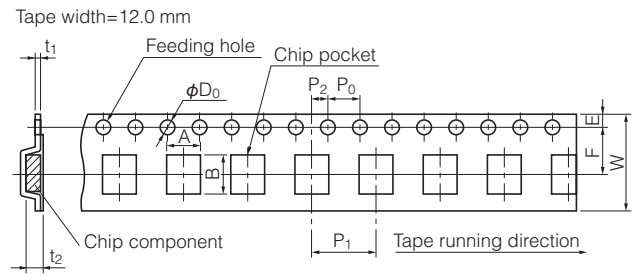

Taping condition : Lack of products in the middle of taping should be one MAX, but total quantity specified in the specifications should be secured.

Peeling off strength of top tape : It should be within 0.2N to 1.0N at 165 degree in peeling off angle.

Joint of carrier tape : One joint per one reel may exist.

Unit: mm

Part No.	Height	A	B	W	F	E	P_1	P_2	P_0	D_0 Dia.	t_1	t_2
EVQP2	2.1	6.0±0.2	4.7±0.2	12.0±0.3	5.5±0.1	1.75±0.10	8.0±0.1	2.0±0.1	4.0±0.1	1.5 ^{+0.1}	0.3±0.1	2.7±0.2
EVQP9	2.5											
EVQ3P2												

Recommended Shape of Test Pole

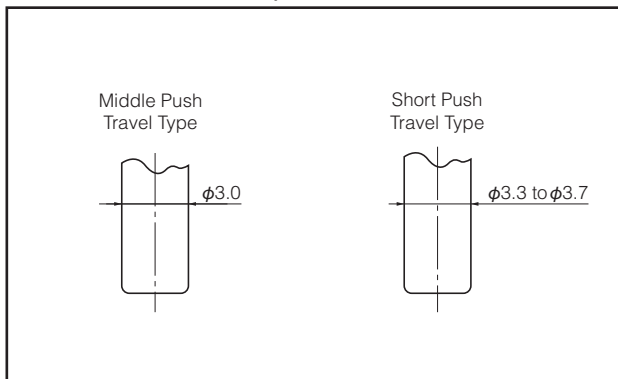

Recommended Operating Conditions

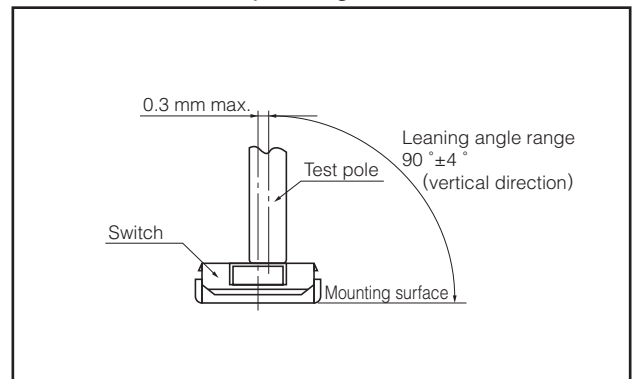

Design and specifications are each subject to change without notice. Ask factory for the current technical specifications before purchase and/or use. Should a safety concern arise regarding this product, please be sure to contact us immediately.

Mouser Electronics

Authorized Distributor

Click to View Pricing, Inventory, Delivery & Lifecycle Information:

Panasonic:

[EVQ-P2002W](#) [EVQ-P2202W](#) [EVQ-3P2F02K](#) [EVQ-P2402M](#) [EVQ-P2T02M](#) [EVQ-P2K02Q](#) [EVQ-P2402W](#) [EVQ-P2B02B](#) [EVQ-P2202M](#) [EVQ-P2V02M](#) [EVQ-3P202K](#) [EVQ-P2002M](#) [EVQ-P2602M](#) [EVQ-P2602W](#) [EVQ-P2D02Q](#) [EVQ-P2F02K](#) [EVQ-P2H02B](#) [EVQ-P2P02M](#) [EVQ-P2P02W](#) [EVQ-P2R02M](#) [EVQ-P2R02W](#) [EVQ-P2T02W](#) [EVQ-P2V02W](#) [EVQ-P9P02M](#) [EVQ-P9H02W](#) [EVQ-P9P02W](#) [EVQ-P9H02M](#) [EVQ-P9W02W](#) [EVQ-P9102M](#) [EVQ-P9102W](#) [EVQ-P9W02M](#)



Компания «ЭлектроПласт» предлагает заключение долгосрочных отношений при поставках импортных электронных компонентов на взаимовыгодных условиях!

Наши преимущества:

- Оперативные поставки широкого спектра электронных компонентов отечественного и импортного производства напрямую от производителей и с крупнейших мировых складов;
- Поставка более 17-ти миллионов наименований электронных компонентов;
- Поставка сложных, дефицитных, либо снятых с производства позиций;
- Оперативные сроки поставки под заказ (от 5 рабочих дней);
- Экспресс доставка в любую точку России;
- Техническая поддержка проекта, помощь в подборе аналогов, поставка прототипов;
- Система менеджмента качества сертифицирована по Международному стандарту ISO 9001;
- Лицензия ФСБ на осуществление работ с использованием сведений, составляющих государственную тайну;
- Поставка специализированных компонентов (Xilinx, Altera, Analog Devices, Intersil, Interpoint, Microsemi, Aeroflex, Peregrine, Syfer, Eurofarad, Texas Instrument, Miteq, Cobham, E2V, MA-COM, Hittite, Mini-Circuits, General Dynamics и др.);

Помимо этого, одним из направлений компании «ЭлектроПласт» является направление «Источники питания». Мы предлагаем Вам помощь Конструкторского отдела:

- Подбор оптимального решения, техническое обоснование при выборе компонента;
- Подбор аналогов;
- Консультации по применению компонента;
- Поставка образцов и прототипов;
- Техническая поддержка проекта;
- Защита от снятия компонента с производства.



Как с нами связаться

Телефон: 8 (812) 309 58 32 (многоканальный)

Факс: 8 (812) 320-02-42

Электронная почта: org@eplast1.ru

Адрес: 198099, г. Санкт-Петербург, ул. Калинина, дом 2, корпус 4, литера А.