

4.7 mm×3.5 mm SMD Light Touch Switches

Type: **EVQP2/EVQP9/EVQ3P2**

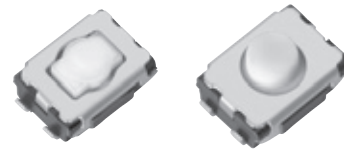

■ Features

- External dimensions : 4.7 mm×3.5 mm,
Height : Middle Push Travel 2.5 mm
Short Push Travel 2.1 mm, 2.5 mm
- High operating force and long operational life
- High mountability with J-bent (4 terminals)

■ Recommended Applications

- Operation switches for portable electronic equipment
(Mobile phones, Digital still cameras, Camcorders,
Portable audio players, etc.)
- Keyless entry systems (automotive)
- Car audio equipment

■ Explanation of Part Numbers

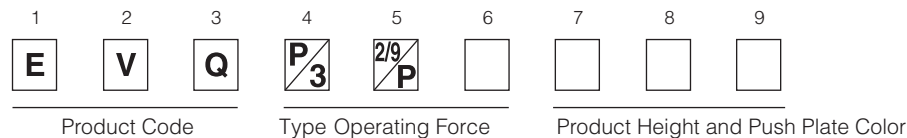

■ Specifications

Travel Type		Middle Push Travel	Short Push Travel
Type		Snap action / Push-on V DC type SPST	
Electrical	Rating	10 μA 2 V DC to 20 mA 15 V DC (Resistive load)	
	Contact Resistance	100 mΩ max.	
	Insulation Resistance	100 MΩ min. (at 100 V DC)	
	Dielectric Withstanding Voltage	250 V AC (1 minute)	
	Bouncing	10 ms max. (ON, OFF)	
Mechanical	Operating Force	2.5 N, 3.5 N, 5.0 N	1.0 N, 1.6 N, 2.4 N, 3.5 N, 4.0 N, 5.0 N
	Travel	0.70 mm±0.20 mm	0.25 mm ^{+0.05} _{-0.15} mm
Endurance	Operating Life	2.5 N: 1,000,000 cycles min. 3.5 N: 500,000 cycles min. 5.0 N: 200,000 cycles min.	1.0 N, 1.6 N: 1,000,000 cycles min. 2.4 N: 500,000 cycles min. 3.5 N: 200,000 cycles min. 4.0 N: 200,000 cycles min. 5.0 N: 200,000 cycles min.
Operating Temperature		-40 °C to +85 °C	
Storage Temperature		-40 °C to +85 °C (Bulk) -20 °C to +60 °C (Taping)	
Minimum Quantity/Packing Unit		4,000 pcs. Embossed Taping (Reel Pack)	
Quantity/Carton		20,000 pcs.	

Design and specifications are each subject to change without notice. Ask factory for the current technical specifications before purchase and/or use.
Should a safety concern arise regarding this product, please be sure to contact us immediately.

■ Dimensions in mm (not to scale)

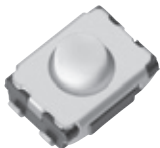
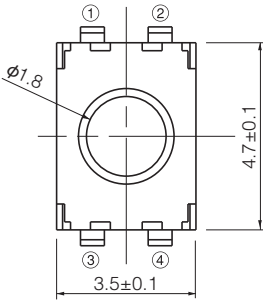
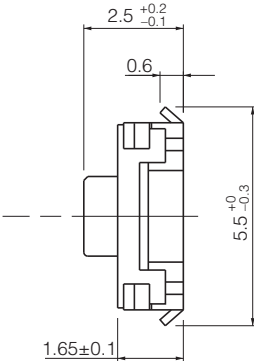
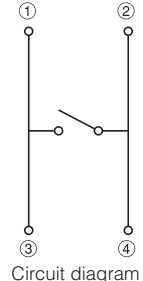
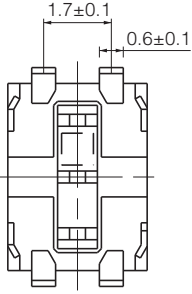
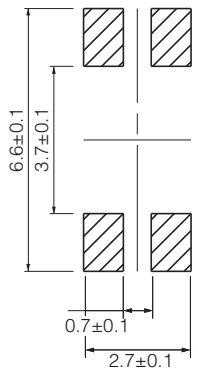
<p>No. 1</p> <p>EVQP2 EVQ3P2</p> <p>Middle push travel With J-bent terminals Without Ground Terminal</p> 	<p>(General dimension tolerance±0.2)</p>    <p>Circuit diagram</p>   <p>PWB land pattern for reference</p>				
<p>Part Numbers</p>	<p>Ground Terminal</p>	<p>Operating Force</p>	<p>Height</p>	<p>Push Plate Color</p>	<p>Operating Life</p>
<p>EVQP2H02B</p>	<p>Without</p>	<p>2.5 N</p>	<p>2.5 mm</p>	<p>Blue</p>	<p>1,000,000 cycles</p>
<p>EVQP2K02Q</p>	<p>Without</p>	<p>3.5 N</p>	<p>2.5 mm</p>	<p>Gray</p>	<p>500,000 cycles</p>
<p>EVQ3P202K</p>	<p>Without</p>	<p>5.0 N</p>	<p>2.5 mm</p>	<p>Black</p>	<p>200,000 cycles</p>

Design and specifications are each subject to change without notice. Ask factory for the current technical specifications before purchase and/or use.
Should a safety concern arise regarding this product, please be sure to contact us immediately.

■ Dimensions in mm (not to scale)

<p>No. 2</p> <p>EVQP2 EVQ3P2</p> <p>Middle push travel With J-bent terminals With Ground Terminal</p> 	<p>(General dimension tolerance : ± 0.2)</p>  <p>Ground terminal</p> <p>① ② ③ ④ Circuit diagram</p> <p>Land pattern plan</p> <p>We recommend to connect the GND land shown in the switch spec. with the GND of your P.C.B for withstanding electric-static discharge.</p>				
<p>Part Numbers</p>	<p>Ground Terminal</p>	<p>Operating Force</p>	<p>Height</p>	<p>Push Plate Color</p>	<p>Operating Life</p>
<p>EVQP2B02B</p>	<p>With</p>	<p>2.5 N</p>	<p>2.5 mm</p>	<p>Blue</p>	<p>1,000,000 cycles</p>
<p>EVQP2D02Q</p>	<p>With</p>	<p>3.5 N</p>	<p>2.5 mm</p>	<p>Gray</p>	<p>500,000 cycles</p>
<p>EVQP2F02K</p>	<p>With</p>	<p>5.0 N</p>	<p>2.5 mm</p>	<p>Black</p>	<p>200,000 cycles</p>

Design and specifications are each subject to change without notice. Ask factory for the current technical specifications before purchase and/or use.
Should a safety concern arise regarding this product, please be sure to contact us immediately.

■ Dimensions in mm (not to scale)

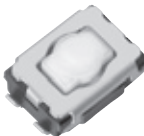
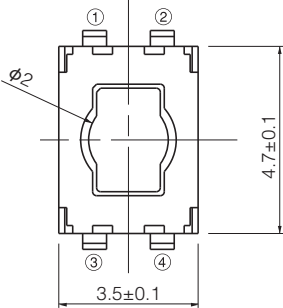
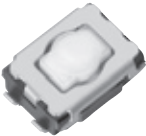
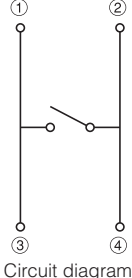
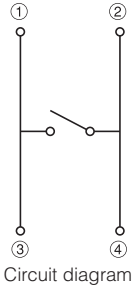
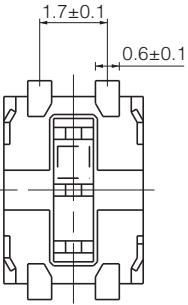
No. 3	(General dimension tolerance±0.2)				
EVQP2 EVQP9	<p data-bbox="153 353 392 465">Short push travel With J-bent terminals Without Ground Terminal</p>       <p data-bbox="1166 835 1297 857">Circuit diagram</p> <p data-bbox="1098 1317 1297 1339">PWB land pattern for reference</p>				
Part Numbers	Ground Terminal	Operating Force	H=Height	Push Plate Color	Operating Life
EVQP2002M	Without	1.0 N	2.1 mm	White	1,000,000 cycles
EVQP2002W	Without	1.0 N	2.5 mm	White	1,000,000 cycles
EVQP2202M	Without	1.6 N	2.1 mm	White	1,000,000 cycles
EVQP2202W	Without	1.6 N	2.5 mm	White	1,000,000 cycles
EVQP2402M	Without	2.4 N	2.1 mm	White	500,000 cycles
EVQP2402W	Without	2.4 N	2.5 mm	White	500,000 cycles
EVQP2602M	Without	3.5 N	2.1 mm	White	200,000 cycles
EVQP2602W	Without	3.5 N	2.5 mm	White	200,000 cycles
EVQP9W02W	Without	4.0 N	2.5 mm	White	200,000 cycles
EVQP9P02M	Without	5.0 N	2.1 mm	White	200,000 cycles
EVQP9P02W	Without	5.0 N	2.5 mm	White	200,000 cycles

Design and specifications are each subject to change without notice. Ask factory for the current technical specifications before purchase and/or use.
Should a safety concern arise regarding this product, please be sure to contact us immediately.

■ Dimensions in mm (not to scale)

No. 4

EVQP2
EVQP9

Short push travel
With J-bent terminals
With
Ground Terminal



(General dimension tolerance±0.2)



Circuit diagram

Land pattern plan

We recommend to connect the GND land shown in the switch spec. with the GND of your P.C.B for withstanding electric-static discharge.

Part Numbers	Ground Terminal	Operating Force	H=Height	Push Plate Color	Operating Life
EVQP2P02M	With	1.0 N	2.1 mm	White	1,000,000 cycles
EVQP2P02W	With	1.0 N	2.5 mm	White	1,000,000 cycles
EVQP2R02M	With	1.6 N	2.1 mm	White	1,000,000 cycles
EVQP2R02W	With	1.6 N	2.5 mm	White	1,000,000 cycles
EVQP2T02M	With	2.4 N	2.1 mm	White	500,000 cycles
EVQP2T02W	With	2.4 N	2.5 mm	White	500,000 cycles
EVQP2V02M	With	3.5 N	2.1 mm	White	200,000 cycles
EVQP2V02W	With	3.5 N	2.5 mm	White	200,000 cycles
EVQP9H02M	With	5.0 N	2.1 mm	White	200,000 cycles
EVQP9H02W	With	5.0 N	2.5 mm	White	200,000 cycles

Design and specifications are each subject to change without notice. Ask factory for the current technical specifications before purchase and/or use. Should a safety concern arise regarding this product, please be sure to contact us immediately.

Recommended Reflow Soldering Conditions



Embossed Carrier Taping

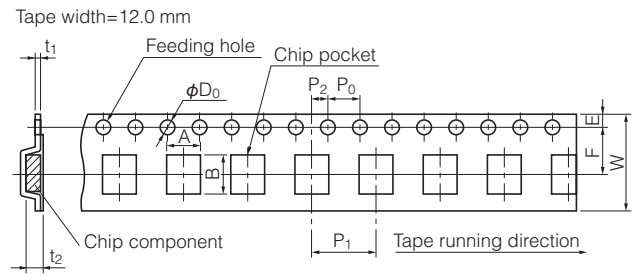

Taping condition : Lack of products in the middle of taping should be one MAX, but total quantity specified in the specifications should be secured.

Peeling off strength of top tape : It should be within 0.2N to 1.0N at 165 degree in peeling off angle.

Joint of carrier tape : One joint per one reel may exist.

Unit: mm

Part No.	Height	A	B	W	F	E	P_1	P_2	P_0	D_0 Dia.	t_1	t_2
EVQP2	2.1	6.0±0.2	4.7±0.2	12.0±0.3	5.5±0.1	1.75±0.10	8.0±0.1	2.0±0.1	4.0±0.1	1.5 ^{+0.1} ₀	0.3±0.1	2.7±0.2
EVQP9	2.5											
EVQ3P2												

Recommended Shape of Test Pole

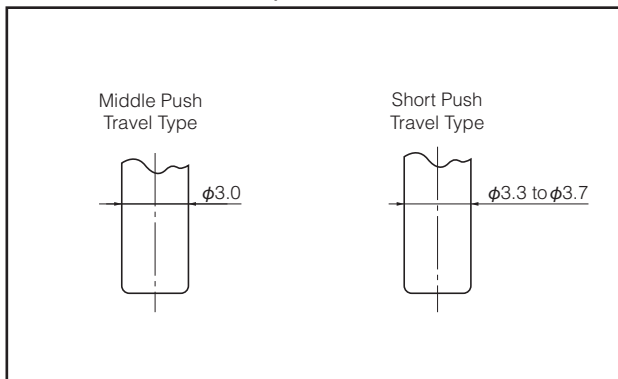

Recommended Operating Conditions

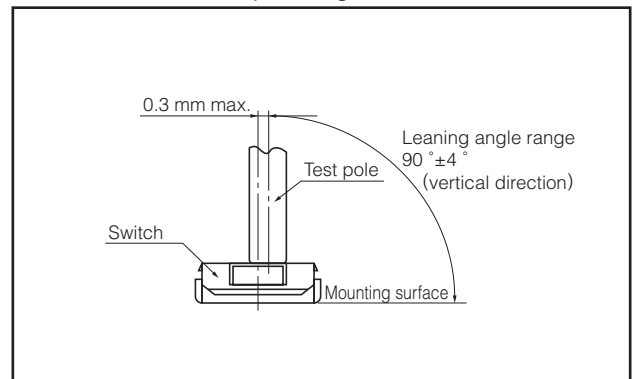

Mouser Electronics

Authorized Distributor

Click to View Pricing, Inventory, Delivery & Lifecycle Information:

Panasonic:

[EVQ-P2002W](#) [EVQ-P2202W](#) [EVQ-3P2F02K](#) [EVQ-P2402M](#) [EVQ-P2T02M](#) [EVQ-P2K02Q](#) [EVQ-P2402W](#) [EVQ-P2B02B](#) [EVQ-P2202M](#) [EVQ-P2V02M](#) [EVQ-3P202K](#) [EVQ-P2002M](#) [EVQ-P2602M](#) [EVQ-P2602W](#) [EVQ-P2D02Q](#) [EVQ-P2F02K](#) [EVQ-P2H02B](#) [EVQ-P2P02M](#) [EVQ-P2P02W](#) [EVQ-P2R02M](#) [EVQ-P2R02W](#) [EVQ-P2T02W](#) [EVQ-P2V02W](#) [EVQ-P9P02M](#) [EVQ-P9H02W](#) [EVQ-P9P02W](#) [EVQ-P9H02M](#) [EVQ-P9W02W](#) [EVQ-P9102M](#) [EVQ-P9102W](#) [EVQ-P9W02M](#)



Компания «ЭлектроПласт» предлагает заключение долгосрочных отношений при поставках импортных электронных компонентов на взаимовыгодных условиях!

Наши преимущества:

- Оперативные поставки широкого спектра электронных компонентов отечественного и импортного производства напрямую от производителей и с крупнейших мировых складов;
- Поставка более 17-ти миллионов наименований электронных компонентов;
- Поставка сложных, дефицитных, либо снятых с производства позиций;
- Оперативные сроки поставки под заказ (от 5 рабочих дней);
- Экспресс доставка в любую точку России;
- Техническая поддержка проекта, помощь в подборе аналогов, поставка прототипов;
- Система менеджмента качества сертифицирована по Международному стандарту ISO 9001;
- Лицензия ФСБ на осуществление работ с использованием сведений, составляющих государственную тайну;
- Поставка специализированных компонентов (Xilinx, Altera, Analog Devices, Intersil, Interpoint, Microsemi, Aeroflex, Peregrine, Syfer, Eurofarad, Texas Instrument, Miteq, Cobham, E2V, MA-COM, Hittite, Mini-Circuits, General Dynamics и др.);

Помимо этого, одним из направлений компании «ЭлектроПласт» является направление «Источники питания». Мы предлагаем Вам помощь Конструкторского отдела:

- Подбор оптимального решения, техническое обоснование при выборе компонента;
- Подбор аналогов;
- Консультации по применению компонента;
- Поставка образцов и прототипов;
- Техническая поддержка проекта;
- Защита от снятия компонента с производства.



Как с нами связаться

Телефон: 8 (812) 309 58 32 (многоканальный)

Факс: 8 (812) 320-02-42

Электронная почта: org@eplast1.ru

Адрес: 198099, г. Санкт-Петербург, ул. Калинина, дом 2, корпус 4, литера А.