

# VRAE-03E1A0 Series

## Non-Isolated DC-DC Converter

### MicroSIP Series

The Bel VRAE-03E1A Series is a part of the non-isolated DC/DC converter Power Module series. The modules use a SIP package. These converters are available in a range of output voltages from 0.59 VDC to 5.1 VDC over a wide range of input voltage 4.5 VDC -13.8 VDC. The efficiency is typically 91% at 3.3 Vout ( $V_{in} = 12$  VDC) at full load.

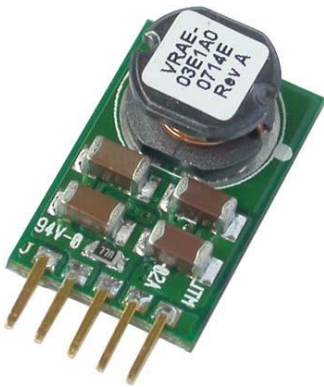

#### Key Features & Benefits

- Wide Input Voltage Range 4.5 VDC – 13.8 VDC
- 0.59 VDC – 5.1 VDC / 3 A Output
- Non-Isolated
- High Efficiency
- Fixed Frequency
- Low Cost
- Under-Voltage Lockout
- OCP/SCP
- Remote On/Off
- Class II, Category 2, Non-Isolated DC/DC Converter (refer to IPC-9592B)
- UL60950-1-2 2nd Edition Recognized (UL/cUL)

#### Applications

- Networking
- Computers and Peripherals
- Telecommunications



**bel** POWER  
SOLUTIONS &  
PROTECTION

a bel group

[belfuse.com/power-solutions](http://belfuse.com/power-solutions)

## 1. MODEL SELECTION

PART NUMBER	OUTPUT VOLTAGE	INPUT VOLTAGE	MAX. OUTPUT CURRENT	MAX. OUTPUT POWER	TYPICAL EFFICIENCY
VRAE-03E1A0	0.59 VDC - 5.1 VDC	4.5 VDC - 13.8 VDC	3 A	15 W	91%

### PART NUMBER EXPLANATION

V	R	AE	-	03	E	1A	x	x
Mount Type	RoHS	Series Name		Output Current	Input Range	Output Voltage	Suffix	Package
Vertical Mount	RoHS 6 Compliant	SIP		3 A	4.5 - 13.8 V	0.59 - 5.1 V	0 – Active High	G – Tray Packaging

## 2. ABSOLUTE MAXIMUM RATINGS

PARAMETER	DESCRIPTION	MIN	TYP	MAX	UNITS
Input Supply Voltage		-0.3	-	15	V
Ambient Temperature		-40	-	85	°C
Storage Temperature		-55	-	125	°C
Altitude		-	-	2000	m

**NOTE:** All specifications are typical at 25 °C unless otherwise stated.

## 3. INPUT SPECIFICATIONS

PARAMETER	DESCRIPTION	MIN	TYP	MAX	UNIT
Input Voltage	$V_o \leq 3.63$ V	4.5	-	13.8	V
	$V_o > 3.63$ V	7.0	-	13.8	
Input Current (Full load)	An input line fuse must always be used.	-	-	3	A
Input Current (No load)		-	40	100	mA
Remote Off Input Current		-	10	25	mA
Input Reflected Ripple Current (pk-pk)	With simulated source impedance of 1000 nH, 5 Hz to 20 MHz Use a 1000 $\mu$ F / 25 V AL-Cap with ESR = 0.03 ohm max and 2*100 $\mu$ F/25V Tan-Cap with ESR = 0.013 ohm max at 100 kHz @ 25°C.	-	30	50	mA
Input Reflected Ripple Current (rms)		-	10	20	mA
I <sup>2</sup> t Inrush Current Transient		-	-	1	A <sup>2</sup> s
Turn-on Voltage Threshold	A 30.1K resistor is connected from Enable to Vin	4.15	4.3	4.45	V
Turn-off Voltage Threshold		3.7	4.1	4.3	V

**NOTE:** All specifications are typical at 25 °C unless otherwise stated.

## 4. OUTPUT SPECIFICATIONS

PARAMETER	DESCRIPTION	MIN	TYP	MAX	UNIT
Output Voltage Set Point Accuracy	Vin = 12 V, Iout = full load	-2	-	+2	% Vo, set
Load Regulation		-	±0.2	±0.5	% Vo, set
Line Regulation		-	±0.2	±0.5	% Vo, set
Regulation Over Temperature		-	0.3	0.5	% Vo, set
Output Current		0	-	3	A
Output DC Current Limit		3.6	5	7	A
Output Ripple and Noise (pk-pk)	0 – 20 MHz BW, with a 1 µF ceramic capacitor and a 10 µF tantalum cap at output.	-	60	100	mV
Output Ripple and Noise (rms)		-	20	40	mV
Short Circuit Surge Transient		-	-	2	A²s
Turn-on Time <sup>1</sup>	Vout = 5.0V; time from enable going high to 90% of Vout	2	-	4	ms
	Vout = 3.3V; time from enable going high to 90% of Vout	1.8	-	3.8	ms
	Vout = 1.8V; time from enable going high to 90% of Vout	1	-	3	ms
	Vout = 0.9V; time from enable going high to 90% of Vout	1	-	3	ms
Rise Time <sup>1</sup>	Vout = 5.0V; time from 10% to 90% of Vout	-	2.3	2.8	ms
	Vout = 3.3V; time from 10% to 90% of Vout	-	1.7	2.2	ms
	Vout = 1.8V; time from 10% to 90% of Vout	-	1.2	1.7	ms
	Vout = 0.9V; time from 10% to 90% of Vout	-	1.0	1.5	ms
Overshoot at Turn-on		-	-	1	%
Output Capacitance		0	-	1000	µF
TRANSIENT RESPONSE					
50% ~ 100% Max Load		-	120	200	mV
Settling Time	di/dt = 2.5 A/µS; Vin =12 V; with 10 µF tantalum cap and 1 µF ceramic at the output, Ta=25 °C	-	20	50	µs
100% ~ 50% Max Load		-	120	200	mV
Settling Time		-	20	50	µs

<sup>1</sup> The turn on time is guaranteed to be in between the minimum and maximum limits specified over all operating temperatures. Output capacitance used was 1x 1000 µF aluminum, 1x 10 µF tantalum, and 1x 1 µF ceramic. The turn on waveform with parameter measurement locations is shown below.

**NOTE:** All specifications are typical at normal input, full load at Ta= 25°C unless otherwise stated.

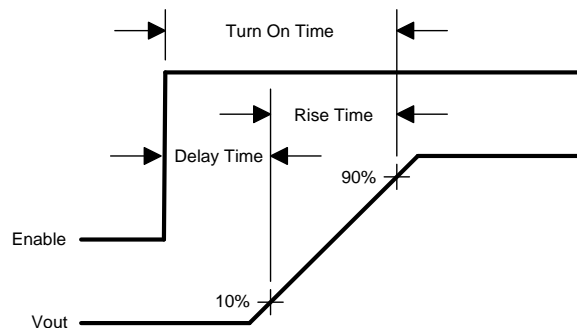

## 5. GENERAL SPECIFICATIONS

PARAMETER	DESCRIPTION	MIN	TYP	MAX	UNIT
Efficiency	$V_o = 5.0\text{ V}$	91	93	-	%
	$V_o = 3.3\text{ V}$	89	91	-	
	$V_o = 2.5\text{ V}$	87	89	-	
	$V_o = 1.8\text{ V}$	84	86	-	
	$V_o = 1.5\text{ V}$	83	85	-	
	$V_o = 1.2\text{ V}$	80	82	-	
	$V_o = 0.9\text{ V}$	73	75	-	
Switching Frequency		-	500	-	kHz
Output Voltage Trim Range	Wide Trim	0.591	-	5.1	V
MTBF	Calculated Per Bell Core SR-332 ( $I_o = 80\%$ load; $V_{in} = 12\text{ V}$ ; $V_o = 5\text{ V}$ ; 200 LFM; $T_a = 25\text{ }^\circ\text{C}$ )		7 579 849		h
Weight		-	2.0	-	g
Dimensions (L x W x H)		0.65 x 0.41 x 0.32			in
		16.51 x 10.41 x 8.13			mm

**NOTE:** All specifications are typical at 25 °C unless otherwise stated.

## 6. CONTROL SPECIFICATIONS

PARAMETER	DESCRIPTION	MIN	TYP	MAX	UNIT
<b>Remote On/Off (Active High)</b>					
Turn On Voltage Threshold	Unit is on when voltage on enable pin is driven above the turn on threshold. When enable pin is floating, unit is off.	0.485	0.500	0.515	V
Maximum Enable Voltage	Maximum voltage that should be applied to the enable pin.	-	-	5.5	V
Hysteresis Source Current	A 10 $\mu\text{A}$ current source to GND ( $I_{EN\_HYS}$ ) is active when unit is off and inactive when unit is on (see figure below).	7.5	10	11.5	$\mu\text{A}$

**NOTE:** The following figure shows the internal circuitry for the enable.

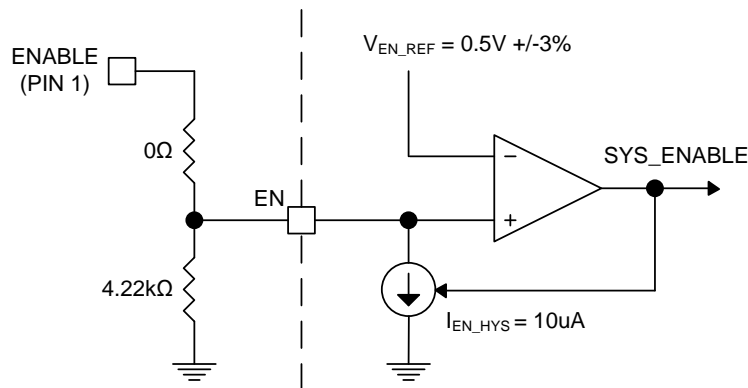

## 7. OUTPUT TRIM EQUATIONS

Equation for calculating the trim resistor given the desired output voltage ( $V_o$ ) is shown below. The  $R_{trim}$  resistor should be connected between the trim pin and GND pin.

$$R_{trim} = \frac{1.182}{V_o - 0.591} k\Omega$$

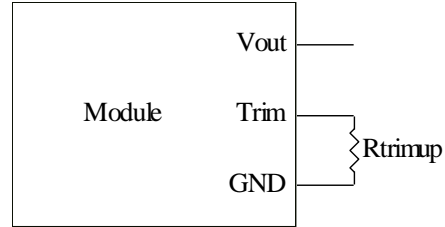

## 8. RIPPLE AND NOISE WAVEFORM

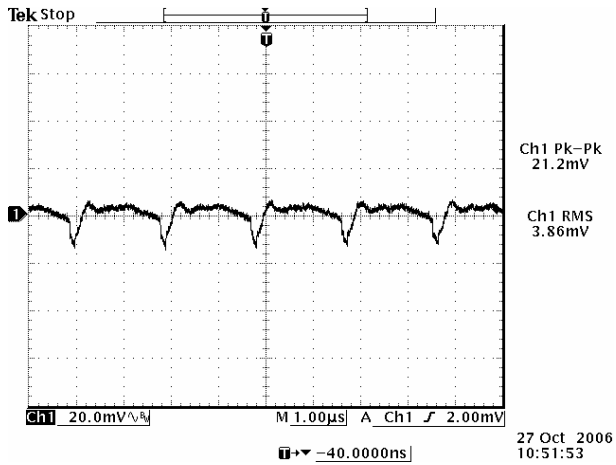

Figure 6. 12 V input, 0.591 V output

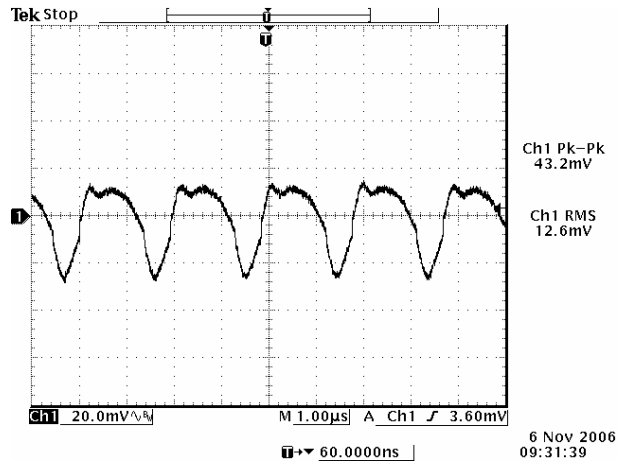

Figure 7. 12 V input, 3.3 V output.

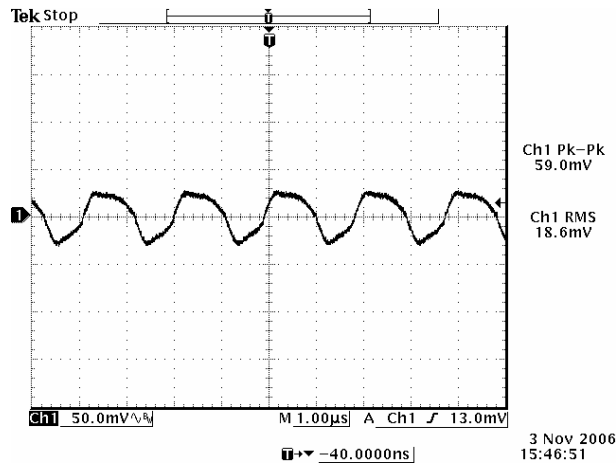
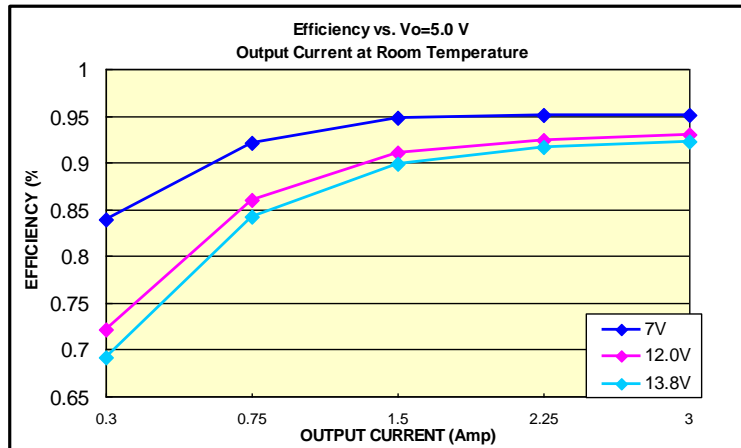
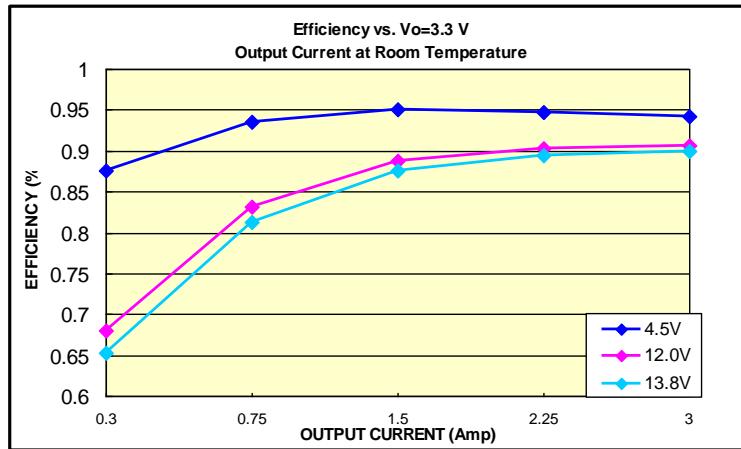
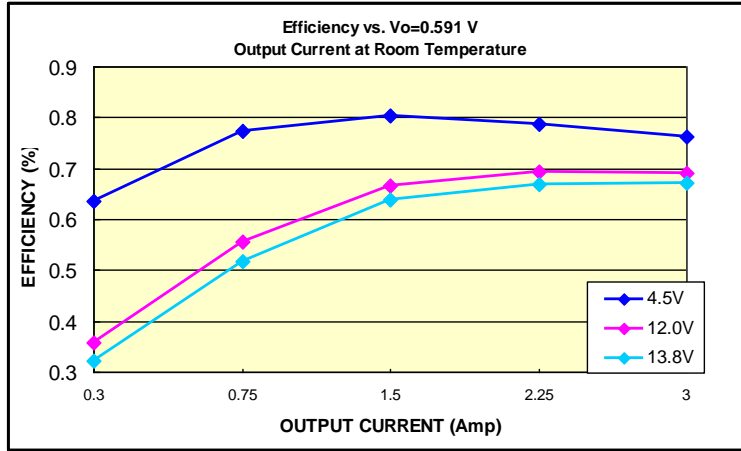

Figure 8. 12 V input, 5.0 V output.

**NOTE:** Ripple and noise at full load, 0-20 MHz BW, with a 1  $\mu$ F ceramic cap and a 10  $\mu$ F tantalum cap, and  $T_a=25^\circ\text{C}$ .

9. EFFICIENCY DATA



## 10. THERMAL DERATING CURVES

The thermal reference point  $T_{ref}$  is shown below. For reliable operation this temperature should not exceed 115 °C. The output power of the module should not exceed the rated power for the module.

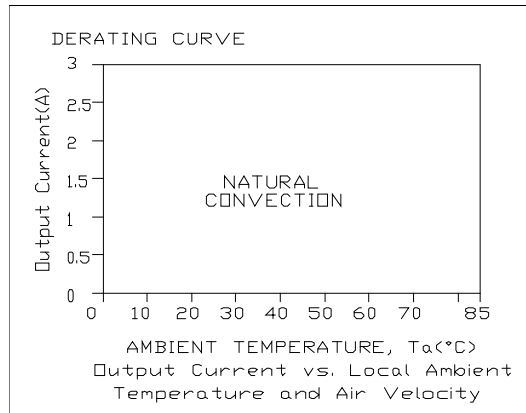
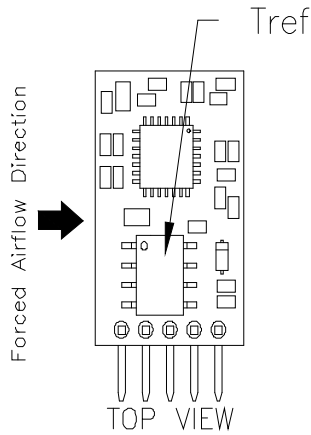

Figure 1.  $V_{in}=12\text{ V}$ ,  $V_{out} = 5\text{ V}$

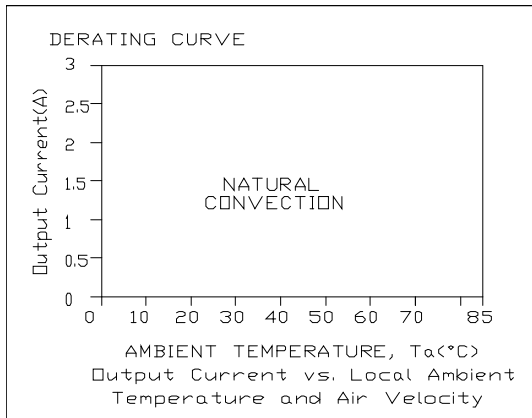

Figure 2.  $V_{in}=12\text{ V}$ ,  $V_{out} = 3.3\text{ V}$

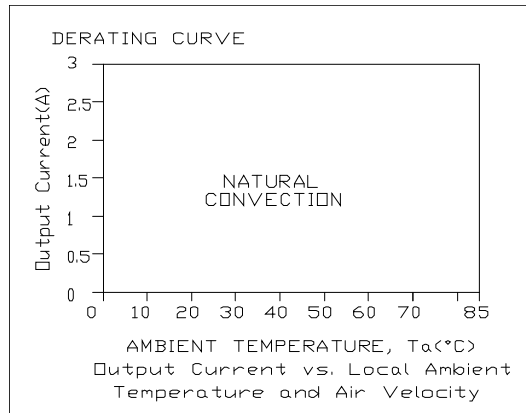

Figure 3.  $V_{in}=12\text{ V}$ ,  $V_{out} = 2.5\text{ V}$

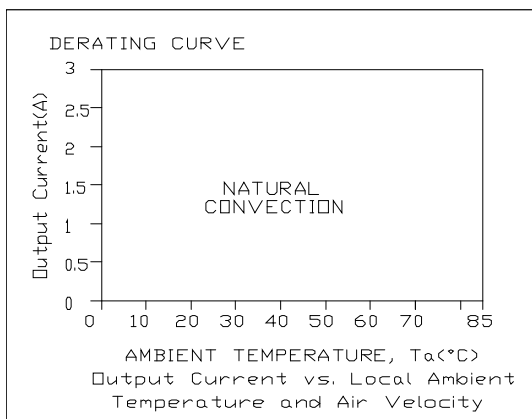

Figure 4.  $V_{in}=12\text{ V}$ ,  $V_{out} = 1.2\text{ V}$

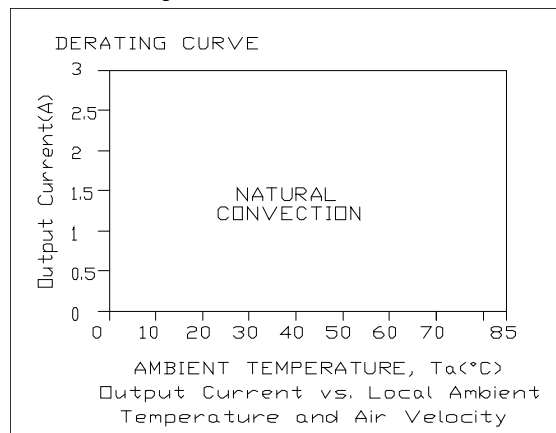

Figure 5.  $V_{in}=12\text{ V}$ ,  $V_{out} = 0.59\text{ V}$

11. TRANSIENT RESPONSE WAVEFORMS

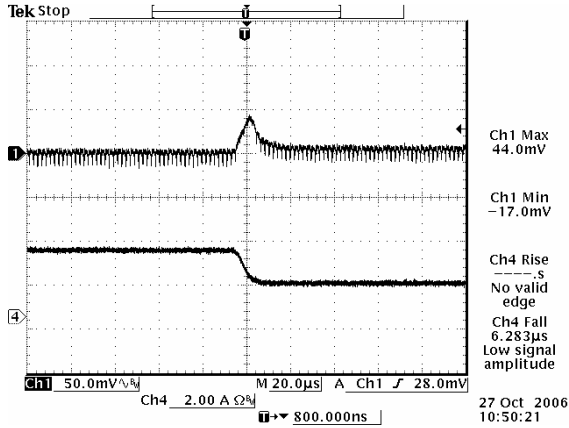

Figure 9. 100% to 50% load step at 12 V input, 0.591 V output

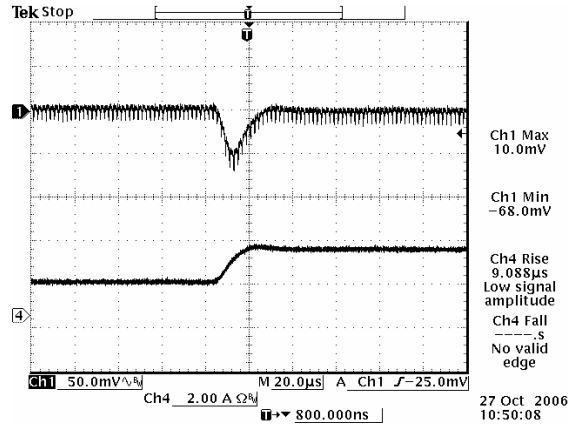

Figure 10. 50% to 100% load step at 12 V input, 0.591 V output

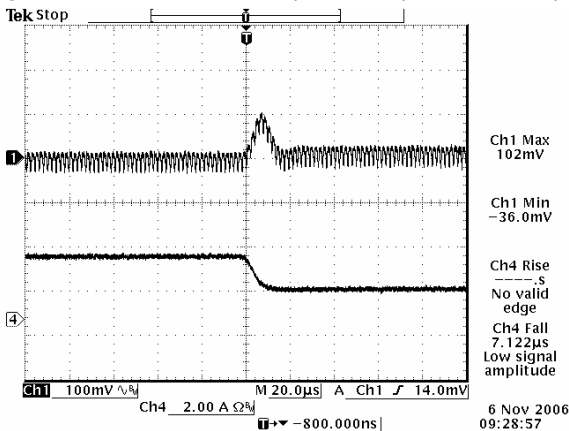

Figure 11. 100% to 50% load step at 12 V input, 3.3 V output

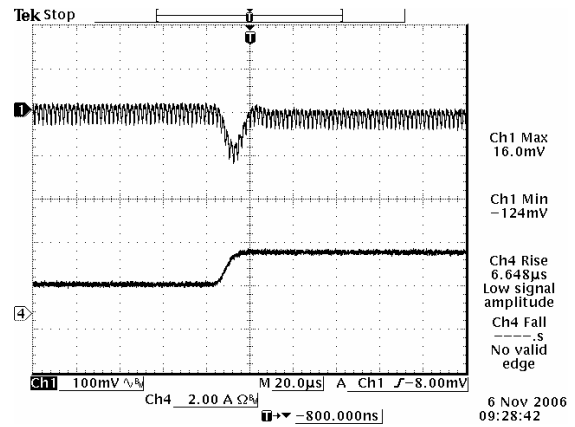

Figure 12. 50% to 100% load step at 12 V input, 3.3 V output

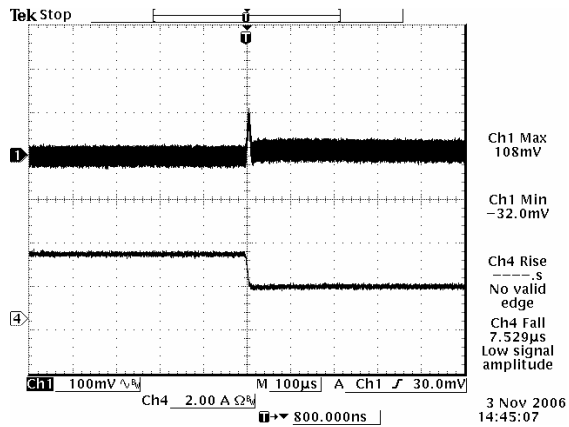

Figure 13. 100% to 50% load step at 12 V input, 5.0 V output

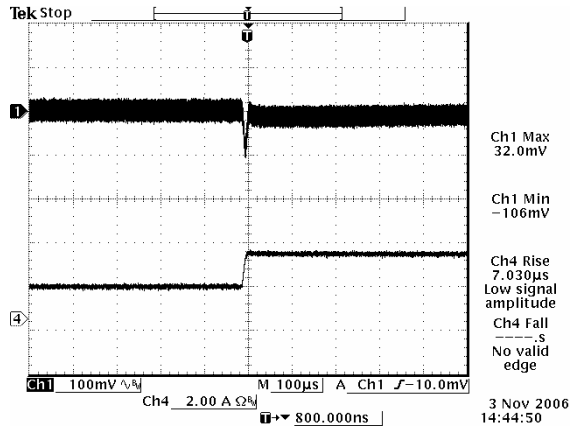
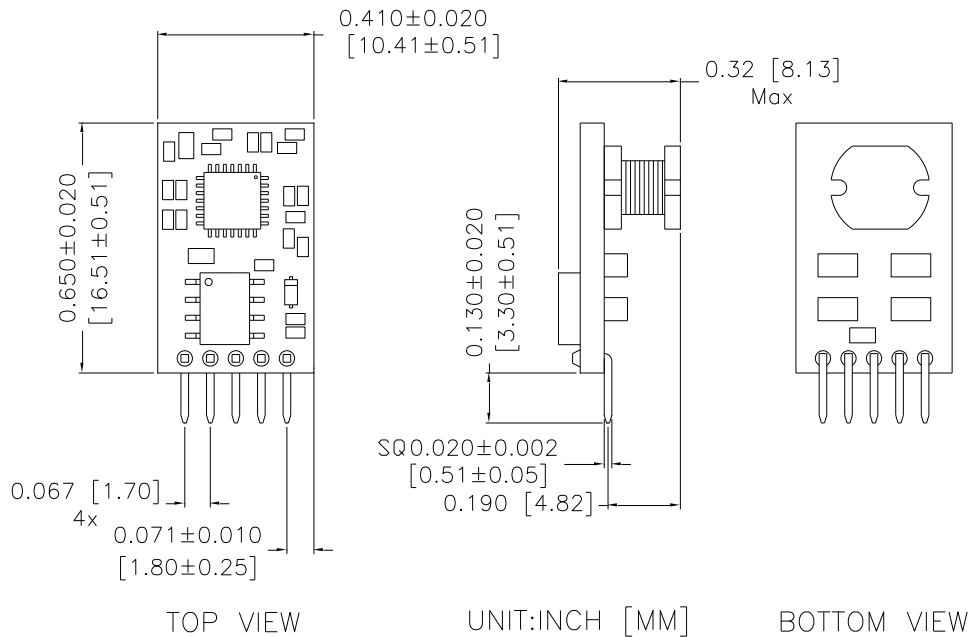

Figure 14. 50% to 100% load step at 12 V input, 5.0 V output

NOTE: Transient response at di/dt=0.25 A/µs, with a 1µF ceramic cap and a 10µF tantalum cap at the output, and Ta=25 °C.



## 12. MECHANICAL OUTLINE



### RECOMMENDED PAD LAYOUT

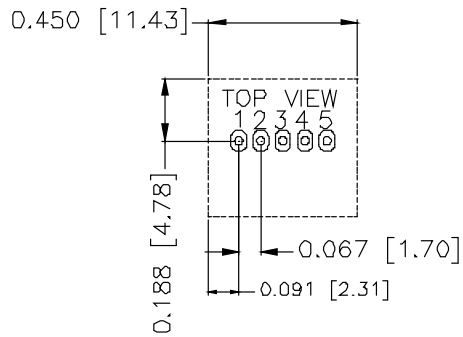

PAD: LENGTH 0.067 [ø1.7] BOTH SIDE  
 WIDTH 0.047 [ø1.2] BOTH SIDE  
 HOLE: ø0.032 [ø0.8] BOTH SIDE

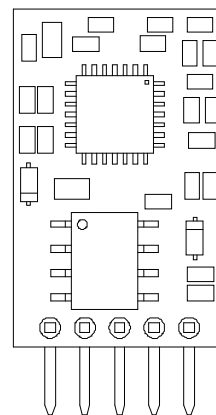

TOP VIEW

### PIN CONNECTIONS

PIN	NAME
1	ENABLE
2	Vin
3	GND
4	Vout
5	Trim

**NOTE:** This module is recommended and compatible with Pb-Free Wave Soldering and must be soldered using a peak solder temperature of no more than 260°C for less than 5 seconds.

#### NOTES:

- 1) All Pins: Material - Copper Alloy;  
Finish - 3 micro inches minimum Gold over 50 micro inches minimum Nickel plate.
- 2) Undimensioned components are shown for visual reference only.
- 3) All dimensions in inches (mm); Tolerances: x.xx +/-0.02 in [0.5 mm]. x.xxx +/-0.010 in [0.25 mm].

### 13. ASSEMBLY NOTE

Modules were designed for vertical insertion into host board. Experiments should be performed to make sure that the units meet the intended tilt specification. A fixture may be needed to make the module stand upright in assembly.

### 14. REVISION HISTORY

DATE	REVISION	CHANGE DESCRIPTION	APPROVAL
2010-4-22	G	1. Change operating temp range from 0~70°C to -40~85°C 2. Add the data of full load input current	XF JIANG
2013-4-11	H	Update Output Specifications and Control Specifications.	XF JIANG
2014-3-24	I	Update MD	Shiyong Qian
2015-12-28	J	Update MD	XF JIANG
2017-12-15	K	Datasheet updated to the new Bel template	

For more information on these products consult: [tech.support@psbel.com](mailto:tech.support@psbel.com)

**NUCLEAR AND MEDICAL APPLICATIONS** - Products are not designed or intended for use as critical components in life support systems, equipment used in hazardous environments, or nuclear control systems.

**TECHNICAL REVISIONS** - The appearance of products, including safety agency certifications pictured on labels, may change depending on the date manufactured. Specifications are subject to change without notice.



[tech.support@psbel.com](mailto:tech.support@psbel.com)  
[belfuse.com/power-solutions](http://belfuse.com/power-solutions)



**Asia-Pacific**  
+86 755 298 85888

**Europe, Middle East**  
+353 61 225 977

**North America**  
+1 408 785 5200



Компания «ЭлектроПласт» предлагает заключение долгосрочных отношений при поставках импортных электронных компонентов на взаимовыгодных условиях!

Наши преимущества:

- Оперативные поставки широкого спектра электронных компонентов отечественного и импортного производства напрямую от производителей и с крупнейших мировых складов;
- Поставка более 17-ти миллионов наименований электронных компонентов;
- Поставка сложных, дефицитных, либо снятых с производства позиций;
- Оперативные сроки поставки под заказ (от 5 рабочих дней);
- Экспресс доставка в любую точку России;
- Техническая поддержка проекта, помощь в подборе аналогов, поставка прототипов;
- Система менеджмента качества сертифицирована по Международному стандарту ISO 9001;
- Лицензия ФСБ на осуществление работ с использованием сведений, составляющих государственную тайну;
- Поставка специализированных компонентов (Xilinx, Altera, Analog Devices, Intersil, Interpoint, Microsemi, Aeroflex, Peregrine, Syfer, Eurofarad, Texas Instrument, Miteq, Cobham, E2V, MA-COM, Hittite, Mini-Circuits, General Dynamics и др.);

Помимо этого, одним из направлений компании «ЭлектроПласт» является направление «Источники питания». Мы предлагаем Вам помощь Конструкторского отдела:

- Подбор оптимального решения, техническое обоснование при выборе компонента;
- Подбор аналогов;
- Консультации по применению компонента;
- Поставка образцов и прототипов;
- Техническая поддержка проекта;
- Защита от снятия компонента с производства.



#### Как с нами связаться

**Телефон:** 8 (812) 309 58 32 (многоканальный)

**Факс:** 8 (812) 320-02-42

**Электронная почта:** [org@eplast1.ru](mailto:org@eplast1.ru)

**Адрес:** 198099, г. Санкт-Петербург, ул. Калинина, дом 2, корпус 4, литера А.