

DC-DC Converter Application Manual

MPDTH12040W**

50A, 12V Input Non-Isolated Wide-Output Adjust Power Module



NOMINAL SIZE = 52mm x 26.7 mm

Features

- 50-A Output Current
- 8-V to 14V Input Voltage
- Wide-Output Voltage Adjust (0.8 V to 5.5 V)
- Efficiencies up to 96 %
- On/Off Inhibit
- Differential Output Sense
- Output Over-current Protection (Non-latching, Auto-Reset)
- Over-temperature Protection
- Auto-Track™ Sequencing
- Start Up Into Output Pre-bias
- Margin Up/Down Controls
- Operating Temp: -40 to +85 °C
- Multi-Phase, Switch-Mode Topology
- Programmable Under-voltage Lockout (UVLO)
- Safety Agency Approvals :
UL/cUL 60950, EN60950, VDE

Description

The MPDTH12040W is a high-performance 50-A rated, non-isolated, power module, which uses the latest multiphase switched-mode topology.

This provides a small, ready-to-use module, that can power the most densely populated multiprocessor systems.

Operating from an input voltage range of 8 V to 14 V, the MPDTH12040W requires a single resistor to set the output voltage to any value over the range, 0.8 V to 5.5 V. The wide input voltage range makes the MPDTH12040W particularly suitable for advanced computing and server applications that utilize a loosely regulated 12-V intermediate distribution bus. The modules incorporate a comprehensive list of features.

They include on/off inhibit and margin up/down controls.

A differential remote output voltage sense ensures tight load regulation, and an output over-current and over-temperature shutdown protect against most load faults. The programmable under-voltage lockout allows the turn-on and turn-off voltage thresholds to be customized. The MPDTH12040W incorporates Auto-Track™. The Auto-Track feature of the MPDTH family allows the outputs of multiple modules to track a common voltage during power up and power down transitions. This simplifies power up and power down supply-voltage sequencing in a power supply system. The modules use double-sided surface mount construction to provide a low profile and compact footprint. Package options include both through-hole and surface mount configurations.

Pin Configuration

Pin	Function
1	GND
2	Vin
3	GND
4	Vin
5	GND
6	Vin
7	Inhibit
8	UVLO Prog
9	Vout
10	GND
11	+Sense
12	Vout
13	GND
14	-Sense
15	Vout
16	GND
17	Vo Adjust
18	Track
19	Margin Up
20	Margin Down

Standard Application

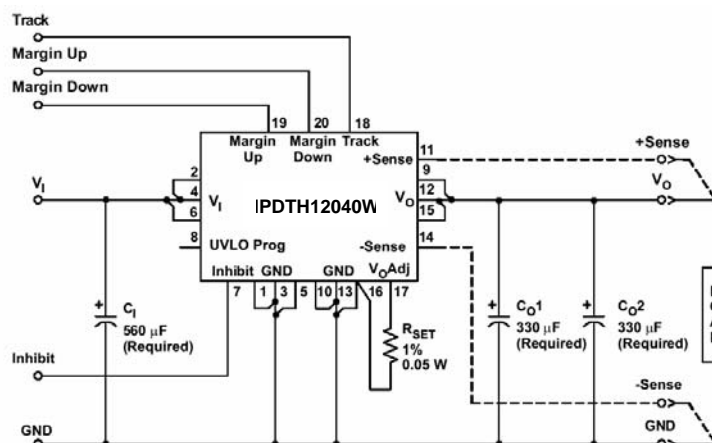

A. RSET = Required to set the output voltage higher than the minimum value (see the electrical characteristics for values.)

B. C1 = Required 560µF electrolytic capacitor. 1000µF recommended.

C. CO = Required 660µF (or 680µF) electrolytic capacitor.

⚠ Note:

1. This datasheet is downloaded from the website of Murata Manufacturing co., Ltd. Therefore, it's specifications are subject to change or our products in it may be discontinued without advance notice. Please check with our sales representatives or product engineers before ordering.
2. This datasheet has only typical specifications because there is no space for detailed specifications. Therefore, please approve our product specifications or transact the approval sheet for product specifications before ordering.

Ordering Information

Output Voltage (MPDTH12040□□xx)

Code	Voltage
W	0.8V-5.5V(Adjustable)

Package Options (MPDTH12040x□□□)

Code	Description
AH	Horiz. T/H
AS	SMD(*1)

Notes (1) Pb free (Sn-Ag-Cu) pin solder material.

Pin Description

GND: The common ground connection for the VI and VO power connections. It is also the 0 Vdc reference for the control inputs.

Vin: The positive input voltage power node to the module, which is referenced to common GND.

Vout: The regulated positive power output with respect to the GND node.

Inhibit ⁽¹⁾: The Inhibit pin is an open-collector/drain negative logic input that is referenced to GND. Applying a low level ground signal to this input disables the module's output and turns off the output voltage. When the Inhibit control is active, the input current drawn by the regulator is significantly reduced. If the Inhibit pin is left open-circuit, the module produces an output whenever a valid input source is applied.

Vo Adjust: A 1%, 0.05-W resistor must be connected between this pin and GND to set the output voltage higher than the minimum value. The set-point range for the output voltage is from 0.8 V to 5.5 V. The resistor required for a given output voltage may be calculated from the following formula. If left open circuit, the module output defaults to its lowest output voltage value. For further information on the adjustment and/or trimming of the output voltage, see the related Application Information section.

$$R_{set} = 10 \text{ k}\Omega \times \frac{0.8\text{V}}{V_{out}-0.8} - 1.696 \text{ k}\Omega$$

The specification table gives the preferred resistor values for a number of standard output voltages.

+Sense: The sense inputs allow the regulation circuit to compensate for voltage drop between the module and the load. For optimal voltage accuracy, +Sense should be connected to VO. If it is left open, a low-value internal resistor ensures that the output remains in regulation.

-Sense: For optimal voltage accuracy, -Sense should be connected to the ground return at the load. If it is left open, a low-value internal resistor ensures that the output remains in regulation.

UVLO Prog: Connecting a resistor from this pin to signal ground allows the *on* threshold of the input under-voltage lockout (UVLO) to be adjusted higher than the default value. The hysteresis can also be independently reduced by connecting a second resistor from this pin to Vin. For further information, see the Application Information section.

Track: This is an analog control input that allows the output voltage to follow another voltage during power up and power down sequences. The pin is active from 0 V, up to the nominal set-point voltage. Within this range, the module output follows the voltage at the Track pin on a volt-for-volt basis. When the control voltage is raised above this range, the module regulates at its nominal output voltage. If unused, this input should be connected to Vin for a faster power up. For further information, see the Application Information section.

Margin Down ⁽¹⁾: When this input is asserted to GND, the output voltage is decreased by 5% from the nominal. The input requires an open-collector (open-drain) interface. It is not TTL compatible. A lower percent change can be accommodated with a series resistor. For further information, see the Application Information section.

Margin Up ⁽¹⁾: When this input is asserted to GND, the output voltage is increased by 5%. The input requires an open collector (open-drain) interface. It is not TTL compatible. The percent change can be reduced with a series resistor. For further information, see the Application Information section.

(1) Denotes negative logic: Open = Normal operation /
Ground = Function active

⚠ Note:

1. This datasheet is downloaded from the website of Murata Manufacturing co., ltd. Therefore, it's specifications are subject to change or our products in it may be discontinued without advance notice. Please check with our sales representatives or product engineers before ordering.
2. This datasheet has only typical specifications because there is no space for detailed specifications. Therefore, please approve our product specifications or transact the approval sheet for product specifications before ordering.

Environmental & Absolute Maximum Ratings (Voltages are with respect to GND)

Characteristics	Symbols	Conditions	Min	Typ	Max	Units
Track Input Voltage	V _{track}		-0.3	-	V _{in} +0.3	V
Operating Temperature Range	T _a	Over V _{in} Range	-40	-	85	°C
Storage Temperature	T _s	-	-40		125	°C
Solder Reflow Temperature	T _{reflow}	Surface temperature of module body or pins			245(i)	°C

Notes: (i) During reflow of SMD package version do not elevate peak temperature of the module, pins or internal components above the stated maximum.

Specifications (Unless otherwise stated, T_a =25 °C, V_{in} =12 V, V_{out} =3.3 V, C_{in} =1000 μF, C_{out} =660 μF, and I_o =I_{omax})

Characteristics	Symbols	Conditions	MPDTH12040W			Units	
			Min	Typ	Max		
Output Current	I _o	60°C 200LFM airflow	0	-	50 (1)	A	
Input Voltage Range	V _{in}	Over I _o range	8 (2)	-	14	V	
Set-Point Voltage Tolerance	V _{o tol}		-	-	±2 (3)	%V _o	
Temperature Variation	ΔRegtemp	-40 °C <T _a < +85 °C	-	±0.5	-	%V _o	
Line Regulation	ΔRegline	Over V _{in} range	-	±5	-	mV	
Load Regulation	ΔRegload	Over I _o range	-	±5	-	mV	
Total Output Variation	ΔRegtot	Includes set-point, line, load, -40 °C ≤T _a ≤+85 °C	-	-	±3 (2)	%V _o	
Output adjust range	ΔRegadj		0.8	-	5.5 (3)	V	
Efficiency	η	I _o =35A	RSET = 205Ω V _o = 5.0 V	-	96	-	%
		RSET = 1.5 kΩ V _o = 3.3 V	-	95	-		
		RSET = 3.01 kΩ V _o = 2.5 V	-	93	-		
		RSET = 4.99kΩ V _o = 2.0 V	-	92	-		
		RSET =6.34 kΩ V _o = 1.8 V	-	91	-		
		RSET = 9.76 kΩ V _o = 1.5 V	-	90	-		
		RSET = 18.2 kΩ V _o = 1.2 V	-	88	-		
		RSET = 38.3 kΩ V _o = 1.0 V	-	86	-		
RSET = open circuit, V _o = 0.8 V	-	82	-				
Vo Ripple (pk-pk)	V _r	20 MHz bandwidth All voltages	-	15	-	mVpp	
Over-current threshold	I _{o trip}	Reset, followed by auto-recovery	-	95	-	A	
Transient Response	t _{tr}	1A/μs load step, 50to100% I _{omax} C _{out} =660 μF	Recovery Time	-	70	-	μsec
	ΔV _{tr}		Voover/undershoot	-	150	-	mV
Margin Up/Down Adjust	ΔV _{omargin}	With Margin up/down control	-	±5	-	%	
Margin Input Current	I _{IL margin}	Pin to GND	-	-8(4)	-	μA	
Track Input Current (pin 18)	I _{IL track}	Pin to GND	-	-	-0.10 (5)	mA	
Track Slew Rate Capability	dV _{track} /dt	V _{TRACK} - V _o ≤ 50 mV and V _{TRACK} < V _o (nom)	-	-	1	V/ms	
Under-voltage lockout	UVLO	Pin 8 open	On-threshold	-	7.5(6)	-	V
			Hysteresis	-	1 (6)	-	V
Inhibit Control (pin7) Voltage	Hi	V _{IH}	Referenced to GND	2.5	-	Open(7)	V
	Lo	V _{IL}		-0.2	-	0.5	V
Input Low Current	I _{ILinhibit}	Pin to GND	-	0.5	-	mA	
Input Standby Current	I _{lin inh}	Inhibit (pin 7) to GND	-	35	-	mA	
Switching Frequency	F _{rq}	Over V _{in} and I _o ranges	0.9	1.05	1.2	MHz	
External Input Capacitance	C _{in}		560 (8)	1000	-	μF	
External Output Capacitance	C _{out}	Capacitance value	non-ceramic	660 (9)	-	14000(10)	μF
			ceramic	-	-	400	
		Equivalent series resistance (non-ceramic)	2 (11)	-	-	mΩ	
MTBF	MTBF	Per Bellcore TR-332 50 % stress, T _a =40 °C, ground benign	2.5	-	-	10 ⁶ Hrs	

(1) See SOA curves or consult factory for appropriate derating.

(2) The set-point voltage tolerance is affected by the tolerance of RSET. The stated limit is unconditionally met if RSET has a tolerance of 1% with 100ppm/°C or better temperature stability.

(3) When the set-point voltage is adjusted higher than 3.6 V, a 10-V minimum input voltage is recommended.

(4) A small, low-leakage (<100 nA) MOSFET is recommended to control this pin. The open-circuit voltage is less than 1 Vdc.

(5) This control pin has an internal pull-up to 6.7 V. If left open-circuit, the module operates when input power is applied. A small, low leakage (<100 nA) MOSFET or open-drain/collector voltage supervisor IC is recommended for control. See the *Application Information* section for further guidance.

(6) Default voltages may be adjusted using the UVLO Prog control input. See the *Application Information* section for further guidance.

(7) This control pin has an internal pull-up to 5 V nominal. If it is left open-circuit, the module operates when input power is applied. A small,

(8) Low-leakage (<100 nA) MOSFET is recommended for control. For further information, see the related application note. A minimum capacitance of 560-μF is required at the input for proper operation. For best results, 1000μF is recommended. The capacitance must be rated for a minimum of 300 mArms of ripple current.

(9) A minimum value of output capacitance is required for proper operation. Adding additional capacitance at the load further improves transient response.

(10) This is the calculated maximum. The minimum ESR requirement often results in a lower value. See the *Application Information* section for further guidance.

(11) This is the typical ESR for all the electrolytic (non-ceramic) output capacitance. Use 4 mΩ as the minimum when using max-ESR values to calculate.

⚠ Note:

- This datasheet is downloaded from the website of Murata Manufacturing co., Ltd. Therefore, it's specifications are subject to change or our products in it may be discontinued without advance notice. Please check with our sales representatives or product engineers before ordering.
- This datasheet has only typical specifications because there is no space for detailed specifications. Therefore, please approve our product specifications or transact the approval sheet for product specifications before ordering.

Characteristic Data; Vin =12 V

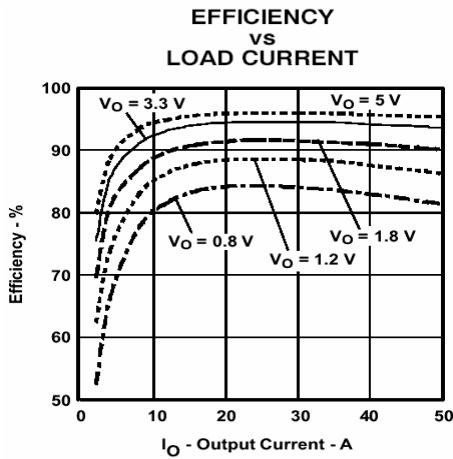

Figure 1

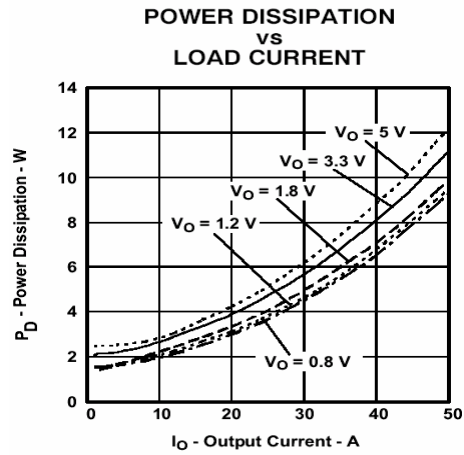

Figure 2

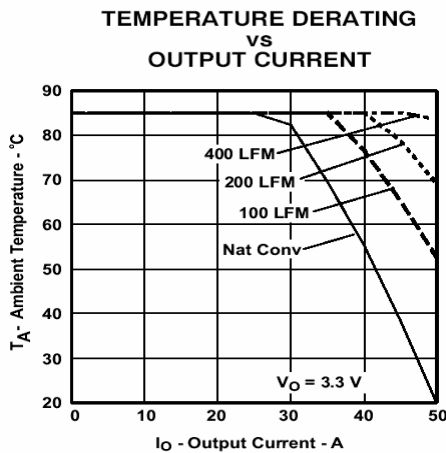

Figure 3

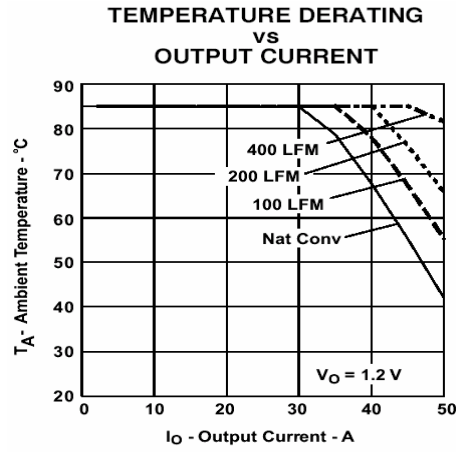

Figure 4

- (1) The electrical characteristic data has been developed from actual products tested at 25°C. This data is considered typical for the converter. Applies to [Figure 1](#) and [Figure 2](#).
- (2) The temperature derating curves represent the conditions at which internal components are at or below the manufacturer's maximum operating temperatures. Derating limits apply to modules soldered directly to a 4-mm x 4-mm, double-sided PCB with 1-oz. copper. For surface mount packages (AS and AZ suffix), multiple vias (plated through holes) are required to add thermal paths around the power pins. Please refer to the mechanical specification for more information. Applies to [Figure 3](#) and [Figure 4](#).

Characteristic Data; Vin =8 V

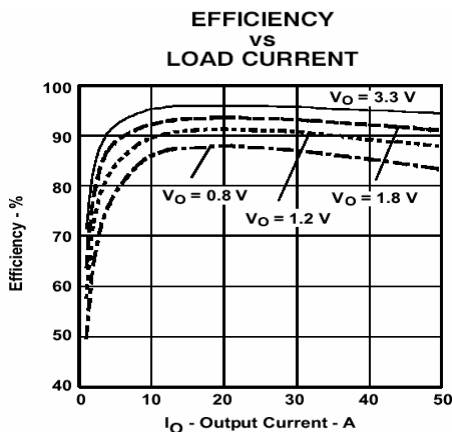

Figure 5

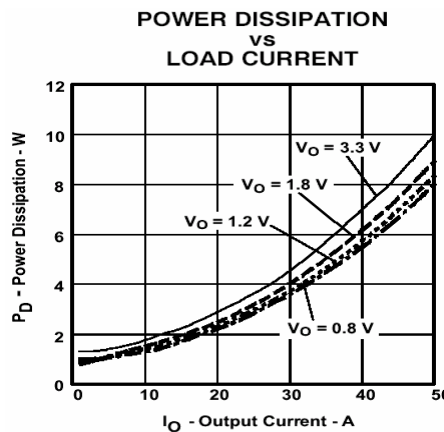

Figure 6

- (3) The electrical characteristic data has been developed from actual products tested at 25°C. This data is considered typical for the converter. Applies to [Figure 5](#) , and [Figure 6](#).

⚠ Note:

1. This datasheet is downloaded from the website of Murata Manufacturing co., ltd. Therefore, it's specifications are subject to change or our products in it may be discontinued without advance notice. Please check with our sales representatives or product engineers before ordering.
2. This datasheet has only typical specifications because there is no space for detailed specifications. Therefore, please approve our product specifications or transact the approval sheet for product specifications before ordering.

Capacitor Recommendations for the MPDTH12040W Power Modules

The MPDTH12040W is a state-of-the-art multi-phase power converter topology that uses three parallel switching and filter inductor paths between the common input and output filter capacitors. The three paths share the load current, operate at the same frequency, and are evenly displaced in phase. With multiple switching paths the transient output current capability is significantly increased. This reduces the amount of external output capacitance required to support a load transient. As a further benefit, the ripple current, as seen by the input and output capacitors, is reduced in magnitude and effectively tripled in frequency.

Input Capacitor

The improved transient response of a multi-phase converter places a bigger burden on the transient capability of the input source. The size and value of the input capacitor is therefore determined by this converter's transient performance capability. The minimum amount of input capacitance required is 560 μF , with an RMS ripple current rating of 300 mA. This minimum value assumes that the converter is supplied with a responsive, low inductance input source. This source should have ample capacitive decoupling, and be distributed to the converter via PCB power and ground planes. For high-performance applications, or wherever the transient performance of the input source is limited, 1000 μF of input capacitance is recommended. Ripple current, less than 100 m Ω of equivalent series resistance (ESR), and temperature are the main considerations when selecting input capacitors. The ripple current reflected from the input of the MPDTH12040W module is moderate to low. Therefore any good quality, computer-grade electrolytic capacitor, of either value suggested, has an adequate ripple current rating. Regular tantalum capacitors are not recommended for the input bus. These capacitors require a recommended minimum voltage rating of $2 \times$ (maximum dc voltage + ac ripple). This is standard practice to ensure reliability. No tantalum capacitors were found with a sufficient voltage rating to meet this requirement. When the operating temperature is below 0°C, the ESR of aluminum electrolytic capacitors increases. For these applications, Os-Con, poly-aluminum, and polymer-tantalum types should be considered. Adding one or two ceramic capacitors to the input reduces high-frequency reflected ripple current.

Output Capacitors

The MPDTH12040W requires a minimum output capacitance of 660 μF (or $2 \times 330 \mu\text{F}$), with an ESR of 15 m Ω to 40 m Ω . This is necessary for the stable operation of the regulator. Additional capacitance can be added to improve the module's performance to load transients. High quality computer-grade electrolytic capacitors are recommended. Aluminum electrolytic capacitors provide adequate decoupling over the frequency range, 2 kHz to 150 kHz, and are suitable when ambient temperatures are above 0°C. For operation below 0°C, tantalum, ceramic, or Os-Con type capacitors are necessary. When using a combination of one or more non-ceramic capacitors, the calculated equivalent ESR should be no lower than 2 m Ω (4 m Ω when calculating using the manufacturer's maximum ESR values). A list of preferred low-ESR type capacitors are identified in [Table 1](#).

⚠ Note:

1. This datasheet is downloaded from the website of Murata Manufacturing co., Ltd. Therefore, it's specifications are subject to change or our products in it may be discontinued without advance notice. Please check with our sales representatives or product engineers before ordering.
2. This datasheet has only typical specifications because there is no space for detailed specifications. Therefore, please approve our product specifications or transact the approval sheet for product specifications before ordering.

Ceramic Capacitors

Above 150 kHz the performance of aluminum electrolytic capacitors is less effective. Multilayer ceramic capacitors have very low ESR and a resonant frequency higher than the bandwidth of the regulator. They can be used to reduce the reflected ripple current at the input as well as improve the transient response of the output.

When used on the output their combined ESR is not critical as long as the total value of ceramic capacitors, with values between 10 μF and 100 μF , does not exceed 400 μF . Also, to prevent the formation of local resonances, do not place more than five identical ceramic capacitors in parallel with values of 10 μF or greater.

Tantalum Capacitors

Tantalum type capacitors are only used on the output bus, and are recommended for applications where the ambient operating temperature is less than 0°C. The AVX TPS, Sprague 593D/594/595 and Kemet T495/T510 capacitor series are suggested over many other tantalum types due to their higher rated surge, power dissipation, and ripple current capability. As a caution, many general purpose tantalum capacitors have higher ESR, reduced power dissipation, and lower ripple current capability. These capacitors are also less reliable due to their reduced power dissipation and surge current ratings. Tantalum capacitors that have no stated ESR or surge current rating are not recommended for power applications.

When specifying Os-con and polymer-tantalum capacitors for the output, the minimum ESR limit is encountered well before the maximum capacitance value is reached.

Capacitor Table

[Table 1](#) identifies the characteristics of capacitors from a number of vendors with acceptable ESR and ripple current (rms) ratings. The recommended number of capacitors required at both the input and output buses is identified for each capacitor type.

Note: This is not an extensive capacitor list. Capacitors from other vendors are available with comparable specifications. Those listed are for guidance. The RMS ripple current rating and ESR (at 100 kHz) are critical parameters necessary to insure both optimum regulator performance and long capacitor life.

Designing for Very Fast Load Transients

The transient response of the dc/dc converter has been characterized using a load transient with a di/dt of 1 A/ μs . The typical voltage deviation for this load transient is given in the data sheet specification table using the minimum required value of output capacitance. As the di/dt of a transient is increased, the response of a converter's regulation circuit ultimately depends on its output capacitor decoupling network. This is an inherent limitation with any dc/dc converter once the speed of the transient exceeds its bandwidth capability. If the target application specifies a higher di/dt or lower voltage deviation, the requirement can only be met with additional output capacitor decoupling. In these cases special attention must be paid to the type, value and ESR of the capacitors selected.

Table 1; Input / Output Capacitors

Capacitor Vendor, Type Series (Style)	Capacitor Characteristics					Quantity		Vendor Number
	Working Voltage	Value (μF)	MAX.(ESR) at 100kHz	Max.Ripple at 85°C Current(Irms)	Physical Size(mm)	Input Bus	Output Bus	
Panasonic FC (Radial)	25V	1000	0.043Ω	>1690 mA	16×15	1	1	EEUFC1E102S
	25V	560	0.065Ω	1205 mA	12.5×15	1	2	EEUFC1E561S
	16V	680	0.080Ω	>850 mA	10×10.2	1	1	EEVFK1C681P
FK (SMD)	35V	1000	0.060Ω	1100 mA	12.5×13.5	1	1	EEVFK1V102Q
United Chemi-Con MVZ(SMD)	16V	470	0.090Ω	670 mA	10×10	2	2	MVZ25VC471MJ10TP
LXZ, Aluminum (Radial)	16V	470	0.090Ω	760 mA	10×12.5	2	2	LXZ16VB471M10X12LL
PS, Poly- Aluminum(Radial)	25V	680	0.068Ω	1050 mA	10×16	1	1	LXZ16VB681M10X16LL
PXA, Poly- Aluminum(SMD)	16V	330	0.014Ω	5060 mA	10×12.5	2	≤4	16PS330MJ12
	16V	330	0.014Ω	5050 mA	10×12.2	2	≤4	PXA16VC331MJ12TP
Nichicon, Aluminum HD, (Radial)	25V	560	0.060Ω	1060 mA	12.5×15	1	2	UPM1E561MHH6
PM, (Radial)	25V	680	0.038Ω	1430 mA	10×16	1	1	UHD1C681MHR
	35V	560	0.048Ω	1360 mA	16×15	1	2	UPM1V561MHH6
Panasonic, Poly-Aluminum: SP-Cap	6.3V	180	0.005Ω	4100mA	7.3×5.7	N/R[2]	≤5	EEFSE09J181R (Vo≤5.1V)
Sanyo TPE, Poscap(SMD)	10V							
SP, Os-Con(Radial)	16V	330	0.025Ω	3000 mA	7.3×5.7	N/R[2]	≤5	10TPE330M
SVP, Os-Con (SMD)	16V	470	0.010Ω	>6000 mA	10×13	3[3]	≤4	16SEPC470M
		330	0.016Ω	4700 mA	11×12	2	≤4	6SVP330M
AVX, Tantalum, Series □	10V	470	0.045Ω	>1723 mA	7.3×5.7×4.1	N/R[2]	≤5[4]	TPSE477M010R0045 (Vo≤5.1V)
TPS (SMD)	10V	330	0.045Ω	1723 mA		N/R[2]	≤5[4]	TPSE337M010R0045 (Vo≤5.1V)
Kemet, Poly-Tantalum T520(SMD)	10V	330	0.040Ω	1800 mA	4.3×7.3×4.0	N/R[2]	2	T520X337M010AS
T530 (SMD)(Poly-Tantalum)	10V	330	0.015Ω	>3800 mA		N/R[2]	≤4	T530X337M010AS
	6.3V	470	0.012Ω	4200 mA		N/R[2]	≤3[4]	T530X477M006AS (Vo≤5.1V)
T530 (SMD)(Poly-Tantalum)	4V	680	0.005Ω	>5000 mA	4.3×4.3×4.0	N/R[2]	≤2	T530X687M004ASE005 (Vo≤3.2V)
Vishay-Sprague 595D, Tantalum(SMD)	10V	470	0.100Ω	1440 mA	7.2×6×4.1	N/R[2]	2[4]	595D477X0010R2T (Vo≤5.1V)
94SA, Os-con(Radial)	16V	1000	0.015Ω	9740 mA	16×25	1	≤4	94SA108X0016HBP
Kemet, Ceramic X5R(SMD)	16V	10	0.002Ω	-	3225mm	1[5]	≤8	C1210C106M4PAC
	6.3V	47	0.002Ω	-		N/R[2]	≤8	C1210C476K9PAC
Murata, Ceramic X5R(SMD)	6.3V	100	-	-		N/R[2]	≤4	GRM32ER60J107M
	6.3V	47				N/R[2]	≤8	GRM32ER60J476M
	16V	47			3225mm	1[5]	≤8	GRM32ER61C476K
	16V	22				1[5]	≤8	GRM32ER61C226K
	16V	10				1[5]	≤8	GRM32DR61C106K
TDK, Ceramic X5R(SMD)	6.3V	100	-	-		N/R[2]	≤4	C3225X5R0J107MT
	6.3V	47			3225mm	N/R[2]	≤8	C3225X5R0J476MT
	16V	22				1[5]	≤8	C3225X5R1C226MT
	16V	10				1[5]	≤8	C3225X5R1C106MT

(1) Capacitor Supplier Verification

Please verify availability of capacitors identified in this table. Capacitor suppliers may recommend alternative part numbers because of limited availability or obsolete products. In some instances, the capacitor product life cycle may be in decline and have short-term consideration for obsolescence.

RoHS, Lead-free and Material Details

Please consult capacitor suppliers regarding material composition, RoHS status, lead-free status, and manufacturing process requirements. Component designators or part number deviations can occur when material composition or soldering requirements are updated.

- (2) N/R – Not recommended. The voltage rating does not meet the minimum operating limits.
- (3) Total capacitance of 540 μF is acceptable based on the combined ripple current rating.
- (4) The voltage rating of this capacitor only allows it to be used for output voltages that are equal to or less than 5.1 V.
- (5) Small ceramic capacitors may be used to complement electrolytic types at the input to further reduce high-frequency ripple current.

⚠ Note:

1. This datasheet is downloaded from the website of Murata Manufacturing co., ltd. Therefore, it's specifications are subject to change or our products in it may be discontinued without advance notice. Please check with our sales representatives or product engineers before ordering.
2. This datasheet has only typical specifications because there is no space for detailed specifications. Therefore, please approve our product specifications or transact the approval sheet for product specifications before ordering.

Adjustment of the Output Voltage of the MPDTH12040W Wide-Output Adjust Power Modules

The VO Adjust control (pin 17) sets the output voltage of the MPDTH12040W product. The adjustment range is from 0.8 V to 5.5 V. The adjustment method requires the addition of a single external resistor, R_{SET}, that must be connected directly between the VO Adjust and GND pins 1. Table 2 gives the preferred value of the external resistor for a number of standard voltages, along with the actual output voltage that this resistance value provides. Figure 7 shows the placement of the required resistor.

For other output voltages, the value of the required resistor can either be calculated, or simply selected from the range of values given in Table 3. The following formula can be used to calculate the adjust resistor value.

$$R_{set} = 10 \text{ k}\Omega \times \frac{0.8\text{V}}{V_{out}-0.8\text{V}} - 1.696 \text{ k}\Omega \quad (1)$$

Table 2; Standard Values of Rset for Common Output Voltages

Vout(Required)	Rset	Vout(Actual)
5V	2.5 Ω	5.008V
3.3V	1.5k Ω	3.303V
2.5V	3.01k Ω	2.5V
2V	4.99k Ω	1.997V
1.8V	6.34k Ω	1.796V
1.5V	9.76k Ω	1.498V
1.2V	18.2k Ω	1.202V
1V	38.3k Ω	1V
0.8V	Open	0.8V

Figure 7: Vo Adjust Resistor Placement

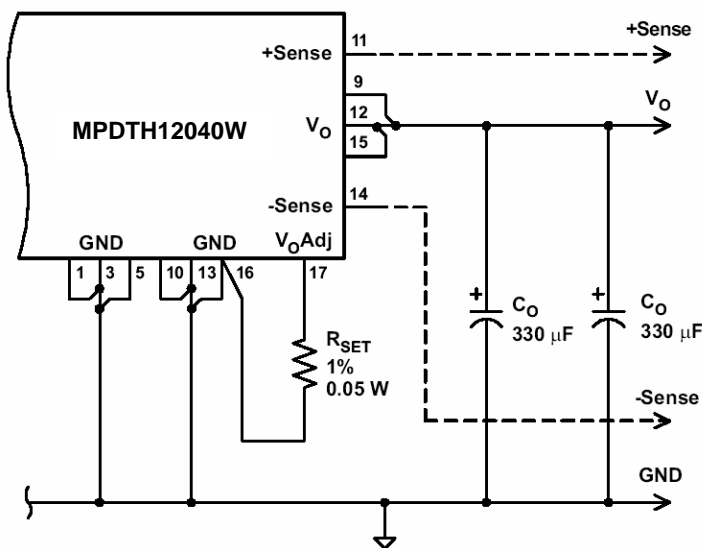

- (1) A 0.05-W rated resistor may be used. The tolerance should be 1%, and the temperature stability, 100 ppm/°C (or better). Place the resistor as close to the regulator as possible. Connect the resistor directly between pin 17 and nearest GND pin (pin 16) using dedicated PCB traces.
- (2) Never connect capacitors from Vo Adjust to either GND or VO. Any capacitance added to the Vo Adjust pin affects the stability of the regulator.

⚠ Note:

1. This datasheet is downloaded from the website of Murata Manufacturing co., Ltd. Therefore, it's specifications are subject to change or our products in it may be discontinued without advance notice. Please check with our sales representatives or product engineers before ordering.
2. This datasheet has only typical specifications because there is no space for detailed specifications. Therefore, please approve our product specifications or transact the approval sheet for product specifications before ordering.

Table 3: Output Voltage Set-Point Resistor Values

Vo	Rset	Vo	Rset	Vo	Rset
0.800	Open	1.60	8.3 kΩ	3.05	1.86 kΩ
0.825	318 kΩ	1.65	7.72 kΩ	3.10	1.78 kΩ
0.850	158 kΩ	1.70	7.19 kΩ	3.15	1.71 kΩ
0.875	105 kΩ	1.75	6.73 kΩ	3.20	1.64 kΩ
0.900	78.31 kΩ	1.80	6.3 kΩ	3.25	1.57 kΩ
0.925	62.3 kΩ	1.85	5.92 kΩ	3.30	1.5 kΩ
0.950	51.6 kΩ	1.90	5.58 kΩ	3.35	1.44 kΩ
0.975	44 kΩ	1.95	5.26 kΩ	3.40	1.38 kΩ
1.000	38.3 kΩ	2.00	4.97 kΩ	3.50	1.27 kΩ
1.025	33.9 kΩ	2.05	4.7 kΩ	3.60	1.16 kΩ
1.050	30.3 kΩ	2.10	4.46 kΩ	3.70	1.06 kΩ
1.075	27.4 kΩ	2.15	4.23 kΩ	3.80	971 Ω
1.100	25 kΩ	2.20	4.02 kΩ	3.90	885 Ω
1.125	22.9 kΩ	2.25	3.82 kΩ	4.00	804 Ω
1.150	21.2 kΩ	2.30	3.64 kΩ	4.10	728 Ω
1.175	19.6 kΩ	2.35	3.47 kΩ	4.20	657 Ω
1.200	18.3 kΩ	2.40	3.3 kΩ	4.30	590 Ω
1.225	17.1 kΩ	2.45	3.15 kΩ	4.40	526 Ω
1.250	16.1 kΩ	2.50	3.01 kΩ	4.50	466 Ω
1.275	15.1 kΩ	2.55	2.88 kΩ	4.60	409 Ω
1.300	14.3 kΩ	2.60	2.75 kΩ	4.70	355 Ω
1.325	13.5 kΩ	2.65	2.63 kΩ	4.80	304 Ω
1.350	12.8 kΩ	2.70	2.51 kΩ	4.90	255 Ω
1.375	12.2 kΩ	2.75	2.41 kΩ	5.00	209 Ω
1.400	11.6 kΩ	2.80	2.3 kΩ	5.10	164 Ω
1.425	11.1 kΩ	2.85	2.21 kΩ	5.20	122 Ω
1.450	10.6 kΩ	2.90	2.11 kΩ	5.30	82 Ω
1.475	10.2 kΩ	2.95	2.02 kΩ	5.40	43 Ω
1.50	9.73 kΩ	3.00	1.94 kΩ	5.50	0 Ω
1.55	8.97 kΩ				

Adjusting the Under-voltage Lockout(UVLO) of the MPDTH12040W Power Modules

The MPDTH12040W power modules incorporate an input under-voltage lockout (UVLO). The UVLO feature prevents the operation of the module until there is sufficient input voltage to produce a valid output voltage. This enables the module to provide a clean, monotonic power-up for the load circuit, and also limits the magnitude of current drawn from the regulator's input source during the power-up sequence.

The UVLO characteristic is defined by the on-threshold (V_{THD}) and hysteresis (V_{HYS}) voltages. Below the *on* threshold, the Inhibit control is overridden, and the module does not produce an output. The hysteresis voltage is the difference between the *on* and *off* threshold voltages. It ensures a clean power-up, even when the input voltage is rising slowly. The hysteresis prevents start-up oscillations, which can occur if the input voltage droops slightly when the module begins drawing current from the input source.

⚠ Note:

1. This datasheet is downloaded from the website of Murata Manufacturing co., Ltd. Therefore, it's specifications are subject to change or our products in it may be discontinued without advance notice. Please check with our sales representatives or product engineers before ordering.
2. This datasheet has only typical specifications because there is no space for detailed specifications. Therefore, please approve our product specifications or transact the approval sheet for product specifications before ordering.

UVLO Adjustment

The UVLO feature of the MPDTH12040W module allows for limited adjustment of both the on threshold and hysteresis voltages. The adjustment is made via the *UVLO Prog* control pin. When the UVLO Prog pin is left open circuit, the on threshold and hysteresis voltages are internally set to their default values. The *on* threshold has a nominal voltage of 7.5 V, and the hysteresis 1 V. This ensures that the module produces a regulated output when the minimum input voltage is applied (see specifications). The combination correlates to an *off* threshold of approximately 6.5 V. The adjustments are limited. The on threshold can only be adjusted higher, and the hysteresis voltage can only be reduced in magnitude.

The *on* threshold might need to be raised if the module is powered from a tightly regulated 12-V bus. This would prevent it from operating if the input bus failed to completely rise to its specified regulation voltage. The hysteresis should not be changed unless absolutely necessary. A generous amount of hysteresis ensures that the module exhibits a clean startup. Therefore, adjustment of the hysteresis should only be considered if there is a system requirement to specifically set the off threshold voltage (in addition to the on threshold). Depending on the load regulation of the input source, the hysteresis should not be adjusted below 0.5 V without careful consideration.

Adjustment Method

The resistors, R_{THD} and R_{HYS} (see Figure 8), provide the adjustment of the on-threshold and hysteresis voltages.

R_{THD} connects between the UVLO Prog control pin and GND, and R_{HYS} is connected between the UVLO Prog and V_I . R_{THD} alone is used to adjust the on-threshold voltage higher. However, to adjust the hysteresis to a lower value requires both the R_{HYS} and R_{THD} resistors to be placed in the circuit. The recommended adjustment method requires that any change to the hysteresis be determined first. If the hysteresis is changed, then a value for R_{THD} must also be calculated. This is irrespective of whether a change is required to the value of V_{THD} . If there is no change to V_{HYS} , then a resistor should not be placed in the R_{HYS} location. R_{HYS} should then be assigned an infinite value for calculating the value of R_{THD} .

Figure 8: UVLO Program Resistor Placement

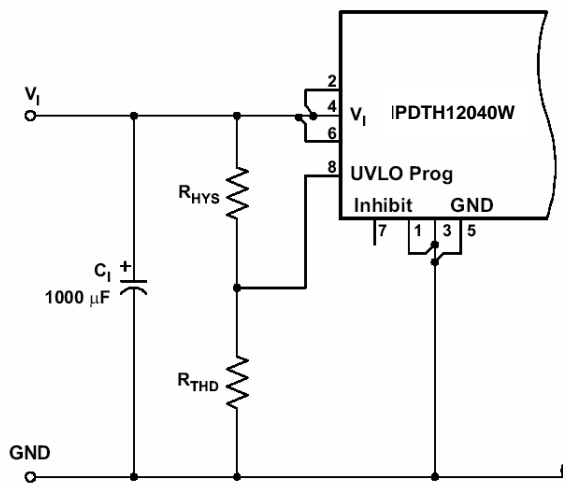

Hysteresis Adjust

The hysteresis voltage, V_{HYS} , is the difference between the *on* and *off* threshold values. The default value is 1 V and it can only be adjusted to a lower value.

Caution should be used when changing the hysteresis voltage to a lower value, as it could induce start-up oscillations.

Any change in the hysteresis voltage requires both R_{HYS} and R_{THD} resistors be in place. Adding R_{HYS} alone does not have the desired effect. The value for R_{HYS} must first be calculated using Equation 2. The value identified for R_{HYS} must then be used to determine a value for R_{THD} , using Equation 3.

$$R_{HYS} = \frac{26.1 \times V_{HYS}}{0.365 \times (1 - V_{HYS})} \text{ k}\Omega \quad (2)$$

Threshold Adjust

Equation 3 determines the value of R_{THD} required to adjust V_{THD} to a new value. The default value is 7.5 V, and it may only be adjusted to a higher value. If the hysteresis value has been adjusted, then a value for R_{THD} must also be calculated. (This is irrespective of whether V_{THD} is being adjusted.) If there has been no adjustment for the hysteresis voltage, the term $1/R_{HYS}$ in Equation 3, may be assigned the value, 0.

$$R_{THD} = \frac{39.2 \text{ k}\Omega}{39.2 \left[\left(\frac{1}{R_{HYS}} + 0.014 \right) \left(\frac{V_{THD}}{2.5} - 1 \right) - 0.0027 \right] - 1} \quad (3)$$

⚠ Note:

1. This datasheet is downloaded from the website of Murata Manufacturing Co., Ltd. Therefore, it's specifications are subject to change or our products in it may be discontinued without advance notice. Please check with our sales representatives or product engineers before ordering.
2. This datasheet has only typical specifications because there is no space for detailed specifications. Therefore, please approve our product specifications or transact the approval sheet for product specifications before ordering.

Calculated Values

Table 4 shows a matrix of standard resistor values for R_{HYS} and R_{THD} , for different options of the on-threshold (V_{THD}) and hysteresis (V_{HYS}) voltages. For most applications, only the on-threshold voltage should need to be adjusted. In this case select only a value for R_{THD} from far right-hand column.

The hysteresis should only be adjusted if there is a specific requirement to independently adjust the off-threshold, separately from the on-threshold voltage. In this case, a value for both R_{HYS} and R_{THD} must be selected from Table 4. This is irrespective of whether the on-threshold voltage is being adjusted.

Table 4: Calculated Values of R_{HYS} and R_{THD} , for Various Values of V_{HYS} and V_{THD}

	V_{HYS}	0.5V	0.6V	0.7V	0.8V	0.9V	1V (default)
V_{THD}	R_{HYS}	71.5k Ω	107k Ω	165k Ω	287k Ω	649k Ω	N/A
8V	R_{THD}	30.1k Ω	43.2k Ω	63.4k Ω	97.6k Ω	169k Ω	402k Ω
8.5V		25.5k Ω	36.5k Ω	51.1k Ω	73.2k Ω	110k Ω	187k Ω
9V		23.2k Ω	30.9k Ω	42.2k Ω	57.6k Ω	82.5k Ω	124k Ω
9.5V		20k Ω	27.4k Ω	36.5k Ω	48.7k Ω	64.9k Ω	90.9k Ω
10V		18.2k Ω	24.3k Ω	31.6k Ω	41.2k Ω	54.9k Ω	73.2k Ω
10.5V		16.2k Ω	21.5k Ω	28k Ω	36.5k Ω	46.4k Ω	60.4k Ω
11V		15k Ω	19.6k Ω	25.5k Ω	32.4k Ω	41.2k Ω	52.3k Ω
11.5V		14k Ω	18.2k Ω	23.2k Ω	28k Ω	36.5k Ω	45.3k Ω
12V		12.7k Ω	16.5k Ω	21k Ω	26.1k Ω	32.4k Ω	40.2k Ω

⚠ Note:

1. This datasheet is downloaded from the website of Murata Manufacturing co., ltd. Therefore, it's specifications are subject to change or our products in it may be discontinued without advance notice. Please check with our sales representatives or product engineers before ordering.
2. This datasheet has only typical specifications because there is no space for detailed specifications. Therefore, please approve our product specifications or transact the approval sheet for product specifications before ordering.

Features of the MPDTH Series of Non-Isolated Wide Output Adjust Power Modules

POLA™ Compatibility

The MPDTH family of nonisolated, wide-output adjustable power modules from Murata Manufacturing are optimized for applications that require a flexible, high performance module that is small in size. Each of these products are POLA™ compatible. POLA-compatible products are produced by a number of manufacturers, and offer customers advanced, non-isolated modules with the same footprint and form factor. POLA parts are also assured to be interoperable, thereby providing customers with second-source availability.

All POLA products include Auto-Track™. This feature was specifically designed to simplify the task of sequencing the supply voltages in a power system. This and other features are described in the following sections.

Soft-Start Power Up

The Auto-Track feature allows the power-up of multiple MPDTH modules to be directly controlled from the Track pin.

However in a stand-alone configuration, or when the Auto-Track feature is not being used, the Track pin should be directly connected to the input voltage, VI (see Figure 9).

Figure 9; Power-Up Application Circuit

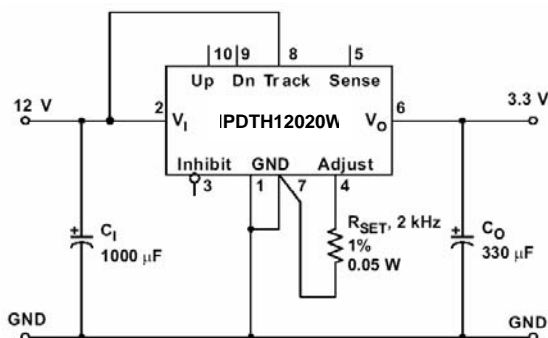

When the Track pin is connected to the input voltage the Auto-Track function is permanently disengaged. This allows the module to power up entirely under the control of its internal soft-start circuitry. When power up is under soft-start control, the output voltage rises to the set-point at a quicker and more linear rate.

From the moment a valid input voltage is applied, the soft-start control introduces a short time delay (typically 8 ms–15 ms) before allowing the output voltage to rise.

Figure 10; Power-Up Waveforms

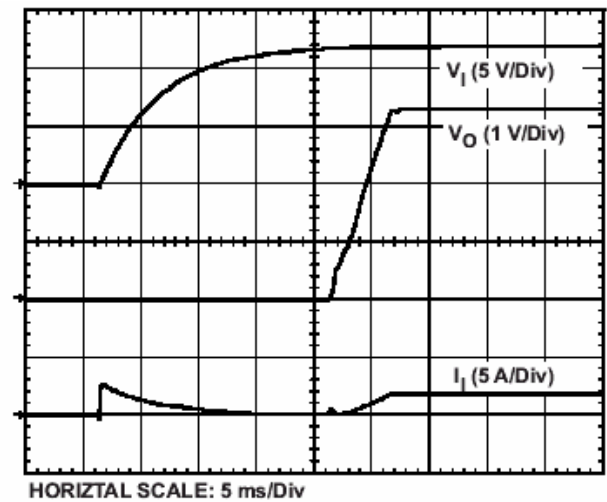

The output then progressively rises to the module's set-point voltage. Figure 10 shows the soft-start power-up characteristic of the 18-A output product (MPDTH12020W), operating from a 12-V input bus and configured for a 3.3-V output. The waveforms were measured with a 5-A resistive load and the Auto-Track feature disabled. The initial rise in input current when the input voltage first starts to rise is the charge current drawn by the input capacitors. Power-up is complete within 25 ms.

Over-Current Protection

For protection against load faults, all modules incorporate output over-current protection. Applying a load that exceeds the regulator's over-current threshold causes the regulated output to shut down. Following shutdown, a module periodically attempt to recover by initiating a soft-start power-up. This is described as a *hiccup* mode of operation, whereby the module continues in a cycle of successive shutdown and power up until the load fault is removed. During this period, the average current flowing into the fault is significantly reduced. Once the fault is removed, the module automatically recovers and returns to normal operation.

⚠ Note:

1. This datasheet is downloaded from the website of Murata Manufacturing co., Ltd. Therefore, it's specifications are subject to change or our products in it may be discontinued without advance notice. Please check with our sales representatives or product engineers before ordering.
2. This datasheet has only typical specifications because there is no space for detailed specifications. Therefore, please approve our product specifications or transact the approval sheet for product specifications before ordering.

Over-Temperature Protection (OTP)

The MPDTH12020, MPDTH12030, and MPDTH12040 products have over-temperature protection. These products have an on-board temperature sensor that protects the module's internal circuitry against excessively high temperatures.

A rise in the internal temperature may be the result of a drop in airflow, or a high ambient temperature. If the internal temperature exceeds the OTP threshold, the module's Inhibit control is internally pulled low. This turns the output off. The output voltage drops as the external output capacitors are discharged by the load circuit. The recovery is automatic, and begins with a soft-start power up. It occurs when the sensed temperature decreases by about 10°C below the trip point.

Note: The over-temperature protection is a last resort mechanism to prevent thermal stress to the regulator.

Operation at or close to the thermal shutdown temperature is not recommended and reduces the long-term reliability of the module. Always operate the regulator within the specified safe operating area (SOA) limits for the worst-case conditions of ambient temperature and airflow.

Output On/Off Inhibit

For applications requiring output voltage on/off control, each series of the MPDTH family incorporates an output Inhibit control pin. The inhibit feature can be used wherever there is a requirement for the output voltage from the regulator to be turned off.

The power modules function normally when the Inhibit pin is left open-circuit, providing a regulated output whenever a valid source voltage is connected to V_{in} with respect to GND. Figure 11 shows the typical application of the inhibit function. Note the discrete transistor (Q1). The Inhibit input has its own internal pull-up to a potential of 5 V to 13.2 V (see footnotes to electrical characteristics table). The input is not compatible with TTL logic devices. An open-collector (or open-drain) discrete transistor is recommended for control.

Figure 11: Inhibit Control Circuit

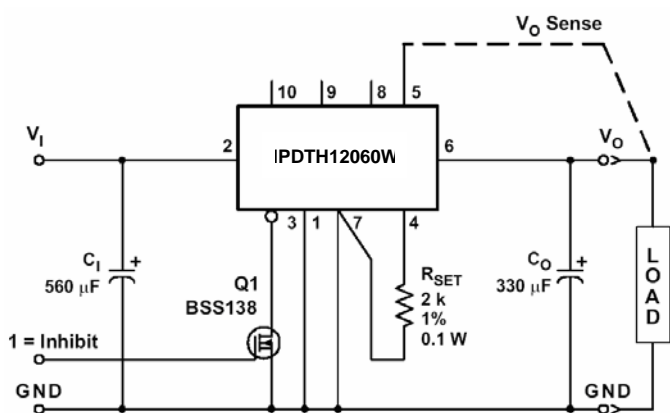

⚠ Note:

1. This datasheet is downloaded from the website of Murata Manufacturing co., Ltd. Therefore, it's specifications are subject to change or our products in it may be discontinued without advance notice. Please check with our sales representatives or product engineers before ordering.
2. This datasheet has only typical specifications because there is no space for detailed specifications. Therefore, please approve our product specifications or transact the approval sheet for product specifications before ordering.

Turning Q1 on applies a low voltage to the Inhibit control pin and disables the output of the module. If Q1 is then turned off, the module executes a soft-start power-up sequence. A regulated output voltage is produced within 25 ms. Figure 12 shows the typical rise in both the output voltage and input current, following the turn-off of Q1. The turn off of Q1 corresponds to the rise in the waveform, Q1 VDS. The waveforms were measured with a 5-A constant current load.

Figure 12: Power-Up from Inhibit Control

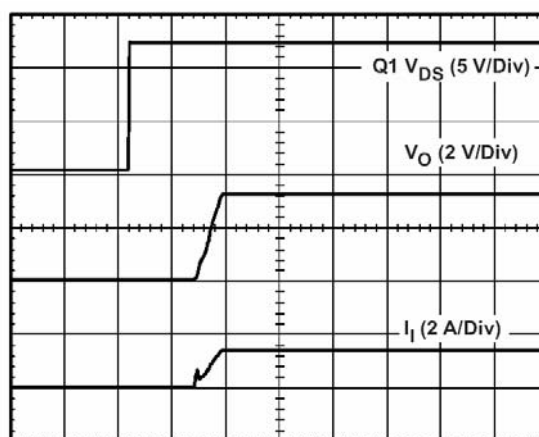

HORIZONTAL SCALE: 10 ms/Div

Remote Sense

Products with this feature incorporate an output voltage sense pin, VO Sense. A remote sense improves the load regulation performance of the module by allowing it to compensate for any IR voltage drop between its output and the load. An IR drop is caused by the high output current flowing through the small amount of pin and trace resistance.

To use this feature simply connect the VO Sense pin to the VO node, close to the load circuit. If a sense pin is left open-circuit, an internal low-value resistor (15-Ω or less) connected between the pin and the output node, ensures the output remains in regulation.

With the sense pin connected, the difference between the voltage measured directly between the VO and GND pins, and that measured from VO Sense to GND, is the amount of IR drop being compensated by the regulator.

This should be limited to a maximum of 0.3 V.

Note: The remote sense feature is not designed to compensate for the forward drop of nonlinear or frequency dependent components that may be placed in series with the converter output. Examples include OR-ing diodes, filter inductors, ferrite beads, and fuses. When these components are enclosed by the remote sense connection they are effectively placed inside the regulation control loop, which can adversely affect the stability of the regulator.

Auto-Track™ Function

The Auto-Track function is unique to the MPDTH family, and is available with all POLA products. Auto-Track was designed to simplify the amount of circuitry required to make the output voltage from each module power up and power down in sequence. The sequencing of two or more supply voltages during power up is a common requirement for complex mixed-signal applications that use dual-voltage VLSI ICs such as the TMS320™ DSP family, microprocessors, and ASICs.

How Auto-Track™ Works

Auto-Track works by forcing the module output voltage to follow a voltage presented at the *Track* control pin (1). This control range is limited to between 0 V and the module set-point voltage. Once the *Track*-pin voltage is raised above the set-point voltage, the module output remains at its set-point (2). As an example, if the *Track* pin of a 2.5-V regulator is at 1 V, the regulated output is 1 V. If the voltage at the *Track* pin rises to 3 V, the regulated output does not go higher than 2.5 V.

When under Auto-Track control, the regulated output from the module follows the voltage at its *Track* pin on a volt-for-volt basis. By connecting the *Track* pin of a number of these modules together, the output voltages follow a common signal during power up and power down. The control signal can be an externally generated master ramp waveform, or the output voltage from another power supply circuit (3). For convenience, the *Track* input incorporates an internal RC-charge circuit. This operates off the module input voltage to produce a suitable rising waveform at power up.

Typical Application

The basic implementation of Auto-Track allows for simultaneous voltage sequencing of a number of Auto-Track compliant modules. Connecting the *Track* inputs of two or more modules forces their *Track* input to follow the same collective RC-ramp waveform, and allows their power-up sequence to be coordinated from a common *Track* control signal. This can be an open-collector (or open-drain) device, such as a power-up reset voltage supervisor IC. See U3 in Figure 13.

To coordinate a power-up sequence, the *Track* control must first be pulled to ground potential. This should be done at or before input power is applied to the modules. The ground signal should be maintained for at least 20 ms after input power has been applied. This brief period gives the modules time to complete their internal soft-start initialization (4), enabling them to produce an output voltage. A low-cost supply voltage supervisor IC, that includes a built-in time delay, is an ideal component for automatically controlling the *Track* inputs at power up.

⚠ Note:

1. This datasheet is downloaded from the website of Murata Manufacturing co., ltd. Therefore, it's specifications are subject to change or our products in it may be discontinued without advance notice. Please check with our sales representatives or product engineers before ordering.
2. This datasheet has only typical specifications because there is no space for detailed specifications. Therefore, please approve our product specifications or transact the approval sheet for product specifications before ordering.

Figure 13 shows how the TL7712A supply voltage supervisor IC (U3) can be used to coordinate the sequenced power MPDTH12040W modules. The output of the TL7712A supervisor becomes active above an input voltage of 3.6 V, enabling it to assert a ground signal to the common *Track* control well before the input voltage has reached the module's undervoltage lockout threshold. The ground signal is maintained until approximately 28 ms after the input voltage has risen above U3's voltage threshold, which is 10.95 V. The 28-ms time period is controlled by the capacitor C3. The value of 2.2 μ F provides sufficient time delay for the modules to complete their internal soft-start initialization. The output voltage of each module remains at zero until the *Track* control voltage is allowed to rise. When U3 removes the ground signal, the *Track* control voltage automatically rises. This causes the output voltage of each module to rise simultaneously with the other modules, until each reaches its respective set-point voltage.

Figure 14 shows the output voltage waveforms from the circuit of Figure 13 after input voltage is applied to the circuit. The waveforms, VO1 and VO2, represent the output voltages from the two power modules, U1 (3.3 V) and U2 (1.8 V), respectively. VTRK, VO1, and VO2 are shown rising together to produce the desired simultaneous power-up characteristic.

The same circuit also provides a power-down sequence. When the input voltage falls below U3's voltage threshold, the ground signal is re-applied to the common *Track* control. This pulls the *Track* inputs to zero volts, forcing the output of each module to follow, as shown in Figure 15. In order for a simultaneous power-down to occur, the *Track* inputs must be pulled low before the input voltage has fallen below the modules' undervoltage lockout. This is an important constraint. Once the modules recognize that a valid input voltage is no longer present, their outputs can no longer follow the voltage applied at their *Track* input. During a power-down sequence, the fall in the output voltage from the modules is limited by the maximum output capacitance and the Auto-Track slew rate.

Notes on Use of Auto-Track™

1. The *Track* pin voltage must be allowed to rise above the module set-point voltage before the module regulates at its adjusted set-point voltage.
2. The Auto-Track function tracks almost any voltage ramp during power up, and is compatible with ramp speeds of up to 1 V/ms.
3. The absolute maximum voltage that may be applied to the *Track* pin is the input voltage V_{in} .
4. The module cannot follow a voltage at its *Track* control input until it has completed its soft-start initialization. This takes about 20 ms from the time that a valid voltage has been applied to its input. During this period, it is recommended that the *Track* pin be held at ground potential.
5. The Auto-Track function is disabled by connecting the *Track* pin to the input voltage (V_{in}). When Auto-Track is disabled, the output voltage rises at a quicker and more linear rate after input power has been applied.

Figure 13; Sequenced Power Up & Power Down Using Auto-Track

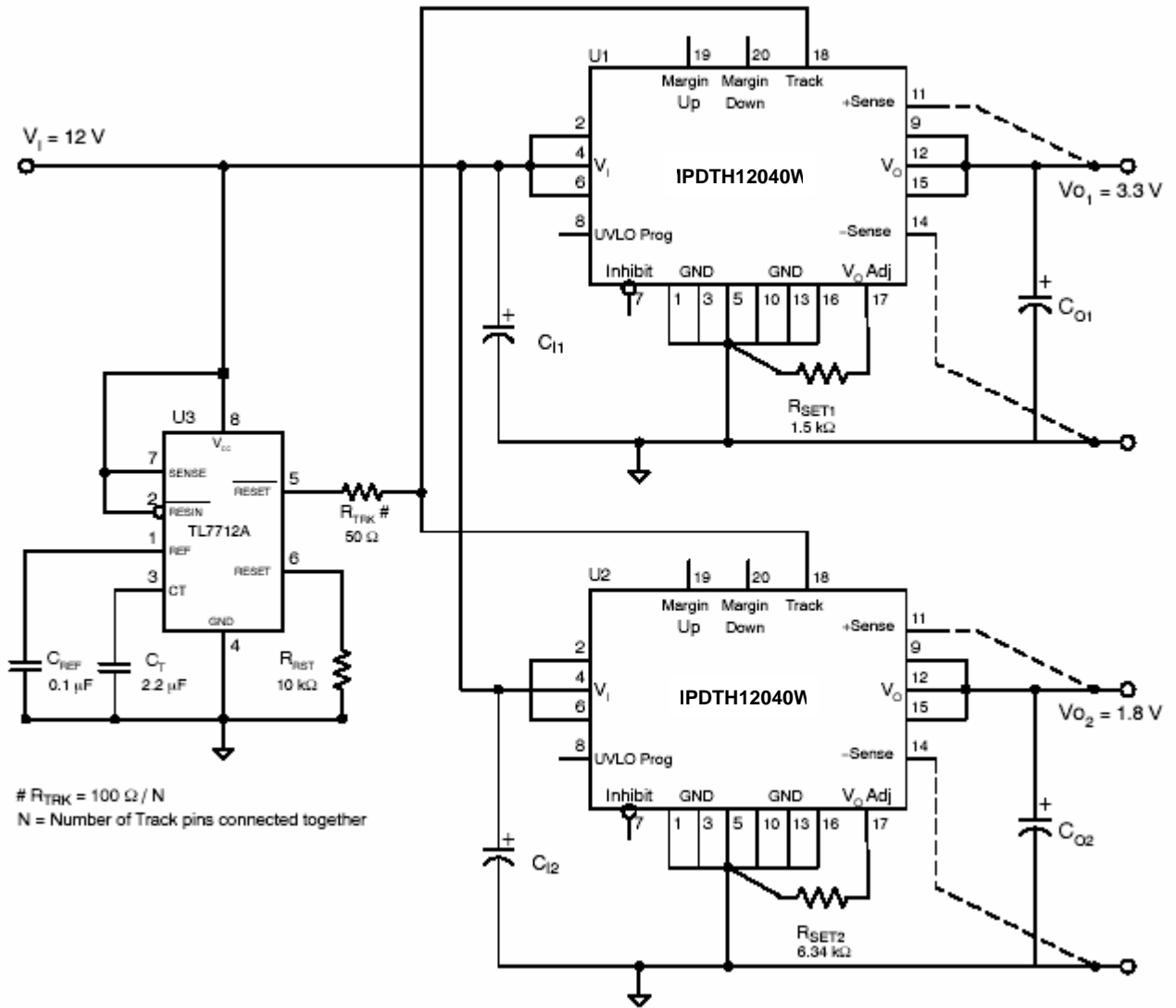

Figure 14; Simultaneous Power Up with Auto-Track Control

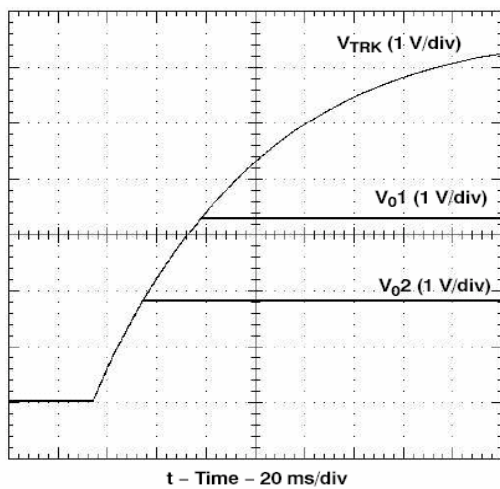
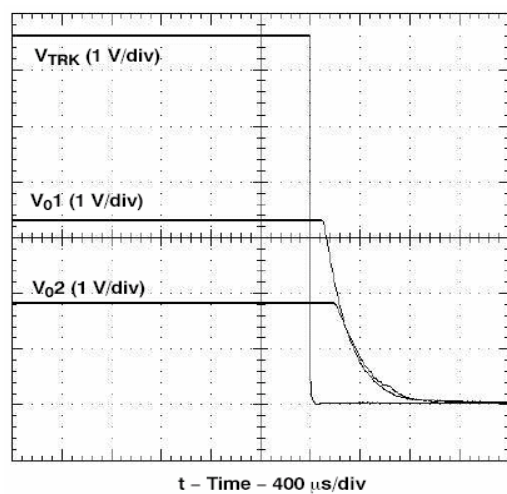

Figure 15; Simultaneous Power Down with Auto-Track Control



Note:

1. This datasheet is downloaded from the website of Murata Manufacturing co., ltd. Therefore, it's specifications are subject to change or our products in it may be discontinued without advance notice. Please check with our sales representatives or product engineers before ordering.
2. This datasheet has only typical specifications because there is no space for detailed specifications. Therefore, please approve our product specifications or transact the approval sheet for product specifications before ordering.

Margin Up/Down Controls

The MPDTH12060, MPDTH12010, MPDTH12020, MPDTH12030, and MPDTH12040 products incorporate Margin Up and Margin Down control inputs. These controls allow the output voltage to be momentarily adjusted,[1] either up or down, by a nominal 5%. This provides a convenient method for dynamically testing the operation of the load circuit over its supply margin or range. It can also be used to verify the function of supply voltage supervisors. The $\pm 5\%$ change is applied to the adjusted output voltage, as set by the external resistor, RSET at the VO Adjust pin. The 5% adjustment is made by pulling the appropriate margin control input directly to the GND terminal [2]. A low-leakage open-drain device, such as an n-channel MOSFET or p-channel JFET is recommended for this purpose[3]. Adjustments of less than 5% can also be accommodated by adding series resistors to the control inputs. The value of the resistor can be selected from Table 5, or calculated using Equation 4.

Up/Down Adjust Resistance Calculation

To reduce the margin adjustment to a value less than 5%, series resistors are required (see RD and RU in Figure 16). For the same amount of adjustment, the resistor value calculated for RU and RD is the same. The formula is shown in Equation 4.

$$RU \text{ or } RD = \frac{499}{\Delta\%} - 99.8 \text{ k}\Omega \quad (4)$$

Where $\Delta\%$ = The desired amount of margin adjust in percent.

Notes

1. The Margin Up and Margin Down controls were not intended to be activated simultaneously. The effects on the output voltage may not completely cancel, resulting in the possibility of a higher error in the output voltage set point.
2. The ground reference should be a direct connection to the module's signal GND (the GND connection recommended for RSET). This produces a more accurate adjustment at the load circuit terminals. The transistors Q1 and Q2 should be located close to the regulator.
3. The Margin Up and Margin Down control inputs are not compatible with devices that source voltage. This includes TTL logic. These are analog inputs and should only be controlled with a true open-drain device (preferably a discrete MOSFET transistor). The device selected should have low off-state leakage current. Each input sources 8 μA when grounded, and has an open-circuit voltage of 0.8 V.

Table 5: Margin Up/Down Resistor Values

%Adjust	RU / RD
5	0.0k Ω
4	24.9k Ω
3	66.5k Ω
2	150k Ω
1	397k Ω

Figure 16; Margin Up/Down Application Schematic

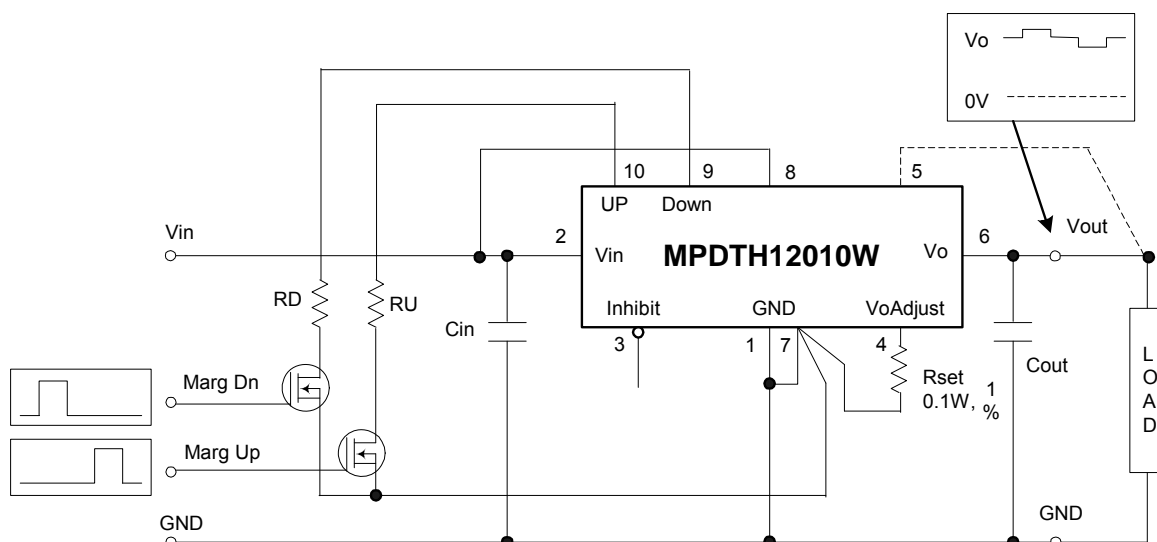

⚠ Note:

1. This datasheet is downloaded from the website of Murata Manufacturing co., Ltd. Therefore, it's specifications are subject to change or our products in it may be discontinued without advance notice. Please check with our sales representatives or product engineers before ordering.
2. This datasheet has only typical specifications because there is no space for detailed specifications. Therefore, please approve our product specifications or transact the approval sheet for product specifications before ordering.

Pre-Bias Startup Capability

The capability to start up into an output pre-bias condition is available to all the 12-V input series of MPDTH power modules.

A pre-bias startup condition occurs as a result of an external voltage being present at the output of a power module prior to its output becoming active. This often occurs in complex digital systems when current from another power source is back fed through a dual-supply logic component, such as an FPGA or ASIC. Another path might be via clamp diodes, sometimes used as part of a dual-supply power-up sequencing arrangement. A pre-bias can cause problems with power modules that incorporate synchronous rectifiers. This is because under most operating conditions, such modules can sink as well as source output current. The 12-V input MPDTH modules all incorporate synchronous rectifiers, but do not sink current during startup, or whenever the Inhibit pin is held low. Start up includes an initial delay (approximately 8–15 ms), followed by the rise of the output voltage under the control of the module's internal soft-start mechanism; see Figure 17.

Conditions for Pre-Bias Holdoff

For the module to allow an output pre-bias voltage to exist (and not sink current), certain conditions must be maintained. The module holds off a pre-bias voltage when the Inhibit pin is held low, and whenever the output is allowed to rise under soft-start control. Power up under soft-start control occurs upon the removal of the ground signal to the Inhibit pin (with input voltage applied), or when input power is applied with Auto-Track disabled [1]. To further ensure that the regulator doesn't sink output current, (even with a ground signal applied to its Inhibit), the input voltage must always be greater than the applied pre-bias source. This condition must exist throughout the power-up sequence.

The soft-start period is complete when the output begins rising above the pre-bias voltage. Once it is complete the module functions as normal, and sinks current if a voltage higher than the nominal regulation value is applied to its output.

Note: If a pre-bias condition is not present, the soft-start period is complete when the output voltage has risen to either the set-point voltage, or the voltage applied at the module's Track control pin, whichever is lowest.

Demonstration Circuit

Figure 18 shows the startup waveforms for the demonstration circuit shown in Figure 19. The initial rise in V_{O2} is the pre-bias voltage, which is passed from the VCCIO to the V_{CORE} voltage rail through the ASIC. Note that the output current from the MPDTH12010L module (I_{O2}) is negligible until its output voltage rises above the applied pre-bias.

⚠ Note:

1. This datasheet is downloaded from the website of Murata Manufacturing co., Ltd. Therefore, it's specifications are subject to change or our products in it may be discontinued without advance notice. Please check with our sales representatives or product engineers before ordering.
2. This datasheet has only typical specifications because there is no space for detailed specifications. Therefore, please approve our product specifications or transact the approval sheet for product specifications before ordering.

Figure 17; MPDTH12020W Startup

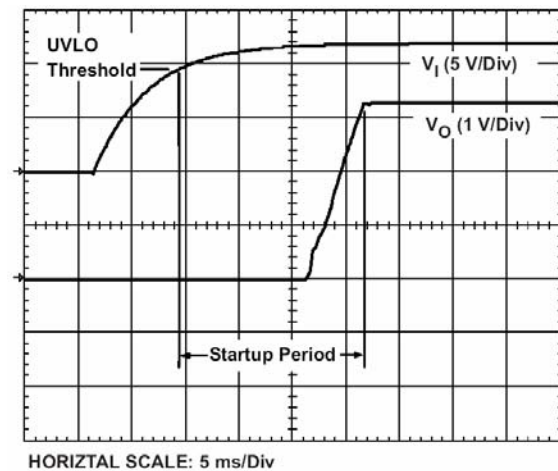
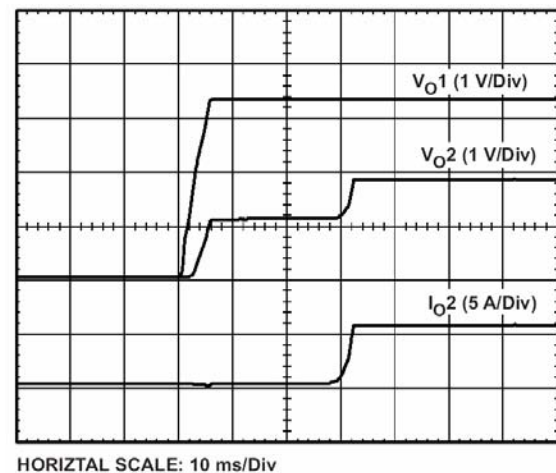

Figure 18; Pre-Bias Startup Waveforms



Note

1. The pre-bias start-up feature is not compatible with Auto-Track. If the rise in the output is limited by the voltage applied to the Track control pin, the output sinks current during the period that the Track control voltage is below that of the back-feeding source. For this reason, it is recommended that Auto-Track be disabled when not being used. This is accomplished by connecting the Track pin to the input voltage, V_{in} . This raises the Track pin voltage well above the set-point voltage prior to the module's start up, thereby defeating the Auto-Track feature.

Figure 19; Application Circuit Demonstrating Pre-Bias Startup

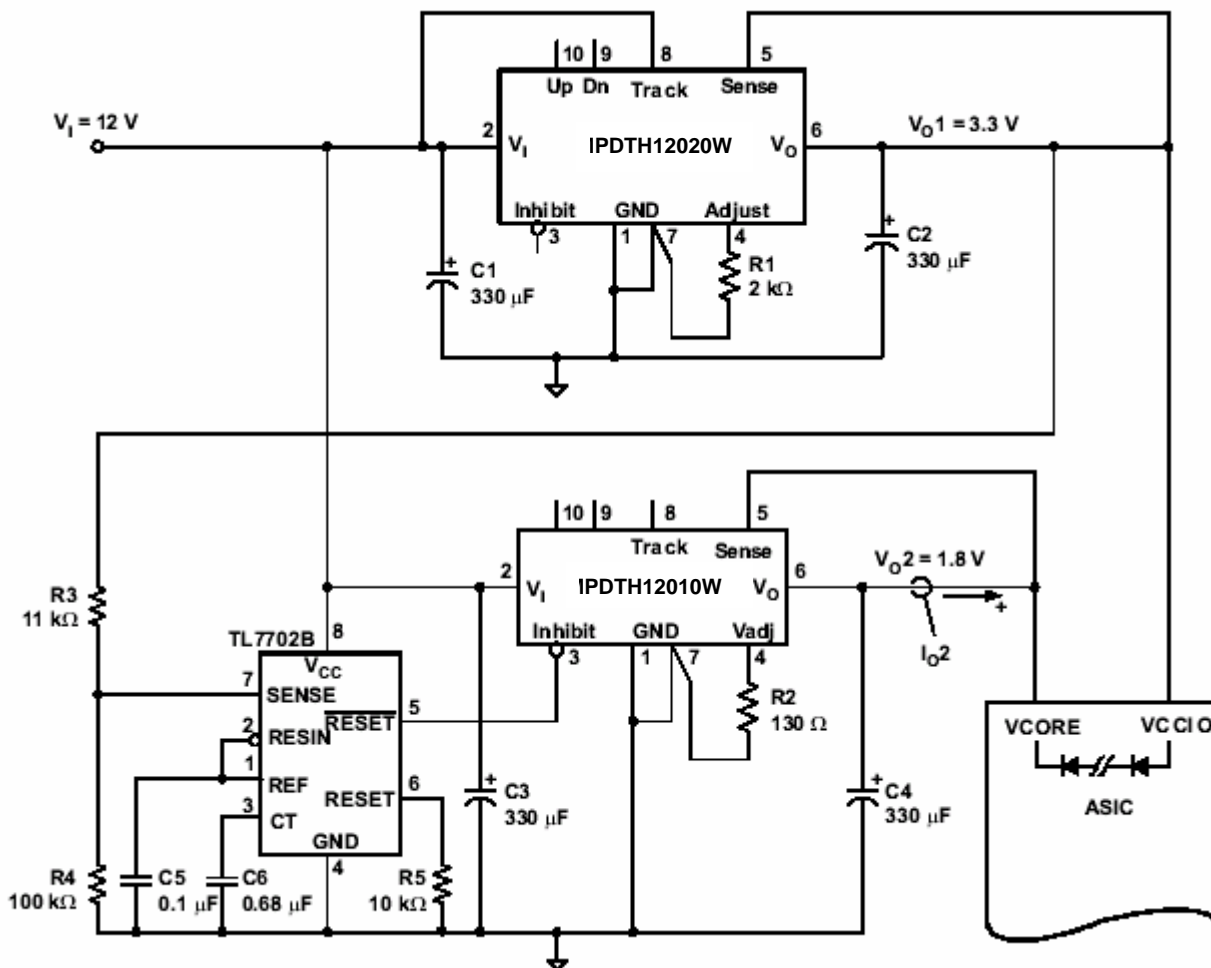
**Note:**

1. This datasheet is downloaded from the website of Murata Manufacturing co., Ltd. Therefore, it's specifications are subject to change or our products in it may be discontinued without advance notice. Please check with our sales representatives or product engineers before ordering.
2. This datasheet has only typical specifications because there is no space for detailed specifications. Therefore, please approve our product specifications or transact the approval sheet for product specifications before ordering.

MPDTH12040W : Mechanical Data

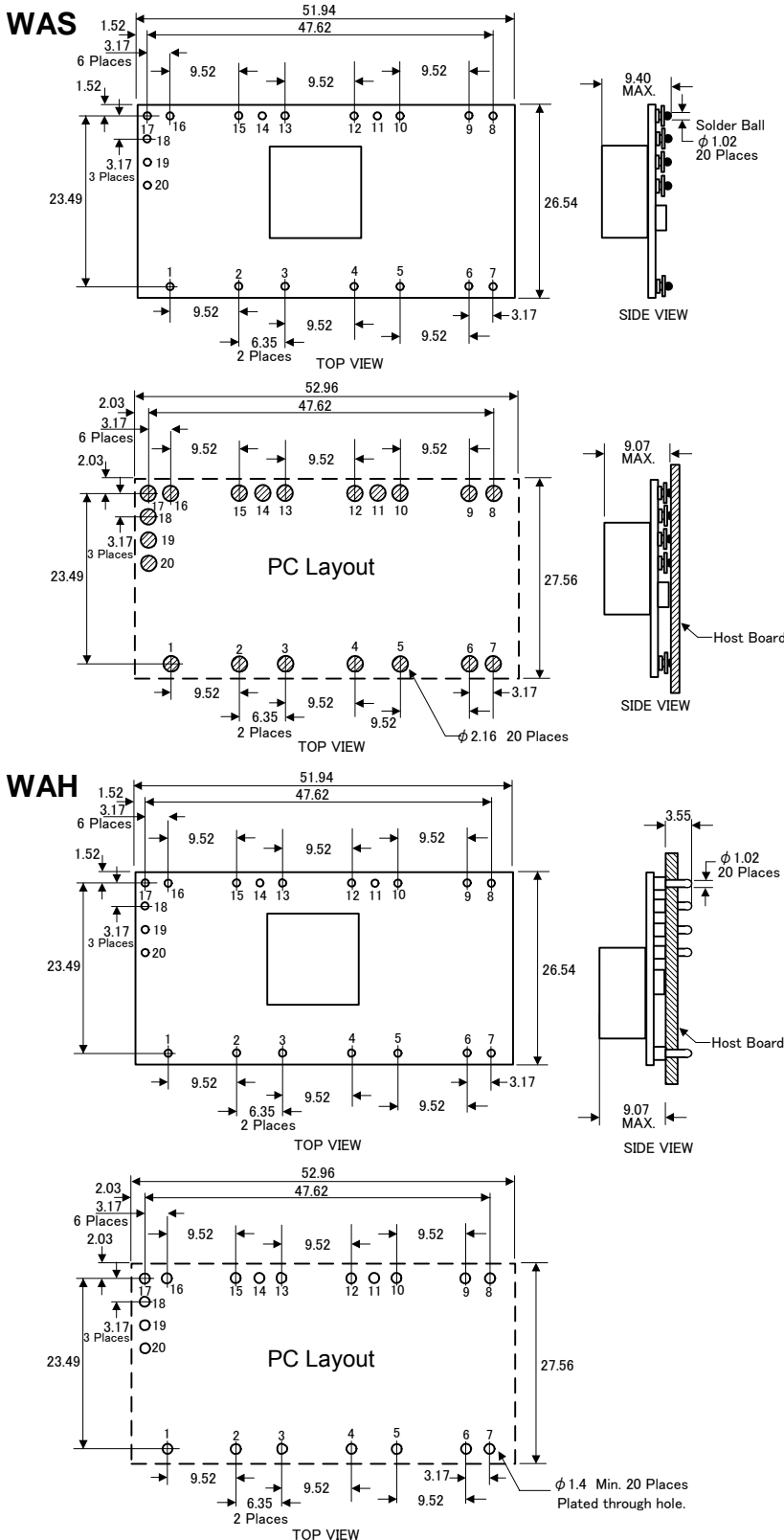

Tolerance $\pm 0.25\text{mm}$

Note:

1. This datasheet is downloaded from the website of Murata Manufacturing co., ltd. Therefore, it's specifications are subject to change or our products in it may be discontinued without advance notice. Please check with our sales representatives or product engineers before ordering.
2. This datasheet has only typical specifications because there is no space for detailed specifications. Therefore, please approve our product specifications or transact the approval sheet for product specifications before ordering.

IMPORTANT NOTICE

Murata Manufacturing Co., Ltd. and its subsidiaries (Murata) reserve the right to make corrections, modifications, enhancements, improvements, and other changes to its products and services at any time and to discontinue any product or service without notice. Customers should obtain the latest relevant information before placing orders and should verify that such information is current and complete. All products are sold subject to Murata's terms and conditions of sale supplied at the time of order acknowledgment.

Murata warrants performance of its hardware products to the specifications applicable at the time of sale in accordance with Murata's standard warranty. Testing and other quality control techniques are used to the extent Murata deems necessary to support this warranty. Except where mandated by government requirements, testing of all parameters of each product is not necessarily performed.

Murata assumes no liability for applications assistance or customer product design. Customers are responsible for their products and applications using Murata components. To minimize the risks associated with customer products and applications, customers should provide adequate design and operating safeguards.

Murata does not warrant or represent that any license, either express or implied, is granted under any Murata patent right, copyright, or other Murata intellectual property right relating to any combination, machine, or process in which Murata products or services are used. Information published by Murata regarding third-party products or services does not constitute a license from Murata to use such products or services or a warranty or endorsement thereof. Use of such information may require a license from a third party under the patents or other intellectual property of the third party, or a license from Murata under the patents or other intellectual property of Murata.

Reproduction of information in Murata data books or data sheets is permissible only if reproduction is without alteration and is accompanied by all associated warranties, conditions, limitations, and notices. Reproduction of this information with alteration is an unfair and deceptive business practice. Murata is not responsible or liable for such altered documentation.

Resale of Murata products or services with statements different from or beyond the parameters stated by Murata for that product or service voids all express and any implied warranties for the associated Murata product or service and is an unfair and deceptive business practice. MURATA is not responsible or liable for any such statements.

Copyright © 2007, Murata Manufacturing Co., Ltd.

⚠ Note:

1. This datasheet is downloaded from the website of Murata Manufacturing Co., Ltd. Therefore, its specifications are subject to change or our products in it may be discontinued without advance notice. Please check with our sales representatives or product engineers before ordering.
2. This datasheet has only typical specifications because there is no space for detailed specifications. Therefore, please approve our product specifications or transact the approval sheet for product specifications before ordering.



Компания «ЭлектроПласт» предлагает заключение долгосрочных отношений при поставках импортных электронных компонентов на взаимовыгодных условиях!

Наши преимущества:

- Оперативные поставки широкого спектра электронных компонентов отечественного и импортного производства напрямую от производителей и с крупнейших мировых складов;
- Поставка более 17-ти миллионов наименований электронных компонентов;
- Поставка сложных, дефицитных, либо снятых с производства позиций;
- Оперативные сроки поставки под заказ (от 5 рабочих дней);
- Экспресс доставка в любую точку России;
- Техническая поддержка проекта, помощь в подборе аналогов, поставка прототипов;
- Система менеджмента качества сертифицирована по Международному стандарту ISO 9001;
- Лицензия ФСБ на осуществление работ с использованием сведений, составляющих государственную тайну;
- Поставка специализированных компонентов (Xilinx, Altera, Analog Devices, Intersil, Interpoint, Microsemi, Aeroflex, Peregrine, Syfer, Eurofarad, Texas Instrument, Miteq, Cobham, E2V, MA-COM, Hittite, Mini-Circuits, General Dynamics и др.);

Помимо этого, одним из направлений компании «ЭлектроПласт» является направление «Источники питания». Мы предлагаем Вам помощь Конструкторского отдела:

- Подбор оптимального решения, техническое обоснование при выборе компонента;
- Подбор аналогов;
- Консультации по применению компонента;
- Поставка образцов и прототипов;
- Техническая поддержка проекта;
- Защита от снятия компонента с производства.



Как с нами связаться

Телефон: 8 (812) 309 58 32 (многоканальный)

Факс: 8 (812) 320-02-42

Электронная почта: org@eplast1.ru

Адрес: 198099, г. Санкт-Петербург, ул. Калинина, дом 2, корпус 4, литера А.