

# SBS® Connectors - up to 110 amps

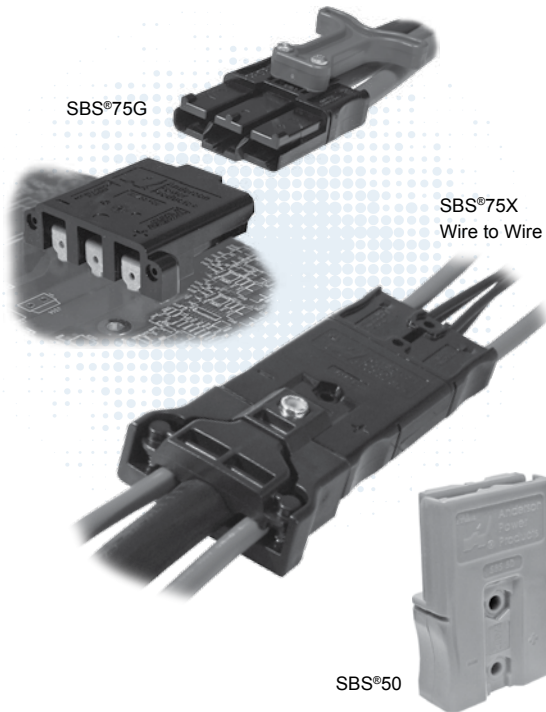

The patented SBS® connector family is designed to provide high power in a compact ergonomic housing with protection against accidental contact with live circuits. This is of particular importance in applications where DC voltages exceed 30 volts and can be health threatening.

Wire-to-wire and wire-to-board configurations both provide power contacts rated up to 110 amps. The SBS®75X offers up to 4 mate-last break-first auxiliary power / signal contacts rated up to 20 amps. The SBS®75G features a third first-mate last-break ground or power contact. All contact positions are rated for circuit interruption (hot plugging).

- **Touch Safe Interface**
  - Can safely be used in through panel applications
  - Minimizes potential contact with live circuits per IEC 60950
- **Wire-to-Wire and Wire-to-Board Configurations**
  - Allows one connector to meet multiple needs
- **Ground or Auxiliary Positions Integrated into the One Piece Housing**
  - Meets all connection requirements in one compact connector housing

## | SBS® ORDERING INFORMATION |

### SBS®50 Standard Housings

Polycarbonate housings feature 2 positions all finger proof. Genderless design mates with itself. Mechanical keys are color coded.

Description	----- Part Numbers -----	
Minimum Quantity .....	500	50 ...
Red	SBS50RED-BK	SBS50RED
Gray	SBS50GRA-BK	SBS50GRA
Blue	SBS50BLU-BK	SBS50BLU
Black	SBS50BLK-BK	SBS50BLK
Brown	SBS50BRN-BK	SBS50BRN
White	SBS50WHT-BK	SBS50WHT

### SBS®50 Chemical Resistant (CR) Housings

Same features as the standard housings, but molded out of a chemical resistant PBT/ PC blend. Suitable for use to -40°C.

Description	----- Part Numbers -----	
Minimum Quantity .....	500	50 ...
Red	PSBS50RED-BK	PSBS50RED
Gray	PSBS50GRA-BK	PSBS50GRA
Blue	PSBS50BLU-BK	PSBS50BLU
Green	PSBS50GRN-BK	PSBS50GRN
Black	PSBS50BLK-BK	PSBS50BLK
Brown	PSBS50BRN-BK	PSBS50BRN

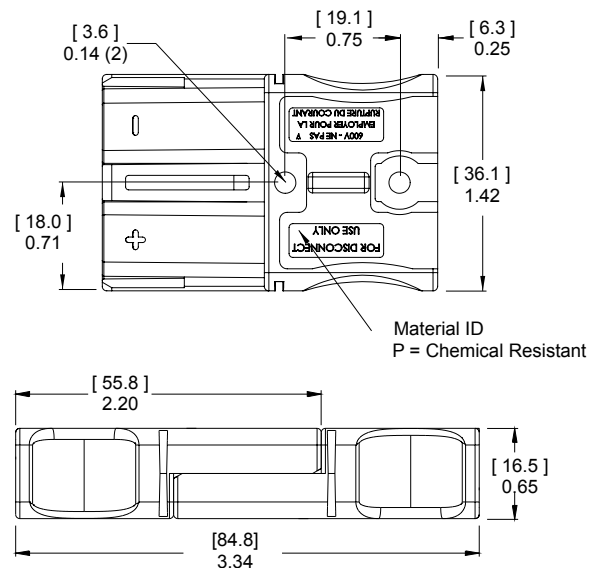

### SBS®75X Standard Housings

Polycarbonate housings feature 4 auxiliary and 2 primary positions all finger proof. Genderless design mates with itself, or the PCB connector. Mechanical keys are color coded.

Description	----- Part Numbers -----	
Minimum Quantity .....	250	50
Black	SBS75XBLK-BK	SBS75XBLK
Brown	SBS75XBRN-BK	SBS75XBRN

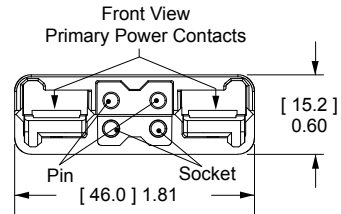

### SBS®75X Chemical Resistant (CR) Housings

Same features as the standard housings, but molded out of a chemical resistant PBT/ PC blend. Suitable for use to -40°C.

Description	----- Part Numbers -----	
Minimum Quantity .....	250	50
Green	PSBS75XGRN-BK	-
Black	PSBS75XBLK-BK	PSBS75XBLK

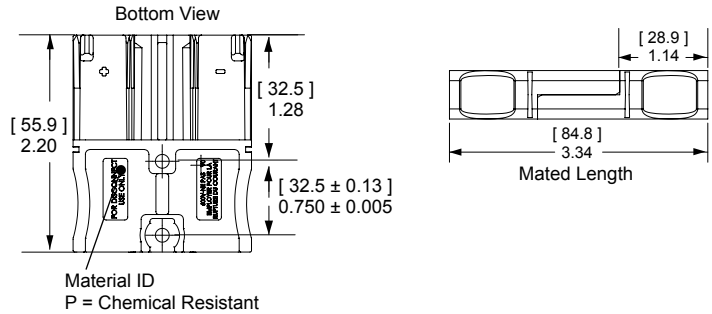

### SBS®75X Assembled PCB Connector

Fully assembled PCB connector is designed to mate with SBS®75X Wire connector. All positions are preloaded with contacts including standard mating length auxiliary positions. Press fit board locks help secure the connector to the PCB before and after soldering.

Description	--- Part Number ---
Minimum Quantity .....	100
Black	SBS75XPRBLK-BK

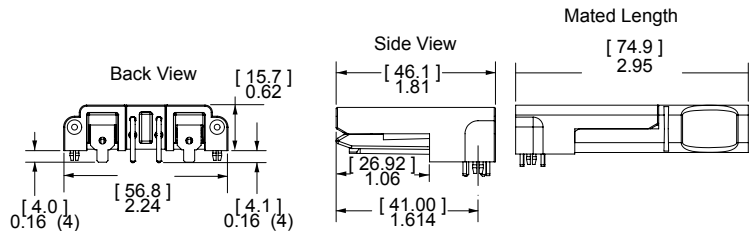

See PCB connector drawing on website for further detail.

### SBS®75G Wire Housings

Polycarbonate housings feature three finger proof positions. The center position can be used for pre-mate power or ground. Genderless design mates with itself, or the PCB connector. Mechanical keys are color coded. Inquire with customer service for chemical resistant housings.

Description	----- Part Numbers -----	
Minimum Quantity .....	250	50
Blue	SBS75GBLU-BK	SBS75GBLU
Black	SBS75GBLK-BK	SBS75GBLK
Brown	SBS75GBRN-BK	SBS75GBRN
White	SBS75GWHT-BK	SBS75GWHT

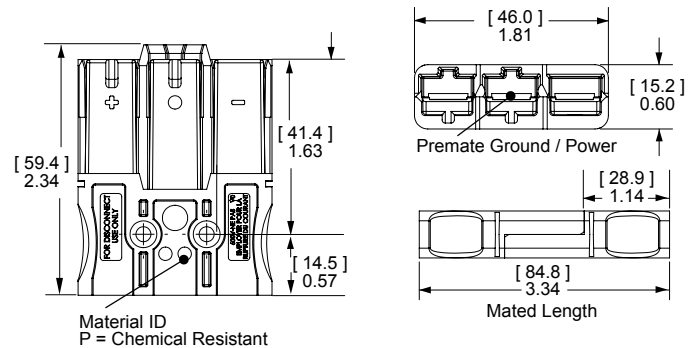

### SBS®75G Assembled PCB Connector

Fully assembled PCB connector is designed to mate with SBS®75G Wire connector. Has press fit board locks to help secure the connector to the PCB before and after soldering.

Description	--- Part Number ---
Minimum Quantity .....	100
Black	SBS75GPRBLK-BK

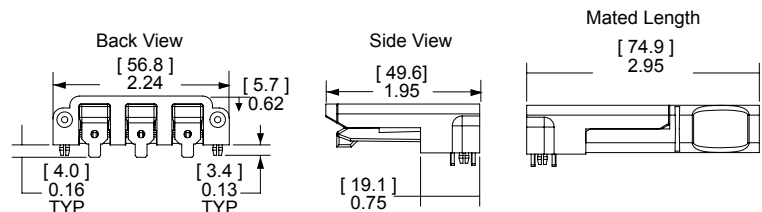

See PCB connector drawing on website for further detail.

### SBS® Silver Plated Primary Power Wire Contacts

Use two silver plated contacts per housing for the best electrical performance and durability up to 10,000 mating cycles. Standard contacts are for use in all primary power positions for SBS® 50, 75X, & 75G wire housings. See reducing bushings in accessory section for smaller wires. See reducing busings in accessory section for smaller wires.

Type	AWG	mm <sup>2</sup>	Loose Piece		Dimensions	
			----- Part Numbers -----	----- Part Numbers -----	- A -	
Minimum Quantity			1,000	100		
Standard	6	16	1339G2-BK	1339G2*	0.22	5.59
Standard	8	10	1339G5-BK	1339G5*	0.19	4.83
Standard	12 to 10	2.5 to 6	1339G3-BK	1339G3*	0.14	3.56

\* Are sold as pairs. 2 contacts ship for every 1 ordered.

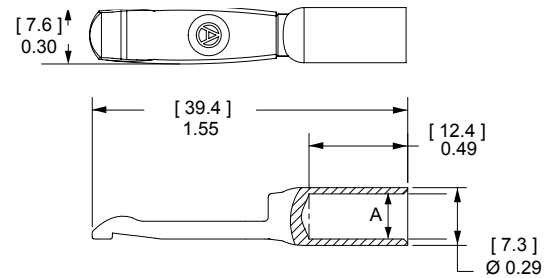

### SBS®75G Silver Plated Pre-Mate Wire Contacts

Pre-Mate contacts are for the center Pre-Mate position on the SBS®75G wire housings. See reducing bushings in accessory section for smaller wires.

Type	AWG	mm <sup>2</sup>	Loose Piece		Dimensions	
			----- Part Numbers -----	----- Part Numbers -----	- A -	
Minimum Quantity			500	50		
Pre-Mate	6	16	1340G1-BK	1340G1	0.22	5.59
Pre-Mate	8	10	1340G2-BK	1340G2	0.19	4.83
Pre-Mate	12 to 10	2.5 to 6	1340G3-BK	1340G3	0.14	3.56

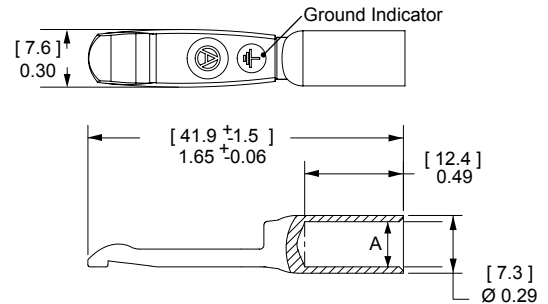

### Pin Contacts for SBS®75X Auxiliary

Gold plated contacts are available in 3 lengths to allow sequencing of circuits.

Description	AWG	mm <sup>2</sup>	----- Part Numbers -----	
			----- Part Numbers -----	----- Part Numbers -----
Minimum Quantity			500	50
Standard Length 7.7mm	12	2.5	PM16P12S30	PM16P12S30-50
	16 to 14	1.0 to 1.5	PM16P1416S30	PM16P1416S30-50
	20 to 16	0.75 to 1.0	PM16P1620S30	PM16P1620S30-50
	24 to 20	0.50 to 0.75	PM16P2024S30	PM16P2024S30-50
Pre-Mate 9.3mm	12	2.5	PM16P12A30	-
	16 to 14	1.0 to 1.5	PM16P1416A30	-
	20 to 16	0.75 to 1.0	PM16P1620A30	-
	24 to 20	0.50 to 0.75	PM16P2024A30	-
Post-Mate 6.4mm	12	2.5	PM16P12C30	-
	16 to 14	1.0 to 1.5	PM16P1416C30	-
	20 to 16	0.75 to 1.0	PM16P1620C30	-
	24 to 20	0.50 to 0.75	PM16P2024C30	-

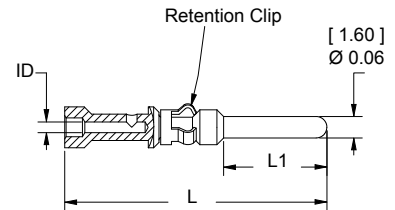

Auxiliary Pin Contact Lengths	- L -		- L1 -	
	in.	mm	in.	mm
Standard Length 7.7mm	0.77	19.6	0.30	7.7
Pre-Mate 9.3mm	0.83	21.2	0.37	9.3
Post-Mate 6.4mm	0.72	18.3	0.25	6.4

### Socket Contacts for SBS®75X Auxiliary

Selectively gold plated contacts offer low resistance and durability up to 10,000 mating cycles.

Description	AWG	mm <sup>2</sup>	----- Part Numbers -----	
			----- Part Numbers -----	----- Part Numbers -----
Minimum Quantity			500	50
Socket Contact	12	2.5	PM16S12S32	PM16S12S32-50
	16 to 14	1.0 to 1.5	PM16S1416S32	PM16S1416S32-50
	20 to 16	0.75 to 1.0	PM16S1620S32	PM16S1620S32-50
	24 to 20	0.50 to 0.75	PM16S2024S32	PM16S2024S32-50

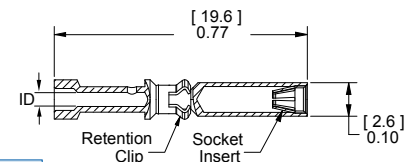

#### Auxiliary Socket Contacts Crimp Barrel ID

Wire Gauge	in.	mm.
#24 / 20	0.04	1.1
#20 / 16	0.07	1.7
#16 / 14	0.08	2.1
#12	0.10	2.6

# SBS® CONNECTOR SPECIFICATIONS

## Electrical

<b>Current Rating Amperes <sup>1</sup></b>	<b>UL 1977</b>	<b>CSA/TUV</b>
Primary Power (6 AWG)	110	75
Auxiliary (12 AWG)	20	10
<b>Voltage Rating AC/DC</b>		
UL 1977	600	
<b>Dielectric Withstanding Voltage</b>		
Volts AC	2,200	
<b>Avg. Mated Contact Resistance Milliohms <sup>1</sup></b>		
Power & Ground: 1 1/4" of #6 AWG wire	0.200	
Auxiliary: Wire & PCB	3.000	
<b>UL Hot Plug Current Rating Amperes - 250 cycles at 120V DC</b>		
Wire & PCB Power	50A	
Wire & PCB Auxiliary	5A	
<b>UL Ground Short Time Current Test - SBS75G Wire &amp; PCB</b>		
1530 Amps, #6 AWG Wire	6 seconds	

## Materials

<b>Housing</b>	
Standard Plastic Resin	Polycarbonate
Chem. Resistant Resin	Polycarbonate / PBT blend
Contact Retention Spring	Stainless Steel
<b>Housing Flammability Rating</b>	
UL94	V-0
Glow Wire - SBS50	825°C (GWFI) / 800°C (GWIT)
- SBS75G	960°C (GWFI) / 800°C (GWIT)
- SBS75X	960°C (GWFI) / 800°C (GWIT)
<b>Wire Power &amp; Ground Contact</b>	Silver Plated Copper Alloy
<b>PCB Power &amp; Ground Contact</b>	Tin Plated Copper Alloy
<b>SBS75X Auxiliary Contacts</b>	
Pin	Copper alloy, Au over Ni
Socket	BeCu, Au over Ni
Socket Body	Copper alloy, Sn bright over Ni
Retention Clip	Stainless Steel
<b>PCB Press Fit Retainers</b>	Brass - Tin Plated
<b>Contact Termination Methods</b>	
Crimp <sup>3</sup>	Wire Contacts
Hand Solder	Wire and PCB Contacts
Solder Dip	PCB Contacts
Wave Solder	PCB Contacts

## Mechanical

<b>Wire Size Range</b>	<b>AWG</b>	<b>mm<sup>2</sup></b>	
Power Contacts (with bushings)	16 to 6	1.3 to 13.3	
Auxiliary Contacts	24 to 12	0.25 to 3.3	
<b>Max. Wire Insulation Diameter</b>	<b>in.</b>	<b>mm</b>	
SBS®75G Power & Ground	0.380	9.652	
SBS®50 & SBS®75X Power Contacts	0.410	10.414	
SBS®75X Auxiliary Contacts	0.140	3.600	
<b>Operating Temperature <sup>2</sup></b>	<b>°F</b>	<b>°C</b>	
Standard	-4° to 221°	-20° to 105°	
Chemical Resistant	-40 to 221°	-40° to 105°	
<b>Mating Cycles No Load by Plating</b>	<b>Silver (Ag)</b>	<b>Tin (Sn)</b>	<b>Gold (Au)</b>
Power & Ground Contacts Wire	10,000		
Power & Ground Contacts PCB		1,500	
Auxiliary Contacts			10,000
<b>Avg. Mating / Unmating Force</b>	<b>Lbf.</b>	<b>N</b>	
SBS®75X and SBS®75G Wire to Wire	16	70	
SBS®50 Wire to Wire	8	36	
SBS®75X and SBS®75G Wire to PCB	8	36	
<b>Min. Contact / Spring Retention Force</b>	<b>Lbf.</b>	<b>N</b>	
Power, Standard Housing	50	222	
Power, Chem. Resistant Housing	30	133	
Aux. Standard Housing	15	67	
Aux. Chem. Resistant Housing	10	44	
<b>PCB Specifications</b>			
Mounting Style		Plated Through Hole	
Max PCB Thickness- in. [mm]		0.093 [2.4]	
Recommended Traces Power & Ground		#6 AWG Cross Section	
Recommended Traces Auxiliary		#12 AWG Cross Section	
<b>Min. Creepage / Clearance Distance PCB</b>	<b>in.</b>	<b>mm</b>	
Power to Aux. Creepage SBS®75X	0.41	10.4	
Power to Aux. Clearance SBS®75X	0.24	6.1	
Power to Ground Creepage SBS®75G	0.35	8.9	
Power to Ground Clearance SBS®75G	0.26	6.7	
Auxiliary Creepage SBS®75X	0.12	3.0	
Auxiliary Clearance SBS®75X	0.12	3.0	

SECTION 3  
SBS® 50 & 75



File No. E26226



CSA Certified  
File No. LR25154



Auxiliary contacts are available for SBS®75X only.

SBS®75X and SBS®75G PCB connectors are designed to mate only with the wire connector of the same series.

NOTE 1: See IEC 60664-1 for working voltage.

NOTE 2: Amp ratings are stated per position and based on all positions being fully loaded.

<sup>1</sup> Based on: 105°C rated or better cable of the largest size, Properly calibrated APP recommended tooling, and a 25°C ambient temperature.

UL rating not to exceed the maximum operating temperature. CSA rating below a 30°C temperature rise.

<sup>2</sup> Limited by the thermal properties of the connector plastic housing.

<sup>3</sup> Use APP recommended tooling only. Alternate tools may adversely affect the performance of our connectors along with UL and CSA recognition.

# IEC INFORMATION |

Connector Series	Configurations	Creepage/Clearance per IEC 60950-1	Material Group
SBS®75G	Unmated	3.33 mm	IIIa
	Mated	4.64 mm	

Connector Series	Configurations	Creepage/Clearance per IEC 60950-1	Material Group
SBS®75X	Unmated	3.33 mm	IIIa
	Mated	4.64 mm	

Connector Series	Configurations	Creepage/Clearance per IEC 60950-1	Material Group
SBS®50	Unmated	3.85 mm	IIIa
	Mated	4.64 mm	

Protection	
<b>Touch Safety with Wire Contacts &amp; PCB Mating Interface</b>	
IEC 60950	Pass
IEC 60529	IP20

Attributes	SBS50
<b>AMP Rating AC/DC - Power only</b>	6 AWGg-75a, 8 AWG 65A - 10 AWG - 45A, 12 AWG -35a
<b>Power Contacts and Aux contacts ( Aux contacts at 15 A)</b>	6 AWGg-75a, 8 AWG 60A - 10 AWG - 35A, 12 AWG -30a
- Aux Contacts	12 AWG - 15A
<b>Voltage Rating AC/DC (Steady State)</b>	600 AC/DC (Operational)
- Aux Contacts	NA
<b>Breaking Capacity -AMP Rating /Cycles - Power Contacts</b>	6 AWG -50 Amp, 120 VDC / 250 Cycles
<b>Breaking Capacity - Aux Contacts</b>	NA
<b>Voltage Rating (Breaking Capacity)</b>	120 VDC
<b>Finger Safety - Mated only</b>	IEC 60529 - IP20
<b>Wire Size tested</b>	Power 12, 10, 8, 6 AWG
<b>Contact Series Tested</b>	1339G2, 1339G3, 1339G5
- Aux contacts	NA
<b>Climatic Testing (Cold,Heat &amp; MFG)</b>	IEC 60512 Test -11j, 11i & 11g,
<b>Cycle Life</b>	IEC 60512 Test 9a - 5000 Cycles
<b>Mechanical Strength Impact</b>	IEC 60512-5 @ 29.5 Inches - dropped 8 times
<b>Temperature Range</b>	-20 °C to 105 °C -4 °F to 221 °F

Attributes	SBS75x
<b>AMP Rating AC/DC - Power only</b>	6 AWGg-75a, 8 AWG 65A - 10 AWG - 45A, 12 AWG -35a
<b>Power Contacts and Aux contacts ( Aux contacts at 15 A)</b>	6 AWGg-75a, 8 AWG 60A - 10 AWG - 35A, 12 AWG -30a
- Aux Contacts	12 AWG - 15A
<b>Voltage Rating AC/DC (Steady State)</b>	600V AC/DC ( Operational)
- Aux Contacts	12 AWG - 15A
<b>Breaking Capacity -AMP Rating /Cycles - Power Contacts</b>	6 AWG- 50 Amp, 120 VDC / 250 Cycles
<b>Breaking Capacity - Aux Contacts</b>	12 AWG -5A, 120 VDC / 250 Cycles
<b>Voltage Rating (Breaking Capacity)</b>	120 VDC
<b>Finger Safety - Mated only</b>	IEC 60529 - IP20
<b>Wire Size tested</b>	Power 12 AWG, 10 AWG , 8 AWG, 6AWG / signal 12 awg
<b>Contact Series Tested</b>	Power 1339G2, 1339G3, 1339G5
- Aux contacts	PM16P12S30, PM16S12S32
<b>Climatic Testing (Cold,Heat &amp; MFG)</b>	IEC 60512 Test -11j, 11i & 11g,
<b>Cycle Life</b>	IEC 60512 Test 9a - 5000 Cycles
<b>Mechanical Strength Impact</b>	IEC 60512-5 @ 29.5 Inches - dropped 8 times
<b>Temperature Range</b>	-20 °C to 105 °C -4 °F to 221 °F



NOTE 3: Refer to the Constructional Data form for additional information on our website., [www.andersonpower.com](http://www.andersonpower.com)

Attributes	SBS75G
<b>AMP Rating AC/DC - Power only</b>	110
<b>Power Contacts and Aux contacts ( Aux contacts at 15 A)</b>	NA
- Aux Contacts	NA
<b>Voltage Rating AC/DC (Steady State)</b>	600V AC/DC ( Operational)
- Aux Contacts	NA
<b>Breaking Capacity -AMP Rating /Cycles - Power Contacts</b>	6 AWG- 50 A, 120 VDC / 250 Cycles
<b>Breaking Capacity - Aux Contacts</b>	NA
<b>Voltage Rating (Breaking Capacity)</b>	120 VDC
<b>Finger Safety - Mated only</b>	IEC 60529 - IP10, IP20
<b>Wire Size tested</b>	6 AWG
<b>Contact Series Tested</b>	Power 1339G2, 1339G3, 1339G5 / Ground 1340G1
- Aux contacts	NA
<b>Climatic Testing (Cold,Heat &amp; MFG)</b>	IEC 60512 Test -11j, 11i & 11g,
<b>Cycle Life</b>	IEC 60512 Test 9a - 1500 Cycles
<b>Mechanical Strength Impact</b>	IEC 60512-5 @ 29.5 Inches - dropped 8 times
<b>Temperature Range</b>	-20 °C to 105 °C -4 °F to 221 °F

Attributes	SBS75G and GPR (PCB)
<b>AMP Rating AC/DC - Power only</b>	110
<b>Power Contacts and Aux contacts ( Aux contacts at 15 A)</b>	NA
- Aux Contacts	NA
<b>Voltage Rating AC/DC (Steady State)</b>	600V AC/DC (Operational)
- Aux Contacts	NA
<b>Breaking Capacity -AMP Rating /Cycles - Power Contacts</b>	6 AWG- 50 A,120 VDC / 250 Cycles
<b>Breaking Capacity - Aux Contacts</b>	NA
<b>Voltage Rating (Breaking Capacity)</b>	120 VDC
<b>Finger Safety - Mated only</b>	IEC 60529 - IP20
<b>Wire Size tested</b>	6 AWG
<b>Contact Series Tested</b>	Power B02075P1 / Ground B02114P1
- Aux contacts	NA
<b>Climatic Testing (Cold,Heat &amp; MFG)</b>	IEC 60512 Test -11j, 11i & 11g,
<b>Cycle Life</b>	IEC 60512 Test 9a - 1500 Cycles
<b>Mechanical Strength Impact</b>	NA
<b>Temperature Range</b>	-20 °C to 105 °C -4 °F to 221 °F



NOTE 3: Refer to the Constructional Data form for additional information on our website., [www.andersonpower.com](http://www.andersonpower.com)

# SBS® CONNECTOR TEMPERATURE CHARTS | Temperature rise charts are based on a 25°C ambient temperature.

For Temperature Rise Above 60°C, Consult the Extended Temperature Rise Charts in the Appropriate Product Section on the Website.

Current - Temperature Derating per IEC 60512-5-2 Test 5B

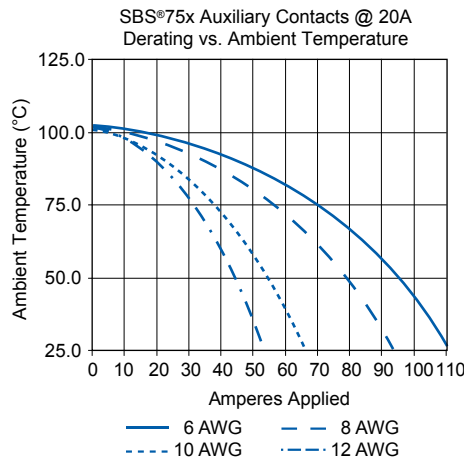
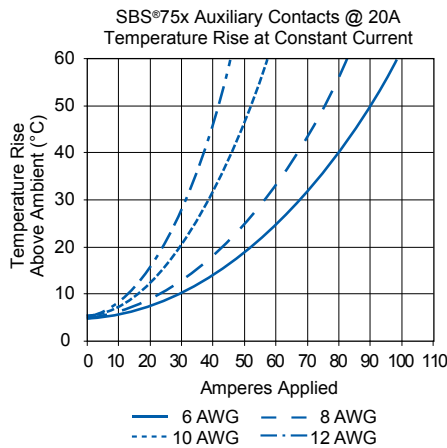
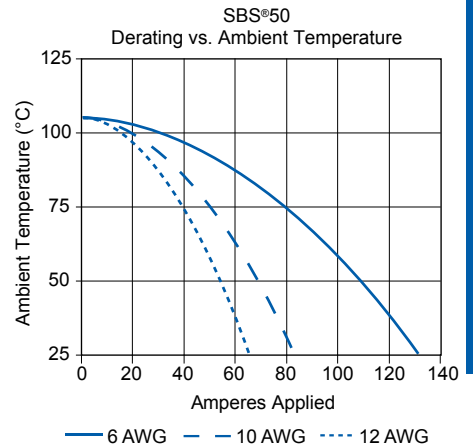
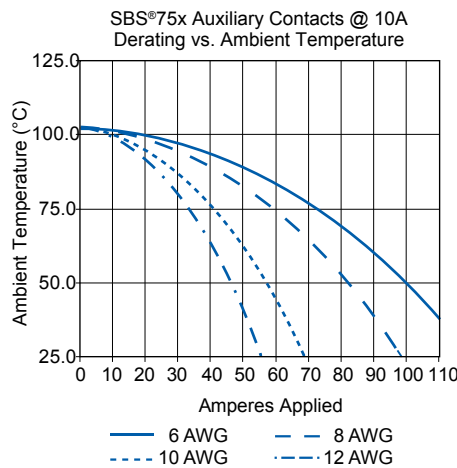
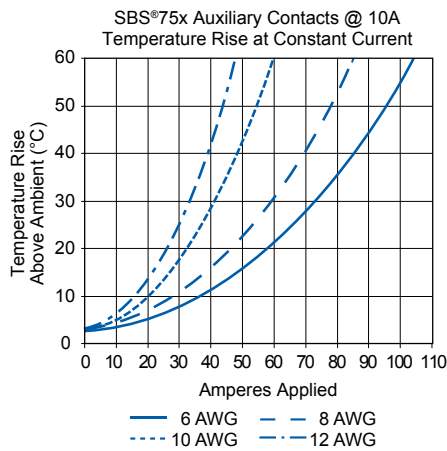
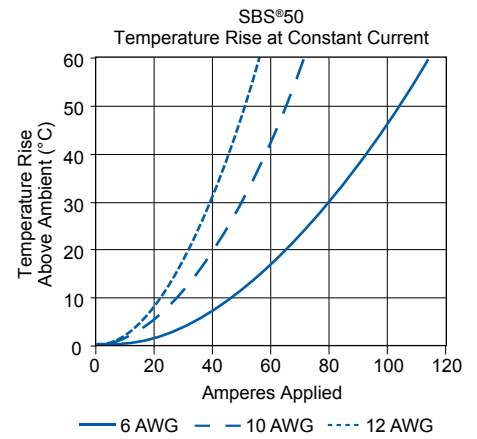
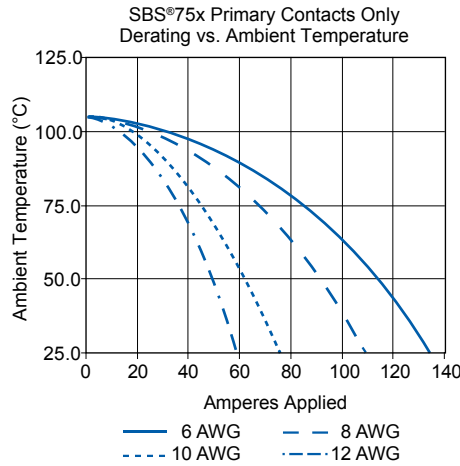
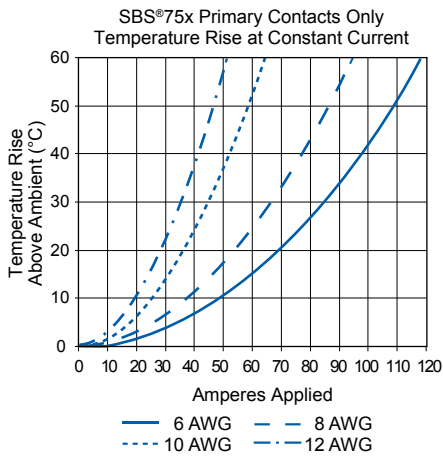

**SECTION 3  
SBS® 50 & 75**



For Temperature Rise Above 60°C, Consult the Extended Temperature Rise Charts in the Appropriate Product Section on the Website.

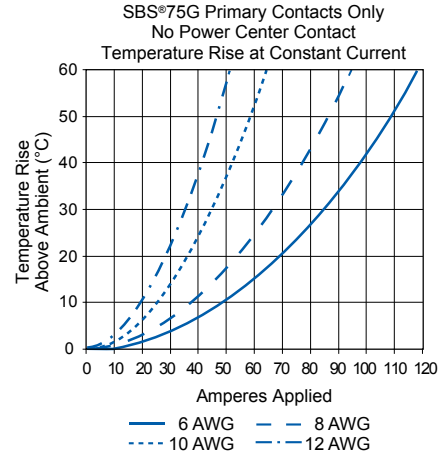
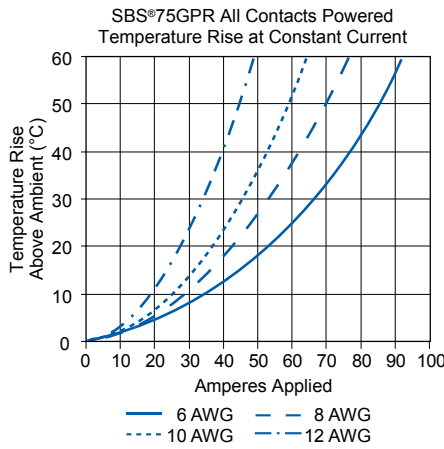
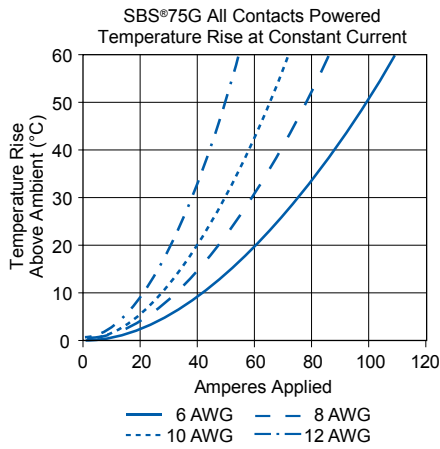

Current - Temperature Derating per IEC 60512-5-2 Test 5B

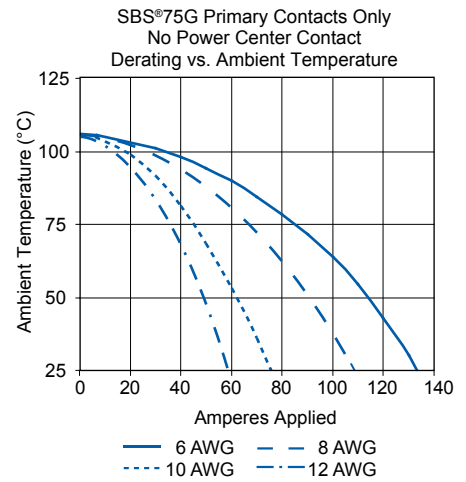
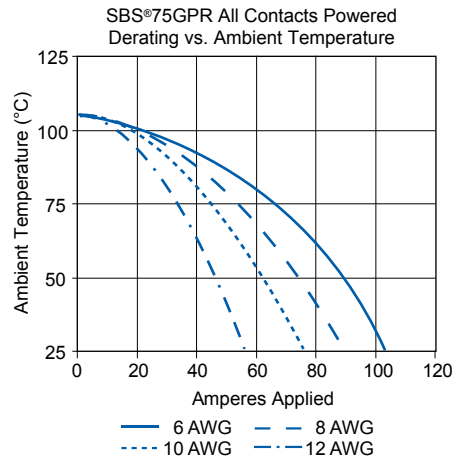
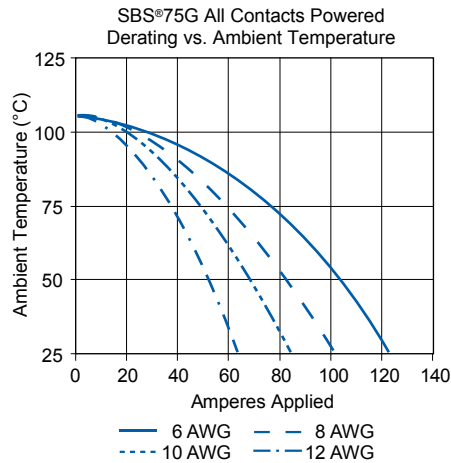

SECTION 3  
SBS® 50 & 75

## SBS® ACCESSORIES |

### Mounting Clamp for SBS®50

Mounting clamps can be used for fastening a SBS®50 series housings to a panel. Fastening hardware not included.

Description	--- Part Number ---
Minimum Quantity .....	20 sets of 2 .....
Panel Mount Bracket for SBS®50	1466G1

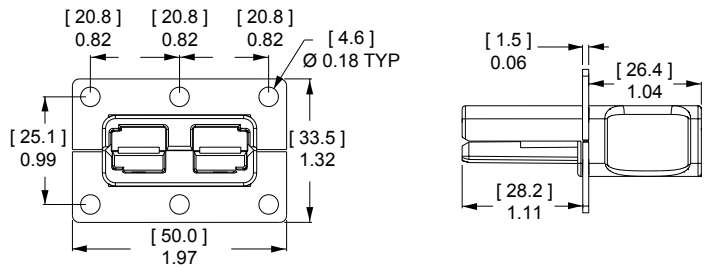

### T-Handle for SBS®50 and SBS®75X

The "T" handle makes mating and unmating the connector easier. The non-conductive red plastic material is strong and safe. (2) Self tapping screws are used to secure the handle to the connector housing.

Description	----- Part Numbers -----	
Minimum Quantity .....	1,000	50 .....
Red "T" Handle + Hardware Bag	-	SBS50-HDL-RED
Hardware Bag (2 Screws)	-	104G17
Red "T" Handle Only	113899P1	-
#8 x 5/8" Screw (Order 2 Per Handle)	H1120P55	-

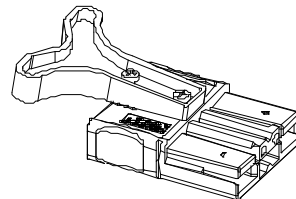



### "A" frame handle for SBS®50 and SBS®75X

Handle makes mating and unmating the connector easier. The non-conductive gray plastic material is strong and safe. Machine screws and locknuts included.

Description	- Part Number -
Minimum Quantity .....	200 .....
Gray "A" Handle & Hardware	997G1

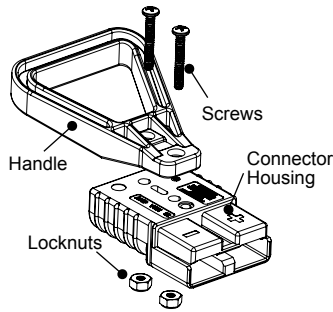

### T-Handle for SBS®75G

The "T" handle makes mating and unmating the connector easier. The non-conductive red plastic material is strong and safe. (2) Machine screws and lock nuts.

Description	- Part Number -
Minimum Quantity .....	50 .....
Red "T" Handle + Hardware Bag	SBS75GHDLRED

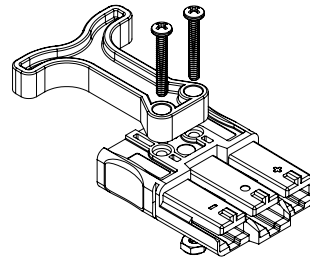

### Dust Cover SBS®50

Prevents dust and dirt from entering the mating interface of the connector when unmated. NOTE: Not a Hermetic Seal.

Description	----- Part Number -----
Minimum Quantity .....	500 50 ...
Dust Cover with Lanyard Strap, Red	113890P1 134G1

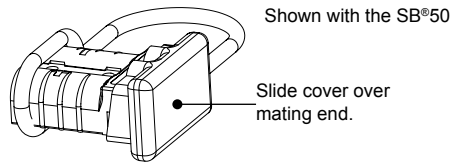

### Cable Clamps for SBS®50

Durable metal cable clamps securely hold cables to prevent accidental strain or pulls from dislodging wire or contacts from the housing. Cable clamps are recommended for solder terminated wires.

Description	Cable Size		----- Part Numbers -----	
	AWG or (Inches O.D.)	mm <sup>2</sup> or (mm O.D.)		
Minimum Quantity .....			500	50 ...
Self Attaching for Discrete Conductor	8 to 6	10	990-BK	990
Self Attaching for Discrete Conductor	12 to 10	2.5 to 4	990G2-BK	990G2
Bolt On for Discrete Conductor	12 to 6	2.5 to 10	990G1-BK	990G1
Bolt On for Bundled Conductor	(0.320 to 0.450)	(4.27 to 11.43)	5905-BK	5905

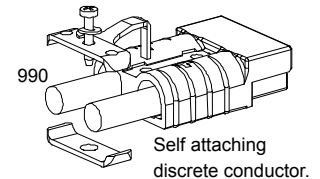
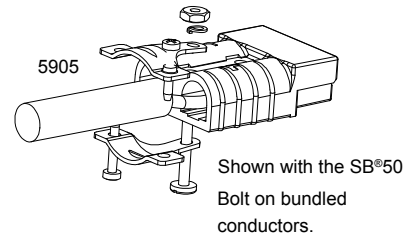

The given wire O.D. information is an estimate. Cable clamps should be evaluated for performance with the actual wire to be used.

### Cable Clamps for SBS®75X with Integral Handle

Rugged chemical resistant PBT/ PC plastic cable clamps securely hold cables to prevent accidental strain or pulls from dislodging wire or contacts from the housing. Cable clamps are recommended for solder terminated wires.

Description	Cable Size AWG or (Inches O.D.)	mm <sup>2</sup> or (mm O.D.)	----- Part Numbers -----	
Minimum Quantity .....			100	25 .....
Large Wire Clamp Kit w/ Hardware	12 to 6 (0.39 to 0.60)	4 to 10 (9.9 to 15.2)	PSBS75XCLP1-BK	PSBS75XCLP1
Small Wire Clamp Kit w/ Hardware	12 to 6 (0.34 to 0.55)	4 to 10 (8.6 to 14.0)	PSBS75XCLP2-BK	PSBS75XCLP2

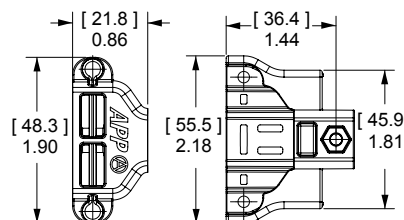

The given wire O.D. information is an estimate. Cable clamps should be evaluated for performance with the actual wire to be used.

Clamp hardware requires phillips or flat blade screwdriver to assemble.

## Reducing Bushings

Use with contact part number 1339G2-BK or 1340G1-BK to allow a smaller wire to be used with the connector. Electrical capability is derated with smaller wire.

Contact Barrel Size	Wire Size	Part Numbers			Dimensions			
		-----	-----	-----	- ID -	- Length -	- ID -	- Length -
Minimum Quantity		3,000	1,000	100	inches	mm	inches	mm
#6 AWG [13.3 mm <sup>2</sup> ]	#8 AWG [8.4 mm <sup>2</sup> ]	-	5912-BK	5912	0.18	4.57	0.45	11.43
#6 AWG [13.3 mm <sup>2</sup> ]	#12- 10 AWG [3.3- 5.3 mm <sup>2</sup> ]	5910-BK	-	5910	0.14	3.56	0.47	11.94
#6 AWG [13.3 mm <sup>2</sup> ]	#16- 14 AWG [1.3- 2.1 mm <sup>2</sup> ]	5913-BK	-	5913	0.09	2.29	0.47	11.94

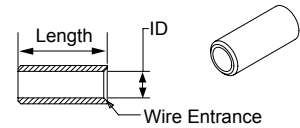

## SBS® - Tooling Information

Wire Size		Power / Ground Contacts								
AWG	mm <sup>2</sup>	Power Contact Part Number	Pneumatic Bench Tool	+	Die	+	Locator	Number of Crimps	or	Hand Tool
#6	13.3	1339G2	1387G1		1388G6		1389G9	Single		1309G4
#8	8.4	1339G5			1388G7					
#10 / 12	5.3 / 3.3	1339G3			1388G6	1389G20				
#6	13.3	1340G1			1388G7					
#8	8.4	1340G2								
#10 / 12	5.3 / 3.3	1340G3								

Wire Size		SBS®75X Auxiliary Contacts								
AWG	mm <sup>2</sup>	Auxiliary Contact Part Number	APP Hand Tool w/ Integral Locator	or	Mil Std. Hand Tool* M22520/1-01	or	Pneumatic Tool*	Number of Crimps	+	Locator for: TM0001 & TP0001
#12 / 24	2.5 / 0.25	All Crimp Pins	PM1000G1		TM0001		TP0001	Single		TL0001
		All Crimp Sockets				TL0002				

\* TP0001 and TM0001 tools require locators TL0001 for Pins and TL0002 for Sockets.  
NOTE: See website for the most current information.

SBS®75X Auxiliary Contact Insertion Tool: PM1002G1  
SBS®75X Auxiliary Contact Extraction Tool: PM1003G1  
SBS®75X Auxiliary Contact Insertion Inspection Tool: PM1003GX

The auxiliary contacts used with wire sizes #16 - #24 AWG cannot be properly inserted without the insertion tool. Properly installed auxiliary contact of all wire gauges cannot be removed from the hosing without the extraction tool.

SECTION 3  
SBS® 50 & 75

# Mouser Electronics

Authorized Distributor

Click to View Pricing, Inventory, Delivery & Lifecycle Information:

[Anderson Power Products:](#)

[1339g2](#) [1339g2-bk](#) [1339G3](#) [1339G3-BK](#) [1339g5](#) [1339g5-bk](#)



Компания «ЭлектроПласт» предлагает заключение долгосрочных отношений при поставках импортных электронных компонентов на взаимовыгодных условиях!

Наши преимущества:

- Оперативные поставки широкого спектра электронных компонентов отечественного и импортного производства напрямую от производителей и с крупнейших мировых складов;
- Поставка более 17-ти миллионов наименований электронных компонентов;
- Поставка сложных, дефицитных, либо снятых с производства позиций;
- Оперативные сроки поставки под заказ (от 5 рабочих дней);
- Экспресс доставка в любую точку России;
- Техническая поддержка проекта, помощь в подборе аналогов, поставка прототипов;
- Система менеджмента качества сертифицирована по Международному стандарту ISO 9001;
- Лицензия ФСБ на осуществление работ с использованием сведений, составляющих государственную тайну;
- Поставка специализированных компонентов (Xilinx, Altera, Analog Devices, Intersil, Interpoint, Microsemi, Aeroflex, Peregrine, Syfer, Eurofarad, Texas Instrument, Miteq, Cobham, E2V, MA-COM, Hittite, Mini-Circuits, General Dynamics и др.);

Помимо этого, одним из направлений компании «ЭлектроПласт» является направление «Источники питания». Мы предлагаем Вам помощь Конструкторского отдела:

- Подбор оптимального решения, техническое обоснование при выборе компонента;
- Подбор аналогов;
- Консультации по применению компонента;
- Поставка образцов и прототипов;
- Техническая поддержка проекта;
- Защита от снятия компонента с производства.



#### Как с нами связаться

**Телефон:** 8 (812) 309 58 32 (многоканальный)

**Факс:** 8 (812) 320-02-42

**Электронная почта:** [org@eplast1.ru](mailto:org@eplast1.ru)

**Адрес:** 198099, г. Санкт-Петербург, ул. Калинина, дом 2, корпус 4, литера А.