

NCS210R, NCV210R, NCS211R, NCV211R, NCS213R, NCV213R, NCS214R, NCV214R



ON Semiconductor®

www.onsemi.com

Current-Shunt Monitors, Voltage Output, Bidirectional Zero-Drift, Low- or High-Side Current Sensing

The NCS210R, NCS211R, NCS213R and NCS214R are voltage output, current shunt monitors (also called current sense amplifiers) which can measure voltage across shunts at common-mode voltages from -0.3 V to 26 V , independent of supply voltage. The low offset of the zero-drift architecture enables current sensing across the shunt with maximum voltage drop as low as 10 mV full-scale. These devices can operate from a single $+2.2\text{ V}$ to $+26\text{ V}$ power supply, drawing a maximum of $80\text{ }\mu\text{A}$ of supply current, and are specified over the extended operating temperature range (-40°C to $+125^\circ\text{C}$). Available in the SC70-6 and UQFN10 packages.

Features

- Wide Common Mode Input Range: -0.3 V to 26 V
- Supply Voltage Range: 2.2 V to 26 V
- Low Offset Voltage: $\pm 35\text{ }\mu\text{V}$ max
- Low Offset Drift: $0.5\text{ }\mu\text{V}/^\circ\text{C}$
- Low Gain Error: 1% max
- Low Gain Error Drift: $10\text{ ppm}/^\circ\text{C}$ max
- Rail-to-Rail Output Capability
- Low Current Consumption: $40\text{ }\mu\text{A}$ typ, $80\text{ }\mu\text{A}$ max
- NCV Prefix for Automotive and Other Applications Requiring Unique Site Qualified and PPAP Capable

Typical Applications

- Current Sensing (High-Side/Low-Side)
- Automotive
- Telecom
- Power Management
- Battery Charging and Discharging



UQFN10
MU SUFFIX
CASE 488AT



SC70-6
SQ SUFFIX
CASE 419B

MARKING DIAGRAM



XXX = Specific Device Code
M = Date Code
▪ = Pb-Free Package
(Note: Microdot may be in either location)

PIN CONNECTIONS



*NC denotes no internal connection. These pins can be left floating or connected to any voltage between V_S and GND.

ORDERING INFORMATION

See detailed ordering, marking and shipping information on page 2 of this data sheet.

NCS210R, NCV210R, NCS211R, NCV211R, NCS213R, NCV213R, NCS214R, NCV214R



$$V_{OUT} = (I_{LOAD} \times R_{SHUNT})GAIN + V_{REF}$$

Figure 1. Example Application Schematic of High-Side Current Sensing

ORDERING INFORMATION

Device	Gain	R3 and R4	R1 and R2	Marking	Package	Shipping†
NCS210RSQT2G	200	5 kΩ	1 MΩ	AVY	SC70-6	3000 / Tape and Reel
NCV210RSQT2G*	200	5 kΩ	1 MΩ	AVY	SC70-6	3000 / Tape and Reel
NCS210RMUTAG	200	5 kΩ	1 MΩ	CP	UQFN10	3000 / Tape and Reel
NCS211RSQT2G	500	2 kΩ	1 MΩ	AVZ	SC70-6	3000 / Tape and Reel
NCV211RSQT2G*	500	2 kΩ	1 MΩ	AVZ	SC70-6	3000 / Tape and Reel
NCS213RSQT2G	50	20 kΩ	1 MΩ	AV3	SC70-6	3000 / Tape and Reel
NCV213RSQT2G*	50	20 kΩ	1 MΩ	AV3	SC70-6	3000 / Tape and Reel
NCS214RSQT2G	100	10 kΩ	1 MΩ	AV4	SC70-6	3000 / Tape and Reel
NCV214RSQT2G*	100	10 kΩ	1 MΩ	AV4	SC70-6	3000 / Tape and Reel
NCS214RMUTAG	100	10 kΩ	1 MΩ	CR	UQFN10	3000 / Tape and Reel
NCS211RMUTAG	500	2 kΩ	1 MΩ	CM	UQFN10	3000 / Tape and Reel
NCS213RMUTAG	50	20 kΩ	1 MΩ	CQ	UQFN10	3000 / Tape and Reel

†For information on tape and reel specifications, including part orientation and tape sizes, please refer to our Tape and Reel Packaging Specifications Brochure, BRD8011/D.

*NCV Prefix for Automotive and Other Applications Requiring Unique Site and Control Change Requirements; AEC-Q100 Qualified and PPAP Capable.

Table 1. MAXIMUM RATINGS

Parameter		Symbol	Value	Unit
Supply Voltage (Note 1)		V_S	+30	V
Analog Inputs	Differential (V_{IN+})–(V_{IN-})	V_{IN+}, V_{IN-}	–30 to +30	V
	Common–Mode (Note 2)		(GND–0.3) to +30	
REF Input		V_{REF}	(GND–0.3) to (V_S +0.3)	V
Output (Note 2)		V_{OUT}	(GND–0.3) to (V_S +0.3)	V
Input Current into Any Pin (Note 2)			5	mA
Maximum Junction Temperature		$T_{J(max)}$	+150	°C
Storage Temperature Range		TSTG	–65 to +150	°C
ESD Capability, Human Body Model (Note 3)		HBM	±2000	V
Charged Device Model (Note 3)		CDM	±2000	V
Latch–Up Current (Note 4)		I_{LU}	100	mA

Stresses exceeding those listed in the Maximum Ratings table may damage the device. If any of these limits are exceeded, device functionality should not be assumed, damage may occur and reliability may be affected.

1. Refer to ELECTRICAL CHARACTERISTICS, RECOMMENDED OPERATING RANGES and/or APPLICATION INFORMATION for safe operating parameters.
2. Input voltage at any pin may exceed the voltage shown if current at that pin is limited to 5 mA.
3. This device series incorporates ESD protection and is tested by the following methods:
 ESD Human Body Model tested per JEDEC standard JS–001–2017 (AEC–Q100–002).
 ESD Charged Device Model tested per JEDEC standard JS–002–2014 (AEC–Q100–011).
4. Latch–up Current tested per JEDEC standard JESD78E (AEC–Q100–004)

Table 2. RECOMMENDED OPERATING RANGES

Parameter	Symbol	Min	Typ	Max	Unit
Common–mode input voltage	V_{CM}	–0.3	12	26	V
Supply Voltage	V_S	2.2	5	26	V
Ambient Temperature	T_A	–40		125	°C

Functional operation above the stresses listed in the Recommended Operating Ranges is not implied. Extended exposure to stresses beyond the Recommended Operating Ranges limits may affect device reliability.

Table 3. THERMAL CHARACTERISTICS (Note 5)

Parameter	Symbol	Value	Unit
Thermal Resistance, Junction–to–Air (Note 6)	SC70	250	°C/W
	UQFN10	150	

5. Refer to ELECTRICAL CHARACTERISTICS, RECOMMENDED OPERATING RANGES and/or APPLICATION INFORMATION for safe operating parameters.
6. Values based on copper area of 645 mm² (or 1 in²) of 1 oz copper thickness and FR4 PCB substrate.

NCS210R, NCV210R, NCS211R, NCV211R, NCS213R, NCV213R, NCS214R, NCV214R

Table 4. ELECTRICAL CHARACTERISTICS At $T_A = +25^\circ\text{C}$, $V_{\text{SENSE}} = V_{\text{IN}+} - V_{\text{IN}-}$;

NCS210R, NCS213R and NCS214R: $V_S = +5\text{ V}$, $V_{\text{IN}+} = 12\text{ V}$, and $V_{\text{REF}} = V_S/2$, unless otherwise noted.

NCS211R: $V_S = +12\text{ V}$, $V_{\text{IN}+} = 12\text{ V}$, and $V_{\text{REF}} = V_S/2$, unless otherwise noted.

Boldface limits apply over the specified temperature range of $T_A = -40^\circ\text{C}$ to 125°C , guaranteed by characterization and/or design.

Symbol	Parameter		Test Conditions	Min	Typ	Max	Unit
INPUT							
V_{CM}	Common-Mode Input Voltage Range			-0.3		26	V
CMRR	Common-Mode Rejection Ratio	NCx210R, NCx211R, NCx214R	$V_{\text{IN}+} = 0\text{ V to }+26\text{ V}$, $V_{\text{SENSE}} = 0\text{ mV}$ $T_A = -40^\circ\text{C to }125^\circ\text{C}$	105	125		dB
		NCx213R			120		
V_{OS}	Offset Voltage RTI (Note 7)	NCx210R, NCx211R	$V_{\text{SENSE}} = 0\text{ mV}$		± 0.55	± 35	μV
		NCx213R			± 5	± 100	
		NCx214R			± 1	± 60	
dV_{OS}/dT	RTI vs Temperature (Note 7)	NCx21xR	$V_{\text{SENSE}} = 0\text{ mV}$ $T_A = -40^\circ\text{C to }+125^\circ\text{C}$		0.1	0.5	$\mu\text{V}/^\circ\text{C}$
PSRR	RTI vs Power Supply Ratio (Note 7)		$V_S = +2.7\text{ V to }+26\text{ V}$, $V_{\text{IN}+} = 18\text{ V}$, $V_{\text{SENSE}} = 0\text{ mV}$		± 0.1	± 10	$\mu\text{V}/\text{V}$
I_{IB}	Input Bias Current		$V_{\text{SENSE}} = 0\text{ mV}$		39	60	μA
I_{IO}	Input Offset Current		$V_{\text{SENSE}} = 0\text{ mV}$		± 0.1		μA

OUTPUT

G	Gain	NCx210R			200		V/V
		NCx211R			500		
		NCx213R			50		
		NCx214R			100		
E_G	Gain Error	NCx21xR	$V_{\text{SENSE}} = -5\text{ mV to }5\text{ mV}$, $T_A = -40^\circ\text{C to }125^\circ\text{C}$		± 0.2	± 1	%
E_G	Gain Error vs Temperature	NCx21xR	$T_A = -40^\circ\text{C to }125^\circ\text{C}$		3	10	ppm/ $^\circ\text{C}$
	Nonlinearity Error		$V_{\text{SENSE}} = -5\text{ mV to }5\text{ mV}$		± 0.01		%
C_L	Maximum Capacitive Load		No sustained oscillation		1		nF

VOLTAGE OUTPUT

V_{OH}	Swing to V_S Power Supply Rail		$R_L = 10\text{ k}\Omega$ to GND $T_A = -40^\circ\text{C to }+125^\circ\text{C}$ (Note 8)		$V_S - 0.075$	$V_S - 0.2$	V
V_{OL}	Swing to GND		$R_L = 10\text{ k}\Omega$ to GND $T_A = -40^\circ\text{C to }+125^\circ\text{C}$		$V_{\text{GND}} + 0.005$	$V_{\text{GND}} + 0.05$	V

FREQUENCY RESPONSE

BW	Bandwidth ($f_{-3\text{dB}}$)	NCx210R	$C_{\text{LOAD}} = 10\text{ pF}$		40		kHz
		NCx211R			25		
		NCx213R			90		
		NCx214R			60		
SR	Slew Rate				1		V/ μs

NOISE

e_n	Voltage Noise Density		$f = 1\text{ kHz}$		45		
-------	-----------------------	--	--------------------	--	----	--	--

POWER SUPPLY

V_S	Operating Voltage Range		$T_A = -40^\circ\text{C to }+125^\circ\text{C}$	2.2		26	V
I_Q	Quiescent Current		$V_{\text{SENSE}} = 0\text{ mV}$		40	80	μA
	Quiescent Current over Temperature		$T_A = -40^\circ\text{C to }+125^\circ\text{C}$			100	μA

7. RTI = referenced-to-input

8. $V_S = 5\text{ V}$ for NCx211R

Product parametric performance is indicated in the Electrical Characteristics for the listed test conditions, unless otherwise noted. Product performance may not be indicated by the Electrical Characteristics if operated under different conditions.

TYPICAL CHARACTERISTICS ($T_A = 25^\circ\text{C}$, $V_S = 5\text{ V}$, $V_{IN+} = 12\text{ V}$ and $V_{REF} = V_S/2$ unless otherwise noted.)
 (The NCS210R is used for Typical Characteristics)



Figure 2. Input Offset Voltage Production Distribution



Figure 3. Input Offset Voltage vs. Temperature



Figure 4. Common-Mode Rejection Production Distribution



Figure 5. Common-Mode Rejection Ratio vs. Temperature



Figure 6. Gain Error Production Distribution



Figure 7. Gain Error vs. Temperature

TYPICAL CHARACTERISTICS ($T_A = 25^\circ\text{C}$, $V_S = 5\text{ V}$, $V_{IN+} = 12\text{ V}$ and $V_{REF} = V_S/2$ unless otherwise noted.)
 (The NCS210R is used for Typical Characteristics)



Figure 8. Gain vs. Frequency



Figure 9. Power Supply Rejection Ratio vs. Frequency



Figure 10. Common-Mode Rejection Ratio vs. Frequency



Figure 11. Positive Output Voltage Swing vs. Output Current, $V_S = 2.2\text{ V}$



Figure 12. Negative Output Voltage Swing vs. Output Current, $V_S = 2.2\text{ V}$



Figure 13. Positive Output Voltage Swing vs. Output Current, $V_S = 2.7\text{ V}$

TYPICAL CHARACTERISTICS ($T_A = 25^\circ\text{C}$, $V_S = 5\text{ V}$, $V_{IN+} = 12\text{ V}$ and $V_{REF} = V_S/2$ unless otherwise noted.)
 (The NCS210R is used for Typical Characteristics)



Figure 14. Negative Output Voltage Swing vs. Output Current, $V_S = 2.7\text{ V}$



Figure 15. Positive Output Voltage Swing vs. Output Current, $V_S = 5\text{ V}$



Figure 16. Negative Output Voltage Swing vs. Output Current, $V_S = 5\text{ V}$



Figure 17. Positive Output Voltage Swing vs. Output Current, $V_S = 26\text{ V}$



Figure 18. Negative Output Voltage Swing vs. Output Current, $V_S = 26\text{ V}$



Figure 19. Input Bias Current vs. Common-Mode Voltage with $V_S = 5\text{ V}$

TYPICAL CHARACTERISTICS ($T_A = 25^\circ\text{C}$, $V_S = 5\text{ V}$, $V_{IN+} = 12\text{ V}$ and $V_{REF} = V_S/2$ unless otherwise noted.)
 (The NCS210R is used for Typical Characteristics)



Figure 20. Input Bias Current vs. Common-Mode Voltage with $V_S = 0\text{ V}$ (Shutdown)

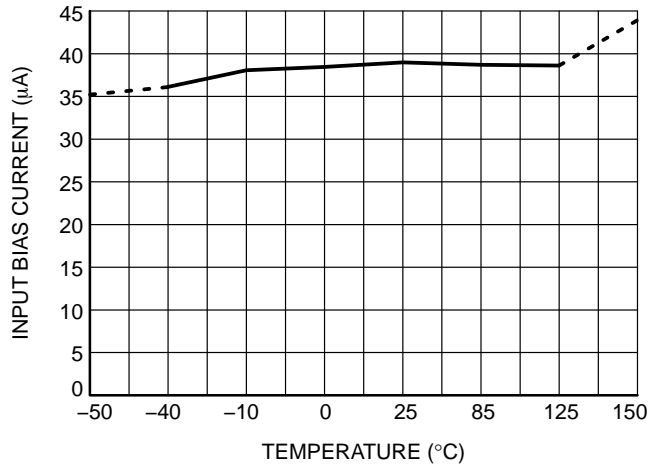

Figure 21. Input Bias Current vs. Temperature



Figure 22. Quiescent Current vs. Temperature

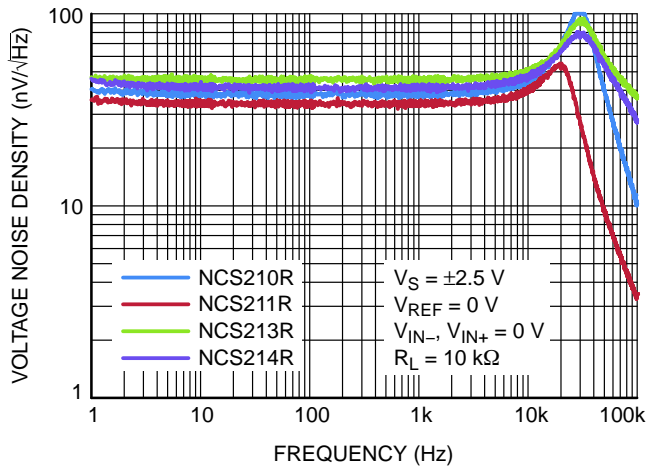

Figure 23. Voltage Noise Density vs. Frequency



Figure 24. 0.1 Hz to 10 Hz Voltage Noise (Referred to Input)

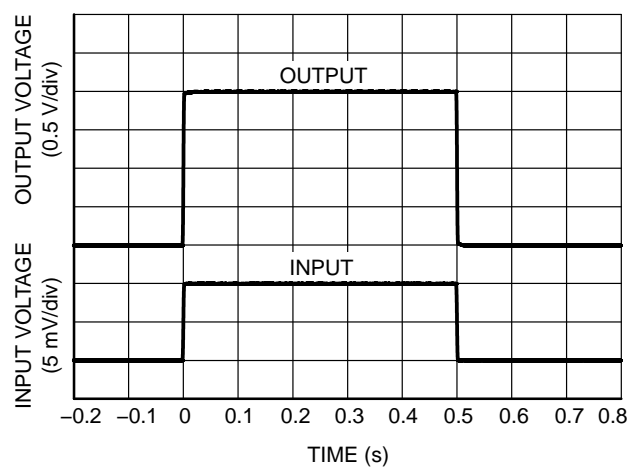

Figure 25. Step Response (10 mVpp Input Step)

TYPICAL CHARACTERISTICS ($T_A = 25^\circ\text{C}$, $V_S = 5\text{ V}$, $V_{\text{IN}+} = 12\text{ V}$ and $V_{\text{REF}} = V_S/2$ unless otherwise noted.)
 (The NCS210R is used for Typical Characteristics)



Figure 26. Common-Mode Voltage Transient Response



Figure 27. Inverting Differential Input Overload



Figure 28. Noninverting Differential Input Overload



Figure 29. Start-Up Response



Figure 30. Brownout Recovery

Basic Connections

Current Sensing Techniques

The NCS21xR current-sense amplifiers can be configured for both low-side and high-side current sensing. Low-side sensing appears to have the advantage of being straightforward, inexpensive, and can be implemented with a simple op amp circuit. However, the NCS21xR series of devices provides the full differential input necessary to get accurate shunt connections, while also providing a built-in gain network with precision difficult to obtain with external resistors. While at times the application requires low-side sensing, only high-side sensing can detect a short from the positive supply line to ground. Furthermore, high-side sensing avoids adding resistance to the ground path of the load being measured. The sections below focus primarily on high-side current sensing.

Unidirectional Operation

In unidirectional current sensing, the current always flows in the same direction. Common applications for unidirectional operation include power supplies and load

current monitoring. Figure 31 shows the NCS21xR circuit implementation for unidirectional operation using high-side current sensing.

Basic connections for unidirectional operation include connecting the load power supply, connecting a current shunt to the differential inputs of the NCS21xR, grounding the REF pin, and providing a power supply for the NCS21xR. The NCS21xR can be connected to the same power supply that it is monitoring current from, or it can be connected to a separate power supply. If it is necessary to detect short circuit current on the load power supply, which may cause the load power supply to sag to near zero volts, a separate power supply must be used on the NCS21xR. When using multiple supplies, there are no restrictions on power supply sequencing.

When no current is flowing through the R_{SHUNT} , and the REF pin is connected to ground, the NCS21xR output is expected to be within 50 mV of ground. When current is flowing through R_{SHUNT} , the output will swing positive, up to within 200 mV of the applied supply voltage, V_S .



Figure 31. Basic Unidirectional Connection

Bidirectional Operation

In bidirectional current sensing, the current measurements are taken when current is flowing in both directions. For example, in fuel gauging, the current is measured when the battery is being charged or discharged. Bidirectional operation requires the output to swing both positive and negative around a bias voltage applied to the

REF pin. The voltage applied to the REF pin depends on the application. However, most often it is biased to either half of the supply voltage or to half the value of the measurement system reference. Figure 32 shows bidirectional operation with three different circuit choices that can be connected to the REF pin to provide a voltage reference to the NCS21xR.



Figure 32. Bidirectional Current Sensing with Three Example Voltage Reference Circuits

The REF pin must always be connected to a low impedance circuit, such as in the Figure 32(b), (c), and (d). The REF pin can be connected directly to any voltage supply or voltage reference (shunt or series). However, if a resistor divider network is used to provide the reference voltage, a unity gain buffer circuit must be used, as shown in Figure 32(d).

In bidirectional applications, any voltage that exceeds $V_S + 0.3$ V applied to the REF pin will forward bias an ESD diode between the REF pin and the V_S pin. Note that this exceeds the Absolute Maximum Ratings for the device.

Input and Output Filtering

Filtering at the input or output may be required for several different reasons. In this section we will discuss the main considerations with regards to these filter circuits.

In some applications, the current being measured may be inherently noisy. In the case of a noisy signal, filtering after the output of the current sense amplifier is often simpler, especially where the amplifier output is fed into high impedance circuitry. The amplifier output node provides the greatest freedom when selecting components for the filter and is very straightforward to implement, although it may require subsequent buffering.

Other applications may require filtering at the input of the current sense amplifier. Figure 33 shows the recommended schematic for input filtering.



Figure 33. Input filtering compensates for shunt inductance on shunts less than 1 mΩ, as well as high frequency noise in any application

Input filtering is complicated by the fact that the added resistance of the filter resistors and the associated resistance mismatch between them can adversely affect gain, CMRR, and V_{OS} . The effect on V_{OS} is partly due to input bias currents as well. As a result, the value of the input resistors should be limited to 10 Ω or less. Ideally, select the capacitor to exactly match the time constant of the shunt resistor and its inductance; alternatively, select the capacitor to provide a pole below that point. As an example, a filtering frequency of 100 kHz would require an 80 nF capacitor. The capacitor can have a low voltage rating, but should have good high frequency characteristics.

Make the input filter time constant equal to or larger than the shunt and its inductance time constant:

$$\frac{L_{SHUNT}}{R_{SHUNT}} \leq 2 \cdot R_{FILT} \cdot C_{FILT}$$

This simplifies to determine the value of C_{FILT} based on using 10 Ω resistors for each R_{FILT} :

$$C_{FILT} \geq \frac{L_{SHUNT}}{20R_{SHUNT}}$$

If the main purpose is to filter high frequency noise, the capacitor should be increased to a value that provides the desired filtering.

As the shunt resistors decrease in value, shunt inductance can significantly affect frequency response. At values below 1 mΩ, the shunt inductance causes a zero in the transfer function that often results in corner frequencies in the low 100's of kHz. This inductance increases the amplitude of

high frequency spike transient events on the current sensing line that can overload the front end of any shunt current sensing IC. This problem must be solved by filtering at the input of the amplifier. Note that all current sensing IC's are vulnerable to this problem, regardless of manufacturer claims. Filtering is required at the input of the device to resolve this problem, even if the spike frequencies are above the rated bandwidth of the device.

Advantages When Used for Low-Side Current Sensing

The NCS21xR series offer many advantages for low-side current sensing. The true differential input is ideal for connection to either Kelvin Sensing shunts or conventional shunts. Additionally, the true differential input rejects the common-mode noise often present even in low-side current sensing. The NCS21xR also provides a reference pin to set the output offset from an external reference. Providing all of these features in a tiny package makes the NCS21xR very competitive when compared to discrete op amp solutions.

Designing for Input Transients Exceeding 30 Volts

For applications that have transient common-mode voltages greater than 30 volts, external input resistors of 10 Ω provide a convenient location to add either Zener diodes or transient voltage suppression diodes (also known as TVS diodes). There are two possible configurations: one using a single TVS diode with diodes across the amplifier inputs as shown in Figure 34, and the second configuration using two TVS diodes as shown in Figure 35.



Figure 34. Single TVS transient common-mode protection



Figure 35. Dual TVS Transient Common-mode Protection

Use Zener diodes or unidirectional TVS diodes with clamping voltage ratings up to a maximum of 30 volts. Select TVS diodes with the lowest voltage rating possible for use in the system. There is a wide range between standoff voltage and maximum clamping voltage in TVS diodes. Most diodes rated at a standoff voltage of 18 V have a maximum clamping voltage of 29.2 V. Refer to the TVS data sheet and the parameters of your power supply to make the selection. In general, higher power TVS diodes demonstrate a sharper clamping knee; providing a tighter relationship between rated breakdown and maximum clamping voltage.

Selecting the Shunt Resistor

The desired accuracy of the current measurement determines the precision, shunt size, and the resistor value. The larger the resistor value, the more accurate the measurement possible, but a large resistor value also results in greater current loss.

For the most accurate measurements, use four terminal current sense resistors, as shown in Figure 36. It provides two terminals for the current path in the application circuit, and a second pair for the voltage detection path of the sense amplifier. This technique is also known as *Kelvin Sensing*. This insures that the voltage measured by the sense amplifier is the actual voltage across the resistor and does not include the small resistance of a combined connection. When using non-Kelvin shunts, follow manufacturer recommendations on how to lay out the sensing traces closely.



Figure 36. Surface Mount Kelvin Shunt

Current Output Configuration

In applications where the readout boards are remotely located, the voltage output of the NCS21xR can be converted to a precision current output. The precision output current measurements are read more accurately as it overcomes the errors due to ground drops between the boards.



Figure 37. Remote Current Sensing

As shown in Figure 37, the R_{IOUT} resistor is added between the OUT pin and the REF pin to convert the voltage output to a current output which is taken from the REF pin to the readout board. This circuit is intended to function with low potentials between the boards due to ground drops or noise. The current output is simply the relationship of the normal output voltage of the NCS21xR:

$$I_{OUT} = \frac{V_{OUT}}{R_{IOUT}}$$

A resistor value of 1 kΩ for R_{IOUT} is always a convenient value as it provides 1 mA/V scaling.

On the readout board, for simplicity, R_{ITOV} can be equal to R_{IOUT} to provide identical voltage drops across both. It is important to take into consideration that R_{ITOV} and R_{IOUT} add additional voltage drops in the current measurement path. The current source can provide enough compliance to

overcome most ground voltage drop, stray voltages, and noise. However, accuracy will degrade if noise or ground drops exceed 1 V.

Shutting Down the NCS21xR

While the NCS21xR does not provide a shutdown pin, a simple MOSFET, power switch, or logic gate can be used to switch off the power to the NCS21xR and eliminate the quiescent current. Note that the shunt input pins will always have a current flow via the input and feedback resistors (total resistance of each leg always equals slightly higher than 1 MΩ). Also note that when powered, the shunt input pins will exhibit the specified and well-matched typical bias current of 39 μA. The shunt input pins support the rated common mode voltage even when the NCS21xR does not have power applied.

MECHANICAL CASE OUTLINE PACKAGE DIMENSIONS

ON Semiconductor®



1
SCALE 2:1

SC-88/SC70-6/SOT-363
CASE 419B-02
ISSUE Y

DATE 11 DEC 2012

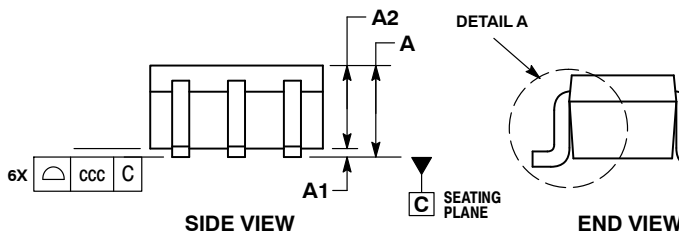

- NOTES:
1. DIMENSIONING AND TOLERANCING PER ASME Y14.5M, 1994.
 2. CONTROLLING DIMENSION: MILLIMETERS.
 3. DIMENSIONS D AND E1 DO NOT INCLUDE MOLD FLASH, PROTRUSIONS, OR GATE BURRS. MOLD FLASH, PROTRUSIONS, OR GATE BURRS SHALL NOT EXCEED 0.20 PER END.
 4. DIMENSIONS D AND E1 AT THE OUTERMOST EXTREMES OF THE PLASTIC BODY AND DATUM H.
 5. DATUMS A AND B ARE DETERMINED AT DATUM H.
 6. DIMENSIONS b AND c APPLY TO THE FLAT SECTION OF THE LEAD BETWEEN 0.08 AND 0.15 FROM THE TIP.
 7. DIMENSION b DOES NOT INCLUDE DAMBAR PROTRUSION. ALLOWABLE DAMBAR PROTRUSION SHALL BE 0.08 TOTAL IN EXCESS OF DIMENSION b AT MAXIMUM MATERIAL CONDITION. THE DAMBAR CANNOT BE LOCATED ON THE LOWER RADIUS OF THE FOOT.

DIM	MILLIMETERS			INCHES		
	MIN	NOM	MAX	MIN	NOM	MAX
A	---	---	1.10	---	---	0.043
A1	0.00	---	0.10	0.000	---	0.004
A2	0.70	0.90	1.00	0.027	0.035	0.039
b	0.15	0.20	0.25	0.006	0.008	0.010
C	0.08	0.15	0.22	0.003	0.006	0.009
D	1.80	2.00	2.20	0.070	0.078	0.086
E	2.00	2.10	2.20	0.078	0.082	0.086
E1	1.15	1.25	1.35	0.045	0.049	0.053
e	0.65 BSC			0.026 BSC		
L	0.26	0.36	0.46	0.010	0.014	0.018
L2	0.15 BSC			0.006 BSC		
aaa	0.15			0.006		
bbb	0.30			0.012		
ccc	0.10			0.004		
ddd	0.10			0.004		

GENERIC MARKING DIAGRAM*

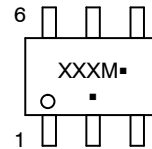

- XXX = Specific Device Code
- M = Date Code*
- = Pb-Free Package

(Note: Microdot may be in either location)

*Date Code orientation and/or position may vary depending upon manufacturing location.

*This information is generic. Please refer to device data sheet for actual part marking. Pb-Free indicator, "G" or microdot "▪", may or may not be present.

RECOMMENDED SOLDERING FOOTPRINT*



*For additional information on our Pb-Free strategy and soldering details, please download the ON Semiconductor Soldering and Mounting Techniques Reference Manual, SOLDERRM/D.

STYLES ON PAGE 2

DOCUMENT NUMBER:	98ASB42985B	Electronic versions are uncontrolled except when accessed directly from the Document Repository. Printed versions are uncontrolled except when stamped "CONTROLLED COPY" in red.
STATUS:	ON SEMICONDUCTOR STANDARD	
NEW STANDARD:		
DESCRIPTION:	SC-88/SC70-6/SOT-363	PAGE 1 OF 3

SC-88/SC70-6/SOT-363
CASE 419B-02
ISSUE Y

DATE 11 DEC 2012

- | | | | | | |
|---|---|--|--|--|--|
| <p>STYLE 1:
 PIN 1. EMITTER 2
 2. BASE 2
 3. COLLECTOR 1
 4. EMITTER 1
 5. BASE 1
 6. COLLECTOR 2</p> | <p>STYLE 2:
 CANCELLED</p> | <p>STYLE 3:
 CANCELLED</p> | <p>STYLE 4:
 PIN 1. CATHODE
 2. CATHODE
 3. COLLECTOR
 4. EMITTER
 5. BASE
 6. ANODE</p> | <p>STYLE 5:
 PIN 1. ANODE
 2. ANODE
 3. COLLECTOR
 4. EMITTER
 5. BASE
 6. CATHODE</p> | <p>STYLE 6:
 PIN 1. ANODE 2
 2. N/C
 3. CATHODE 1
 4. ANODE 1
 5. N/C
 6. CATHODE 2</p> |
| <p>STYLE 7:
 PIN 1. SOURCE 2
 2. DRAIN 2
 3. GATE 1
 4. SOURCE 1
 5. DRAIN 1
 6. GATE 2</p> | <p>STYLE 8:
 CANCELLED</p> | <p>STYLE 9:
 PIN 1. EMITTER 2
 2. EMITTER 1
 3. COLLECTOR 1
 4. BASE 1
 5. BASE 2
 6. COLLECTOR 2</p> | <p>STYLE 10:
 PIN 1. SOURCE 2
 2. SOURCE 1
 3. GATE 1
 4. DRAIN 1
 5. DRAIN 2
 6. GATE 2</p> | <p>STYLE 11:
 PIN 1. CATHODE 2
 2. CATHODE 2
 3. ANODE 1
 4. CATHODE 1
 5. CATHODE 1
 6. ANODE 2</p> | <p>STYLE 12:
 PIN 1. ANODE 2
 2. ANODE 2
 3. CATHODE 1
 4. ANODE 1
 5. ANODE 1
 6. CATHODE 2</p> |
| <p>STYLE 13:
 PIN 1. ANODE
 2. N/C
 3. COLLECTOR
 4. EMITTER
 5. BASE
 6. CATHODE</p> | <p>STYLE 14:
 PIN 1. VREF
 2. GND
 3. GND
 4. IOUT
 5. VEN
 6. VCC</p> | <p>STYLE 15:
 PIN 1. ANODE 1
 2. ANODE 2
 3. ANODE 3
 4. CATHODE 3
 5. CATHODE 2
 6. CATHODE 1</p> | <p>STYLE 16:
 PIN 1. BASE 1
 2. EMITTER 2
 3. COLLECTOR 2
 4. BASE 2
 5. EMITTER 1
 6. COLLECTOR 1</p> | <p>STYLE 17:
 PIN 1. BASE 1
 2. EMITTER 1
 3. COLLECTOR 2
 4. BASE 2
 5. EMITTER 2
 6. COLLECTOR 1</p> | <p>STYLE 18:
 PIN 1. VIN1
 2. VCC
 3. VOUT2
 4. VIN2
 5. GND
 6. VOUT1</p> |
| <p>STYLE 19:
 PIN 1. IOUT
 2. GND
 3. GND
 4. V CC
 5. V EN
 6. V REF</p> | <p>STYLE 20:
 PIN 1. COLLECTOR
 2. COLLECTOR
 3. BASE
 4. EMITTER
 5. COLLECTOR
 6. COLLECTOR</p> | <p>STYLE 21:
 PIN 1. ANODE 1
 2. N/C
 3. ANODE 2
 4. CATHODE 2
 5. N/C
 6. CATHODE 1</p> | <p>STYLE 22:
 PIN 1. D1 (i)
 2. GND
 3. D2 (j)
 4. D2 (c)
 5. VBUS
 6. D1 (c)</p> | <p>STYLE 23:
 PIN 1. Vn
 2. CH1
 3. Vp
 4. N/C
 5. CH2
 6. N/C</p> | <p>STYLE 24:
 PIN 1. CATHODE
 2. ANODE
 3. CATHODE
 4. CATHODE
 5. CATHODE
 6. CATHODE</p> |
| <p>STYLE 25:
 PIN 1. BASE 1
 2. CATHODE
 3. COLLECTOR 2
 4. BASE 2
 5. EMITTER
 6. COLLECTOR 1</p> | <p>STYLE 26:
 PIN 1. SOURCE 1
 2. GATE 1
 3. DRAIN 2
 4. SOURCE 2
 5. GATE 2
 6. DRAIN 1</p> | <p>STYLE 27:
 PIN 1. BASE 2
 2. BASE 1
 3. COLLECTOR 1
 4. EMITTER 1
 5. EMITTER 2
 6. COLLECTOR 2</p> | <p>STYLE 28:
 PIN 1. DRAIN
 2. DRAIN
 3. GATE
 4. SOURCE
 5. DRAIN
 6. DRAIN</p> | <p>STYLE 29:
 PIN 1. ANODE
 2. ANODE
 3. COLLECTOR
 4. EMITTER
 5. BASE/ANODE
 6. CATHODE</p> | <p>STYLE 30:
 PIN 1. SOURCE 1
 2. DRAIN 2
 3. DRAIN 2
 4. SOURCE 2
 5. GATE 1
 6. DRAIN 1</p> |

DOCUMENT NUMBER:	98ASB42985B	Electronic versions are uncontrolled except when accessed directly from the Document Repository. Printed versions are uncontrolled except when stamped "CONTROLLED COPY" in red.
STATUS:	ON SEMICONDUCTOR STANDARD	
NEW STANDARD:		
DESCRIPTION:	SC-88/SC-70/SOT-363	PAGE 2 OF 3



ISSUE	REVISION	DATE
H	REVISION TO CHANGE LEGAL OWNER OF DOCUMENT FROM MOTOROLA TO ON SEMICONDUCTOR. DELETED DIM "V" WAS 0.3 MM-0.4 MM/0.012-0.016 IN. REQ BY G KWONG	14 JUN 01
J	ADDED STYLE 20. REQ BY M. ATANOVICH.	11 OCT 01
K	UPDATED STYLE 15 WAS PIN 1, 2 AND 3: ANODE. PIN 4, 5, AND 6 CATHODE. ADDED STYLE 21. REQ BY M. ATANOVICH	03 APR 02
L	ADDED STYLE 22. REQ BY S. CHANG	25 OCT 02
M	ADDED STYLE 23. REQ BY B. BLACKMON	04 DEC 02
N	ADDED STYLE 24. REQ BY B. BLACKMON	09 JAN 03
P	ADDED STYLE 25. REQ BY S. CHANG	09 MAY 03
R	REMOVED THE "1" AFTER EMITTER. REQ BY S. CHANG	03 JUN 03
S	ADDED STYLE 26. REQ BY A. BINEYARD	18 AUG 03
T	ADDED STYLE 27. REQ. BY M. SWEADOR	23 OCT 2003
U	ADDED STYLES 28 AND 29. REQ. BY A. BINEYARD AND S. BACHMAN	22 JAN 2004
V	ADDED NOM VALUES AND CHANGED DIMS TO INDUSTRY STANDARD. REQ. BY D. TRUHITTE	31 JAN 2005
W	ADDED STYLE 30. REQ. BY L. DELUCA.	26 JAN 2006
Y	UPDATED & REDREW TO JEDEC STANDARDS. REQ. BY D. TRUHITTE.	11 DEC 2012

ON Semiconductor and  are registered trademarks of Semiconductor Components Industries, LLC (SCILLC). SCILLC reserves the right to make changes without further notice to any products herein. SCILLC makes no warranty, representation or guarantee regarding the suitability of its products for any particular purpose, nor does SCILLC assume any liability arising out of the application or use of any product or circuit, and specifically disclaims any and all liability, including without limitation special, consequential or incidental damages. "Typical" parameters which may be provided in SCILLC data sheets and/or specifications can and do vary in different applications and actual performance may vary over time. All operating parameters, including "Typicals" must be validated for each customer application by customer's technical experts. SCILLC does not convey any license under its patent rights nor the rights of others. SCILLC products are not designed, intended, or authorized for use as components in systems intended for surgical implant into the body, or other applications intended to support or sustain life, or for any other application in which the failure of the SCILLC product could create a situation where personal injury or death may occur. Should Buyer purchase or use SCILLC products for any such unintended or unauthorized application, Buyer shall indemnify and hold SCILLC and its officers, employees, subsidiaries, affiliates, and distributors harmless against all claims, costs, damages, and expenses, and reasonable attorney fees arising out of, directly or indirectly, any claim of personal injury or death associated with such unintended or unauthorized use, even if such claim alleges that SCILLC was negligent regarding the design or manufacture of the part. SCILLC is an Equal Opportunity/Affirmative Action Employer. This literature is subject to all applicable copyright laws and is not for resale in any manner.

MECHANICAL CASE OUTLINE

PACKAGE DIMENSIONS

ON Semiconductor®



UQFN10 1.4x1.8, 0.4P

CASE 488AT-01
ISSUE A

DATE 01 AUG 2007



SCALE 5:1

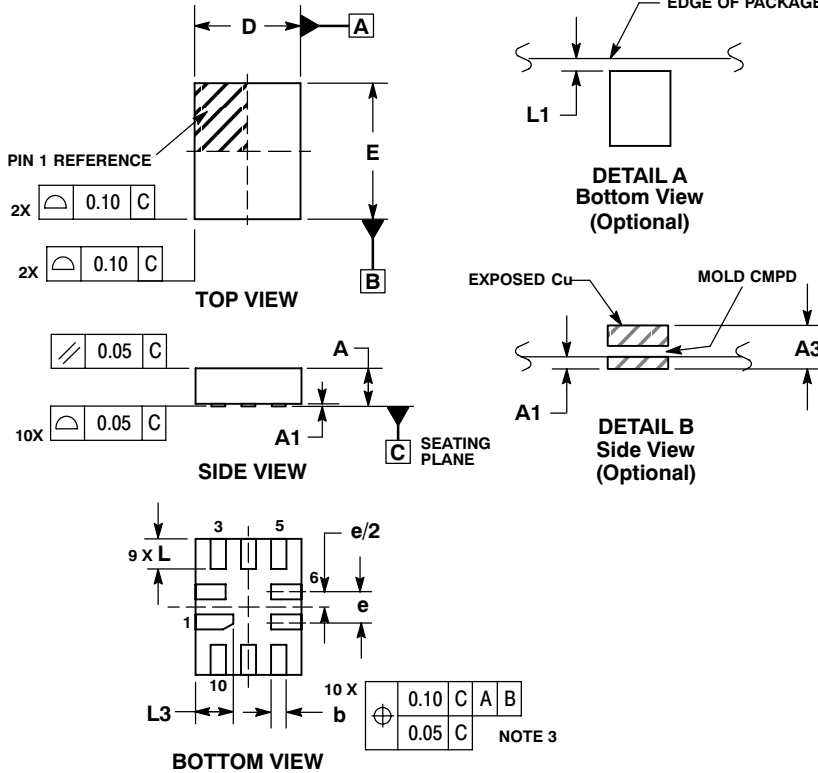

NOTES:

- DIMENSIONING AND TOLERANCING PER ASME Y14.5M, 1994.
- CONTROLLING DIMENSION: MILLIMETERS
- DIMENSION b APPLIES TO PLATED TERMINAL AND IS MEASURED BETWEEN 0.25 AND 0.30 MM FROM TERMINAL.
- COPLANARITY APPLIES TO THE EXPOSED PAD AS WELL AS THE TERMINALS.

DIM	MILLIMETERS	
	MIN	MAX
A	0.45	0.60
A1	0.00	0.05
A3	0.127 REF	
b	0.15	0.25
D	1.40	BSC
E	1.80	BSC
e	0.40	BSC
L	0.30	0.50
L1	0.00	0.15
L3	0.40	0.60

GENERIC MARKING DIAGRAM*

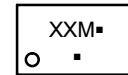

- XX = Specific Device Code
- M = Date Code
- = Pb-Free Package

(Note: Microdot may be in either location)

*This information is generic. Please refer to device data sheet for actual part marking. Pb-Free indicator, "G" or microdot "▪", may or may not be present.

MOUNTING FOOTPRINT

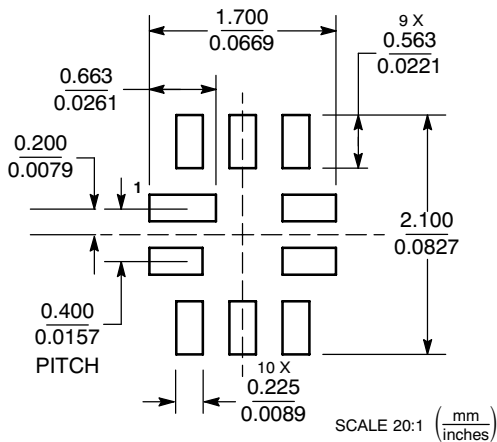

DOCUMENT NUMBER:	98AON22493D	Electronic versions are uncontrolled except when accessed directly from the Document Repository. Printed versions are uncontrolled except when stamped "CONTROLLED COPY" in red.
STATUS:	ON SEMICONDUCTOR STANDARD	
NEW STANDARD:		
DESCRIPTION:	10 PIN UQFN, 1.4 X 1.8, 0.4P	PAGE 1 OF 2



ISSUE	REVISION	DATE
O	RELEASED FOR PRODUCTION. REQ. BY E SOTO.	28 APR 2006
A	ADDED DETAILS A AND B. REQ. BY E. SOTO.	01 AUG 2007

ON Semiconductor and ON are registered trademarks of Semiconductor Components Industries, LLC (SCILLC). SCILLC reserves the right to make changes without further notice to any products herein. SCILLC makes no warranty, representation or guarantee regarding the suitability of its products for any particular purpose, nor does SCILLC assume any liability arising out of the application or use of any product or circuit, and specifically disclaims any and all liability, including without limitation special, consequential or incidental damages. "Typical" parameters which may be provided in SCILLC data sheets and/or specifications can and do vary in different applications and actual performance may vary over time. All operating parameters, including "Typicals" must be validated for each customer application by customer's technical experts. SCILLC does not convey any license under its patent rights nor the rights of others. SCILLC products are not designed, intended, or authorized for use as components in systems intended for surgical implant into the body, or other applications intended to support or sustain life, or for any other application in which the failure of the SCILLC product could create a situation where personal injury or death may occur. Should Buyer purchase or use SCILLC products for any such unintended or unauthorized application, Buyer shall indemnify and hold SCILLC and its officers, employees, subsidiaries, affiliates, and distributors harmless against all claims, costs, damages, and expenses, and reasonable attorney fees arising out of, directly or indirectly, any claim of personal injury or death associated with such unintended or unauthorized use, even if such claim alleges that SCILLC was negligent regarding the design or manufacture of the part. SCILLC is an Equal Opportunity/Affirmative Action Employer. This literature is subject to all applicable copyright laws and is not for resale in any manner.

ON Semiconductor and  are trademarks of Semiconductor Components Industries, LLC dba ON Semiconductor or its subsidiaries in the United States and/or other countries. ON Semiconductor owns the rights to a number of patents, trademarks, copyrights, trade secrets, and other intellectual property. A listing of ON Semiconductor's product/patent coverage may be accessed at www.onsemi.com/site/pdf/Patent-Marking.pdf. ON Semiconductor reserves the right to make changes without further notice to any products herein. ON Semiconductor makes no warranty, representation or guarantee regarding the suitability of its products for any particular purpose, nor does ON Semiconductor assume any liability arising out of the application or use of any product or circuit, and specifically disclaims any and all liability, including without limitation special, consequential or incidental damages. Buyer is responsible for its products and applications using ON Semiconductor products, including compliance with all laws, regulations and safety requirements or standards, regardless of any support or applications information provided by ON Semiconductor. "Typical" parameters which may be provided in ON Semiconductor data sheets and/or specifications can and do vary in different applications and actual performance may vary over time. All operating parameters, including "Typicals" must be validated for each customer application by customer's technical experts. ON Semiconductor does not convey any license under its patent rights nor the rights of others. ON Semiconductor products are not designed, intended, or authorized for use as a critical component in life support systems or any FDA Class 3 medical devices or medical devices with a same or similar classification in a foreign jurisdiction or any devices intended for implantation in the human body. Should Buyer purchase or use ON Semiconductor products for any such unintended or unauthorized application, Buyer shall indemnify and hold ON Semiconductor and its officers, employees, subsidiaries, affiliates, and distributors harmless against all claims, costs, damages, and expenses, and reasonable attorney fees arising out of, directly or indirectly, any claim of personal injury or death associated with such unintended or unauthorized use, even if such claim alleges that ON Semiconductor was negligent regarding the design or manufacture of the part. ON Semiconductor is an Equal Opportunity/Affirmative Action Employer. This literature is subject to all applicable copyright laws and is not for resale in any manner.

PUBLICATION ORDERING INFORMATION

LITERATURE FULFILLMENT:

Literature Distribution Center for ON Semiconductor
19521 E. 32nd Pkwy, Aurora, Colorado 80011 USA
Phone: 303-675-2175 or 800-344-3860 Toll Free USA/Canada
Fax: 303-675-2176 or 800-344-3867 Toll Free USA/Canada
Email: orderlit@onsemi.com

N. American Technical Support: 800-282-9855 Toll Free
USA/Canada
Europe, Middle East and Africa Technical Support:
Phone: 421 33 790 2910

ON Semiconductor Website: www.onsemi.com

Order Literature: <http://www.onsemi.com/orderlit>

For additional information, please contact your local
Sales Representative



Компания «ЭлектроПласт» предлагает заключение долгосрочных отношений при поставках импортных электронных компонентов на взаимовыгодных условиях!

Наши преимущества:

- Оперативные поставки широкого спектра электронных компонентов отечественного и импортного производства напрямую от производителей и с крупнейших мировых складов;
- Поставка более 17-ти миллионов наименований электронных компонентов;
- Поставка сложных, дефицитных, либо снятых с производства позиций;
- Оперативные сроки поставки под заказ (от 5 рабочих дней);
- Экспресс доставка в любую точку России;
- Техническая поддержка проекта, помощь в подборе аналогов, поставка прототипов;
- Система менеджмента качества сертифицирована по Международному стандарту ISO 9001;
- Лицензия ФСБ на осуществление работ с использованием сведений, составляющих государственную тайну;
- Поставка специализированных компонентов (Xilinx, Altera, Analog Devices, Intersil, Interpoint, Microsemi, Aeroflex, Peregrine, Syfer, Eurofarad, Texas Instrument, Miteq, Cobham, E2V, MA-COM, Hittite, Mini-Circuits, General Dynamics и др.);

Помимо этого, одним из направлений компании «ЭлектроПласт» является направление «Источники питания». Мы предлагаем Вам помощь Конструкторского отдела:

- Подбор оптимального решения, техническое обоснование при выборе компонента;
- Подбор аналогов;
- Консультации по применению компонента;
- Поставка образцов и прототипов;
- Техническая поддержка проекта;
- Защита от снятия компонента с производства.



Как с нами связаться

Телефон: 8 (812) 309 58 32 (многоканальный)

Факс: 8 (812) 320-02-42

Электронная почта: org@eplast1.ru

Адрес: 198099, г. Санкт-Петербург, ул. Калинина, дом 2, корпус 4, литера А.