

THIS DRAWING IS UNPUBLISHED. RELEASED FOR PUBLICATION
 © COPYRIGHT BY TYCO ELECTRONICS CORPORATION. ALL RIGHTS RESERVED.

| LOC | | DIST | | REVISIONS | | | |
|-----|-----|-----------------------------|---------|-----------|----|--|--|
| P | LTR | DATE | DWN | APVD | | | |
| AD | 00 | | | | | | |
| | H | REVISED PER EC 0512-0273-05 | 19SEP05 | JDP | DD | | |

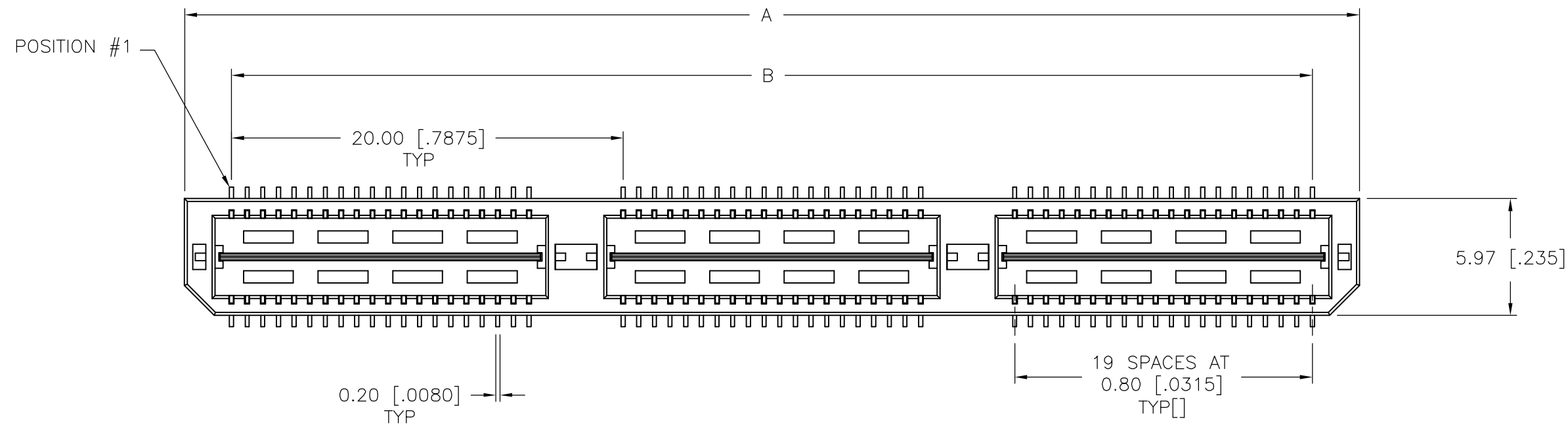

- 1 HOUSING: LCP, BLACK.
CONTACT & GROUND PLANE: PHOS BRONZE.
- 2 CONTACT PLATING: SELECT 0.25 MICROMETERS (.000010 IN.) MIN. GOLD.
- 3 FOR STANDARD APPLICATIONS, ORIENTATION HOLE TO BE $\phi 1.02$ [$\phi.0400$].

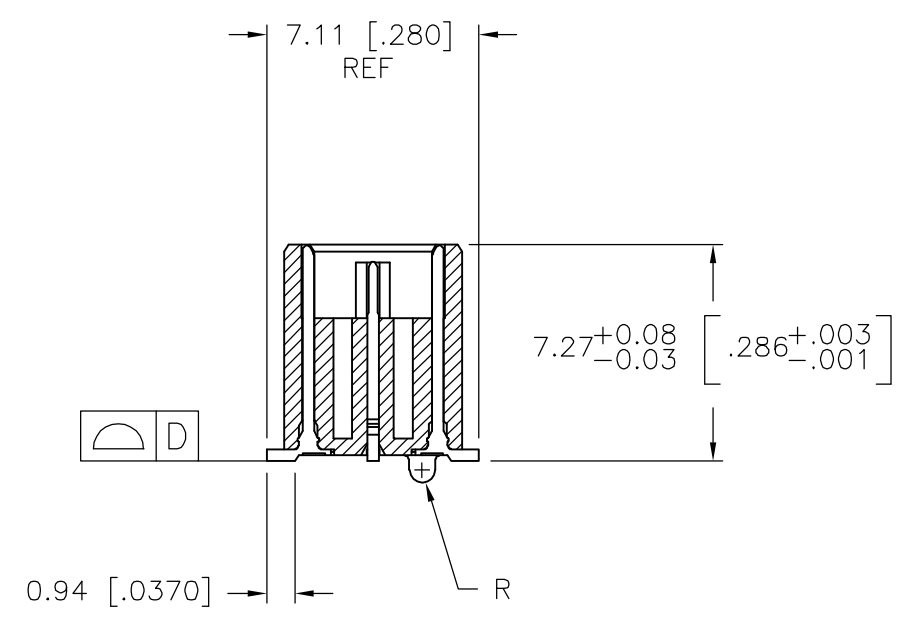
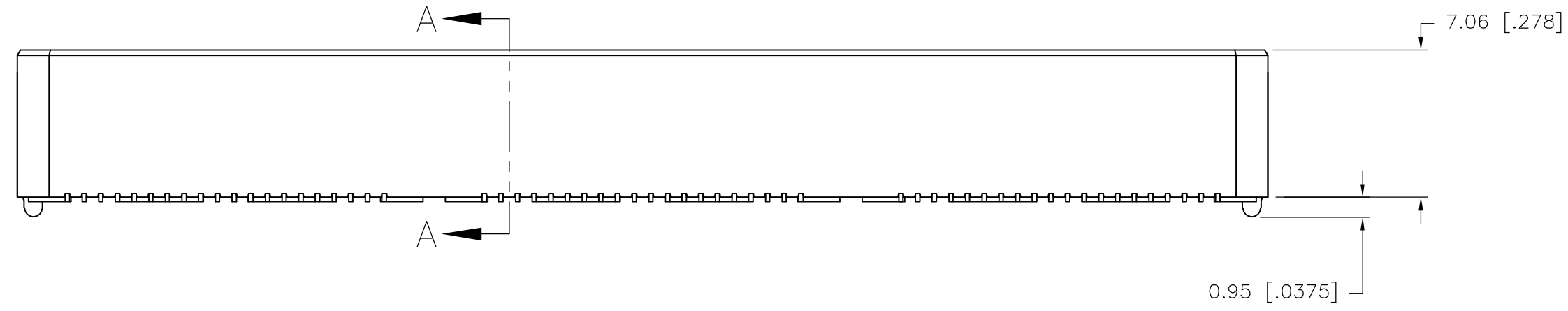

SECTION A-A

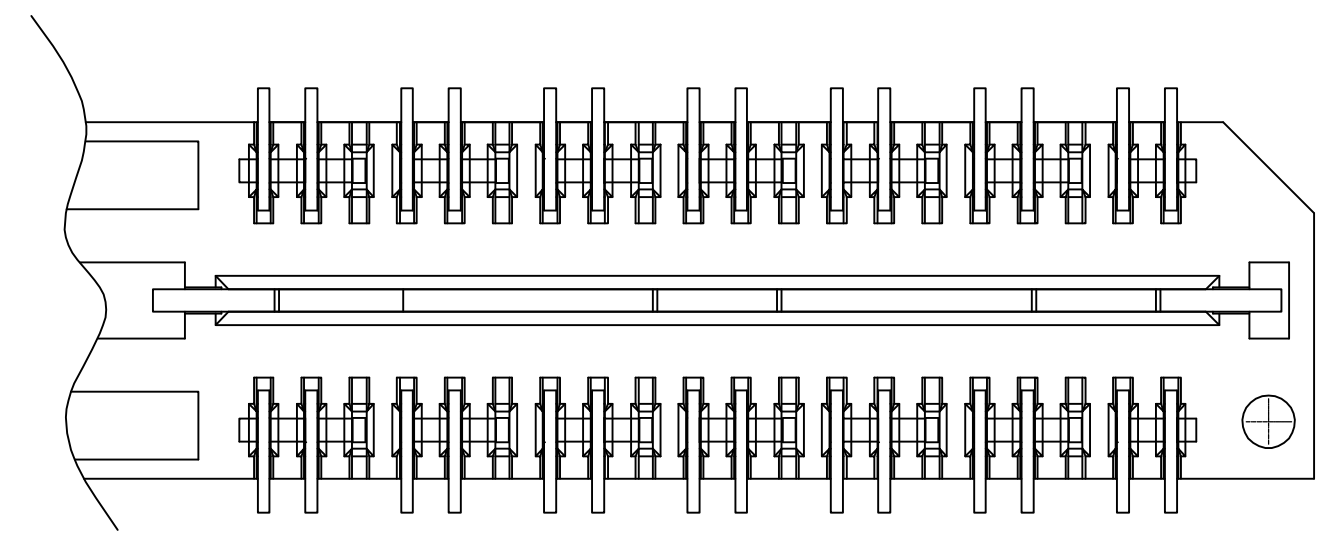
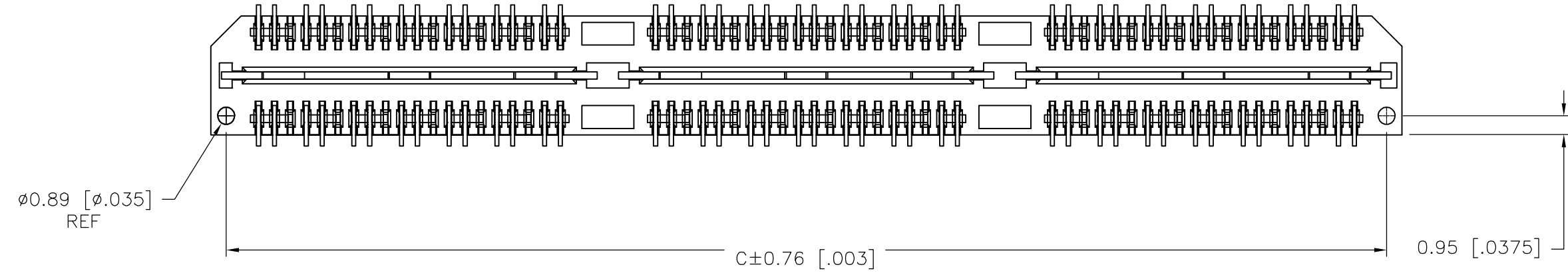

DIFFERENTIAL PAIR LOADING
(BOTTOM VIEW)
SCALE 2:1

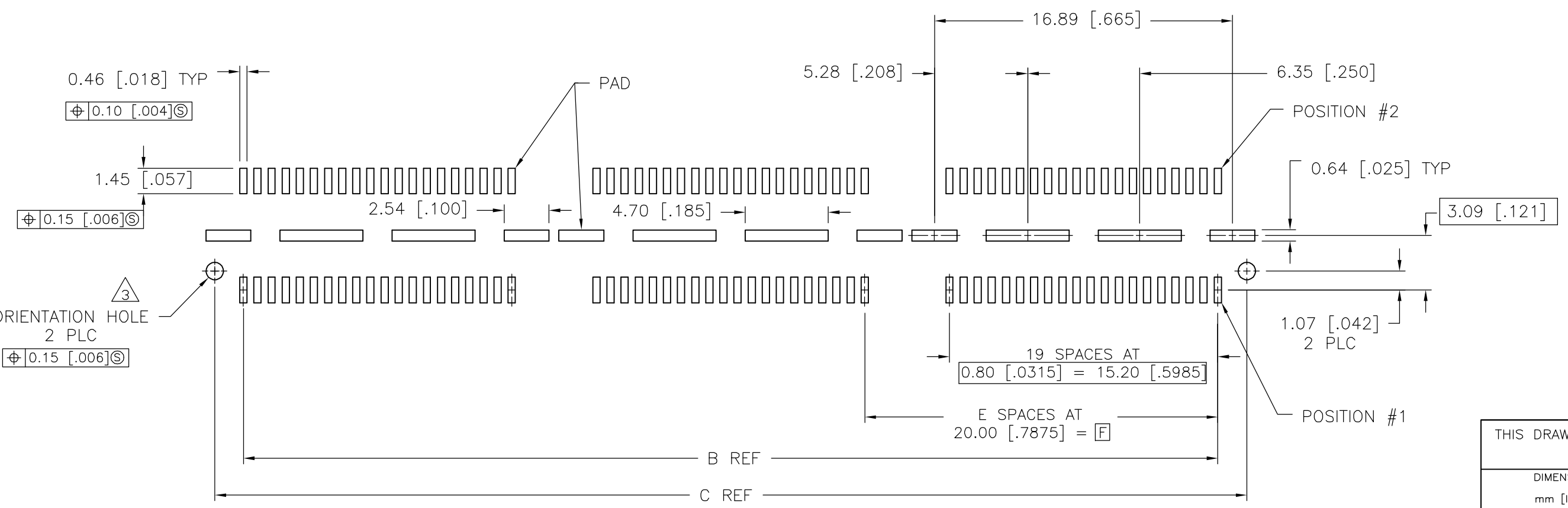

RECOMMENDED PC BOARD LAYOUT
(VIEWED FROM CONNECTOR SIDE)

| | | | | |
|--|--|----------------------|--|-----------------|
| THIS DRAWING IS A CONTROLLED DOCUMENT. | | DWN B.CARBO 30JAN03 | Tyco Electronics Corporation Harrisburg, PA 17105-3608 | |
| DIMENSIONS: mm [INCHES] | | CHK D.DIXON 30JAN03 | | |
| TOLERANCES UNLESS OTHERWISE SPECIFIED: | | APVD D.DIXON 30JAN03 | NAME | |
| 0 PLC ± - | | PRODUCT SPEC | HEADER ASSEMBLY, 8.0MM [.315] VERTICAL, 0.80MM CL, MICTOR SB | |
| 1 PLC ± 0.3[.01] | | APPLICATION SPEC | SIZE A2 | CAGE CODE 00779 |
| 2 PLC ± 0.13[.005] | | | DRAWING NO C=1658014 | RESTRICTED TO |
| 3 PLC ± 0.05[.0020] | | | SCALE 3:1 | SHEET 1 of 2 |
| 4 PLC ± - | | | | REV H |
| ANGLES ± 2° | | | | |
| FINISH | | | | |

THIS DRAWING IS UNPUBLISHED. RELEASED FOR PUBLICATION
 © COPYRIGHT BY TYCO ELECTRONICS CORPORATION. ALL RIGHTS RESERVED.

| LOC | DIST | REVISIONS | | | |
|-----|------|-------------|------|-----|------|
| P | LTR | DESCRIPTION | DATE | DWN | APVD |
| AD | 00 | SEE SHEET 1 | - | - | - |

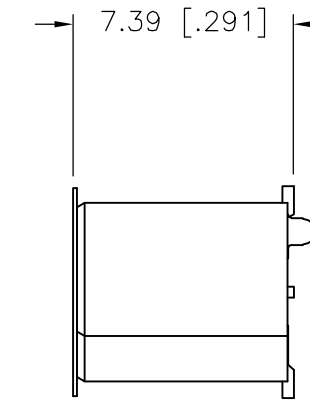
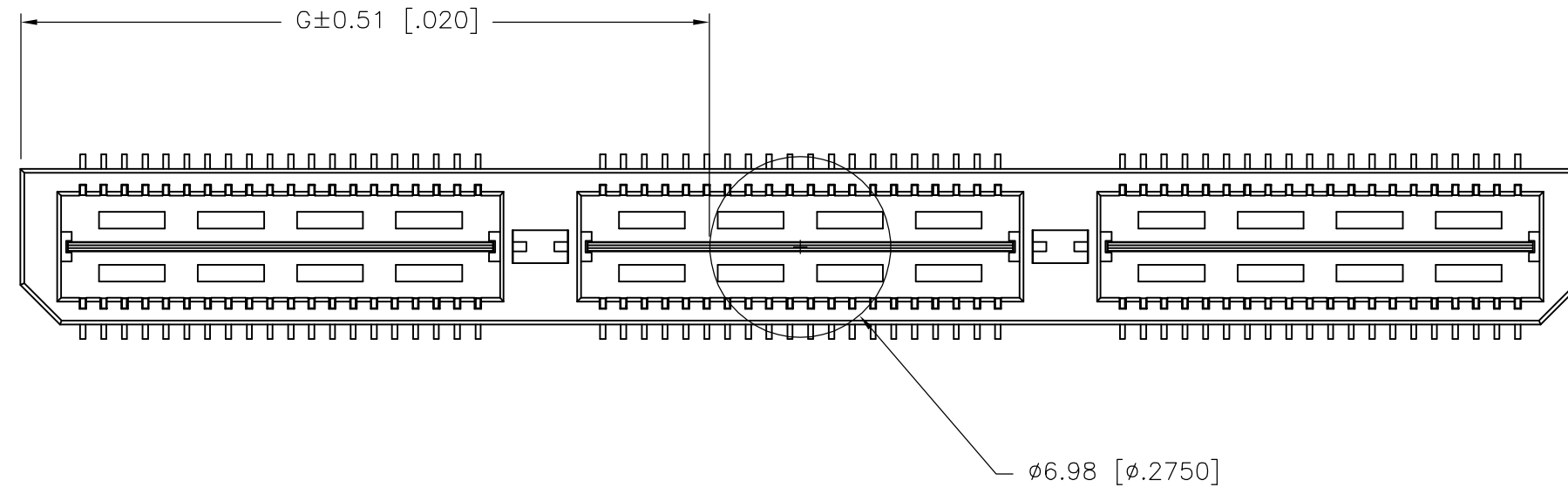

| G | F | E | D | C | B | A | POLYIMIDE FILM PAD ▲ | PACKAGING TYPE | DIFF. PAIR | NO OF POS | PART NUMBER |
|--------------|--------------|---|--------------|--------------|--------------|---------------|----------------------|----------------|------------|-----------|-------------|
| 26.52(1.044) | 40.00(1.575) | 2 | 0.102(.0040) | 58.50(2.303) | 55.20(2.173) | 60.00(2.362) | YES | POCKET TAPE | YES | 84 | 7-1658014-3 |
| 16.51(.650) | 20.00(.7874) | 1 | 0.102(.0040) | 38.48(1.515) | 35.20(1.386) | 40.00(1.575) | YES | POCKET TAPE | YES | 56 | 7-1658014-2 |
| 6.50(.256) | 0(.000) | 0 | 0.102(.0040) | 18.49(.728) | 15.20(.598) | 20.00(.787) | YES | POCKET TAPE | YES | 28 | 7-1658014-1 |
| 26.52(1.044) | 40.00(1.575) | 2 | 0.102(.0040) | 58.50(2.303) | 55.20(2.173) | 60.00(2.362) | YES | POCKET TAPE | NO | 120 | 6-1658014-3 |
| 16.51(.650) | 20.00(.7874) | 1 | 0.102(.0040) | 38.48(1.515) | 35.20(1.386) | 40.00(1.575) | YES | POCKET TAPE | NO | 80 | 6-1658014-2 |
| 6.50(.256) | 0(.000) | 0 | 0.102(.0040) | 18.49(.728) | 15.20(.598) | 20.00(.787) | YES | POCKET TAPE | NO | 40 | 6-1658014-1 |
| - | 40.00(1.575) | 2 | 0.102(.0040) | 58.50(2.303) | 55.20(2.173) | 60.00(2.362) | NO | POCKET TAPE | YES | 84 | 5-1658014-3 |
| - | 20.00(.7874) | 1 | 0.102(.0040) | 38.48(1.515) | 35.20(1.386) | 40.00(1.575) | NO | POCKET TAPE | YES | 56 | 5-1658014-2 |
| - | 0(.000) | 0 | 0.102(.0040) | 18.49(.728) | 15.20(.598) | 20.00(.787) | NO | POCKET TAPE | YES | 28 | 5-1658014-1 |
| - | 40.00(1.575) | 2 | 0.102(.0040) | 58.50(2.303) | 55.20(2.173) | 60.00(2.362) | NO | POCKET TAPE | NO | 120 | 4-1658014-3 |
| - | 20.00(.7874) | 1 | 0.102(.0040) | 38.48(1.515) | 35.20(1.386) | 40.00(1.575) | NO | POCKET TAPE | NO | 80 | 4-1658014-2 |
| - | 0(.000) | 0 | 0.102(.0040) | 18.49(.728) | 15.20(.598) | 20.00(.787) | NO | POCKET TAPE | NO | 40 | 4-1658014-1 |
| 46.51(1.831) | 80.00(3.150) | 4 | 0.152(.0060) | 98.50(3.748) | 95.20(3.748) | 100.00(3.937) | YES | TRAY | YES | 140 | 3-1658014-5 |
| 36.53(1.438) | 60.00(2.362) | 3 | 0.152(.0060) | 78.49(3.090) | 75.20(2.961) | 80.00(3.150) | YES | TRAY | YES | 112 | 3-1658014-4 |
| 26.52(1.044) | 40.00(1.575) | 2 | 0.102(.0040) | 58.50(2.303) | 55.20(2.173) | 60.00(2.362) | YES | TRAY | YES | 84 | 3-1658014-3 |
| 16.51(.650) | 20.00(.7874) | 1 | 0.102(.0040) | 38.48(1.515) | 35.20(1.386) | 40.00(1.575) | YES | TRAY | YES | 56 | 3-1658014-2 |
| 6.50(.256) | 0(.000) | 0 | 0.102(.0040) | 18.49(.728) | 15.20(.598) | 20.00(.787) | YES | TRAY | YES | 28 | 3-1658014-1 |
| 46.51(1.831) | 80.00(3.150) | 4 | 0.152(.0060) | 98.50(3.748) | 95.20(3.748) | 100.00(3.937) | YES | TRAY | NO | 200 | 2-1658014-5 |
| 36.53(1.438) | 60.00(2.362) | 3 | 0.152(.0060) | 78.49(3.090) | 75.20(2.961) | 80.00(3.150) | YES | TRAY | NO | 160 | 2-1658014-4 |
| 26.52(1.044) | 40.00(1.575) | 2 | 0.102(.0040) | 58.50(2.303) | 55.20(2.173) | 60.00(2.362) | YES | TRAY | NO | 120 | 2-1658014-3 |
| 16.51(.650) | 20.00(.7874) | 1 | 0.102(.0040) | 38.48(1.515) | 35.20(1.386) | 40.00(1.575) | YES | TRAY | NO | 80 | 2-1658014-2 |
| 6.50(.256) | 0(.000) | 0 | 0.102(.0040) | 18.49(.728) | 15.20(.598) | 20.00(.787) | YES | TRAY | NO | 40 | 2-1658014-1 |
| - | 80.00(3.150) | 4 | 0.152(.0060) | 98.50(3.748) | 95.20(3.748) | 100.00(3.937) | NO | TRAY | YES | 140 | 1-1658014-5 |
| - | 60.00(2.362) | 3 | 0.152(.0060) | 78.49(3.090) | 75.20(2.961) | 80.00(3.150) | NO | TRAY | YES | 112 | 1-1658014-4 |
| - | 40.00(1.575) | 2 | 0.102(.0040) | 58.50(2.303) | 55.20(2.173) | 60.00(2.362) | NO | TRAY | YES | 84 | 1-1658014-3 |
| - | 20.00(.7874) | 1 | 0.102(.0040) | 38.48(1.515) | 35.20(1.386) | 40.00(1.575) | NO | TRAY | YES | 56 | 1-1658014-2 |
| - | 0(.000) | 0 | 0.102(.0040) | 18.49(.728) | 15.20(.598) | 20.00(.787) | NO | TRAY | YES | 28 | 1-1658014-1 |
| - | 80.00(3.150) | 4 | 0.152(.0060) | 98.50(3.748) | 95.20(3.748) | 100.00(3.937) | NO | TRAY | NO | 200 | 1658014-5 |
| - | 60.00(2.362) | 3 | 0.152(.0060) | 78.49(3.090) | 75.20(2.961) | 80.00(3.150) | NO | TRAY | NO | 160 | 1658014-4 |
| - | 40.00(1.575) | 2 | 0.102(.0040) | 58.50(2.303) | 55.20(2.173) | 60.00(2.362) | NO | TRAY | NO | 120 | 1658014-3 |
| - | 20.00(.7874) | 1 | 0.102(.0040) | 38.48(1.515) | 35.20(1.386) | 40.00(1.575) | NO | TRAY | NO | 80 | 1658014-2 |
| - | 0(.000) | 0 | 0.102(.0040) | 18.49(.728) | 15.20(.598) | 20.00(.787) | NO | TRAY | NO | 40 | 1658014-1 |

THIS DRAWING IS A CONTROLLED DOCUMENT.

DWN B.CARRO 30JAN03
 CHK D.DIXON 30JAN03
 APVD D.DIXON 30JAN03

TOLERANCES UNLESS OTHERWISE SPECIFIED:
 0 PLC ± -
 1 PLC ± 0.3[.01]
 2 PLC ± 0.13[.005]
 3 PLC ± 0.05[.0020]
 4 PLC ± -
 ANGLES ± 2°

MATERIAL FINISH SEE SHEET 1

WEIGHT -

CUSTOMER DRAWING

tyco Electronics Tyco Electronics Corporation
 Harrisburg, PA 17105-3608

NAME: HEADER ASSEMBLY, 8.0MM [.315] VERTICAL, 0.80MM CL, MICTOR SB

SIZE: A2 CAGE CODE: 00779 DRAWING NO: C=1658014 RESTRICTED TO: -

SCALE: 3:1 SHEET: 2 of 2 REV: H



Компания «ЭлектроПласт» предлагает заключение долгосрочных отношений при поставках импортных электронных компонентов на взаимовыгодных условиях!

Наши преимущества:

- Оперативные поставки широкого спектра электронных компонентов отечественного и импортного производства напрямую от производителей и с крупнейших мировых складов;
- Поставка более 17-ти миллионов наименований электронных компонентов;
- Поставка сложных, дефицитных, либо снятых с производства позиций;
- Оперативные сроки поставки под заказ (от 5 рабочих дней);
- Экспресс доставка в любую точку России;
- Техническая поддержка проекта, помощь в подборе аналогов, поставка прототипов;
- Система менеджмента качества сертифицирована по Международному стандарту ISO 9001;
- Лицензия ФСБ на осуществление работ с использованием сведений, составляющих государственную тайну;
- Поставка специализированных компонентов (Xilinx, Altera, Analog Devices, Intersil, Interpoint, Microsemi, Aeroflex, Peregrine, Syfer, Eurofarad, Texas Instrument, Miteq, Cobham, E2V, MA-COM, Hittite, Mini-Circuits, General Dynamics и др.);

Помимо этого, одним из направлений компании «ЭлектроПласт» является направление «Источники питания». Мы предлагаем Вам помощь Конструкторского отдела:

- Подбор оптимального решения, техническое обоснование при выборе компонента;
- Подбор аналогов;
- Консультации по применению компонента;
- Поставка образцов и прототипов;
- Техническая поддержка проекта;
- Защита от снятия компонента с производства.



Как с нами связаться

Телефон: 8 (812) 309 58 32 (многоканальный)

Факс: 8 (812) 320-02-42

Электронная почта: org@eplast1.ru

Адрес: 198099, г. Санкт-Петербург, ул. Калинина, дом 2, корпус 4, литера А.