

Specification

Part No.	: LLP.2450.X.A.30
Description	: LTCC Low Pass Filter for 2450MHz Bandwidth 100MHz
Features	: Cutoff Frequency 2450.0 MHz Low Insertion Loss Low Pass Band Ripple High Attenuation Ultra-Compact, Low Profile SMT Package Dims: 1.6 x 0.8 x 0.6mm

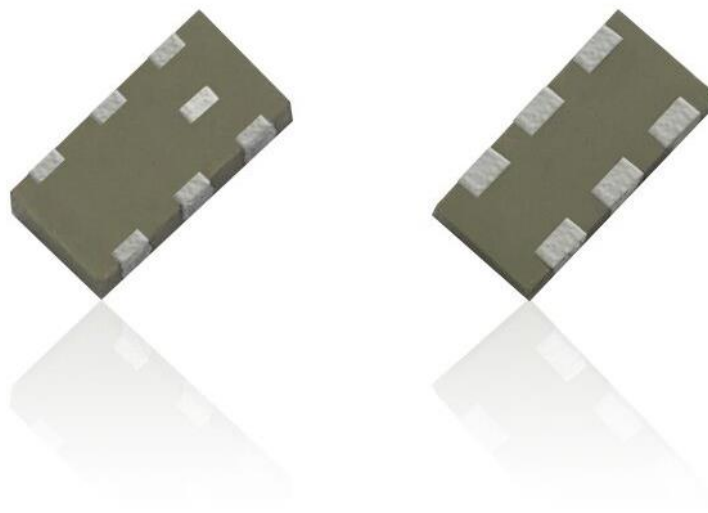

1. Introduction

Taoglas are utilizing their deep understanding of the RF component design and manufacturing process to provide high-quality, small-form-factor, cost-effective and easy to implement RF filters. The Taoglas Filters Division will feature a range of off-the-shelf filters for a variety of applications, including filters for emerging license free bands used for IoT and for GPS L1/L2 and L1/L5 applications. We can also work with customers to develop bespoke filter solutions.

Taoglas LTCC filters are designed to be used in wireless transmitters or receivers. They feature low insertion loss and provide good rejection of unwanted signals at harmonic frequencies for improved system performance. The product is manufactured as a multi-layer monolithic ceramic structure which provides high reliability in a lightweight, low-profile, industrial standard SMT package.

These small part sizes allow for high density PCB layout, provide excellent solderability, and allow for easy visual inspection capability.

The LLP.2450.X.A.30 is a standard Taoglas product but can be customized for specific customer needs. For more information please contact your regional sales office.

2. Specification

Electrical Characteristics	
Cutoff Frequency	2450 MHz
Insertion Loss	0.5 dB max
Passband Ripple	0.5 dB max
Return Loss	< -10 dB
Attenuation	> 35dB @ 4800 MHz ~ 5000 MHz > 24dB @ 5000 MHz ~ 8000 MHz
In/Out Impedance	50 Ω
Power Dissipation	1.0 W min.
MECHANICAL	
Dimension	1.6 x 0.8 x 0.6mm (L x W x H)
Material	Ceramic
Finish	Ag plated
ENVIRONMENTAL	
Operating Temperature	-40°C to 85°C
Storage Temperature	-40°C to 85°C

3. Characteristics Curve

3.1. Pass Band Return & Insertion Loss

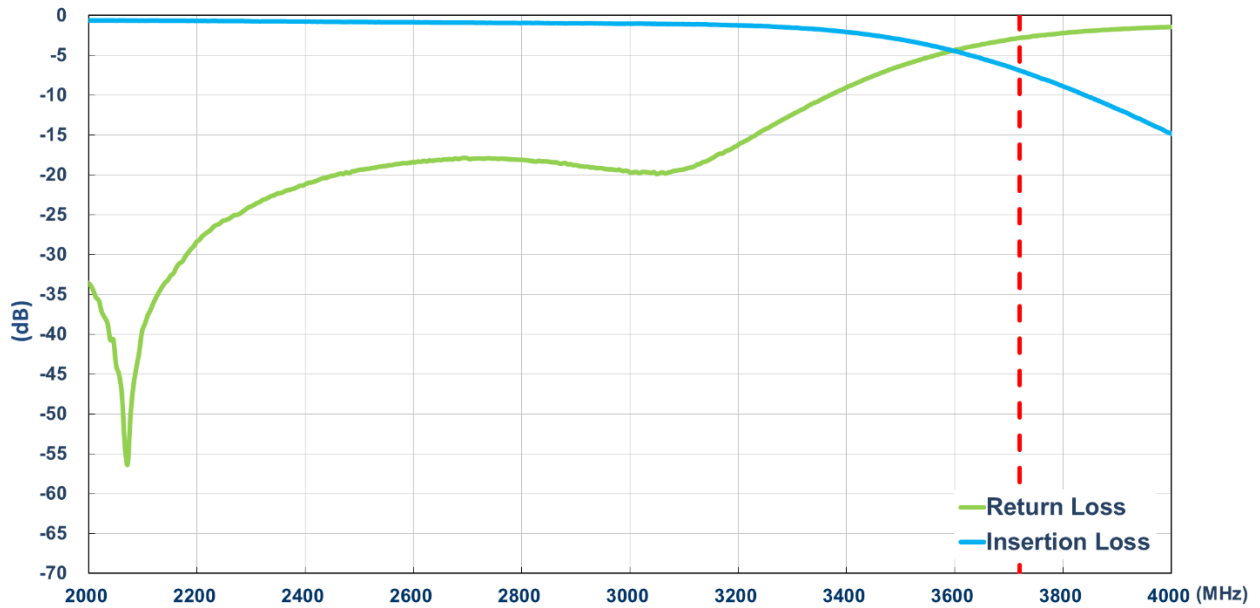

3.2. Out-Of-Band Attenuation

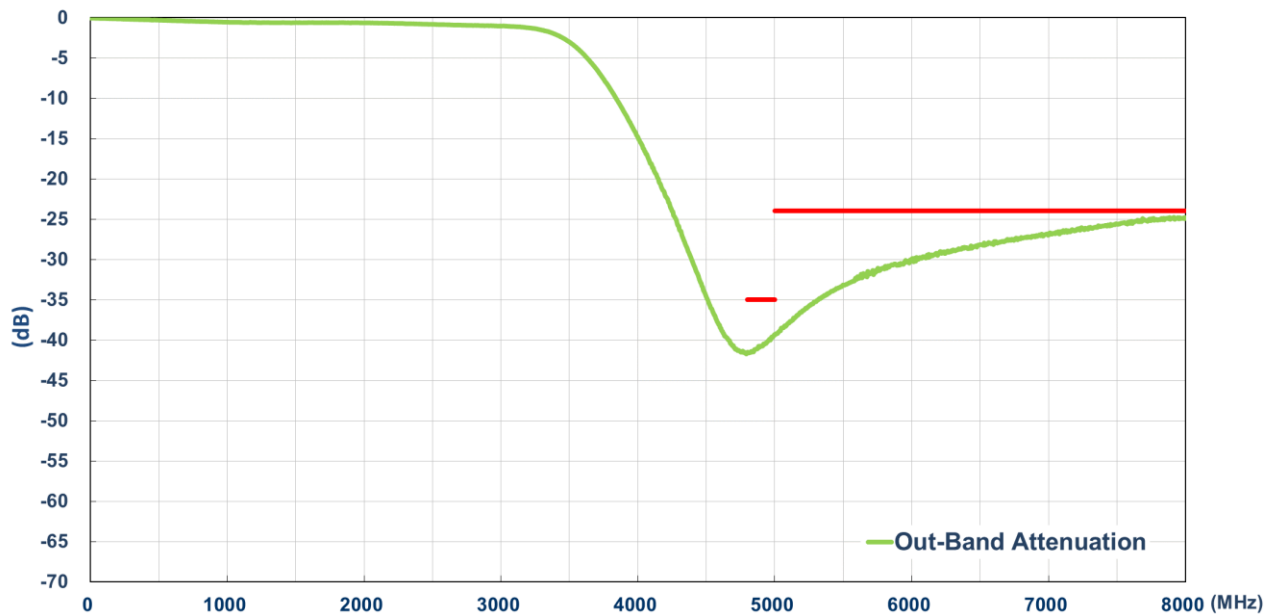

4. Mechanical Drawing (Unit: mm)

4.1. Antenna Drawing

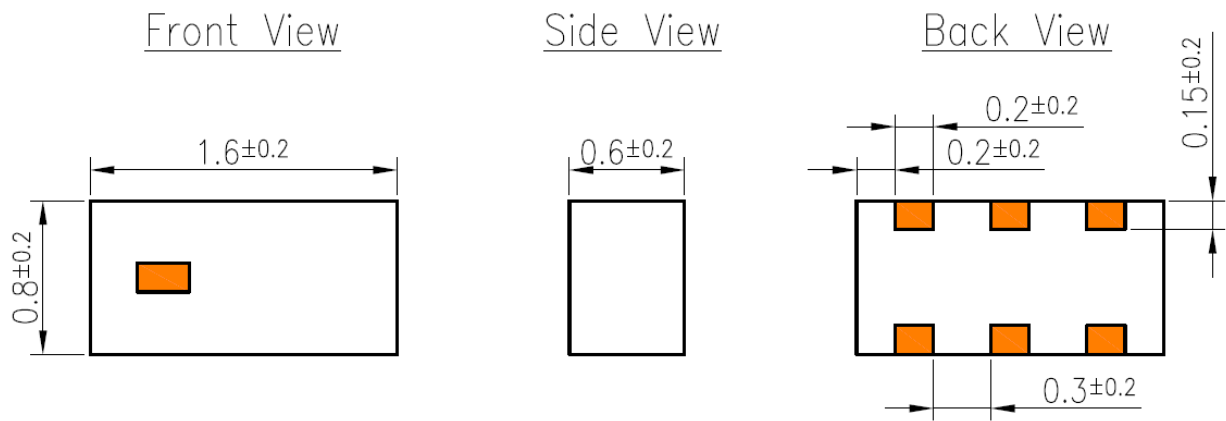

4.2. Recommended PCB Layout



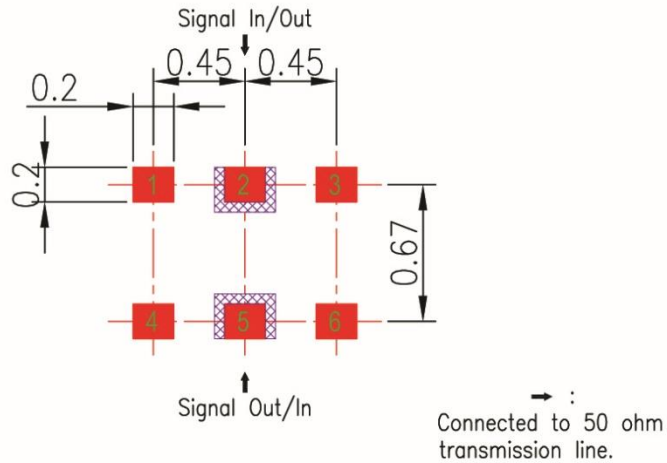

4.2.1. Top Copper

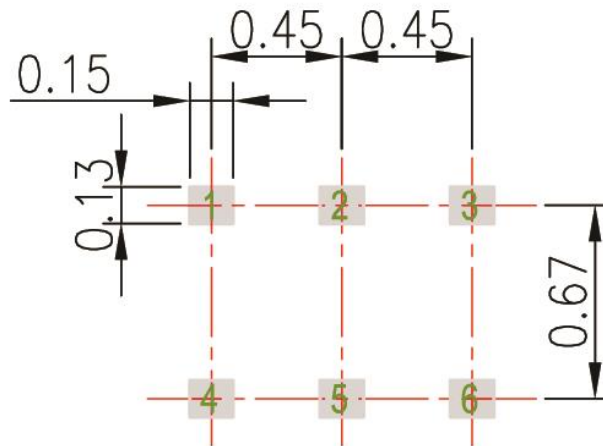

4.2.2. Top Solder Paste



NOTE:

- 1. Ag Plated area 
- 2. Solder Mask area 
- 3. Copper area 
- 4. Paste area 
- 5. Copper Keepout Area 

- 6. Any vias in pads should be either filled or tented to prevent solder from wicking away from the pad during reflow.
- 7. The dimension tolerances should follow standard PCB manufacturing guidelines



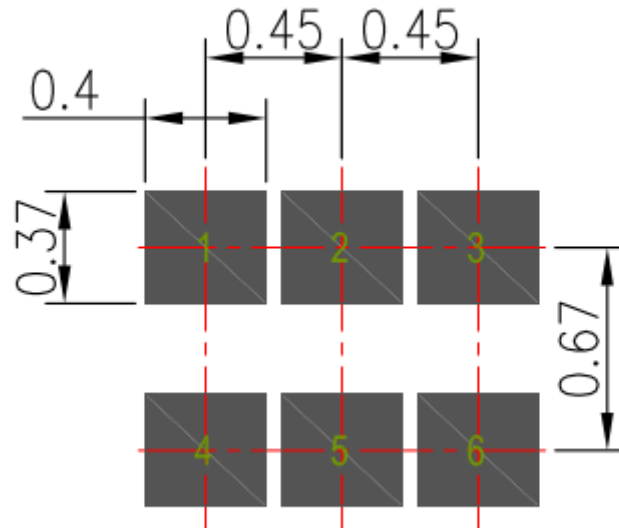

4.2.3. Top Solder Mask

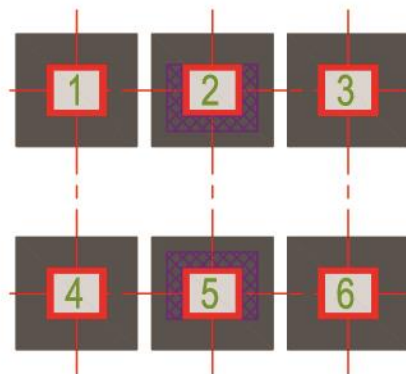

4.2.4. Composite Diagram



NOTE:

- 1. Ag Plated area 
- 2. Solder Mask area 
- 3. Copper area 
- 4. Paste area 
- 5. Copper Keepout Area 

- 6. Any vias in pads should be either filled or tented to prevent solder from wicking away from the pad during reflow.
- 7. The dimension tolerances should follow standard PCB manufacturing guidelines

4.3. Evaluation Board

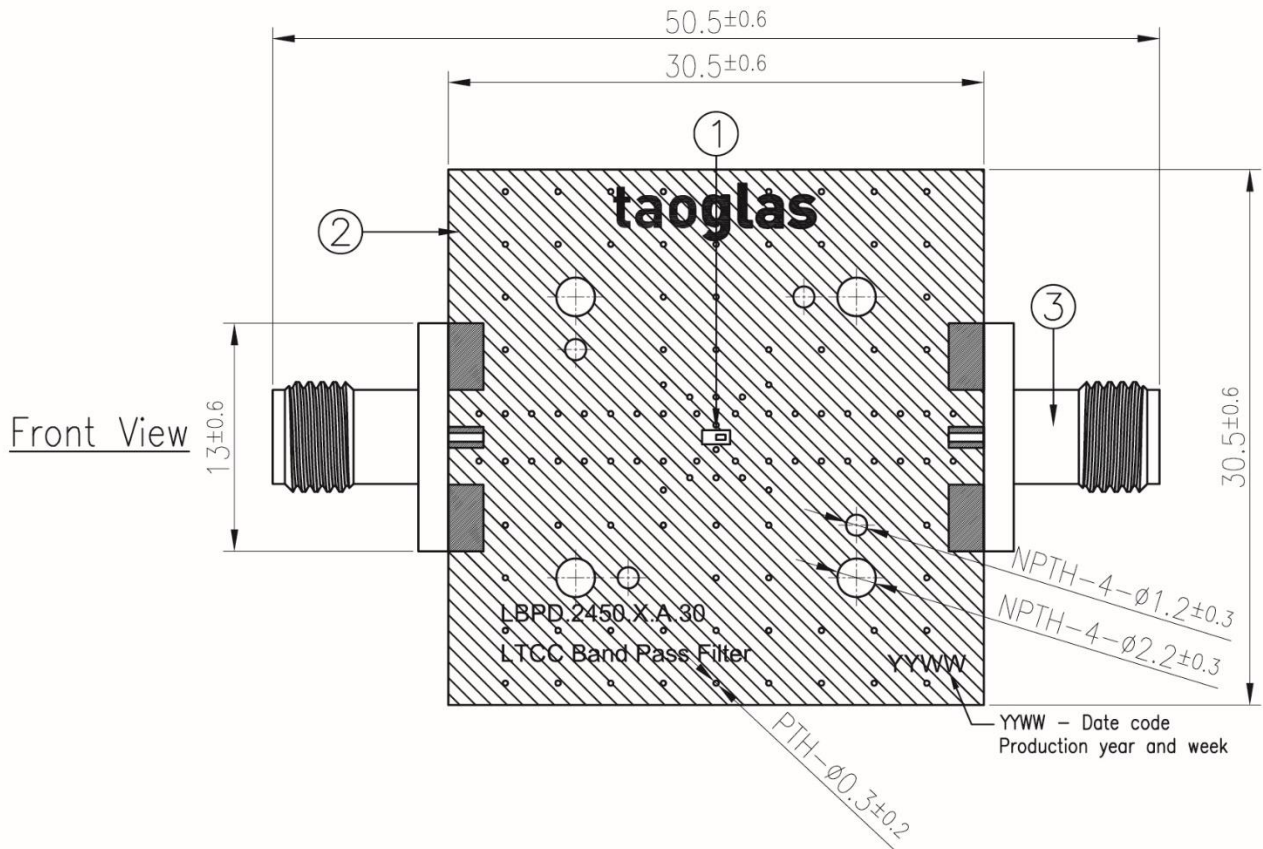

	Name	Material	Finish	QTY
1	Filter (1.6x0.8x0.6mm)	Ceramic	Clear	1
2	PCB	Composite 1.0t	Black	1
3	SMA(F) ST	Brass	Au Plated	2

5. Recommended Reflow Soldering Profile

Phase	Profile Features	Maximum
Preheat	Temperature Min	150 °C
	Temperature Max	180 °C
	Duration	60-120 sec
Ramp-Up	Avg. Ramp up rate	3 °C/sec (max)
Reflow	Temperature	220 °C
	Duration	30-40 sec
Peak	Temperature	265 °C
	Duration	5 sec Max
Ramp Down	Avg. Ramp down rate	3 °C/sec (max)

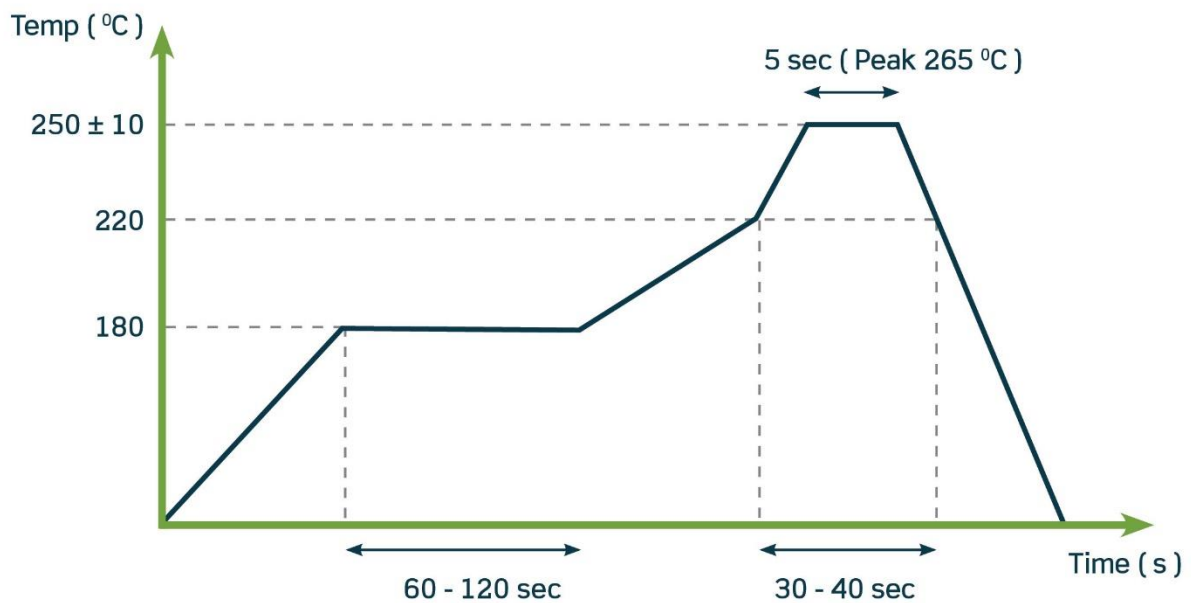

6. Packaging

6000 pc LLP.2450.X.A.30
 1 reel per small inner box
 Dimensions - 178*8.5mm
 Weight - 185g

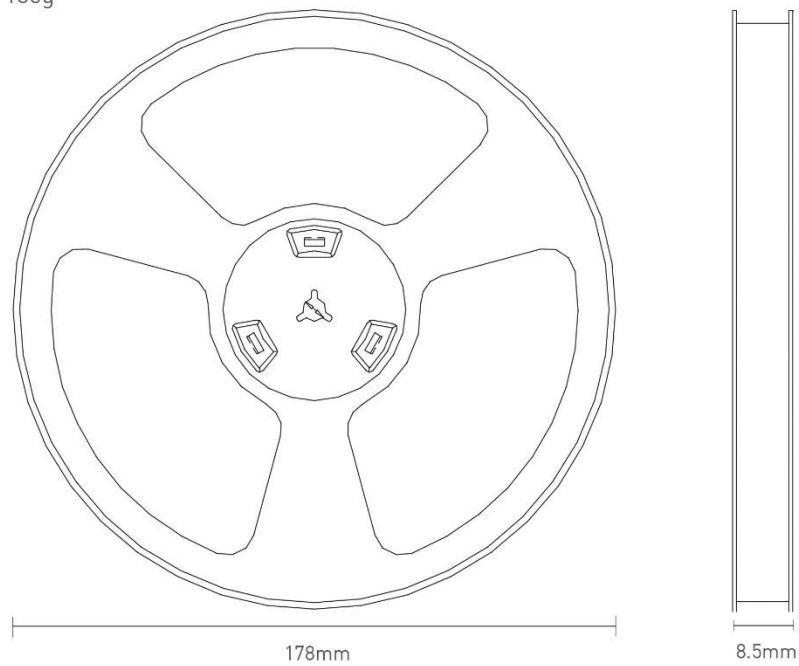

12000 pc LLP.2450.X.A.30
 2 reel in small inner box
 Dimensions - 190*190*28
 Weight - 0.42Kg

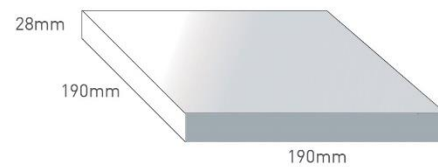

10 inner boxes / 120000 pcs in one carton
 Carton Dimensions - 330*210*210mm
 Weight - 4.5 Kg

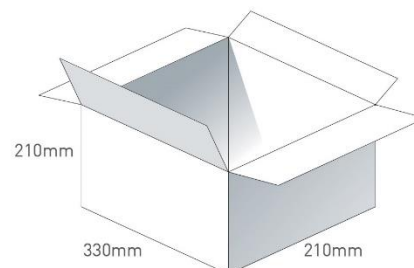

Taoglas makes no warranties based on the accuracy or completeness of the contents of this document and reserves the right to make changes to specifications and product descriptions at any time without notice. Taoglas reserves all rights to this document and the information contained herein.

Reproduction, use or disclosure to third parties without express permission is strictly prohibited.

Copyright © Taoglas Ltd.



Компания «ЭлектроПласт» предлагает заключение долгосрочных отношений при поставках импортных электронных компонентов на взаимовыгодных условиях!

Наши преимущества:

- Оперативные поставки широкого спектра электронных компонентов отечественного и импортного производства напрямую от производителей и с крупнейших мировых складов;
- Поставка более 17-ти миллионов наименований электронных компонентов;
- Поставка сложных, дефицитных, либо снятых с производства позиций;
- Оперативные сроки поставки под заказ (от 5 рабочих дней);
- Экспресс доставка в любую точку России;
- Техническая поддержка проекта, помощь в подборе аналогов, поставка прототипов;
- Система менеджмента качества сертифицирована по Международному стандарту ISO 9001;
- Лицензия ФСБ на осуществление работ с использованием сведений, составляющих государственную тайну;
- Поставка специализированных компонентов (Xilinx, Altera, Analog Devices, Intersil, Interpoint, Microsemi, Aeroflex, Peregrine, Syfer, Eurofarad, Texas Instrument, Miteq, Cobham, E2V, MA-COM, Hittite, Mini-Circuits, General Dynamics и др.);

Помимо этого, одним из направлений компании «ЭлектроПласт» является направление «Источники питания». Мы предлагаем Вам помощь Конструкторского отдела:

- Подбор оптимального решения, техническое обоснование при выборе компонента;
- Подбор аналогов;
- Консультации по применению компонента;
- Поставка образцов и прототипов;
- Техническая поддержка проекта;
- Защита от снятия компонента с производства.



Как с нами связаться

Телефон: 8 (812) 309 58 32 (многоканальный)

Факс: 8 (812) 320-02-42

Электронная почта: org@eplast1.ru

Адрес: 198099, г. Санкт-Петербург, ул. Калинина, дом 2, корпус 4, литера А.