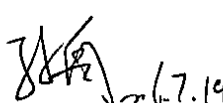
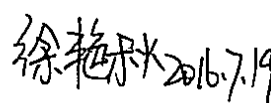
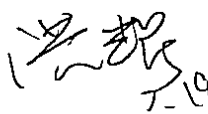
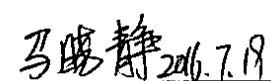

Product Specification

Product Name: T121NB01D01

Customer
Approved by Customer
Approved Date:

Designed By	Checked by	Approved By	
		R&D	QA
 2016.7.19	 2016.7.19	 7-19	 2016.7.19

CONTENT

REVISION RECORD	3
1 OVERVIEW	4
2 FEATURES	4
3 GENERAL INFORMATION	4
4 MECHANICAL DRAWING	5
5 MODULE INTERFACE	6
5.1 PIN DESCRIPTION	6
5.2 BACK-LIGHT UNIT	7
6 ABSOLUTE MAXIMUM RATING	8
7 ELECTRICAL CHARACTERISTICS	8
7.1 DC ELECTRICAL CHARACTERISTICS	8
7.2 AC ELECTRICAL CHARACTERISTICS	9
8 FUNCTIONAL SPECIFICATION AND APPLICATION CIRCUIT	12
8.1 POWER ON/OFF SEQUENCE	12
9 OPTICAL CHARACTERISTICS	13
10 PACKAGE SPECIFICATION	14
11 RELIABILITY	17
12 ILLUSTRATION OF PRODUCT NAME	18
13 PRECAUTIONS FOR OPERATION AND STORAGE	19
13.1 PRECAUTIONS FOR OPERATION	19
13.2 SOLDERING	19
13.3 PRECAUTIONS FOR STORAGE.....	19
13.4 WARRANTY PERIOD	19

1 Overview

The specifications is a transmissive type color active matrix liquid crystal display (LCD) which uses amorphous thin film transistor (TFT) as switching devices. This product is composed of a TFT LCD panel, driver IC, FPC, and a backlight unit.

2 Features

- Panel Size: 12.1 inch
- Number of Pixels /Resolution: 1024×RGB×768
- Interface: LVDS
- RoHS and Halogen-Free Compliance
- Applications: Multimedia application and other hand application

3 General Information

NO.	ITEM	SPECIFICATION	UNIT
1	Dot Matrix	1024(W)×768(H)	Pixels
2	Dot Pitch	0.24(W)×0.24(H)	mm
3	Active Area	245.76(W)×184.32(H)	mm
4	Module Size	279.0(W)×209.0(H)×9.0(T)	mm
5	Viewing Angle	6 O'clock	mm
6	Module Weight	545(MAX)	gram

4 Mechanical Drawing

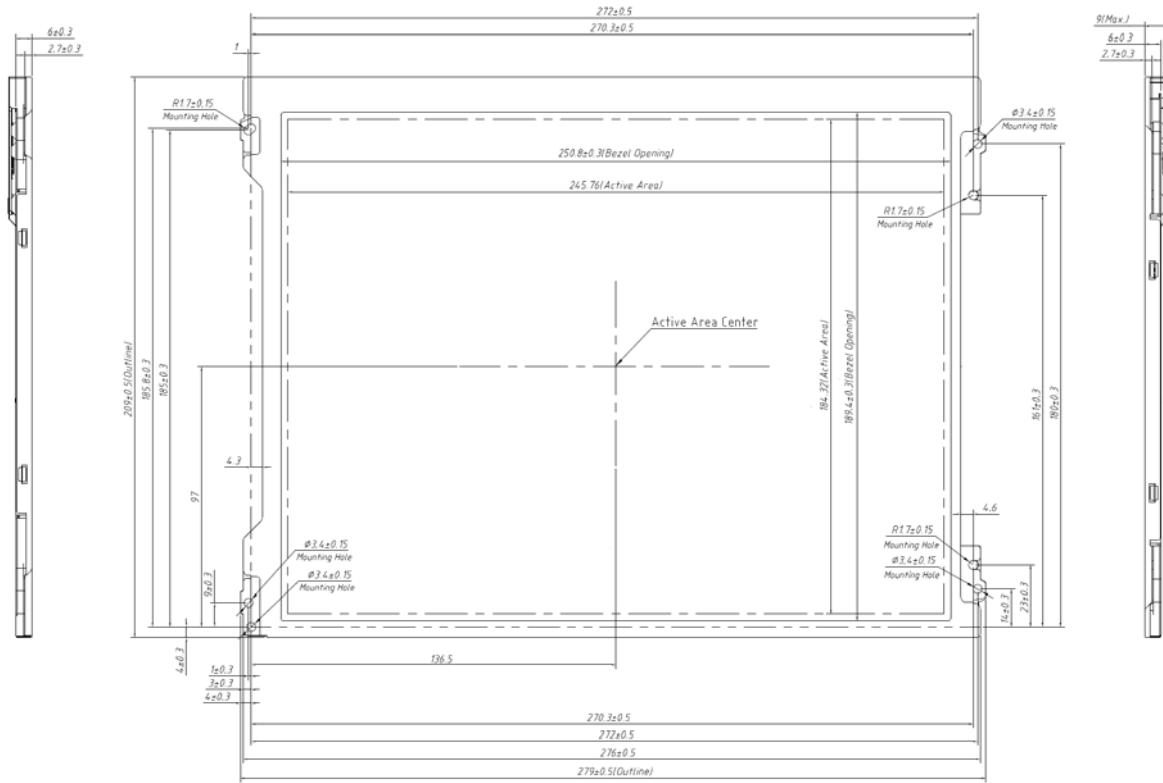

Front Side

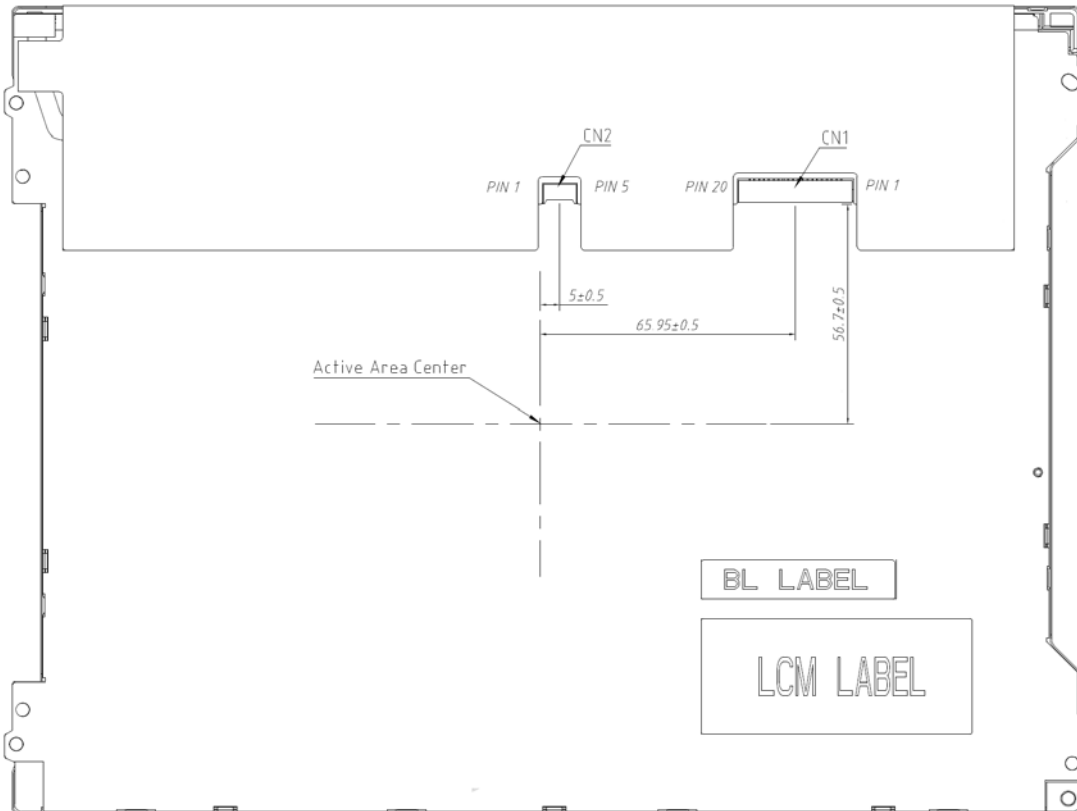

Back Side

5 Module Interface

5.1 PIN Description

NO.	Symbol	Description
1	VDD	Power Supply, 3.3V (typical)
2	VDD	Power Supply, 3.3V (typical)
3	VSS	GND
4	REV	Reverse Scan selection {High:2.5(min), 3.3(typ),3.6(max); Low: 0.5(max)}
5	Rin1-	-LVDS differential data input (R0-R5,G0)
6	Rin1+	+LVDS differential data input (R0-R5,G0)
7	VSS	Ground
8	Rin2-	LVDS differential data input (G1-G5,B0-B1)
9	Rin2+	+LVDS differential data input (G1-G5,B0-B1)
10	VSS	Ground
11	Rin3-	-LVDS differential data input (B2-B5,HS,VS,DE)
12	Rin3+	+LVDS differential data input (B2-B5,HS,VS,DE)
13	VSS	Ground
14	ClkIN-	-LVDS differential clock input
15	ClkIN+	+LVDS differential clock input
16	GND	Ground
17	Rin4-	-LVDS differential data input (R6-R7,G6-G7,B6-B7)
18	Rin4+	+VDS differential data input (R6-R7,G6-G7,B6-B7)
19	SEL68	6/8 bits LVDS data input selection(H:8bit L/NC:6bit)
20	Bist	Internal use

Note(1) : All input signals shall be low or Hi-resistance state when VDD is off.

Note (2) REV = LOW/NC

Note (3) REV = High



5.2 Back-Light Unit

Item	Symbol	Min.	Typ.	Max.	Unit
Supply Voltage	Vf	2.8	3.3	3.6	V
Supply Current	If	-	60	-	mA
Uniformity	-	75	80	-	%
Life Time	-	30,000	-	-	Hr

5.2.1 LED Backlight Block Diagram

TBD

5.2.2 Definition of Luminance Uniformity

Measure the luminance of gray level 255 at 9 points.

$$UNF(9pts) = \frac{\text{Min}(L1, L2, \dots L9)}{\text{Max}(L1, L2, \dots L9)}$$

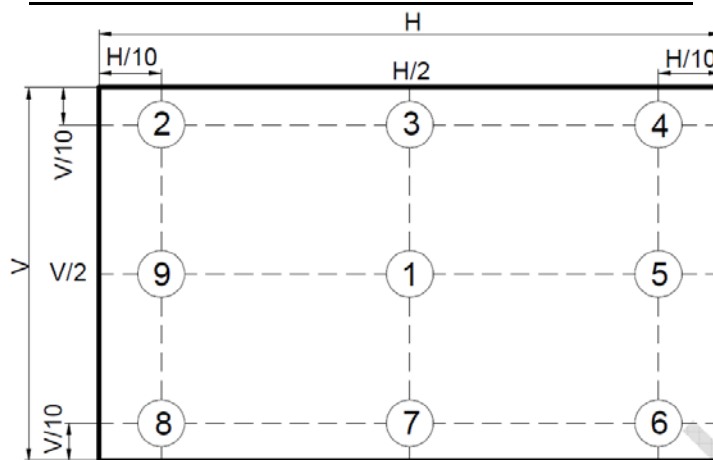

6 Absolute Maximum Rating

Electrical Absolute Rating

Item	Symbol	Min.	Max.	Unit
Supply voltage for logic	VDD	-0.5	5	V
Operating temperature	TOP	-20	70	°C
Operating Humidity	HOP	10	85	%RH
Storage temperature	TST	-30	80	°C
Storage Humidity	HST	10	95	%RH

7 Electrical Characteristics

7.1 DC Electrical Characteristics

Item	Symbol	Min.	Typ.	Max.	Unit	
Supply voltage(Logic)	VDD	3.0	3.3	3.6	V	
Input Voltage	H level	V_{IH}	$0.7 \times VCC$	-	VCC	V
	L level	V_{IL}	-0.3	-	$0.3 \times VCC$	V
Supply current	I_{DD}	-	-	250	mA	
VDD Power Consumption	PDD	-	-	0.825	W	

Note: Voltage greater than above may damage the module.

All voltages are specified relative to VSS=0V.

7.2 AC Electrical Characteristics

7.2.1 LVDS Receiver

Signal Electrical Characteristics For LVDS Receiver

The built-in LVDS receiver is compatible with (ANSI/TIA/TIA-644) standard.

Parameter	Symbol	Min.	Typ.	Max.	Unit	Conditions
Differential Input High Threshold	Vth	-	-	+100	mV	$V_{CM}=+1.2V$
Differential Input Low Threshold	Vtl	-100	-	-	mV	$V_{CM}=+1.2V$
Magnitude Differential Input Voltage	VID	100	-	600	mV	-
Common Mode Voltage	V_{CM}	$ VID /2+0.6$	1.2	$1.8- VID /2$	V	-
Common Mode Voltage Offset	ΔV_{CM}	-	-	50	mV	$V_{CM}=+1.2V$

- Note:
- (1) Input signals shall be low or Hi- resistance state when VDD is off.
 - (2) All electrical characteristics for LVDS signal are defined and shall be measured at the interface connector of LCD.

Voltage Definitions

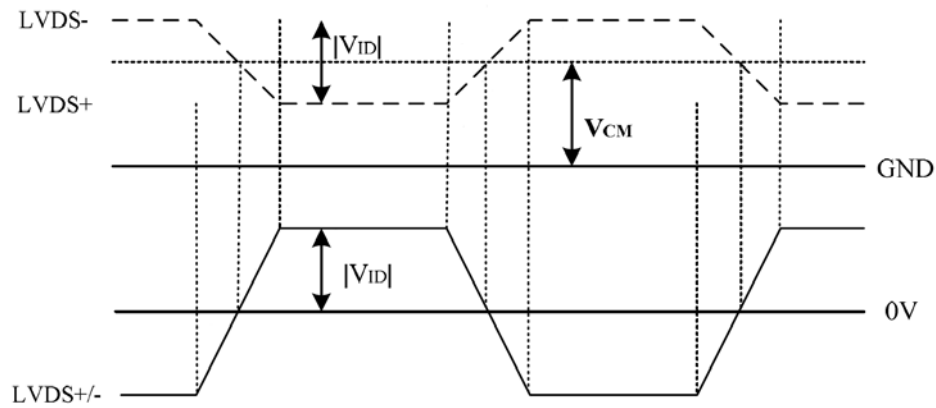

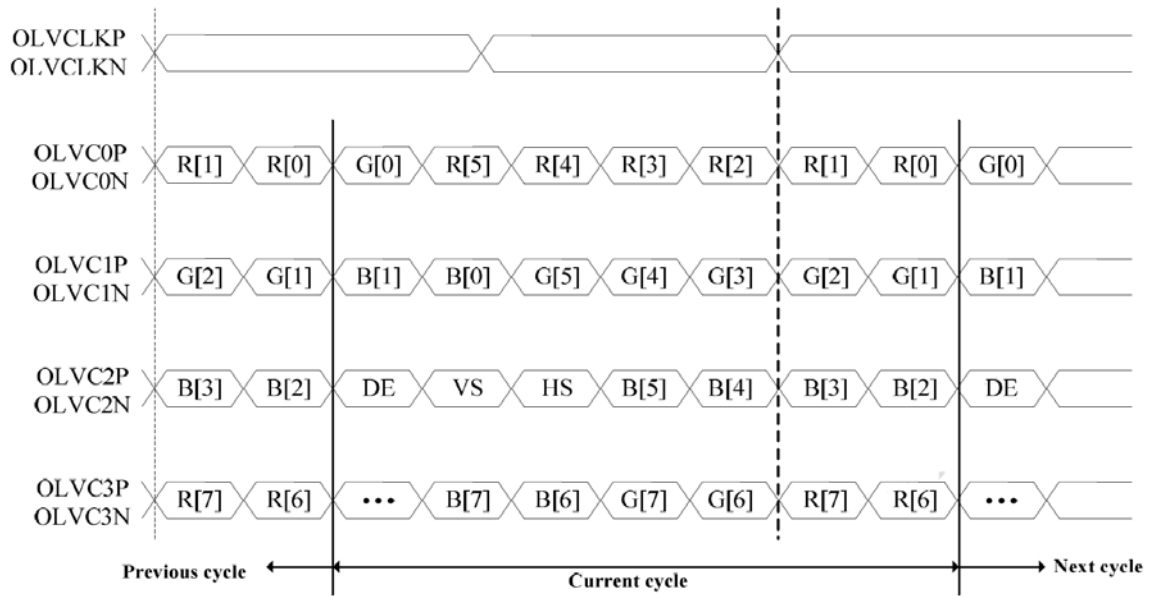

Data Mapping(8 Bit)

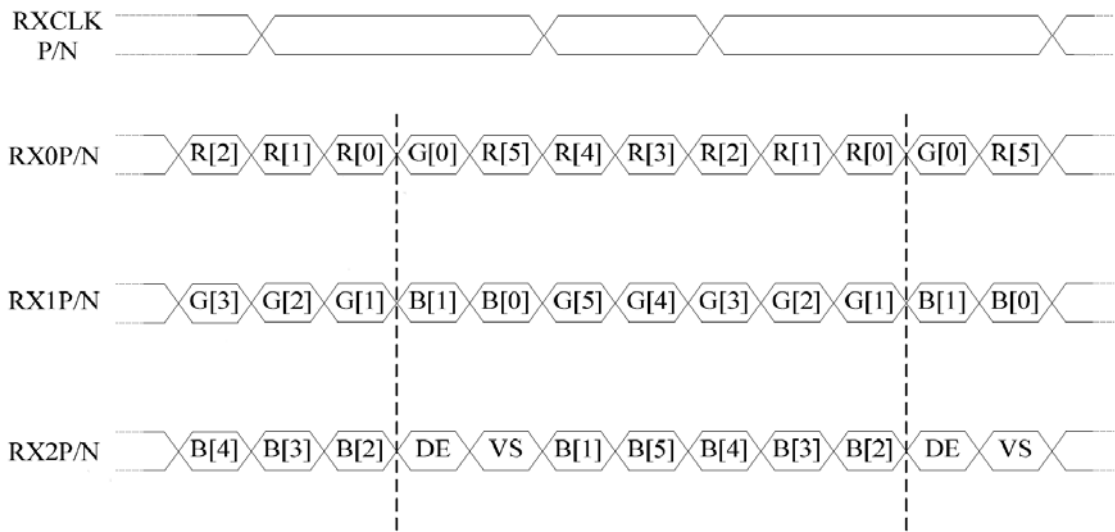

Data Mapping(6 Bit)

7.2.2 Interface Timings

Parameter	Symbol	Unit	Min.	Typ.	Max.
LVDS Clock Frequency	Fclk	MHz	50	65	80
H Total Time	HT	Clocks	1100	1344	2047
H Active Time	HA	Clocks	1024	1024	1024
H Blanking Time	HBL	Clocks	76	320	1023
V Total Time	VT	Lines	776	806	1023
V Active Time	VA	Lines	768	768	768
V Blanking Time	VBL	Lines	8	38	255
Frame Rate	Vsync	Hz	55	60	65

Note: H Blanking Time and V Blanking Time can not be changed at every frame.

Timing Characteristics

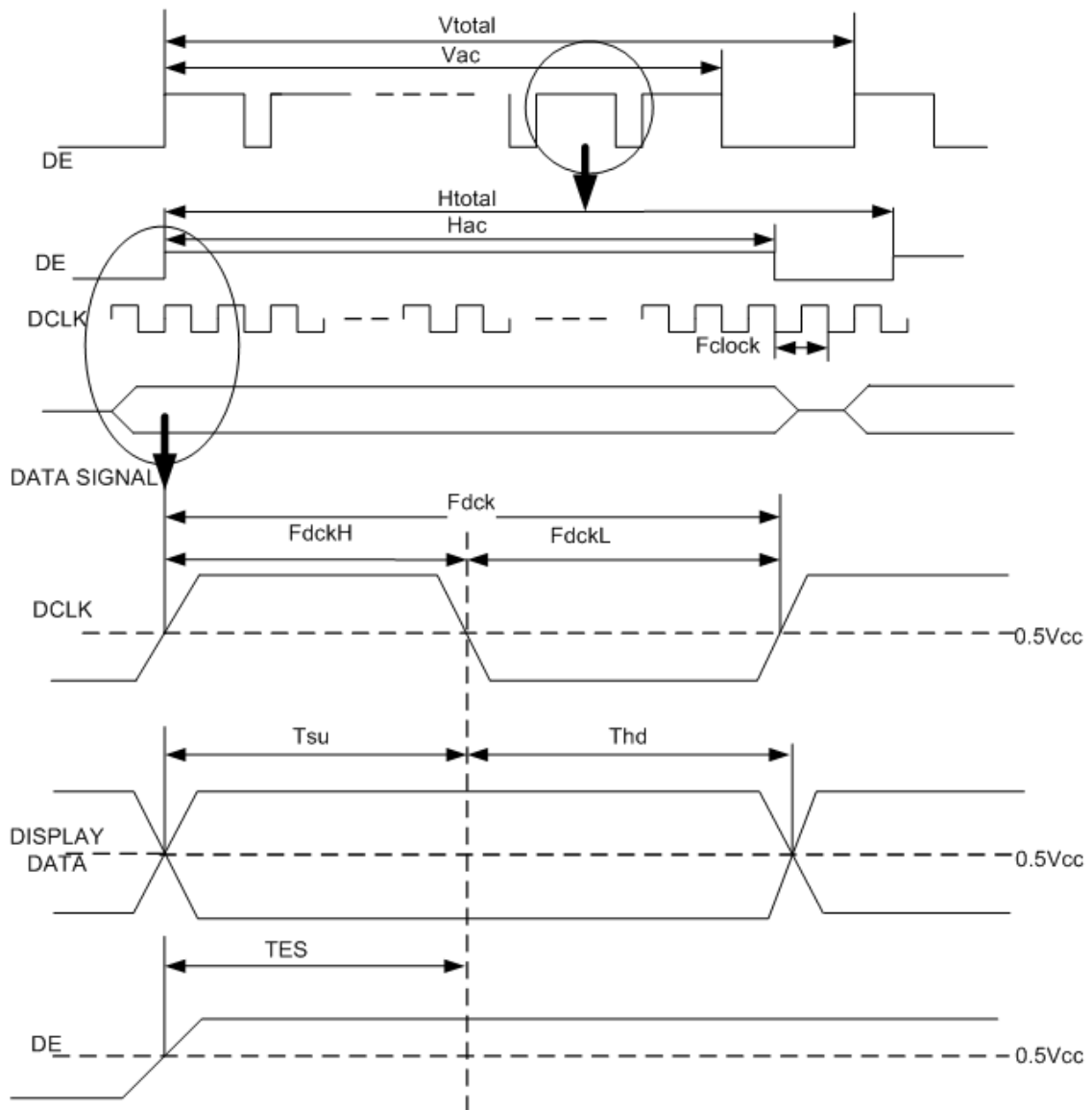

8 Functional Specification and Application Circuit

8.1 Power ON/OFF Sequence

Power on/off sequence is as follows. Interface signals are also shown in the chart. Signals from any system shall be Hi-resistance state or low level when VDD is off.

Power Voltage

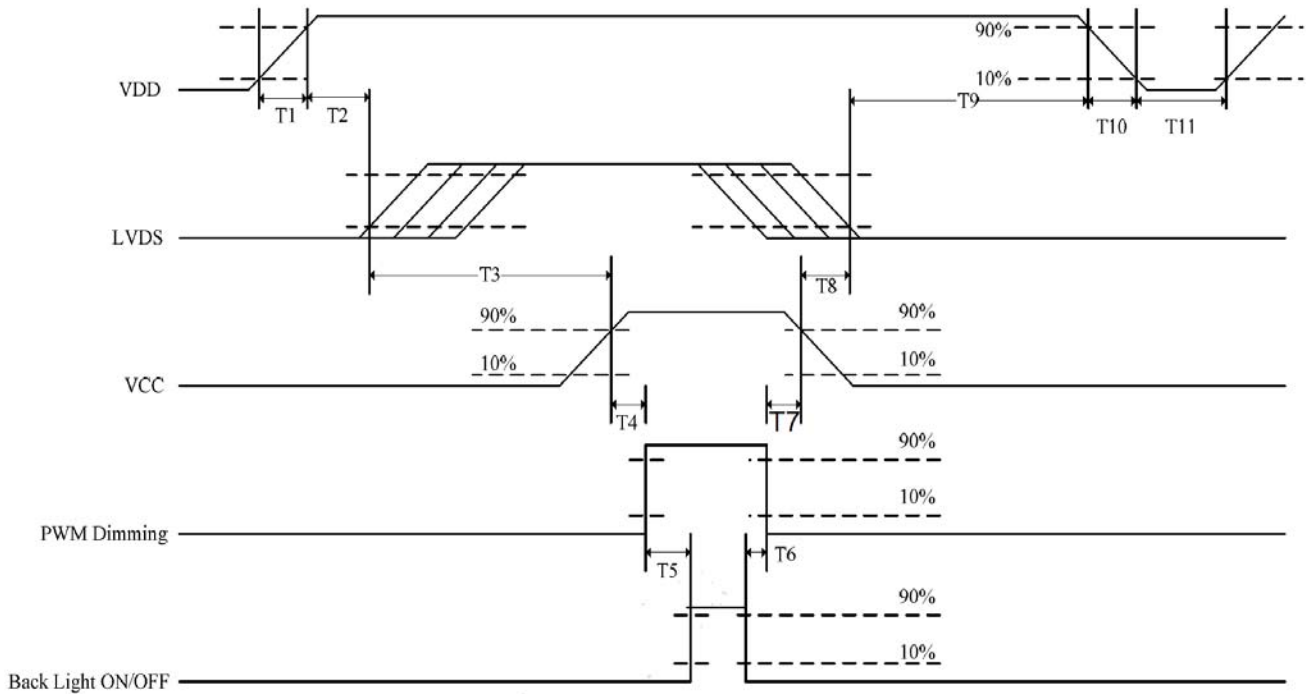

Power Sequencing Requirements

Parameter	Unit	min	typ	max
T1	ms	0.5	-	10
T2	ms	30	40	50
T3	ms	200	-	-
T4	ms	10	-	-
T5	ms	10	-	-
T6	ms	0	-	-
T7	ms	10	-	-
T8	ms	100	-	-
T9	ms	0	16	50
T10	ms	-	-	10
T11	ms	1000	-	-

Note (1) Power On Sequence: VCC-> AVDD -> VGL -> VGH -> Data -> B/L

(2) Power Off Sequence: B/L-> Data -> VGH -> VGL -> AVDD -> VCC

9 Optical characteristics

Item	Symbol	Condition	Min.	Typ.	Max.	Units	Note	
Viewing Angle	Horizontal	θ_{x+}	70	80	-	degree	(1),(2),(3)	
		θ_{x-}	70	80	-			
	Vertical	θ_{y+}	70	80	-			
		θ_{y-}	60	80	-			
Contrast Ratio	Center		720	800	-	-	(1),(2),(4)	
Response Time	Rising (90%-10%)		-	4	5.2	ms	(1),(2),(5)	
	Falling(90%-10%)		-	12	15.6			
	Rising + Falling		-	16	20.8			
Chromaticity (CIE1931)	White	x	0.255	0.305	0.355	-	(1),(2)	
		y	0.275	0.325	0.375			
	Red	x	Typ. -0.03	0.644	Typ. +0.03			
		y		0.344				
	Green	x		0.310				
		y		0.634				
	Blue	x		0.152				
		y		0.081				
NTSC				-		72	-	-
White Luminance	5 Points Average			315		350	-	cd/m ²

Note (1) Measurement Setup:

The LCD module should be stabilized at given temperature(25) for 15 minutes to Avoid abrupt temperature change during measuring. In order to stabilize the luminance, the measurement should be executed after lighting backlight for 15 minutes in a windless room.

Measurement Setup

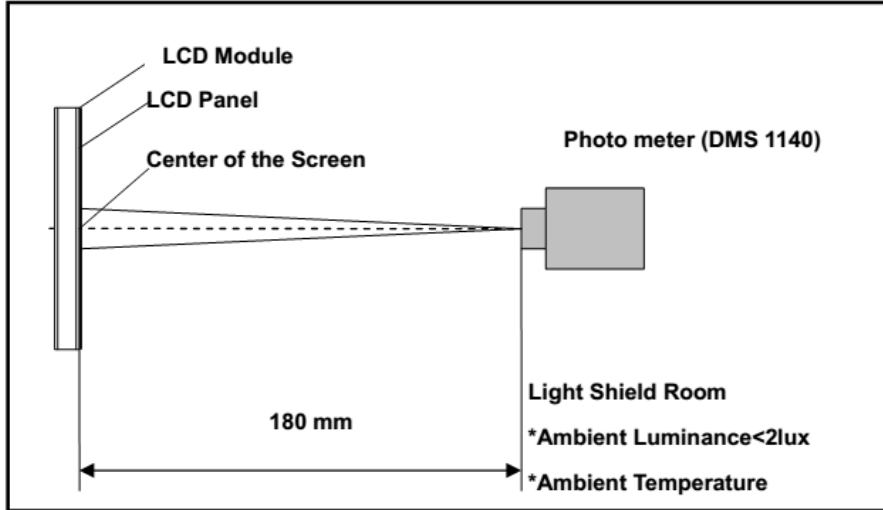

Note (2) The LED input parameter setting as:

VLED: 12V;

PWM_LED: Duty 100 %

Note (3) Definition of Viewing Angle

Definition of Viewing Angle

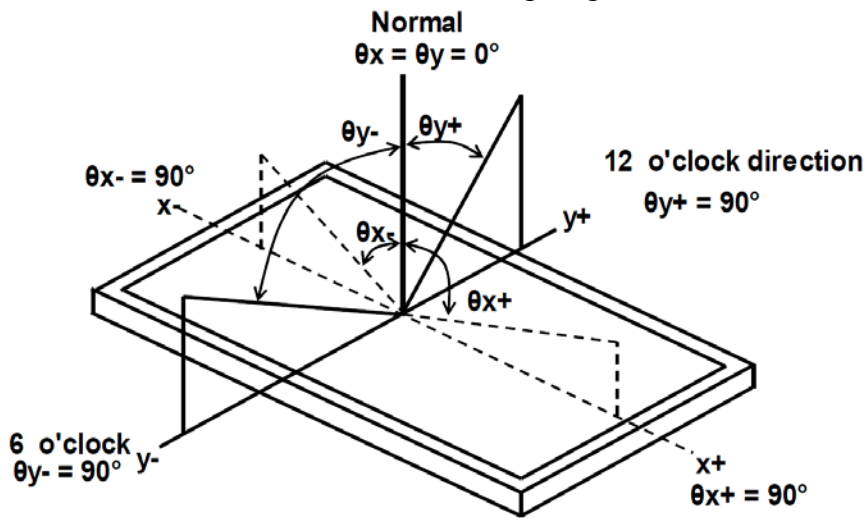

Note (4) Definition Of Contrast Ratio (CR)

The contrast ratio can be calculated by the following expression

$$\text{Contrast Ratio (CR)} = L_{255} / L_0$$

L_{255} : Luminance of gray level 255, L_0 : Luminance of gray level 0

Note (5) Definition Of Response Time (TR, TF)

Definition of Response Time

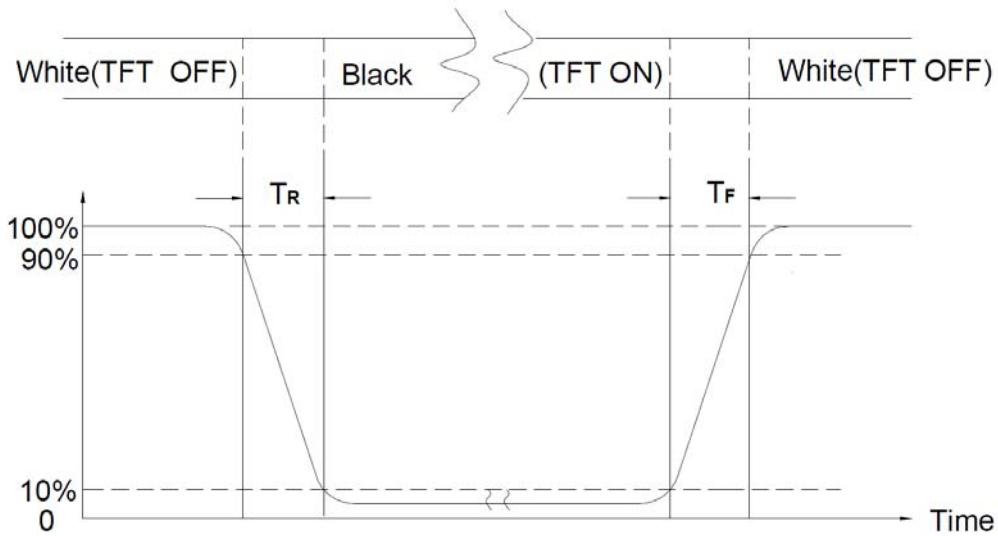

Note (6) Definition Of Luminance White

Measure the luminance of gray level L255 at center point (Ref.: Active Area) Display Luminance=
 $(L1+L2+L3+L4+L5) / 5$

H—Active area length, V—Active area width, L—Luminance

Measurement Locations

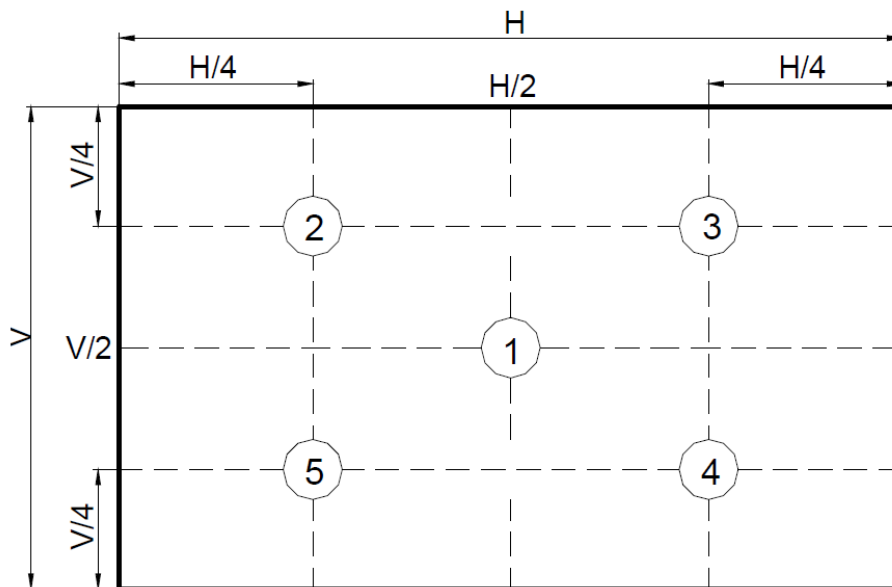

10 Package Specification

TBD

11 Reliability

Item.	Condition	Time (hrs)	Assessment
High temp. Storage	85°C	240	No abnormalities in function sand appearance
High temp. Operating	85°C	240	
Low temp. Storage	-40°C	240	
Low temp. Operating	-30°C	240	
Humidity	60°C/ 90%RH	240	
Thermal Shock Temp.Cycle	-40°C(30min.) ~85°C (30min.),200 cycles	-	

12 Illustration of Product Name

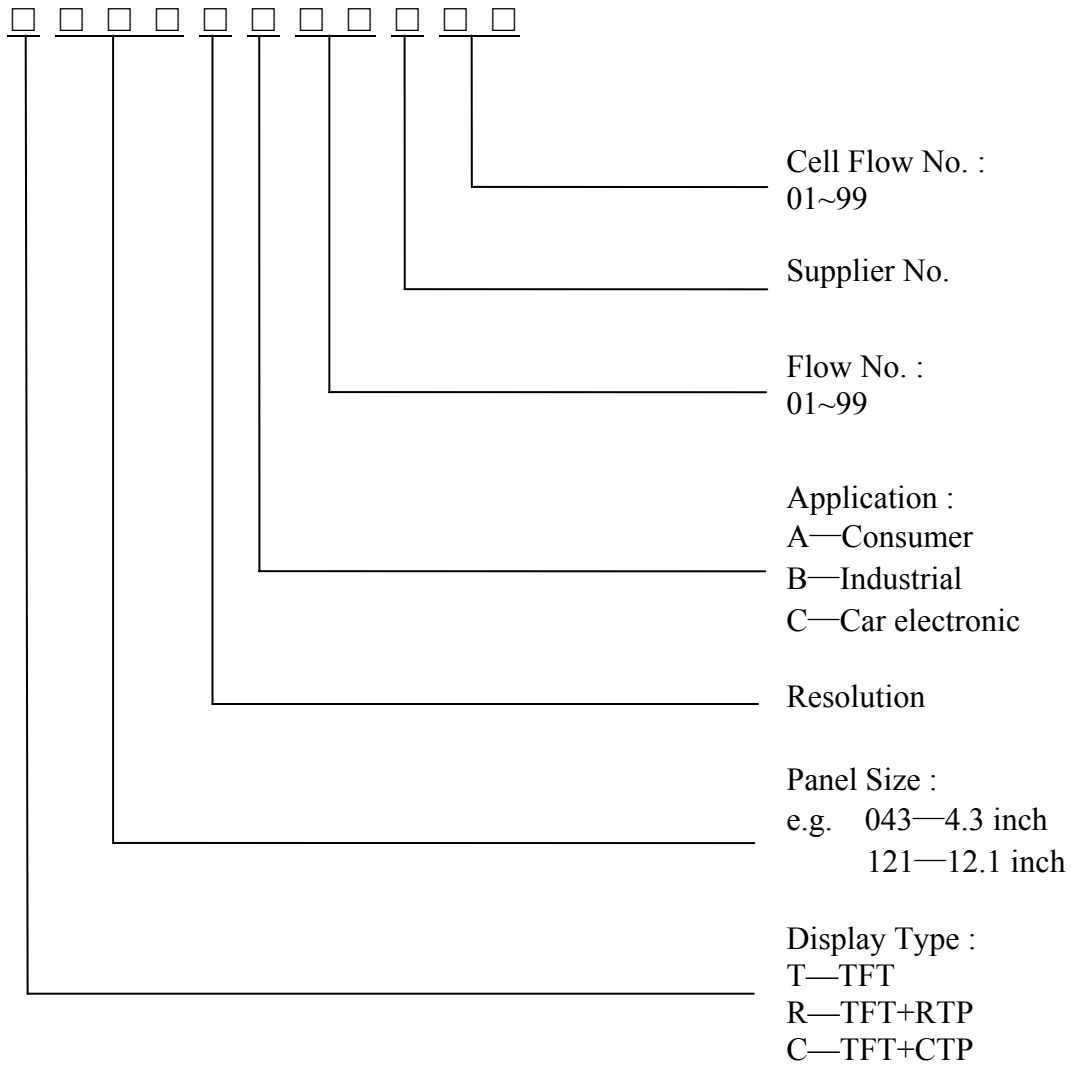

13 Precautions for operation and Storage

13.1 Precautions for Operation

- (1) Since the display panel is made of glass, do not apply any mechanical shock or impact or excessive force to it when installing the module. Any strong mechanical impact due to falling dropping etc. may cause damage (breakage or cracking).
- (2) If the display panel is damaged and the liquid crystal substance inside it leaks out, be sure not to get any in your mouth, if the substance comes into contact with your skin or clothes, promptly wash it off using soap and water.
- (3) The polarizer on the display surface is made of soft material and is easily scratched. Please take most care when handing. When the display surface is contaminated, please wipe it off gently by using moisten soft cloth with isopropyl alcohol, do not use water, ketone or aromatics. If still not completely clear, moisten cloth with isopropyl alcohol or ethyl alcohol solvents.
- (4) When handling the LCD module, please be sure that the body and the tools are properly grounded. And do not touch I/O pins with bare hands or contaminate I/O pins, it will cause disconnection or defective insulation of terminals.
- (5) Do not attempt to disassemble or process the LCD module.
- (6) The LCD Module is coated with a film to protect the display surface. Be care when peeling off this protective film since static electricity may be generated. To reduce the amount of static electricity generated, do not conduct assembly and other work under dry conditions.
- (7) Do not put one product on the other .Otherwise, it may cause the product to bescratched and/or change on cosmetic occur (ex. Newton ring).

13.2 Soldering

- (1) Soldering should be performed only on the I/O terminals.
- (2) Use soldering irons with proper grounding and no leakage.
- (3) Iron: no higher than 300°C and 3~4 sec during soldering.

13.3 Precautions for Storage

- (1) Please store LCD module in a dark place. Avoid exposure to sunlight, the light of fluorescent lamp or any ultraviolet ray.
- (2) Keep the environment temperature between 0°C and 40°C and the relative humidity less than 80%.Avoid high temperature and high humidity.
- (3) Keep the LCD modules stored in the room without acid ,alkali and harmful gas.

13.4 Warranty period

Visionox warrants for a period of 12 months from the shipping date when stored or used under normal condition.



Компания «ЭлектроПласт» предлагает заключение долгосрочных отношений при поставках импортных электронных компонентов на взаимовыгодных условиях!

Наши преимущества:

- Оперативные поставки широкого спектра электронных компонентов отечественного и импортного производства напрямую от производителей и с крупнейших мировых складов;
- Поставка более 17-ти миллионов наименований электронных компонентов;
- Поставка сложных, дефицитных, либо снятых с производства позиций;
- Оперативные сроки поставки под заказ (от 5 рабочих дней);
- Экспресс доставка в любую точку России;
- Техническая поддержка проекта, помощь в подборе аналогов, поставка прототипов;
- Система менеджмента качества сертифицирована по Международному стандарту ISO 9001;
- Лицензия ФСБ на осуществление работ с использованием сведений, составляющих государственную тайну;
- Поставка специализированных компонентов (Xilinx, Altera, Analog Devices, Intersil, Interpoint, Microsemi, Aeroflex, Peregrine, Syfer, Eurofarad, Texas Instrument, Miteq, Cobham, E2V, MA-COM, Hittite, Mini-Circuits, General Dynamics и др.);

Помимо этого, одним из направлений компании «ЭлектроПласт» является направление «Источники питания». Мы предлагаем Вам помощь Конструкторского отдела:

- Подбор оптимального решения, техническое обоснование при выборе компонента;
- Подбор аналогов;
- Консультации по применению компонента;
- Поставка образцов и прототипов;
- Техническая поддержка проекта;
- Защита от снятия компонента с производства.



Как с нами связаться

Телефон: 8 (812) 309 58 32 (многоканальный)

Факс: 8 (812) 320-02-42

Электронная почта: org@eplast1.ru

Адрес: 198099, г. Санкт-Петербург, ул. Калинина, дом 2, корпус 4, литера А.