

SEE TABLE
ACROSS ALL
SOLDER CHARGES

DATE CODE
LEAD CODE:
1 = TIN
2 = TIN / LEAD

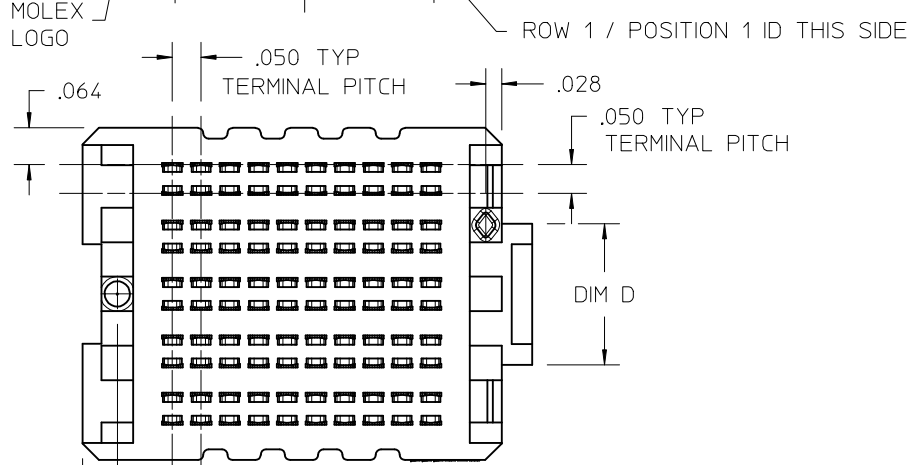

POSITION	
19	.006
10	.006
20	.006
30	.006
40	.006
15	.006
25	.006
35	.009
45	.009

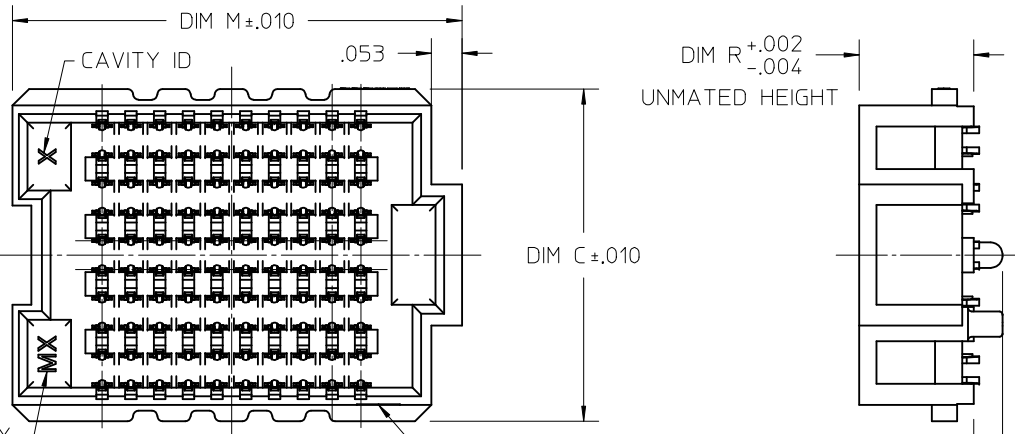
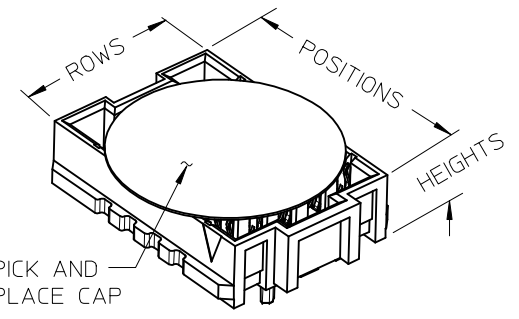

- NOTES:
- MATERIALS: HOUSING: LCP, UL94V-0, BLACK
CONTACTS: COPPER ALLOY
SOLDER CHARGE: SEE CHART
 - FINISH: SELECT GOLD IN CONTACT AREA: 30 MI MIN
SELECT TIN IN TAIL, 50 MI MIN
OVERALL NICKEL
 - PRODUCT SPECIFICATION: PS-45970-001
 - PACKAGING SPECIFICATION: SEE CHART
 - MATES WITH SEARAY PLUG ASSEMBLY 45970
 - APPLICATION SPECIFICATION: AS-45970-001
 - COSMETIC SPECIFICATION: PS-45499-002 CLASS B
 - PART STATUS: CONTACT MOLEX

CORRECTED VIEWS (MINOR) EC NO: UCP2013-0333 DRWN: TGREGOR I 2012/07/25 CHKD: JCOMERC I 2012/07/25 APPR: JCOMERC I 2012/07/25	REV	DESCRIPTION

GENERAL TOLERANCES (UNLESS SPECIFIED)		
	mm	INCH
4 PLACES	± .005	± .0005
3 PLACES	± .005	± .0005
2 PLACES	± .005	± .0005
1 PLACE	± .005	± .0005
ANGULAR ± .005°		
DRAFT WHERE APPLICABLE MUST REMAIN WITHIN DIMENSIONS		

DIMENSION STYLE INCH ONLY	
DRAWN BY TGREGOR I	DATE 2005/05/17
CHECKED BY JCOMERC I	DATE 2005/05/17
APPROVED BY JCOMERC I	DATE 2010/03/05
MATERIAL NO. SEE CHART	
SIZE A	

SCALE 3:1	DESIGN UNITS INCH	THIRD ANGLE PROJECTION
TITLE SEARAY RECEPTACLE ASSEMBLY .050 CENTERS		
MOLEX INCORPORATED		
DOCUMENT NO. SD-45971-001	SHEET NO. 1 OF 10	

6

5

4

3

2

1

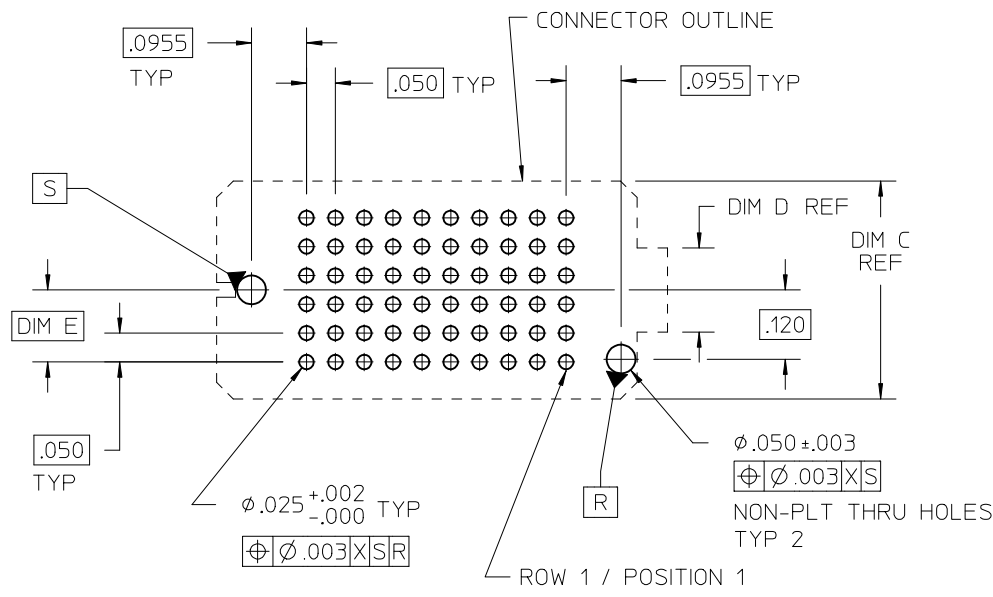

F
 .005
 MIN SOLDER
 PASTE THICKNESS

NO OF ROWS	DIM C	DIM D	DIM E
6	.378	.146	.125
8	.478	.146	.175
10	.578	.246	.225
12	.678	.346	.275

RECOMMENDED PCB LAYOUT: COMPONENT SIDE
 SOLDER SCREEN APERTURE SIZE: .035
 PCB THICKNESS: NA



DIM P PLUG STACK HEIGHT	DIM R RECEPTACLE STACK HEIGHT					
	MM	5.0	6.0	6.5	7.5	8.0
2.0	7.0	8.0	8.5	9.5	10.0	
3.0	8.0	9.0	9.5	10.5	11.0	
3.5	8.5	9.5	10.0	11.0	11.5	
2.5	7.5	8.5	9.0	10.0	10.5	
4.5	9.5	10.5	11.0	12.0	12.5	
5.0	10.0	11.0	11.5	12.5	13.0	
7.0	12.0	13.0	13.5	14.5	15.0	

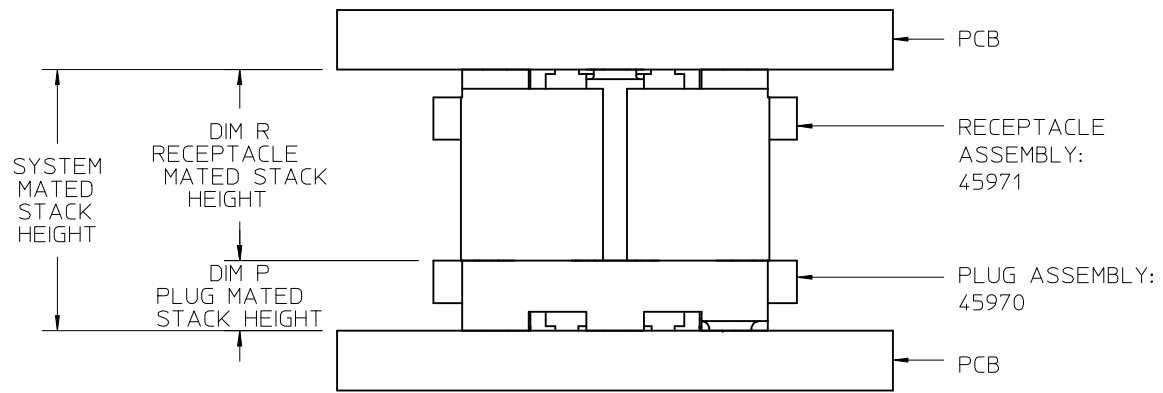

MATED STACK HEIGHTS
 (MILLIMETERS) REF

STACK HEIGHTS GIVEN IN METRIC FOR REF ONLY

SEE SHEET 1 EC NO: UCP2013-0333 DRWN: TGREGORI 2012/07/25 CHKD: APPR: JCOMERCI 2012/07/25 REV DESCRIPTION	GENERAL TOLERANCES (UNLESS SPECIFIED)		DIMENSION STYLE INCH ONLY		SCALE 3:1	DESIGN UNITS INCH	THIRD ANGLE PROJECTION	
		mm	INCH	DRAWN BY TGREGORI	DATE 2005/05/17	TITLE SEARAY RECEPTACLE ASSEMBLY .050 CENTERS MOLEX INCORPORATED DOCUMENT NO. SD-45971-001 SHEET NO. 2 OF 10		
	4 PLACES	± ---	± ---	CHECKED BY JCOMERCI	DATE 2005/05/17			
	3 PLACES	± ---	± .005	APPROVED BY JCOMERCI	DATE 2010/03/05			
	2 PLACES	± ---	± ---	MATERIAL NO.	SEE CHARTS			
1 PLACE	± ---	± ---	ANGULAR ± ---°					
DRAFT WHERE APPLICABLE MUST REMAIN WITHIN DIMENSIONS			SIZE A		THIS DRAWING CONTAINS INFORMATION THAT IS PROPRIETARY TO MOLEX INCORPORATED AND SHOULD NOT BE USED WITHOUT WRITTEN PERMISSION			

5

4

3

2

1

DIM R: (REF)		5.0 MM	6.0 MM	6.5 MM	7.5 MM	8.0 MM
DIM R: HOUSING HEIGHT		.199	.238	.258	.297	.317
POSITION	DIM M	MATERIAL NO	MATERIAL NO	MATERIAL NO	MATERIAL NO	MATERIAL NO
19	1.232	45971-0161	OBSOLETE	45971-0361	OBSOLETE	OBSOLETE
10	0.782	OBSOLETE	OBSOLETE	OBSOLETE	OBSOLETE	OBSOLETE
20	1.282	OBSOLETE	OBSOLETE	OBSOLETE	OBSOLETE	OBSOLETE
30	1.782	OBSOLETE	OBSOLETE	OBSOLETE	OBSOLETE	OBSOLETE
40	2.282	OBSOLETE	OBSOLETE	OBSOLETE	OBSOLETE	OBSOLETE
50	2.782	OBSOLETE	OBSOLETE	OBSOLETE	OBSOLETE	OBSOLETE
15	1.032	OBSOLETE	OBSOLETE	OBSOLETE	OBSOLETE	OBSOLETE
25	1.532	OBSOLETE	OBSOLETE	OBSOLETE	OBSOLETE	OBSOLETE
35	2.032	OBSOLETE	OBSOLETE	OBSOLETE	OBSOLETE	OBSOLETE
45	2.532	OBSOLETE	OBSOLETE	OBSOLETE	OBSOLETE	OBSOLETE

STACK HEIGHTS GIVEN IN METRIC FOR REF ONLY

DIM R: (REF)		5.0 MM	6.0 MM	6.5 MM	7.5 MM	8.0 MM
DIM R: HOUSING HEIGHT		.199	.238	.258	.297	.317
POSITION	DIM M	MATERIAL NO	MATERIAL NO	MATERIAL NO	MATERIAL NO	MATERIAL NO
19	1.232	45971-0165	45971-0265	45971-0365	45971-0465	45971-0565
10	0.782	45971-1165	45971-1265	45971-1365	45971-1465	45971-1565
20	1.282	45971-2165	45971-2265	45971-2365	45971-2465	45971-2565
30	1.782	45971-3165	45971-3265	45971-3365	45971-3465	45971-3565
40	2.282	45971-4165	45971-4265	45971-4365	45971-4465	45971-4565
50	2.782	45971-5165	45971-5265	45971-5365	45971-5465	45971-5565
15	1.032	45971-6165	45971-6265	45971-6365	45971-6465	45971-6565
25	1.532	45971-7165	45971-7265	45971-7365	45971-7465	45971-7565
35	2.032	45971-8165	45971-8265	45971-8365	45971-8465	45971-8565
45	2.532	45971-9165	45971-9265	45971-9365	45971-9465	45971-9565

STACK HEIGHTS GIVEN IN METRIC FOR REF ONLY

NOTES:
 1. THIS SHEET CONTAINS THE FOLLOWING OPTIONS
 NO OF ROWS: 6
 SOLDER CHARGE: TIN, 95.5/ Ag 3.8/ Cu 0.7
 PACKAGING: TRAYS AND TAPE AND REEL

SEE SHEET 1
 EC NO: UCP2013-0333
 DRWN: T GREGORI 2012/07/25
 CHKD: JCOMERCI
 APPR: JCOMERCI 2012/07/25

DESCRIPTION

GENERAL TOLERANCES (UNLESS SPECIFIED)

	mm	INCH
4 PLACES	± .005	± .0005
3 PLACES	± .005	± .0005
2 PLACES	± .005	± .0005
1 PLACE	± .005	± .0005
ANGULAR ± .005°		

DRAFT WHERE APPLICABLE
 MUST REMAIN
 WITHIN DIMENSIONS

DIMENSION STYLE
INCH ONLY

DRAWN BY: T GREGORI
 DATE: 2005/05/17

CHECKED BY: JCOMERCI
 DATE: 2005/05/17

APPROVED BY: JCOMERCI
 DATE: 2010/03/05

MATERIAL NO.

SCALE: 1:1

DESIGN UNITS: INCH

THIRD ANGLE PROJECTION

TITLE: SEARAY RECEPTACLE ASSEMBLY .050 CENTERS

MOLEX INCORPORATED

DOCUMENT NO. SD-45971-001

SHEET NO. 3 OF 10

THIS DRAWING CONTAINS INFORMATION THAT IS PROPRIETARY TO MOLEX INCORPORATED AND SHOULD NOT BE USED WITHOUT WRITTEN PERMISSION

DIM R: (REF)		5.0 MM	6.0 MM	6.5 MM	7.5 MM	8.0 MM
DIM R: HOUSING HEIGHT		.199	.238	.258	.297	.317
POSITION	DIM M	MATERIAL NO	MATERIAL NO	MATERIAL NO	MATERIAL NO	MATERIAL NO
19	1.232	45971-0163	OBSOLETE	45971-0363	OBSOLETE	OBSOLETE
10	0.782	OBSOLETE	OBSOLETE	OBSOLETE	OBSOLETE	OBSOLETE
20	1.282	OBSOLETE	OBSOLETE	OBSOLETE	OBSOLETE	OBSOLETE
30	1.782	OBSOLETE	OBSOLETE	OBSOLETE	OBSOLETE	OBSOLETE
40	2.282	OBSOLETE	OBSOLETE	OBSOLETE	OBSOLETE	OBSOLETE
50	2.782	OBSOLETE	OBSOLETE	OBSOLETE	OBSOLETE	OBSOLETE
15	1.032	OBSOLETE	OBSOLETE	OBSOLETE	OBSOLETE	OBSOLETE
25	1.532	OBSOLETE	OBSOLETE	OBSOLETE	OBSOLETE	OBSOLETE
35	2.032	OBSOLETE	OBSOLETE	OBSOLETE	OBSOLETE	OBSOLETE
45	2.532	OBSOLETE	OBSOLETE	OBSOLETE	OBSOLETE	OBSOLETE

STACK HEIGHTS GIVEN IN METRIC FOR REF ONLY

DIM R: (REF)		5.0 MM	6.0 MM	6.5 MM	7.5 MM	8.0 MM
DIM R: HOUSING HEIGHT		.199	.238	.258	.297	.317
POSITION	DIM M	MATERIAL NO	MATERIAL NO	MATERIAL NO	MATERIAL NO	MATERIAL NO
19	1.232	45971-0167	45971-0267	45971-0367	45971-0467	45971-0567
10	0.782	45971-1167	45971-1267	45971-1367	45971-1467	45971-1567
20	1.282	45971-2167	45971-2267	45971-2367	45971-2467	45971-2567
30	1.782	45971-3167	45971-3267	45971-3367	45971-3467	45971-3567
40	2.282	45971-4167	45971-4267	45971-4367	45971-4467	45971-4567
50	2.782	45971-5167	45971-5267	45971-5367	45971-5467	45971-5567
15	1.032	45971-6167	45971-6267	45971-6367	45971-6467	45971-6567
25	1.532	45971-7167	45971-7267	45971-7367	45971-7467	45971-7567
35	2.032	45971-8167	45971-8267	45971-8367	45971-8467	45971-8567
45	2.532	45971-9167	45971-9267	45971-9367	45971-9467	45971-9567

STACK HEIGHTS GIVEN IN METRIC FOR REF ONLY

NOTES:
1. THIS SHEET CONTAINS THE FOLLOWING OPTIONS
NO OF ROWS: 6
SOLDER CHARGE: TIN / LEAD, 63/Pb 37
PACKAGING: TRAYS AND TAPE AND REEL

SEE SHEET 1 EC NO: UCP2013-0333 DRWN: TREGORI 2012/07/25 CHKD: JCOMERCI APPR: JCOMERCI 2012/07/25	DESCRIPTION REV	GENERAL TOLERANCES (UNLESS SPECIFIED)		DIMENSION STYLE INCH ONLY		SCALE 1:1	DESIGN UNITS INCH	THIRD ANGLE PROJECTION		
			mm	INCH	DRAWN BY TREGORI	DATE 2005/05/17	TITLE SEARAY RECEPTACLE ASSEMBLY .050 CENTERS  MOLEX INCORPORATED			
		4 PLACES	± .005	± .005	CHECKED BY JCOMERCI	DATE 2005/05/17				
		3 PLACES	± .005	± .005	APPROVED BY JCOMERCI	DATE 2010/03/05				
		2 PLACES	± .005	± .005	MATERIAL NO. SEE CHART					
1 PLACE	± .005	± .005	ANGULAR ± .005°		DOCUMENT NO. SD-45971-001	SHEET NO. 4 OF 10				
DRAFT WHERE APPLICABLE MUST REMAIN WITHIN DIMENSIONS			SIZE A		THIS DRAWING CONTAINS INFORMATION THAT IS PROPRIETARY TO MOLEX INCORPORATED AND SHOULD NOT BE USED WITHOUT WRITTEN PERMISSION					

DIM R: (REF)		5.0 MM	6.0 MM	6.5 MM	7.5 MM	8.0 MM
DIM R: HOUSING HEIGHT		.199	.238	.258	.297	.317
POSITION	DIM M	MATERIAL NO	MATERIAL NO	MATERIAL NO	MATERIAL NO	MATERIAL NO
19	1.232	45971-0181	OBSOLETE	45971-0381	OBSOLETE	OBSOLETE
10	0.782	OBSOLETE	OBSOLETE	OBSOLETE	OBSOLETE	OBSOLETE
20	1.282	OBSOLETE	OBSOLETE	OBSOLETE	OBSOLETE	OBSOLETE
30	1.782	OBSOLETE	OBSOLETE	OBSOLETE	OBSOLETE	OBSOLETE
40	2.282	OBSOLETE	OBSOLETE	OBSOLETE	OBSOLETE	OBSOLETE
50	2.782	OBSOLETE	OBSOLETE	OBSOLETE	OBSOLETE	OBSOLETE
15	1.032	OBSOLETE	OBSOLETE	OBSOLETE	OBSOLETE	OBSOLETE
25	1.532	OBSOLETE	OBSOLETE	OBSOLETE	OBSOLETE	OBSOLETE
35	2.032	OBSOLETE	OBSOLETE	OBSOLETE	OBSOLETE	OBSOLETE
45	2.532	OBSOLETE	OBSOLETE	OBSOLETE	OBSOLETE	OBSOLETE

STACK HEIGHTS GIVEN IN METRIC FOR REF ONLY

DIM R: (REF)		5.0 MM	6.0 MM	6.5 MM	7.5 MM	8.0 MM
DIM R: HOUSING HEIGHT		.199	.238	.258	.297	.317
POSITION	DIM M	MATERIAL NO	MATERIAL NO	MATERIAL NO	MATERIAL NO	MATERIAL NO
19	1.232	45971-0185	45971-0285	45971-0385	45971-0485	45971-0585
10	0.782	45971-1185	45971-1285	45971-1385	45971-1485	45971-1585
20	1.282	45971-2185	45971-2285	45971-2385	45971-2485	45971-2585
30	1.782	45971-3185	45971-3285	45971-3385	45971-3485	45971-3585
40	2.282	45971-4185	45971-4285	45971-4385	45971-4485	45971-4585
50	2.782	45971-5185	45971-5285	45971-5385	45971-5485	45971-5585
15	1.032	45971-6185	45971-6285	45971-6385	45971-6485	45971-6585
25	1.532	45971-7185	45971-7285	45971-7385	45971-7485	45971-7585
35	2.032	45971-8185	45971-8285	45971-8385	45971-8485	45971-8585
45	2.532	45971-9185	45971-9285	45971-9385	45971-9485	45971-9585

STACK HEIGHTS GIVEN IN METRIC FOR REF ONLY

NOTES:
1. THIS SHEET CONTAINS THE FOLLOWING OPTIONS
NO OF ROWS: 8
SOLDER CHARGE: TIN, 95.5/ Ag 3.8/ Cu 0.7
PACKAGING: TRAYS AND TAPE AND REEL

SEE SHEET 1 EC NO: UCP2013-0333 DRWN: TREGORI 2012/07/25 CHKD: APPR: JCOMERCI 2012/07/25	DESCRIPTION REV	GENERAL TOLERANCES (UNLESS SPECIFIED)		DIMENSION STYLE INCH ONLY		SCALE 1:1	DESIGN UNITS INCH	THIRD ANGLE PROJECTION			
			mm	INCH	DRAWN BY TREGORI	DATE 2005/05/17	TITLE SEARAY RECEPTACLE ASSEMBLY .050 CENTERS				
		4 PLACES	± ---	± ---	CHECKED BY JCOMERCI	DATE 2005/05/17					
		3 PLACES	± ---	± .005	APPROVED BY JCOMERCI		DATE 2010/03/05	 MOLEX INCORPORATED DOCUMENT NO. SD-45971-001			
		2 PLACES	± ---	± ---	MATERIAL NO.		SHEET NO. 5 OF 10				
1 PLACE	± ---	± ---	DRAFT WHERE APPLICABLE MUST REMAIN WITHIN DIMENSIONS		SIZE A	THIS DRAWING CONTAINS INFORMATION THAT IS PROPRIETARY TO MOLEX INCORPORATED AND SHOULD NOT BE USED WITHOUT WRITTEN PERMISSION					

DIM R: (REF)		5.0 MM	6.0 MM	6.5 MM	7.5 MM	8.0 MM
DIM R: HOUSING HEIGHT		.199	.238	.258	.297	.317
POSITION	DIM M	MATERIAL NO	MATERIAL NO	MATERIAL NO	MATERIAL NO	MATERIAL NO
19	1.232	45971-0183	OBSOLETE	45971-0383	OBSOLETE	OBSOLETE
10	0.782	OBSOLETE	OBSOLETE	OBSOLETE	OBSOLETE	OBSOLETE
20	1.282	OBSOLETE	OBSOLETE	OBSOLETE	OBSOLETE	OBSOLETE
30	1.782	OBSOLETE	OBSOLETE	OBSOLETE	OBSOLETE	OBSOLETE
40	2.282	OBSOLETE	OBSOLETE	OBSOLETE	OBSOLETE	OBSOLETE
50	2.782	OBSOLETE	OBSOLETE	OBSOLETE	OBSOLETE	OBSOLETE
15	1.032	OBSOLETE	OBSOLETE	OBSOLETE	OBSOLETE	OBSOLETE
25	1.532	OBSOLETE	OBSOLETE	OBSOLETE	OBSOLETE	OBSOLETE
35	2.032	OBSOLETE	OBSOLETE	OBSOLETE	OBSOLETE	OBSOLETE
45	2.532	OBSOLETE	OBSOLETE	OBSOLETE	OBSOLETE	OBSOLETE

STACK HEIGHTS GIVEN IN METRIC FOR REF ONLY

DIM R: (REF)		5.0 MM	6.0 MM	6.5 MM	7.5 MM	8.0 MM
DIM R: HOUSING HEIGHT		.199	.238	.258	.297	.317
POSITION	DIM M	MATERIAL NO	MATERIAL NO	MATERIAL NO	MATERIAL NO	MATERIAL NO
19	1.232	45971-0187	45971-0287	45971-0387	45971-0487	45971-0587
10	0.782	45971-1187	45971-1287	45971-1387	45971-1487	45971-1587
20	1.282	45971-2187	45971-2287	45971-2387	45971-2487	45971-2587
30	1.782	45971-3187	45971-3287	45971-3387	45971-3487	45971-3587
40	2.282	45971-4187	45971-4287	45971-4387	45971-4487	45971-4587
50	2.782	45971-5187	45971-5287	45971-5387	45971-5487	45971-5587
15	1.032	45971-6187	45971-6287	45971-6387	45971-6487	45971-6587
25	1.532	45971-7187	45971-7287	45971-7387	45971-7487	45971-7587
35	2.032	45971-8187	45971-8287	45971-8387	45971-8487	45971-8587
45	2.532	45971-9187	45971-9287	45971-9387	45971-9487	45971-9587

STACK HEIGHTS GIVEN IN METRIC FOR REF ONLY

NOTES:
 1. THIS SHEET CONTAINS THE FOLLOWING OPTIONS
 NO OF ROWS: 8
 SOLDER CHARGE: TIN / LEAD, 63/Pb 37
 PACKAGING: TRAYS AND TAPE AND REEL

SEE SHEET 1
 EC NO: UCP2013-0333
 DRWN: TGREGORI 2012/07/25
 CHKD: JCOMERCI
 APPR: JCOMERCI 2012/07/25

DESCRIPTION

GENERAL TOLERANCES (UNLESS SPECIFIED)

	mm	INCH
4 PLACES	± .005	± .0005
3 PLACES	± .005	± .0005
2 PLACES	± .005	± .0005
1 PLACE	± .005	± .0005
ANGULAR ± .005°		

DRAFT WHERE APPLICABLE
 MUST REMAIN
 WITHIN DIMENSIONS

DIMENSION STYLE
INCH ONLY

DRAWN BY	DATE
TGREGORI	2005/05/17
CHECKED BY	DATE
JCOMERCI	2005/05/17
APPROVED BY	DATE
JCOMERCI	2010/03/05

MATERIAL NO.
SEE CHART

SCALE	DESIGN UNITS	THIRD ANGLE PROJECTION
1:1	INCH	THIRD ANGLE PROJECTION

TITLE

**SEARAY
 RECEPTACLE ASSEMBLY
 .050 CENTERS**

MOLEX INCORPORATED

DOCUMENT NO. **SD-45971-001** SHEET NO. **6 OF 10**

THIS DRAWING CONTAINS INFORMATION THAT IS PROPRIETARY TO MOLEX INCORPORATED AND SHOULD NOT BE USED WITHOUT WRITTEN PERMISSION

6		5		4		3	
DIM R: (REF)		5.0 MM		6.0 MM		8.0 MM	
DIM R: HOUSING HEIGHT							
POSITION		MATERIAL NO		MATERIAL NO		MATERIAL NO	
19	1.232	OBSOLETE	OBSOLETE	OBSOLETE	OBSOLETE	OBSOLETE	OBSOLETE
10	0.782	OBSOLETE	OBSOLETE	OBSOLETE	OBSOLETE	OBSOLETE	OBSOLETE
20	1.282	OBSOLETE	OBSOLETE	45971-2311	OBSOLETE	OBSOLETE	OBSOLETE
30	1.782	45971-3111	OBSOLETE	OBSOLETE	OBSOLETE	OBSOLETE	OBSOLETE
40	2.282	OBSOLETE	OBSOLETE	OBSOLETE	45971-4411	OBSOLETE	OBSOLETE
50	2.782	OBSOLETE	OBSOLETE	OBSOLETE	OBSOLETE	OBSOLETE	OBSOLETE
15	1.032	OBSOLETE	OBSOLETE	OBSOLETE	OBSOLETE	OBSOLETE	OBSOLETE
25	1.532	OBSOLETE	OBSOLETE	OBSOLETE	OBSOLETE	OBSOLETE	OBSOLETE
35	2.032	OBSOLETE	OBSOLETE	OBSOLETE	OBSOLETE	OBSOLETE	OBSOLETE
45	2.532	OBSOLETE	OBSOLETE	OBSOLETE	OBSOLETE	OBSOLETE	OBSOLETE

STACK HEIGHTS GIVEN IN METRIC FOR REF ONLY

6		5		4		3	
DIM R: (REF)		5.0 MM		6.0 MM		8.0 MM	
DIM R: HOUSING HEIGHT							
POSITION		MATERIAL NO		MATERIAL NO		MATERIAL NO	
19	1.232	45971-0115	45971-0215	45971-0315	45971-0415	45971-0515	45971-0515
10	0.782	45971-1115	45971-1215	45971-1315	45971-1415	45971-1515	45971-1515
20	1.282	45971-2115	45971-2215	45971-2315	45971-2415	45971-2515	45971-2515
30	1.782	45971-3115	45971-3215	45971-3315	45971-3415	45971-3515	45971-3515
40	2.282	45971-4115	45971-4215	45971-4315	45971-4415	45971-4515	45971-4515
50	2.782	45971-5115	45971-5215	45971-5315	45971-5415	45971-5515	45971-5515
15	1.032	45971-6115	45971-6215	45971-6315	45971-6415	45971-6515	45971-6515
25	1.532	45971-7115	45971-7215	45971-7315	45971-7415	45971-7515	45971-7515
35	2.032	45971-8115	45971-8215	45971-8315	45971-8415	45971-8515	45971-8515
45	2.532	45971-9115	45971-9215	45971-9315	45971-9415	45971-9515	45971-9515

STACK HEIGHTS GIVEN IN METRIC FOR REF ONLY

NOTES:
 1. THIS SHEET CONTAINS THE FOLLOWING OPTIONS
 NO OF ROWS: 10
 SOLDER CHARGE: TIN, 95.5/ Ag 3.8/ Cu 0.7
 PACKAGING: TRAYS AND TAPE AND REEL

SEE SHEET 1
 EC NO: UCP2013-0333
 DRWN: TGREGORI 2012/07/25
 CHKD: JCOMERCI
 APPR: JCOMERCI 2012/07/25

DESCRIPTION

GENERAL TOLERANCES (UNLESS SPECIFIED)

	mm	INCH
4 PLACES	± .005	± .0005
3 PLACES	± .005	± .0005
2 PLACES	± .005	± .0005
1 PLACE	± .005	± .0005
ANGULAR ± .005°		

DRAFT WHERE APPLICABLE
 MUST REMAIN
 WITHIN DIMENSIONS

DIMENSION STYLE
INCH ONLY

DRAWN BY: TGREGORI
 DATE: 2005/05/17

CHECKED BY: JCOMERCI
 DATE: 2005/05/17

APPROVED BY: JCOMERCI
 DATE: 2010/03/05

MATERIAL NO.

SCALE: 1:1

DESIGN UNITS: INCH

THIRD ANGLE PROJECTION

TITLE: SEARAY RECEPTACLE ASSEMBLY .050 CENTERS

MOLEX INCORPORATED

DOCUMENT NO. SD-45971-001

SHEET NO. 7 OF 10

THIS DRAWING CONTAINS INFORMATION THAT IS PROPRIETARY TO MOLEX INCORPORATED AND SHOULD NOT BE USED WITHOUT WRITTEN PERMISSION

DIM R: (REF)		5.0 MM	6.0 MM	6.5 MM	7.5 MM	8.0 MM
DIM R: HOUSING HEIGHT		.199	.238	.258	.297	.317
POSITION	DIM M	MATERIAL NO	MATERIAL NO	MATERIAL NO	MATERIAL NO	MATERIAL NO
19	1.232	OBSOLETE	OBSOLETE	OBSOLETE	OBSOLETE	OBSOLETE
10	0.782	OBSOLETE	OBSOLETE	OBSOLETE	OBSOLETE	OBSOLETE
20	1.282	OBSOLETE	OBSOLETE	45971-2313	OBSOLETE	OBSOLETE
30	1.782	45971-3113	OBSOLETE	OBSOLETE	OBSOLETE	OBSOLETE
40	2.282	OBSOLETE	OBSOLETE	OBSOLETE	45971-4413	OBSOLETE
50	2.782	OBSOLETE	OBSOLETE	OBSOLETE	OBSOLETE	OBSOLETE
15	1.032	OBSOLETE	OBSOLETE	OBSOLETE	OBSOLETE	OBSOLETE
25	1.532	OBSOLETE	OBSOLETE	OBSOLETE	OBSOLETE	OBSOLETE
35	2.032	OBSOLETE	OBSOLETE	OBSOLETE	OBSOLETE	OBSOLETE
45	2.532	OBSOLETE	OBSOLETE	OBSOLETE	OBSOLETE	OBSOLETE

STACK HEIGHTS GIVEN IN METRIC FOR REF ONLY

DIM R: (REF)		5.0 MM	6.0 MM	6.5 MM	7.5 MM	8.0 MM
DIM R: HOUSING HEIGHT		.199	.238	.258	.297	.317
POSITION	DIM M	MATERIAL NO	MATERIAL NO	MATERIAL NO	MATERIAL NO	MATERIAL NO
19	1.232	45971-0117	45971-0217	45971-0317	45971-0417	45971-0517
10	0.782	45971-1117	45971-1217	45971-1317	45971-1417	45971-1517
20	1.282	45971-2117	45971-2217	45971-2317	45971-2417	45971-2517
30	1.782	45971-3117	45971-3217	45971-3317	45971-3417	45971-3517
40	2.282	45971-4117	45971-4217	45971-4317	45971-4417	45971-4517
50	2.782	45971-5117	45971-5217	45971-5317	45971-5417	45971-5517
15	1.032	45971-6117	45971-6217	45971-6317	45971-6417	45971-6517
25	1.532	45971-7117	45971-7217	45971-7317	45971-7417	45971-7517
35	2.032	45971-8117	45971-8217	45971-8317	45971-8417	45971-8517
45	2.532	45971-9117	45971-9217	45971-9317	45971-9417	45971-9517

STACK HEIGHTS GIVEN IN METRIC FOR REF ONLY

NOTES:
 1. THIS SHEET CONTAINS THE FOLLOWING OPTIONS
 NO OF ROWS: 10
 SOLDER CHARGE: TIN / LEAD, 63/Pb 37
 PACKAGING: TRAYS AND TAPE AND REEL

SEE SHEET 1
 EC NO: UCP2013-0333
 DRWN: TGREGORI 2012/07/25
 CHKD: JCOMERCI
 APPR: JCOMERCI 2012/07/25

GENERAL TOLERANCES (UNLESS SPECIFIED)			DIMENSION STYLE INCH ONLY	
	mm	INCH	DRAWN BY	DATE
4 PLACES	± .005	± .0005	TGREGORI	2005/05/17
3 PLACES	± .005	± .0005	CHECKED BY	DATE
2 PLACES	± .005	± .0005	JCOMERCI	2005/05/17
1 PLACE	± .005	± .0005	APPROVED BY	DATE
ANGULAR ± .0005°			JCOMERCI	2010/03/05
DRAFT WHERE APPLICABLE MUST REMAIN WITHIN DIMENSIONS			MATERIAL NO. SEE CHART	

SCALE	DESIGN UNITS	THIRD ANGLE PROJECTION
1:1	INCH	THIRD ANGLE PROJECTION
SEARAY RECEPTACLE ASSEMBLY .050 CENTERS		
MOLEX INCORPORATED		
DOCUMENT NO. SD-45971-001		SHEET NO. 8 OF 10

TRAY PACK PK-45971-001

DIM R: (REF)		5.0 MM	6.0 MM	6.5 MM	7.5 MM	8.0 MM
DIM R: HOUSING HEIGHT		.199	.238	.258	.297	.317
POSITION	DIM M	MATERIAL NO	MATERIAL NO	MATERIAL NO	MATERIAL NO	MATERIAL NO
19	1.232	OBSOLETE	OBSOLETE	OBSOLETE	OBSOLETE	OBSOLETE
10	0.782	OBSOLETE	OBSOLETE	OBSOLETE	OBSOLETE	OBSOLETE
20	1.282	OBSOLETE	OBSOLETE	OBSOLETE	OBSOLETE	OBSOLETE
30	1.782	OBSOLETE	OBSOLETE	OBSOLETE	OBSOLETE	OBSOLETE
40	2.282	OBSOLETE	OBSOLETE	OBSOLETE	OBSOLETE	OBSOLETE
50	2.782	OBSOLETE	OBSOLETE	OBSOLETE	OBSOLETE	OBSOLETE
15	1.032	OBSOLETE	OBSOLETE	OBSOLETE	OBSOLETE	OBSOLETE
25	1.532	OBSOLETE	OBSOLETE	OBSOLETE	OBSOLETE	OBSOLETE
35	2.032	OBSOLETE	OBSOLETE	OBSOLETE	OBSOLETE	OBSOLETE
45	2.532	OBSOLETE	OBSOLETE	OBSOLETE	OBSOLETE	OBSOLETE

STACK HEIGHTS GIVEN IN METRIC FOR REF ONLY

TAPE AND REEL PACK PK-45971-002

DIM R: (REF)		5.0 MM	6.0 MM	6.5 MM	7.5 MM	8.0 MM
DIM R: HOUSING HEIGHT		.199	.238	.258	.297	.317
POSITION	DIM M	MATERIAL NO	MATERIAL NO	MATERIAL NO	MATERIAL NO	MATERIAL NO
19	1.232	45971-0125	45971-0225	45971-0325	45971-0425	45971-0525
10	0.782	45971-1125	45971-1225	45971-1325	45971-1425	45971-1525
20	1.282	45971-2125	45971-2225	45971-2325	45971-2425	45971-2525
30	1.782	45971-3125	45971-3225	45971-3325	45971-3425	45971-3525
40	2.282	45971-4125	45971-4225	45971-4325	45971-4425	45971-4525
50	2.782	45971-5125	45971-5225	45971-5325	45971-5425	45971-5525
15	1.032	45971-6125	45971-6225	45971-6325	45971-6425	45971-6525
25	1.532	45971-7125	45971-7225	45971-7325	45971-7425	45971-7525
35	2.032	45971-8125	45971-8225	45971-8325	45971-8425	45971-8525
45	2.532	45971-9125	45971-9225	45971-9325	45971-9425	45971-9525

STACK HEIGHTS GIVEN IN METRIC FOR REF ONLY

NOTES:
 1. THIS SHEET CONTAINS THE FOLLOWING OPTIONS
 NO OF ROWS: 12
 SOLDER CHARGE: TIN, 95.5/ Ag 3.8/ Cu 0.7
 PACKAGING: TRAYS AND TAPE AND REEL

SEE SHEET 1
 EC NO: UCP2013-0333
 DRWN: TGREGORI 2012/07/25
 CHKD: JCOMERCI
 APPR: JCOMERCI 2012/07/25
 REV DESCRIPTION

GENERAL TOLERANCES (UNLESS SPECIFIED)

	mm	INCH
4 PLACES	± .005	± .0005
3 PLACES	± .005	± .0005
2 PLACES	± .005	± .0005
1 PLACE	± .005	± .0005
ANGULAR ± .005°		

DRAFT WHERE APPLICABLE
MUST REMAIN
WITHIN DIMENSIONS

DIMENSION STYLE
INCH ONLY

DRAWN BY	DATE
TGREGORI	2005/05/17
CHECKED BY	DATE
JCOMERCI	2005/05/17
APPROVED BY	DATE
JCOMERCI	2010/03/05

MATERIAL NO. **SEE CHART**

SCALE	DESIGN UNITS	THIRD ANGLE PROJECTION
3:1	INCH	THIRD ANGLE PROJECTION
TITLE		
SEARAY RECEPTACLE ASSEMBLY .050 CENTERS		
MOLEX INCORPORATED		
DOCUMENT NO.	SHEET NO.	
SD-45971-001	9 OF 10	

THIS DRAWING CONTAINS INFORMATION THAT IS PROPRIETARY TO MOLEX INCORPORATED AND SHOULD NOT BE USED WITHOUT WRITTEN PERMISSION

6		5		4		3		2		1		
DIM R: (REF)		5.0 MM		6.0 MM		6.5 MM		7.5 MM		8.0 MM		STACK HEIGHTS GIVEN IN METRIC FOR REF ONLY
DIM R: HOUSING HEIGHT												
		.199		.238		.258		.297		.317		
POSITION	DIM M	MATERIAL NO	MATERIAL NO	MATERIAL NO	MATERIAL NO	MATERIAL NO	MATERIAL NO	MATERIAL NO	MATERIAL NO	MATERIAL NO		
19	1.232	OBSOLETE	OBSOLETE	OBSOLETE	OBSOLETE	OBSOLETE	OBSOLETE	OBSOLETE	OBSOLETE	OBSOLETE		
10	0.782	OBSOLETE	OBSOLETE	OBSOLETE	OBSOLETE	OBSOLETE	OBSOLETE	OBSOLETE	OBSOLETE	OBSOLETE		
20	1.282	OBSOLETE	OBSOLETE	OBSOLETE	OBSOLETE	OBSOLETE	OBSOLETE	OBSOLETE	OBSOLETE	OBSOLETE		
30	1.782	OBSOLETE	OBSOLETE	OBSOLETE	OBSOLETE	OBSOLETE	OBSOLETE	OBSOLETE	OBSOLETE	OBSOLETE		
40	2.282	OBSOLETE	OBSOLETE	OBSOLETE	OBSOLETE	OBSOLETE	OBSOLETE	OBSOLETE	OBSOLETE	OBSOLETE		
50	2.782	OBSOLETE	OBSOLETE	OBSOLETE	OBSOLETE	OBSOLETE	OBSOLETE	OBSOLETE	OBSOLETE	OBSOLETE		
15	1.032	OBSOLETE	OBSOLETE	OBSOLETE	OBSOLETE	OBSOLETE	OBSOLETE	OBSOLETE	OBSOLETE	OBSOLETE		
25	1.532	OBSOLETE	OBSOLETE	OBSOLETE	OBSOLETE	OBSOLETE	OBSOLETE	OBSOLETE	OBSOLETE	OBSOLETE		
35	2.032	OBSOLETE	OBSOLETE	OBSOLETE	OBSOLETE	OBSOLETE	OBSOLETE	OBSOLETE	OBSOLETE	OBSOLETE		
45	2.532	OBSOLETE	OBSOLETE	OBSOLETE	OBSOLETE	OBSOLETE	OBSOLETE	OBSOLETE	OBSOLETE	OBSOLETE		

6		5		4		3		2		1		
DIM R: (REF)		5.0 MM		6.0 MM		6.5 MM		7.5 MM		8.0 MM		STACK HEIGHTS GIVEN IN METRIC FOR REF ONLY
DIM R: HOUSING HEIGHT												
		.199		.238		.258		.297		.317		
POSITION	DIM M	MATERIAL NO	MATERIAL NO	MATERIAL NO	MATERIAL NO	MATERIAL NO	MATERIAL NO	MATERIAL NO	MATERIAL NO	MATERIAL NO		
19	1.232	45971-0127	45971-0227	45971-0327	45971-0427	45971-0527	45971-0627	45971-0727	45971-0827	45971-0927		
10	0.782	45971-1127	45971-1227	45971-1327	45971-1427	45971-1527	45971-1627	45971-1727	45971-1827	45971-1927		
20	1.282	45971-2127	45971-2227	45971-2327	45971-2427	45971-2527	45971-2627	45971-2727	45971-2827	45971-2927		
30	1.782	45971-3127	45971-3227	45971-3327	45971-3427	45971-3527	45971-3627	45971-3727	45971-3827	45971-3927		
40	2.282	45971-4127	45971-4227	45971-4327	45971-4427	45971-4527	45971-4627	45971-4727	45971-4827	45971-4927		
50	2.782	45971-5127	45971-5227	45971-5327	45971-5427	45971-5527	45971-5627	45971-5727	45971-5827	45971-5927		
15	1.032	45971-6127	45971-6227	45971-6327	45971-6427	45971-6527	45971-6627	45971-6727	45971-6827	45971-6927		
25	1.532	45971-7127	45971-7227	45971-7327	45971-7427	45971-7527	45971-7627	45971-7727	45971-7827	45971-7927		
35	2.032	45971-8127	45971-8227	45971-8327	45971-8427	45971-8527	45971-8627	45971-8727	45971-8827	45971-8927		
45	2.532	45971-9127	45971-9227	45971-9327	45971-9427	45971-9527	45971-9627	45971-9727	45971-9827	45971-9927		

NOTES:
 1. THIS SHEET CONTAINS THE FOLLOWING OPTIONS
 NO OF ROWS: 12
 SOLDER CHARGE: TIN / LEAD, 63/Pb 37
 PACKAGING: TRAYS AND TAPE AND REEL

SEE SHEET 1 EC NO: UCP2013-0333 DRWN: TGREGORI 2012/07/25 CHKD: JCOMERCI 2012/07/25 APPR: JCOMERCI 2012/07/25 REV	GENERAL TOLERANCES (UNLESS SPECIFIED)		DIMENSION STYLE INCH ONLY		SCALE 1:1	DESIGN UNITS INCH	THIRD ANGLE PROJECTION		
		mm	INCH	DRAWN BY TGREGORI	DATE 2005/05/17	TITLE SEARAY RECEPTACLE ASSEMBLY .050 CENTERS			
	4 PLACES	± .005	± .005	CHECKED BY JCOMERCI	DATE 2005/05/17				
	3 PLACES	± .005	± .005	APPROVED BY JCOMERCI	DATE 2010/03/05				
	2 PLACES	± .005	± .005	ANGULAR ± .005°		MATERIAL NO.		DOCUMENT NO.	
1 PLACE	± .005	± .005	DRAFT WHERE APPLICABLE MUST REMAIN WITHIN DIMENSIONS		SEE CHART		SHEET NO. 10 OF 10		



Компания «ЭлектроПласт» предлагает заключение долгосрочных отношений при поставках импортных электронных компонентов на взаимовыгодных условиях!

Наши преимущества:

- Оперативные поставки широкого спектра электронных компонентов отечественного и импортного производства напрямую от производителей и с крупнейших мировых складов;
- Поставка более 17-ти миллионов наименований электронных компонентов;
- Поставка сложных, дефицитных, либо снятых с производства позиций;
- Оперативные сроки поставки под заказ (от 5 рабочих дней);
- Экспресс доставка в любую точку России;
- Техническая поддержка проекта, помощь в подборе аналогов, поставка прототипов;
- Система менеджмента качества сертифицирована по Международному стандарту ISO 9001;
- Лицензия ФСБ на осуществление работ с использованием сведений, составляющих государственную тайну;
- Поставка специализированных компонентов (Xilinx, Altera, Analog Devices, Intersil, Interpoint, Microsemi, Aeroflex, Peregrine, Syfer, Eurofarad, Texas Instrument, Miteq, Cobham, E2V, MA-COM, Hittite, Mini-Circuits, General Dynamics и др.);

Помимо этого, одним из направлений компании «ЭлектроПласт» является направление «Источники питания». Мы предлагаем Вам помощь Конструкторского отдела:

- Подбор оптимального решения, техническое обоснование при выборе компонента;
- Подбор аналогов;
- Консультации по применению компонента;
- Поставка образцов и прототипов;
- Техническая поддержка проекта;
- Защита от снятия компонента с производства.



Как с нами связаться

Телефон: 8 (812) 309 58 32 (многоканальный)

Факс: 8 (812) 320-02-42

Электронная почта: org@eplast1.ru

Адрес: 198099, г. Санкт-Петербург, ул. Калинина, дом 2, корпус 4, литера А.