

ADR520/ADR525/ADR530/ADR540/ADR550

FEATURES

- Ultracompact SC70 and SOT-23-3 packages
- Temperature coefficient: 40 ppm/°C (maximum)
- 2× the temperature coefficient improvement over the LM4040
- Pin compatible with the LM4040/LM4050
- Initial accuracy: ±0.2%
- Low output voltage noise: 14 μV p-p @ 2.5 V output
- No external capacitor required
- Operating current range: 50 μA to 15 mA
- Industrial temperature range: -40°C to +85°C

APPLICATIONS

- Portable, battery-powered equipment
- Automotive
- Power supplies
- Data acquisition systems
- Instrumentation and process control
- Energy measurement

Table 1. Selection Guide

Part	Voltage (V)	Initial Accuracy (%)	Temperature Coefficient (ppm/°C)
ADR520A	2.048	±0.4	70
ADR520B	2.048	±0.2	40
ADR525A	2.5	±0.4	70
ADR525B	2.5	±0.2	40
ADR530A	3.0	±0.4	70
ADR530B	3.0	±0.2	40
ADR540A	4.096	±0.4	70
ADR540B	4.096	±0.2	40
ADR550A	5.0	±0.4	70
ADR550B	5.0	±0.2	40

PIN CONFIGURATION

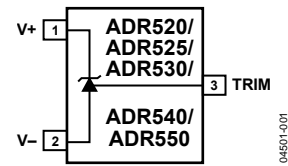

Figure 1. 3-Lead SC70 (KS) and 3-Lead SOT-23-3 (RT)

GENERAL DESCRIPTION

Designed for space-critical applications, the ADR520/ADR525/ADR530/ADR540/ADR550 are high precision shunt voltage references, housed in ultrasmall SC70 and SOT-23-3 packages. These references feature low temperature drift of 40 ppm/°C, an initial accuracy of better than ±0.2%, and ultralow output noise of 14 μV p-p.

Available in output voltages of 2.048 V, 2.5 V, 3.0 V, 4.096 V, and 5.0 V, the advanced design of the ADR520/ADR525/ADR530/ADR540/ADR550 eliminates the need for compensation by an external capacitor, yet the references are stable with any capacitive load. The minimum operating current increases from a mere 50 μA to a maximum of 15 mA. This low operating current and ease of use make these references ideally suited for handheld, battery-powered applications.

A trim terminal is available on the ADR520/ADR525/ADR530/ADR540/ADR550 to allow adjustment of the output voltage over a ±0.5% range, without affecting the temperature coefficient of the device. This feature provides users with the flexibility to trim out any system errors.

Rev. E

Information furnished by Analog Devices is believed to be accurate and reliable. However, no responsibility is assumed by Analog Devices for its use, nor for any infringements of patents or other rights of third parties that may result from its use. Specifications subject to change without notice. No license is granted by implication or otherwise under any patent or patent rights of Analog Devices. Trademarks and registered trademarks are the property of their respective owners.

TABLE OF CONTENTS

Features	1	Absolute Maximum Ratings	6
Applications.....	1	Thermal Resistance.....	6
Pin Configuration.....	1	ESD Caution.....	6
General Description	1	Parameter Definitions.....	7
Revision History	2	Temperature Coefficient.....	7
Specifications.....	3	Thermal Hysteresis	7
ADR520 Electrical Characteristics.....	3	Typical Performance Characteristics	8
ADR525 Electrical Characteristics.....	3	Theory of Operation	11
ADR530 Electrical Characteristics.....	4	Applications	11
ADR540 Electrical Characteristics.....	4	Outline Dimensions	13
ADR550 Electrical Characteristics.....	5	Ordering Guide	14

REVISION HISTORY

6/08—Rev. D to Rev. E

Changes to Table 3.....	3
Changes to Table 4 and Table 5.....	4
Changes to Table 6.....	5
Changes to Figure 4.....	8
Changes to Applications Section	11

12/07—Rev. C to Rev. D

Changes to Figure 3 and Figure 5.....	8
Changes to Figure 15, Figure 16, and Figure 17 Captions	10
Changes to Figure 23.....	12
Updated Outline Dimensions	13

8/07—Rev. B to Rev. C

Changes to Figure 21.....	11
Updated Outline Dimensions	13
Changes to Ordering Guide	14

1/06—Rev. A to Rev. B

Updated Formatting.....	Universal
Changes to Features Section	1
Changes to General Description Section	1
Updated Outline Dimensions.....	13
Changes to Ordering Guide	14

12/03—Data Sheet Changed from Rev. 0 to Rev. A

Updated Outline Dimensions.....	13
Change to Ordering Guide.....	14

11/03—Revision 0: Initial Version

SPECIFICATIONS

ADR520 ELECTRICAL CHARACTERISTICS

$I_{IN} = 50 \mu\text{A}$ to 15 mA, $T_A = 25^\circ\text{C}$, unless otherwise noted.

Table 2.

Parameter	Symbol	Conditions	Min	Typ	Max	Unit
Output Voltage	V_{OUT}					
Grade A			2.040	2.048	2.056	V
Grade B			2.044	2.048	2.052	V
Initial Accuracy	V_{OERR}					
Grade A		$\pm 0.4\%$	-8		+8	mV
Grade B		$\pm 0.2\%$	-4		+4	mV
Temperature Coefficient ¹	TCV_O	$-40^\circ\text{C} < T_A < +85^\circ\text{C}$				
Grade A				25	70	ppm/ $^\circ\text{C}$
Grade B				15	40	ppm/ $^\circ\text{C}$
Output Voltage Change vs. I_{IN}	ΔV_R	$I_{IN} = 0.1 \text{ mA to } 15 \text{ mA}$ $-40^\circ\text{C} < T_A < +85^\circ\text{C}$			1	mV
		$I_{IN} = 1 \text{ mA to } 15 \text{ mA}$ $-40^\circ\text{C} < T_A < +85^\circ\text{C}$			4	mV
		$I_{IN} = 0.1 \text{ mA to } 15 \text{ mA}$ $-40^\circ\text{C} < T_A < +85^\circ\text{C}$			2	mV
Dynamic Output Impedance	$(\Delta V_R / \Delta I_R)$	$I_{IN} = 0.1 \text{ mA to } 15 \text{ mA}$ $-40^\circ\text{C} < T_A < +85^\circ\text{C}$			0.27	Ω
Minimum Operating Current	I_{IN}	$-40^\circ\text{C} < T_A < +85^\circ\text{C}$	50			μA
Voltage Noise	$e_{N \text{ p-p}}$	0.1 Hz to 10 Hz		14		$\mu\text{V p-p}$
Turn-On Settling Time	t_R			2		μs
Output Voltage Hysteresis	ΔV_{OUT_HYS}	$I_{IN} = 1 \text{ mA}$		40		ppm

¹ Guaranteed by design; not production tested.

ADR525 ELECTRICAL CHARACTERISTICS

$I_{IN} = 50 \mu\text{A}$ to 15 mA, $T_A = 25^\circ\text{C}$, unless otherwise noted.

Table 3.

Parameter	Symbol	Conditions	Min	Typ	Max	Unit
Output Voltage	V_{OUT}					
Grade A			2.490	2.500	2.510	V
Grade B			2.495	2.500	2.505	V
Initial Accuracy	V_{OERR}					
Grade A		$\pm 0.4\%$	-10		+10	mV
Grade B		$\pm 0.2\%$	-5		+5	mV
Temperature Coefficient ¹	TCV_O	$-40^\circ\text{C} < T_A < +85^\circ\text{C}$				
Grade A				25	70	ppm/ $^\circ\text{C}$
Grade B				15	40	ppm/ $^\circ\text{C}$
Output Voltage Change vs. I_{IN}	ΔV_R	$I_{IN} = 0.1 \text{ mA to } 15 \text{ mA}$ $-40^\circ\text{C} < T_A < +85^\circ\text{C}$			1	mV
		$I_{IN} = 1 \text{ mA to } 15 \text{ mA}$ $-40^\circ\text{C} < T_A < +85^\circ\text{C}$			4	mV
		$I_{IN} = 0.1 \text{ mA to } 15 \text{ mA}$ $-40^\circ\text{C} < T_A < +85^\circ\text{C}$			2	mV
Dynamic Output Impedance	$(\Delta V_R / \Delta I_R)$	$I_{IN} = 0.1 \text{ mA to } 15 \text{ mA}$ $-40^\circ\text{C} < T_A < +85^\circ\text{C}$			0.2	Ω
Minimum Operating Current	I_{IN}	$-40^\circ\text{C} < T_A < +85^\circ\text{C}$	50			μA
Voltage Noise	$e_{N \text{ p-p}}$	0.1 Hz to 10 Hz		18		$\mu\text{V p-p}$
Turn-On Settling Time	t_R			2		μs
Output Voltage Hysteresis	ΔV_{OUT_HYS}	$I_{IN} = 1 \text{ mA}$		40		ppm

¹ Guaranteed by design; not production tested.

ADR520/ADR525/ADR530/ADR540/ADR550

ADR530 ELECTRICAL CHARACTERISTICS

$I_{IN} = 50 \mu\text{A}$ to 15 mA, $T_A = 25^\circ\text{C}$, unless otherwise noted.

Table 4.

Parameter	Symbol	Conditions	Min	Typ	Max	Unit
Output Voltage	V_{OUT}					
Grade A			2.988	3.000	3.012	V
Grade B			2.994	3.000	3.006	V
Initial Accuracy	V_{OERR}					
Grade A		$\pm 0.4\%$	-12		+12	mV
Grade B		$\pm 0.2\%$	-6		+6	mV
Temperature Coefficient ¹	TCV_O	$-40^\circ\text{C} < T_A < +85^\circ\text{C}$				
Grade A				25	70	ppm/ $^\circ\text{C}$
Grade B				15	40	ppm/ $^\circ\text{C}$
Output Voltage Change vs. I_{IN}	ΔV_R	$I_{IN} = 0.1 \text{ mA to } 15 \text{ mA}$ $-40^\circ\text{C} < T_A < +85^\circ\text{C}$			1	mV
		$I_{IN} = 1 \text{ mA to } 15 \text{ mA}$ $-40^\circ\text{C} < T_A < +85^\circ\text{C}$			4	mV
		$I_{IN} = 0.1 \text{ mA to } 15 \text{ mA}$ $-40^\circ\text{C} < T_A < +85^\circ\text{C}$			2	mV
Dynamic Output Impedance	$(\Delta V_R / \Delta I_R)$	$I_{IN} = 0.1 \text{ mA to } 15 \text{ mA}$ $-40^\circ\text{C} < T_A < +85^\circ\text{C}$			0.2	Ω
Minimum Operating Current	I_{IN}	$-40^\circ\text{C} < T_A < +85^\circ\text{C}$	50			μA
Voltage Noise	$e_{N \text{ p-p}}$	0.1 Hz to 10 Hz		22		$\mu\text{V p-p}$
Turn-On Settling Time	t_R			2		μs
Output Voltage Hysteresis	ΔV_{OUT_HYS}	$I_{IN} = 1 \text{ mA}$		40		ppm

¹ Guaranteed by design; not production tested.

ADR540 ELECTRICAL CHARACTERISTICS

$I_{IN} = 50 \mu\text{A}$ to 15 mA, $T_A = 25^\circ\text{C}$, unless otherwise noted.

Table 5.

Parameter	Symbol	Conditions	Min	Typ	Max	Unit
Output Voltage	V_{OUT}					
Grade A			4.080	4.096	4.112	V
Grade B			4.088	4.096	4.104	V
Initial Accuracy	V_{OERR}					
Grade A		$\pm 0.4\%$	-16		+16	mV
Grade B		$\pm 0.2\%$	-8		+8	mV
Temperature Coefficient ¹	TCV_O	$-40^\circ\text{C} < T_A < +85^\circ\text{C}$				
Grade A				25	70	ppm/ $^\circ\text{C}$
Grade B				15	40	ppm/ $^\circ\text{C}$
Output Voltage Change vs. I_{IN}	ΔV_R	$I_{IN} = 0.1 \text{ mA to } 15 \text{ mA}$ $-40^\circ\text{C} < T_A < +85^\circ\text{C}$			1	mV
		$I_{IN} = 1 \text{ mA to } 15 \text{ mA}$ $-40^\circ\text{C} < T_A < +85^\circ\text{C}$			5	mV
		$I_{IN} = 0.1 \text{ mA to } 15 \text{ mA}$ $-40^\circ\text{C} < T_A < +85^\circ\text{C}$			2	mV
Dynamic Output Impedance	$(\Delta V_R / \Delta I_R)$	$I_{IN} = 0.1 \text{ mA to } 15 \text{ mA}$ $-40^\circ\text{C} < T_A < +85^\circ\text{C}$			0.2	Ω
Minimum Operating Current	I_{IN}	$-40^\circ\text{C} < T_A < +85^\circ\text{C}$	50			μA
Voltage Noise	$e_{N \text{ p-p}}$	0.1 Hz to 10 Hz		30		$\mu\text{V p-p}$
Turn-On Settling Time	t_R			2		μs
Output Voltage Hysteresis	ΔV_{OUT_HYS}	$I_{IN} = 1 \text{ mA}$		40		ppm

¹ Guaranteed by design; not production tested.

ADR550 ELECTRICAL CHARACTERISTICS

$I_{IN} = 50 \mu\text{A}$ to 15 mA, $T_A = 25^\circ\text{C}$, unless otherwise noted.

Table 6.

Parameter	Symbol	Conditions	Min	Typ	Max	Unit
Output Voltage	V_{OUT}					
Grade A			4.980	5.000	5.020	V
Grade B			4.990	5.000	5.010	V
Initial Accuracy	V_{OERR}					
Grade A		$\pm 0.4\%$	-20		+20	mV
Grade B		$\pm 0.2\%$	-10		+10	mV
Temperature Coefficient ¹	TCV_O	$-40^\circ\text{C} < T_A < +85^\circ\text{C}$				
Grade A				25	70	ppm/ $^\circ\text{C}$
Grade B				15	40	ppm/ $^\circ\text{C}$
Output Voltage Change vs. I_{IN}	ΔV_R	$I_{IN} = 0.1 \text{ mA to } 15 \text{ mA}$ $-40^\circ\text{C} < T_A < +85^\circ\text{C}$			1	mV
		$I_{IN} = 1 \text{ mA to } 15 \text{ mA}$ $-40^\circ\text{C} < T_A < +85^\circ\text{C}$			5	mV
		$I_{IN} = 0.1 \text{ mA to } 15 \text{ mA}$ $-40^\circ\text{C} < T_A < +85^\circ\text{C}$			2	mV
Dynamic Output Impedance	$(\Delta V_R / \Delta I_R)$	$I_{IN} = 0.1 \text{ mA to } 15 \text{ mA}$ $-40^\circ\text{C} < T_A < +85^\circ\text{C}$			0.2	Ω
Minimum Operating Current	I_{IN}	$-40^\circ\text{C} < T_A < +85^\circ\text{C}$	50			μA
Voltage Noise	$e_{N \text{ p-p}}$	0.1 Hz to 10 Hz		38		$\mu\text{V p-p}$
Turn-On Settling Time	t_R			2		μs
Output Voltage Hysteresis	ΔV_{OUT_HYS}	$I_{IN} = 1 \text{ mA}$		40		ppm

¹ Guaranteed by design; not production tested.

ADR520/ADR525/ADR530/ADR540/ADR550

ABSOLUTE MAXIMUM RATINGS

Ratings apply at 25°C, unless otherwise noted.

Table 7.

Parameter	Rating
Reverse Current	25 mA
Forward Current	20 mA
Storage Temperature Range	–65°C to +150°C
Industrial Temperature Range	–40°C to +85°C
Junction Temperature Range	–65°C to +150°C
Lead Temperature (Soldering, 60 sec)	300°C

Stresses above those listed under Absolute Maximum Ratings may cause permanent damage to the device. This is a stress rating only; functional operation of the device at these or any other conditions above those indicated in the operational section of this specification is not implied. Exposure to absolute maximum rating conditions for extended periods may affect device reliability.

THERMAL RESISTANCE

Table 8.

Package Type	θ_{JA}^1	θ_{JC}	Unit
3-Lead SC70 (KS)	580.5	177.4	°C/W
3-Lead SOT-23-3 (RT)	270	102	°C/W

¹ θ_{JA} is specified for worst-case conditions, such as for devices soldered on circuit boards for surface-mount packages.

ESD CAUTION



ESD (electrostatic discharge) sensitive device. Charged devices and circuit boards can discharge without detection. Although this product features patented or proprietary protection circuitry, damage may occur on devices subjected to high energy ESD. Therefore, proper ESD precautions should be taken to avoid performance degradation or loss of functionality.

PARAMETER DEFINITIONS

TEMPERATURE COEFFICIENT

Temperature coefficient is defined as the change in output voltage with respect to operating temperature changes and is normalized by the output voltage at 25°C. This parameter is expressed in ppm/°C and is determined by the following equation:

$$TCV_o \left[\frac{\text{ppm}}{^\circ\text{C}} \right] = \frac{V_{OUT}(T_2) - V_{OUT}(T_1)}{V_{OUT}(25^\circ\text{C}) \times (T_2 - T_1)} \times 10^6 \quad (1)$$

where:

$V_{OUT}(T_2) = V_{OUT}$ at Temperature 2.

$V_{OUT}(T_1) = V_{OUT}$ at Temperature 1.

$V_{OUT}(25^\circ\text{C}) = V_{OUT}$ at 25°C.

THERMAL HYSTERESIS

Thermal hysteresis is defined as the change in output voltage after the device is cycled through temperatures ranging from +25°C to -40°C, then to +85°C, and back to +25°C. The following equation expresses a typical value from a sample of parts put through such a cycle:

$$V_{OUT_HYS} = V_{OUT}(25^\circ\text{C}) - V_{OUT_END}$$

$$V_{OUT_HYS}[\text{ppm}] = \frac{V_{OUT}(25^\circ\text{C}) - V_{OUT_END}}{V_{OUT}(25^\circ\text{C})} \times 10^6 \quad (2)$$

where:

$V_{OUT}(25^\circ\text{C}) = V_{OUT}$ at 25°C.

$V_{OUT_END} = V_{OUT}$ at 25°C after a temperature cycle from +25°C to -40°C, then to +85°C, and back to +25°C.

TYPICAL PERFORMANCE CHARACTERISTICS

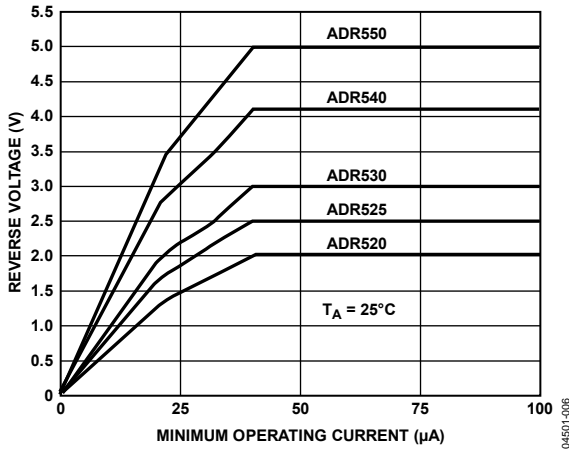

Figure 2. Reverse Characteristics and Minimum Operating Current

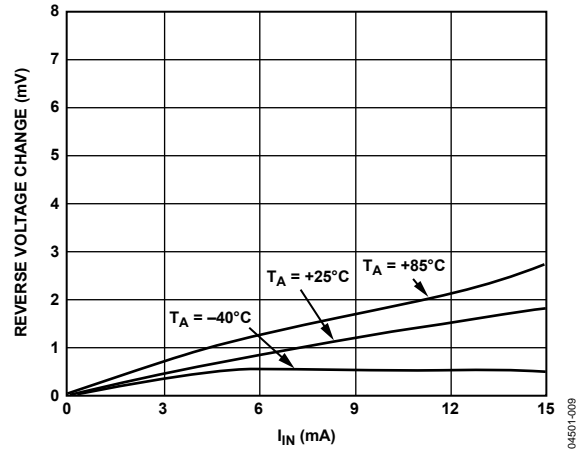

Figure 5. ADR550 Reverse Voltage vs. Operating Current

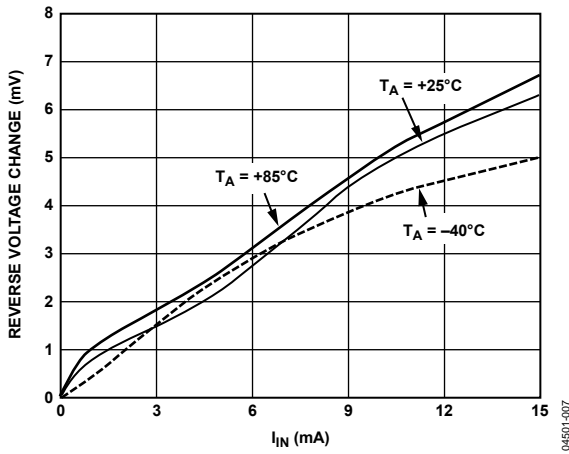

Figure 3. ADR520 Reverse Voltage vs. Operating Current

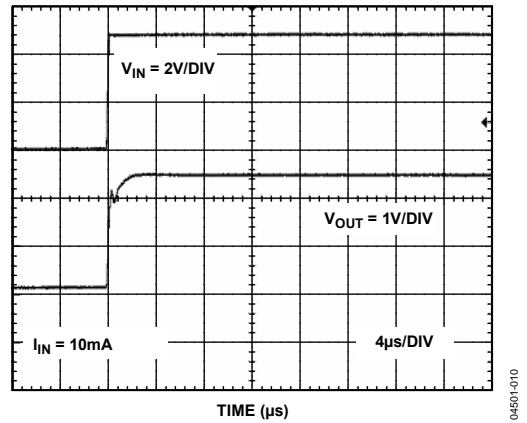

Figure 6. ADR525 Turn-On Response

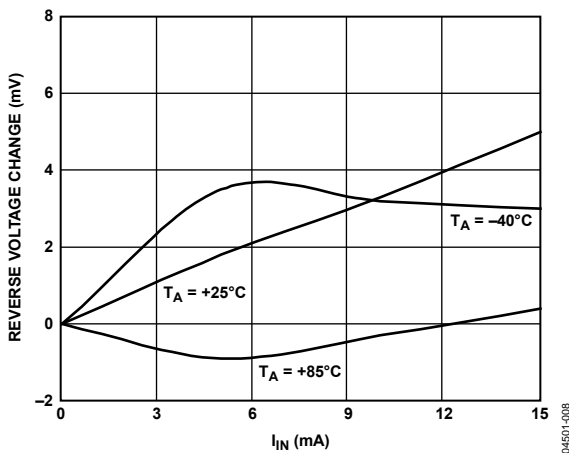

Figure 4. ADR525 Reverse Voltage vs. Operating Current

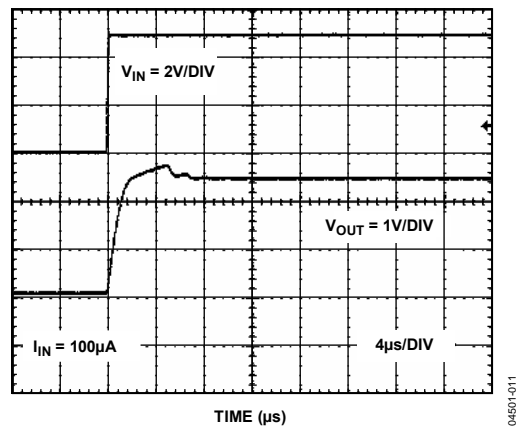

Figure 7. ADR525 Turn-On Response

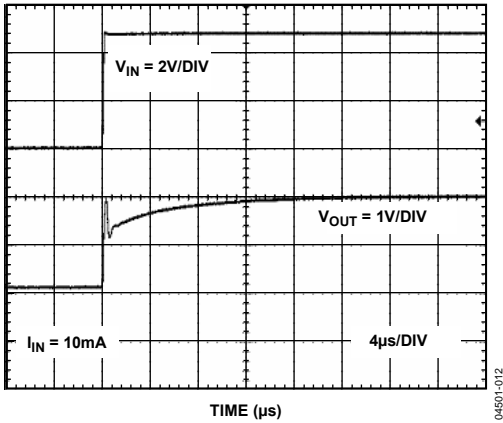

Figure 8. ADR520 Turn-On Response

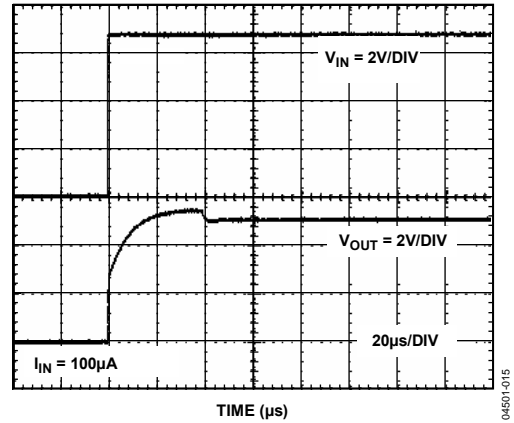

Figure 11. ADR550 Turn-On Response

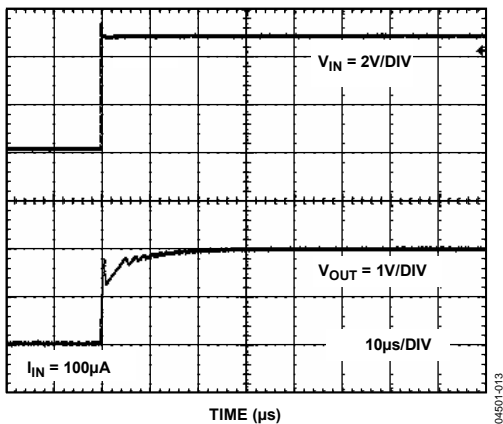

Figure 9. ADR520 Turn-On Response

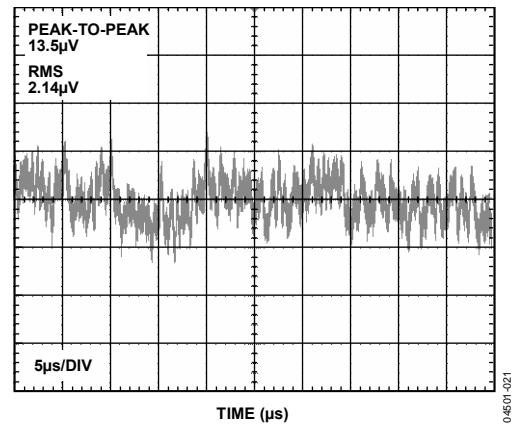

Figure 12. ADR520 Voltage Noise 0.1 Hz to 10 Hz

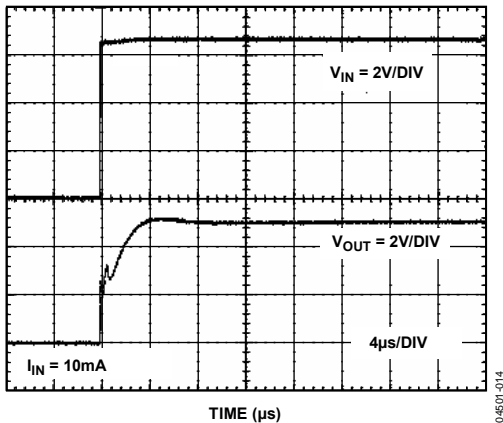

Figure 10. ADR550 Turn-On Response

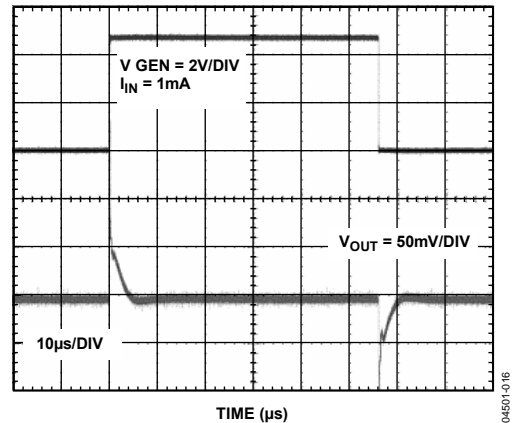

Figure 13. ADR525 Load Transient Response

ADR520/ADR525/ADR530/ADR540/ADR550

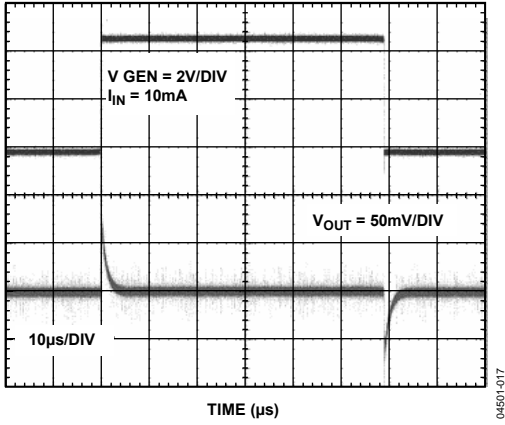

Figure 14. ADR550 Load Transient Response

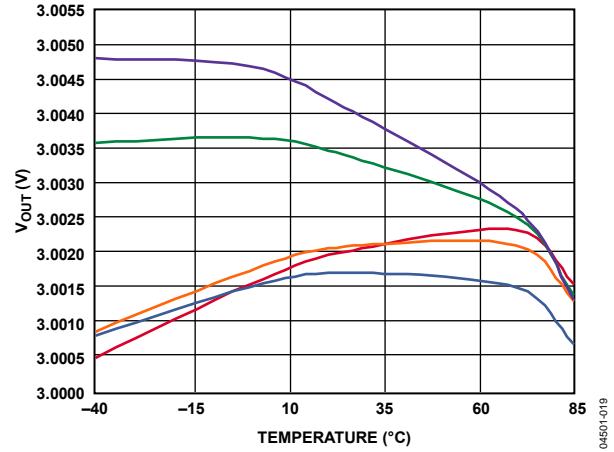

Figure 16. Data for Five Parts of ADR530 V_{OUT} over Temperature

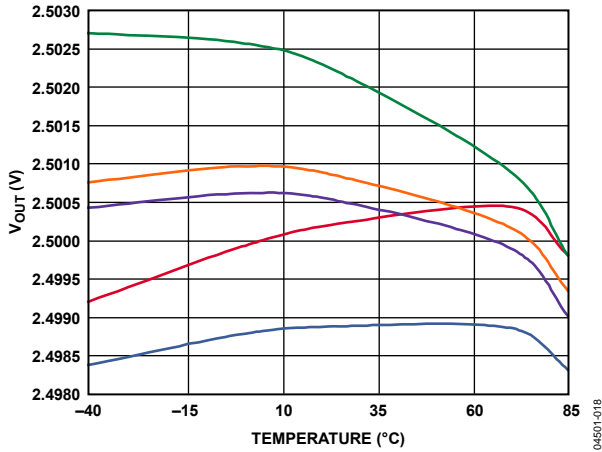

Figure 15. Data for Five Parts of ADR525 V_{OUT} over Temperature

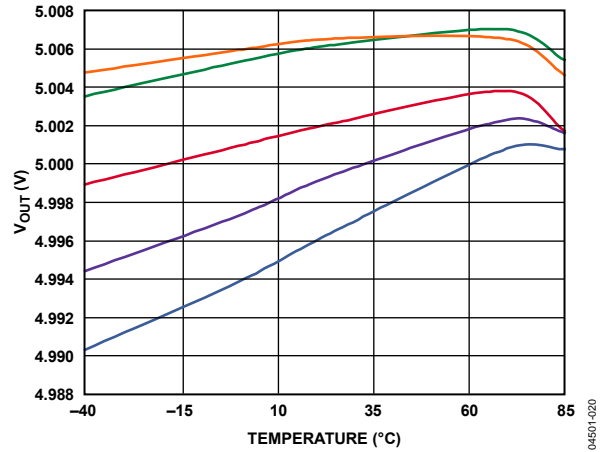

Figure 17. Data for Five Parts of ADR550 V_{OUT} over Temperature

THEORY OF OPERATION

The ADR520/ADR525/ADR530/ADR540/ADR550 use the band gap concept to produce a stable, low temperature coefficient voltage reference suitable for high accuracy data acquisition components and systems. The devices use the physical nature of a silicon transistor base-emitter voltage (V_{BE}) in the forward-biased operating region. All such transistors have approximately a $-2\text{ mV}/^\circ\text{C}$ temperature coefficient (TC), making them unsuitable for direct use as low temperature coefficient references. Extrapolation of the temperature characteristics of any one of these devices to absolute zero (with the collector current proportional to the absolute temperature), however, reveals that its V_{BE} approaches approximately the silicon band gap voltage. Thus, if a voltage develops with an opposing temperature coefficient to sum the V_{BE} , a zero temperature coefficient reference results. The ADR520/ADR525/ADR530/ADR540/ADR550 circuit shown in Figure 18 provides such a compensating voltage (V_1) by driving two transistors at different current densities and amplifying the resultant V_{BE} difference (ΔV_{BE} , which has a positive temperature coefficient). The sum of V_{BE} and V_1 provides a stable voltage reference over temperature.

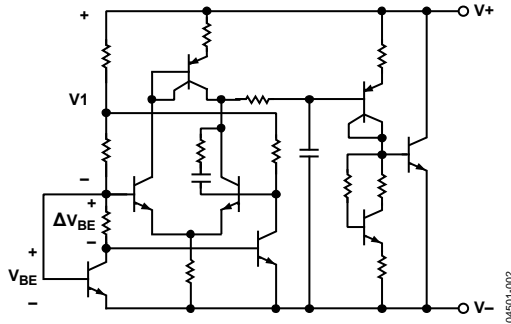

Figure 18. Circuit Schematic

APPLICATIONS

The ADR520/ADR525/ADR530/ADR540/ADR550 are a series of precision shunt voltage references. They are designed to operate without an external capacitor between the positive and negative terminals. If a bypass capacitor is used to filter the supply, the references remain stable.

All shunt voltage references require an external bias resistor (R_{BIAS}) between the supply voltage and the reference (see Figure 19). R_{BIAS} sets the current that flows through the load (I_L) and the reference (I_{IN}). Because the load and the supply voltage can vary, R_{BIAS} needs to be chosen based on the following considerations:

- R_{BIAS} must be small enough to supply the minimum I_{IN} current to the ADR520/ADR525/ADR530/ADR540/ADR550, even when the supply voltage is at its minimum value and the load current is at its maximum value.
- R_{BIAS} must be large enough so that I_{IN} does not exceed 15 mA when the supply voltage is at its maximum value and the load current is at its minimum value.

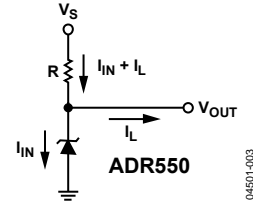

Figure 19. Shunt Reference

Given these conditions, R_{BIAS} is determined by the supply voltage (V_S), the load and operating currents (I_L and I_{IN}) of the ADR520/ADR525/ADR530/ADR540/ADR550, and the output voltage (V_{OUT}) of the ADR520/ADR525/ADR530/ADR540/ADR550.

$$R_{BIAS} = \frac{V_S - V_{OUT}}{I_L + I_{IN}} \quad (3)$$

Precision Negative Voltage Reference

The ADR520/ADR525/ADR530/ADR540/ADR550 are suitable for applications where a precise negative voltage is desired. Figure 20 shows the ADR525 configured to provide a negative output.

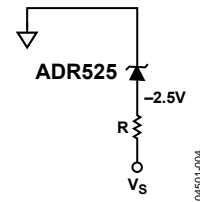

Figure 20. Negative Precision Reference Configuration

Output Voltage Trim

The trim terminal of the ADR520/ADR525/ADR530/ADR540/ADR550 can be used to adjust the output voltage over a range of $\pm 0.5\%$. This allows systems designers to trim system errors by setting the reference to a voltage other than the preset output voltage. An external mechanical or electrical potentiometer can be used for this adjustment. Figure 21 illustrates how the output voltage can be trimmed using the AD5273, an Analog Devices, Inc., 10 kΩ potentiometer.

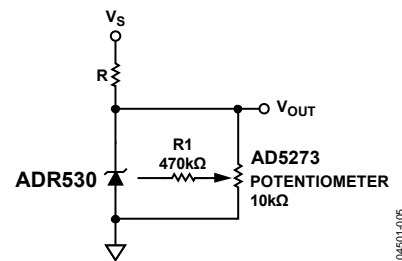

Figure 21. Output Voltage Trim

ADR520/ADR525/ADR530/ADR540/ADR550

Stacking the ADR520/ADR525/ADR530/ADR540/ADR550 for User-Definable Outputs

Multiple ADR520/ADR525/ADR530/ADR540/ADR550 parts can be stacked to allow the user to obtain a desired higher voltage. Figure 22 shows three ADR550s configured to give 15 V. The bias resistor, R_{BIAS} , is chosen using Equation 3; note that the same bias current flows through all the shunt references in series. Figure 23 shows three ADR550s stacked to give -15 V . R_{BIAS} is calculated in the same manner as before. Parts of different voltages can also be added together. For example, an ADR525 and an ADR550 can be added together to give an output of $+7.5\text{ V}$ or -7.5 V , as desired. Note, however, that the initial accuracy error is now the sum of the errors of all the stacked parts, as are the temperature coefficients and output voltage change vs. input current.

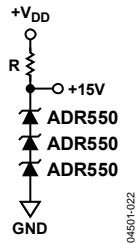

Figure 22. $+15\text{ V}$ Output with Stacked ADR550s

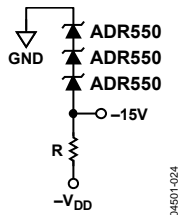

Figure 23. -15 V Output with Stacked ADR550s

Adjustable Precision Voltage Source

The ADR520/ADR525/ADR530/ADR540/ADR550, combined with a precision low input bias op amp, such as the AD8610, can be used to output a precise adjustable voltage. Figure 24 illustrates the implementation of this application using the ADR520/ADR525/ADR530/ADR540/ADR550. The output of the op amp, V_{OUT} , is determined by the gain of the circuit, which is completely dependent on the resistors, R_1 and R_2 .

$$V_{OUT} = V_{REF} (1 + R_2/R_1)$$

An additional capacitor, C_1 , in parallel with R_2 , can be added to filter out high frequency noise. The value of C_1 is dependent on the value of R_2 .

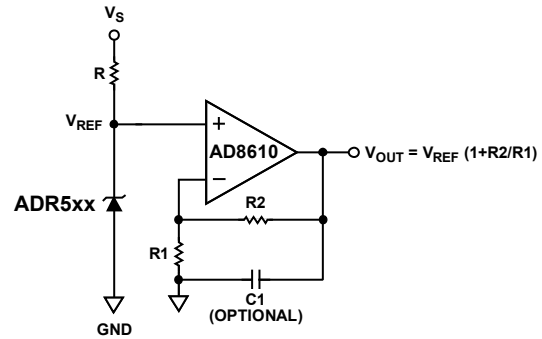
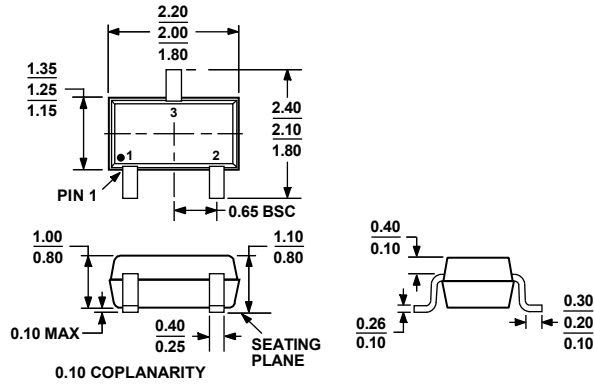

Figure 24. Adjustable Voltage Source

OUTLINE DIMENSIONS



ALL DIMENSIONS COMPLIANT WITH EIAJ SC70

Figure 25. 3-Lead Thin Shrink Small Outline Transistor Package [SC70] (KS-3)

Dimensions shown in millimeters

111905-0

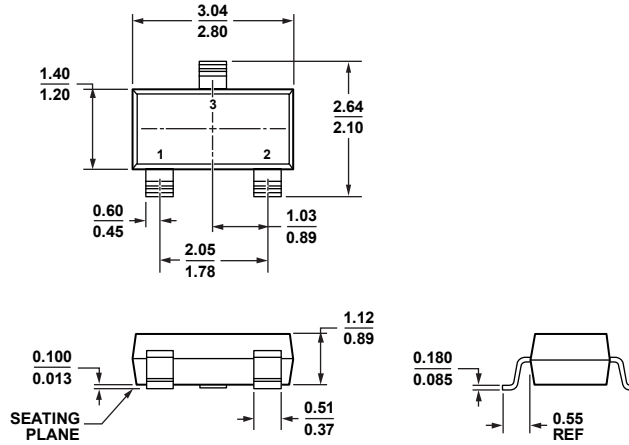

COMPLIANT TO JEDEC STANDARDS TO-236-AB

Figure 26. 3-Lead Small Outline Transistor Package [SOT-23-3] (RT-3)

Dimensions shown in millimeters

092707-A

ADR520/ADR525/ADR530/ADR540/ADR550

ORDERING GUIDE

Model	Output Voltage (V)	Initial Accuracy (mV)	Tempco Industrial (ppm/°C)	Package Description	Package Option	Branding	Number of Parts per Reel	Temperature Range
ADR520ART-R2	2.048	8	70	3-Lead SOT-23-3	RT-3	RQA	250	-40°C to +85°C
ADR520ART-REEL7	2.048	8	70	3-Lead SOT-23-3	RT-3	RQA	3,000	-40°C to +85°C
ADR520ARTZ-REEL7 ¹	2.048	8	70	3-Lead SOT-23-3	RT-3	R1S	3,000	-40°C to +85°C
ADR520BKS-R2	2.048	4	40	3-Lead SC70	KS-3	RQB	250	-40°C to +85°C
ADR520BKS-REEL7	2.048	4	40	3-Lead SC70	KS-3	RQB	3,000	-40°C to +85°C
ADR520BKSZ-REEL7 ¹	2.048	4	40	3-Lead SC70	KS-3	R1T	3,000	-40°C to +85°C
ADR520BRT-R2	2.048	4	40	3-Lead SOT-23-3	RT-3	RQB	250	-40°C to +85°C
ADR520BRT-REEL7	2.048	4	40	3-Lead SOT-23-3	RT-3	RQB	3,000	-40°C to +85°C
ADR520BRTZ-REEL7 ¹	2.048	4	40	3-Lead SOT-23-3	RT-3	R1T	3,000	-40°C to +85°C
ADR525ART-R2	2.5	10	70	3-Lead SOT-23-3	RT-3	RRA	250	-40°C to +85°C
ADR525ART-REEL7	2.5	10	70	3-Lead SOT-23-3	RT-3	RRA	3,000	-40°C to +85°C
ADR525ARTZ-R2 ¹	2.5	10	70	3-Lead SOT-23-3	RT-3	R1W	250	-40°C to +85°C
ADR525ARTZ-REEL7 ¹	2.5	10	70	3-Lead SOT-23-3	RT-3	R1W	3,000	-40°C to +85°C
ADR525BKS-R2	2.5	5	40	3-Lead SC70	KS-3	RRB	250	-40°C to +85°C
ADR525BKS-REEL7	2.5	5	40	3-Lead SC70	KS-3	RRB	3,000	-40°C to +85°C
ADR525BKSZ-REEL7 ¹	2.5	5	40	3-Lead SC70	KS-3	R1N	3,000	-40°C to +85°C
ADR525BRT-R2	2.5	5	40	3-Lead SOT-23-3	RT-3	RRB	250	-40°C to +85°C
ADR525BRT-REEL7	2.5	5	40	3-Lead SOT-23-3	RT-3	RRB	3,000	-40°C to +85°C
ADR525BRTZ-REEL7 ¹	2.5	5	40	3-Lead SOT-23-3	RT-3	R1N	3,000	-40°C to +85°C
ADR530ART-R2	3.0	12	70	3-Lead SOT-23-3	RT-3	RSA	250	-40°C to +85°C
ADR530ART-REEL7	3.0	12	70	3-Lead SOT-23-3	RT-3	RSA	3,000	-40°C to +85°C
ADR530ARTZ-REEL7 ¹	3.0	12	70	3-Lead SOT-23-3	RT-3	R1X	3,000	-40°C to +85°C
ADR530BKS-R2	3.0	6	40	3-Lead SC70	KS-3	RSB	250	-40°C to +85°C
ADR530BKS-REEL7	3.0	6	40	3-Lead SC70	KS-3	RSB	3,000	-40°C to +85°C
ADR530BKSZ-REEL7 ¹	3.0	6	40	3-Lead SC70	KS-3	R1Y	3,000	-40°C to +85°C
ADR530BRT-R2	3.0	6	40	3-Lead SOT-23-3	RT-3	RSB	250	-40°C to +85°C
ADR530BRT-REEL7	3.0	6	40	3-Lead SOT-23-3	RT-3	RSB	3,000	-40°C to +85°C
ADR530BRTZ-REEL7 ¹	3.0	6	40	3-Lead SOT-23-3	RT-3	R1Y	3,000	-40°C to +85°C
ADR540ART-R2	4.096	16	70	3-Lead SOT-23-3	RT-3	RTA	250	-40°C to +85°C
ADR540ART-REEL7	4.096	16	70	3-Lead SOT-23-3	RT-3	RTA	3,000	-40°C to +85°C
ADR540ARTZ-REEL7 ¹	4.096	16	70	3-Lead SOT-23-3	RT-3	R1U	3,000	-40°C to +85°C
ADR540BKS-R2	4.096	8	40	3-Lead SC70	KS-3	RTB	250	-40°C to +85°C
ADR540BKS-REEL7	4.096	8	40	3-Lead SC70	KS-3	RTB	3,000	-40°C to +85°C
ADR540BKSZ-REEL7 ¹	4.096	8	40	3-Lead SC70	KS-3	R1V	3,000	-40°C to +85°C
ADR540BRT-R2	4.096	8	40	3-Lead SOT-23-3	RT-3	RTB	250	-40°C to +85°C
ADR540BRT-REEL7	4.096	8	40	3-Lead SOT-23-3	RT-3	RTB	3,000	-40°C to +85°C
ADR540BRTZ-REEL7 ¹	4.096	8	40	3 Lead SOT-23-3	RT-3	R1V	3,000	-40°C to +85°C
ADR550ART-R2	5.0	20	70	3-Lead SOT-23-3	RT-3	RVA	250	-40°C to +85°C
ADR550ART-REEL7	5.0	20	70	3-Lead SOT-23-3	RT-3	RVA	3,000	-40°C to +85°C
ADR550ARTZ-REEL7 ¹	5.0	20	70	3-Lead SOT-23-3	RT-3	R1Q	3,000	-40°C to +85°C
ADR550BKS-R2	5.0	10	40	3-Lead SC70	KS-3	RVB	250	-40°C to +85°C
ADR550BKS-REEL7	5.0	10	40	3-Lead SC70	KS-3	RVB	3,000	-40°C to +85°C
ADR550BKSZ-REEL7 ¹	5.0	10	40	3-Lead SC70	KS-3	R1P	3,000	-40°C to +85°C
ADR550BRT-R2	5.0	10	40	3-Lead SOT-23-3	RT-3	RVB	250	-40°C to +85°C
ADR550BRT-REEL7	5.0	10	40	3-Lead SOT-23-3	RT-3	RVB	3,000	-40°C to +85°C
ADR550BRTZ-REEL7 ¹	5.0	10	40	3-Lead SOT-23-3	RT-3	R1P	3,000	-40°C to +85°C

¹ Z = RoHS Compliant Part.

NOTES

ADR520/ADR525/ADR530/ADR540/ADR550

NOTES



Компания «ЭлектроПласт» предлагает заключение долгосрочных отношений при поставках импортных электронных компонентов на взаимовыгодных условиях!

Наши преимущества:

- Оперативные поставки широкого спектра электронных компонентов отечественного и импортного производства напрямую от производителей и с крупнейших мировых складов;
- Поставка более 17-ти миллионов наименований электронных компонентов;
- Поставка сложных, дефицитных, либо снятых с производства позиций;
- Оперативные сроки поставки под заказ (от 5 рабочих дней);
- Экспресс доставка в любую точку России;
- Техническая поддержка проекта, помощь в подборе аналогов, поставка прототипов;
- Система менеджмента качества сертифицирована по Международному стандарту ISO 9001;
- Лицензия ФСБ на осуществление работ с использованием сведений, составляющих государственную тайну;
- Поставка специализированных компонентов (Xilinx, Altera, Analog Devices, Intersil, Interpoint, Microsemi, Aeroflex, Peregrine, Syfer, Eurofarad, Texas Instrument, Miteq, Cobham, E2V, MA-COM, Hittite, Mini-Circuits, General Dynamics и др.);

Помимо этого, одним из направлений компании «ЭлектроПласт» является направление «Источники питания». Мы предлагаем Вам помощь Конструкторского отдела:

- Подбор оптимального решения, техническое обоснование при выборе компонента;
- Подбор аналогов;
- Консультации по применению компонента;
- Поставка образцов и прототипов;
- Техническая поддержка проекта;
- Защита от снятия компонента с производства.



Как с нами связаться

Телефон: 8 (812) 309 58 32 (многоканальный)

Факс: 8 (812) 320-02-42

Электронная почта: org@eplast1.ru

Адрес: 198099, г. Санкт-Петербург, ул. Калинина, дом 2, корпус 4, литера А.